



Main

Range of product	Modicon M168 logic controller
Product or component type	Application-specific expansion module
Product specific application	Control of electronic expansion valve
Connector type	Screw terminal block

Complementary

Discrete input number	1 input
Contacts usage	Free contact
Discrete input voltage	230 V
Discrete input voltage type	AC
Sensor power supply	110...260 V AC
Voltage state 1 guaranteed	> 100 V for input
Voltage state 0 guaranteed	< 60 V for input
Input impedance	100000 Ohm
Discrete output voltage	250 V AC
Discrete output current	5000 mA
Display type	Four 7-segment display units
Mounting support	35 mm symmetrical DIN rail
Width	2.76 in (70 mm)
Height	6.22 in (158 mm)
Depth	2.4 in (61 mm)
Product weight	0.71 lb(US) (0.323 kg)

Environment

standards	2004/108/EC 2006/95/EEC EN 60730-1 EN 61000-6-1 EN 61000-6-3
product certifications	WEEE REACH
marking	CE
ambient air temperature for operation	32...122 °F (0...50 °C)
ambient air temperature for storage	-4...149 °F (-20...65 °C)
relative humidity	5...95 % without condensation
IP degree of protection	IP20
pollution degree	2
overvoltage category	III
operating altitude	0...6561.68 ft (0...2000 m)
vibration resistance	1 gn, amplitude: 3.5 mm (f = 5...150 Hz)
shock resistance	15 gn 11 ms

Offer Sustainability

Green Premium product	Green Premium product
Compliant - since 1039 - Schneider Electric declaration of conformity	Compliant - since 1039 - Schneider Electric declaration of conformity
Reference not containing SVHC above the threshold	Reference not containing SVHC above the threshold
Available	Available
Available	Available

Contractual warranty

Warranty period	18 months
-----------------	-----------

Electronic Expansion Valve Module

Dimensions

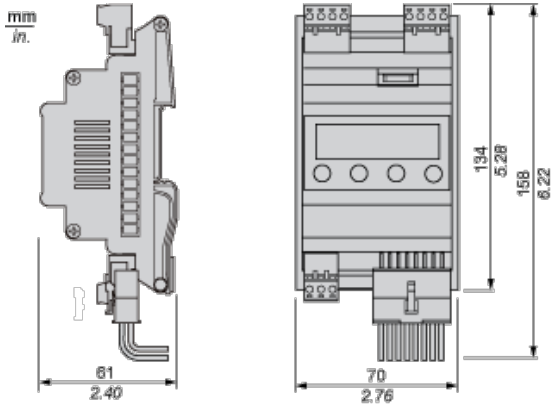

Mounting and Clearance

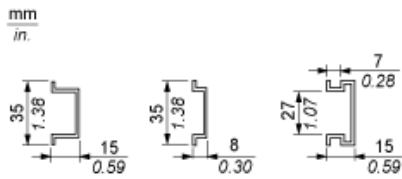

Mounting

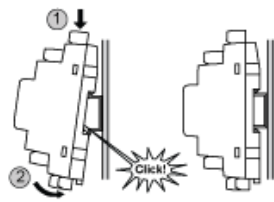

Dismounting

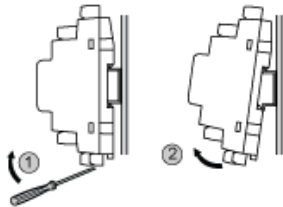

Misplacement

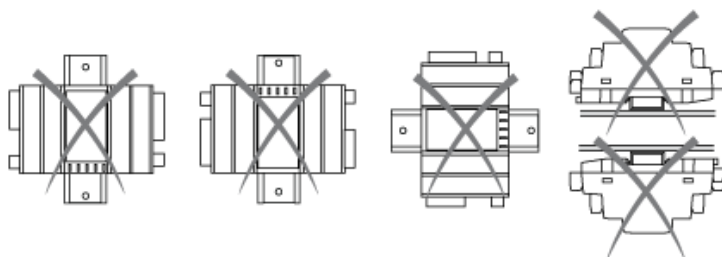

Electronic Expansion Valve Module

Electrical Connections

Module connections

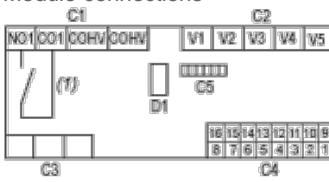

(1) Max. 3 A

C1: Connector 1

C2: Connector 2

C3: Connector 3

C4: Connector 4

C5: Connector 5

D1: Dipswitch 1

Connector 1: digital output and high voltage digital input.

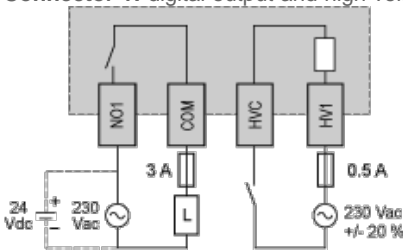

(4 poles male terminal block pitch 5.0 mm (0.196 in))

Connector 2: Alco Controls electronic expansion valve connection (5 poles male terminal block pitch 5.0 mm (0.196 in))

Connector 3: reserved.

Dipswitch 1: micro-switches 1 and 2 are reserved (must be in ON position).

Connector 4: (16 poles male Minifit connector)

PIN	MEANING
1	power supply input (24 Vac/dc)
2	common for analog and low voltage digital inputs
3	
4	
5	not connected
6	not connected
7	analog input 2 (suction temperature sensor; NTC)
8	analog input 1 (evaporation pressure sensor; 4-20 mA)
9	power supply input (24 Vac/dc)
10	input power supply coming from the TM168AVCM battery backup module (12 Vdc)
11	power supply pressure transducer (12 Vdc)
12	not connected
13	not connected
14	not connected
15	low voltage digital input 1 (enable)
16	low voltage digital input 2 (backup battery loading status)

The power supply coming from the TM168AVCM battery backup module has sufficient power to support the closing of the valve during a power outage.

Connector 5: TTL serial port (6 poles Micromatch connector) with Modbus communication protocol (use TM168AVCMCOM, see wiring diagram below).

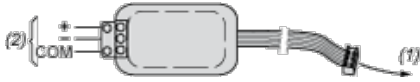

(1) To connector 5

(2) 3 screw terminals

PIN	RS485 SIGNAL
+	D1 (A+)
-	D0 (B-)
COM	0 V

Wiring Recommendations

The maximum lengths of the connected cables are the followings

- | power supply: 1 m (3.280 ft)
- | analog inputs: 3 m (9.842 ft)
- | digital inputs: 3 m (9.842 ft)
- | digital outputs: 10 m (32.808 ft)
- | electronic expansion valve: 6 m (19.685 ft)

Данный компонент на территории Российской Федерации

Вы можете приобрести в компании MosChip.

Для оперативного оформления запроса Вам необходимо перейти по данной ссылке:

<http://moschip.ru/get-element>

Вы можете разместить у нас заказ для любого Вашего проекта, будь то серийное производство или разработка единичного прибора.

В нашем ассортименте представлены ведущие мировые производители активных и пассивных электронных компонентов.

Нашей специализацией является поставка электронной компонентной базы двойного назначения, продукции таких производителей как XILINX, Intel (ex.ALTERA), Vicor, Microchip, Texas Instruments, Analog Devices, Mini-Circuits, Amphenol, Glenair.

Сотрудничество с глобальными дистрибьюторами электронных компонентов, предоставляет возможность заказывать и получать с международных складов практически любой перечень компонентов в оптимальные для Вас сроки.

На всех этапах разработки и производства наши партнеры могут получить квалифицированную поддержку опытных инженеров.

Система менеджмента качества компании отвечает требованиям в соответствии с ГОСТ Р ИСО 9001, ГОСТ РВ 0015-002 и ЭС РД 009

Офис по работе с юридическими лицами:

105318, г.Москва, ул.Щербаковская д.3, офис 1107, 1118, ДЦ «Щербаковский»

Телефон: +7 495 668-12-70 (многоканальный)

Факс: +7 495 668-12-70 (доб.304)

E-mail: info@moschip.ru

Skype отдела продаж:

moschip.ru

moschip.ru_4

moschip.ru_6

moschip.ru_9