

NTLUS3A40PZ

Power MOSFET

-20 V, -9.4 A, μ Cool™ Single P-Channel, ESD, 2.0x2.0x0.55 mm UDFN Package

Features

- UDFN Package with Exposed Drain Pads for Excellent Thermal Conduction
- Low Profile UDFN 2.0x2.0x0.55 mm for Board Space Saving
- Lowest RDS(on) in 2.0x2.0 Package
- ESD Protected
- These Devices are Pb-Free, Halogen Free/BFR Free and are RoHS Compliant

Applications

- High Side Load Switch
- PA Switch and Battery Switch
- Optimized for Power Management Applications for Portable Products, such as Cell Phones, PMP, DSC, GPS, and others

MAXIMUM RATINGS (T_J = 25°C unless otherwise stated)

| Parameter | | Symbol | Value | Units | |
|---|--------------|-----------------------------------|----------------|-------|---|
| Drain-to-Source Voltage | | V _{DSS} | -20 | V | |
| Gate-to-Source Voltage | | V _{GS} | ±8.0 | V | |
| Continuous Drain Current (Note 1) | Steady State | T _A = 25°C | I _D | -6.4 | A |
| | | T _A = 85°C | | -4.6 | |
| | t ≤ 5 s | T _A = 25°C | | -9.4 | |
| Power Dissipation (Note 1) | Steady State | T _A = 25°C | P _D | 1.7 | W |
| | | T _A = 25°C | | 3.8 | |
| Continuous Drain Current (Note 2) | Steady State | T _A = 25°C | I _D | -4.0 | A |
| | | T _A = 85°C | | -2.9 | |
| Power Dissipation (Note 2) | | T _A = 25°C | P _D | 0.7 | W |
| Pulsed Drain Current | tp = 10 μs | I _{DM} | -30 | A | |
| Operating Junction and Storage Temperature | | T _J , T _{STG} | -55 to 150 | °C | |
| Source Current (Body Diode) (Note 2) | | I _S | -1.0 | A | |
| Lead Temperature for Soldering Purposes (1/8" from case for 10 s) | | T _L | 260 | °C | |
| ESD Rating (HBM) per JEDEC22-A114F | | ESD | >2000 | V | |

Stresses exceeding Maximum Ratings may damage the device. Maximum Ratings are stress ratings only. Functional operation above the Recommended Operating Conditions is not implied. Extended exposure to stresses above the Recommended Operating Conditions may affect device reliability.

1. Surface Mounted on FR4 Board using 1 in sq pad size (Cu area = 1.127 in sq [2 oz] including traces).
2. Surface-mounted on FR4 board using the minimum recommended pad size of 30 mm², 2 oz. Cu.



ON Semiconductor®

<http://onsemi.com>

MOSFET

| V _{(BR)DSS} | R _{DS(on)} MAX | I _D MAX |
|----------------------|-------------------------|--------------------|
| -20 V | 29 mΩ @ -4.5 V | -9.4 A |
| | 39 mΩ @ -2.5 V | |
| | 60 mΩ @ -1.8 V | |
| | 120 mΩ @ -1.5 V | |

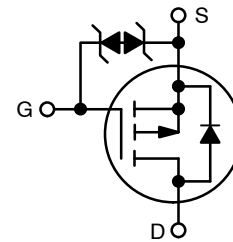

P-Channel MOSFET

MARKING DIAGRAM

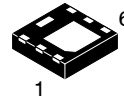

UDFN6
CASE 517BG
 μ COOL™

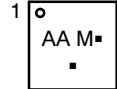

AA = Specific Device Code
M = Date Code
▪ = Pb-Free Package

(Note: Microdot may be in either location)

PIN CONNECTIONS

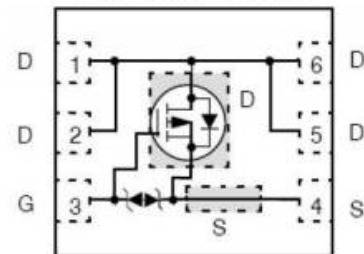

(Top View)

ORDERING INFORMATION

See detailed ordering and shipping information in the package dimensions section on page 5 of this data sheet.

NTLUS3A40PZ

THERMAL RESISTANCE RATINGS

| Parameter | Symbol | Max | Units |
|---|-----------------|-----|-------|
| Junction-to-Ambient – Steady State (Note 3) | $R_{\theta JA}$ | 72 | °C/W |
| Junction-to-Ambient – $t \leq 5$ s (Note 3) | $R_{\theta JA}$ | 33 | |
| Junction-to-Ambient – Steady State min Pad (Note 4) | $R_{\theta JA}$ | 189 | |

ELECTRICAL CHARACTERISTICS ($T_J = 25^\circ\text{C}$ unless otherwise specified)

| Parameter | Symbol | Test Condition | Min | Typ | Max | Units |
|-----------|--------|----------------|-----|-----|-----|-------|
|-----------|--------|----------------|-----|-----|-----|-------|

OFF CHARACTERISTICS

| | | | | | | |
|---|-------------------|---|--------------------------|------|----------|---------------|
| Drain-to-Source Breakdown Voltage | $V_{(BR)DSS}$ | $V_{GS} = 0\text{ V}, I_D = -250\ \mu\text{A}$ | -20 | | | V |
| Drain-to-Source Breakdown Voltage Temperature Coefficient | $V_{(BR)DSS}/T_J$ | $I_D = -250\ \mu\text{A}$, ref to 25°C | | -5.0 | | mV/°C |
| Zero Gate Voltage Drain Current | I_{DSS} | $V_{GS} = 0\text{ V}, V_{DS} = -20\text{ V}$ | $T_J = 25^\circ\text{C}$ | | -1.0 | μA |
| | | | $T_J = 85^\circ\text{C}$ | | -10 | |
| Gate-to-Source Leakage Current | I_{GSS} | $V_{DS} = 0\text{ V}, V_{GS} = \pm 8.0\text{ V}$ | | | ± 10 | μA |

ON CHARACTERISTICS (Note 5)

| | | | | | | |
|--------------------------------------|------------------|---|------|-----|------|------------|
| Gate Threshold Voltage | $V_{GS(TH)}$ | $V_{GS} = V_{DS}, I_D = -250\ \mu\text{A}$ | -0.4 | | -1.0 | V |
| Negative Threshold Temp. Coefficient | $V_{GS(TH)}/T_J$ | | | 3.0 | | mV/°C |
| Drain-to-Source On Resistance | $R_{DS(on)}$ | $V_{GS} = -4.5\text{ V}, I_D = -6.4\text{ A}$ | | 23 | 29 | m Ω |
| | | $V_{GS} = -2.5\text{ V}, I_D = -4.8\text{ A}$ | | 31 | 39 | |
| | | $V_{GS} = -1.8\text{ V}, I_D = -2.5\text{ A}$ | | 43 | 60 | |
| | | $V_{GS} = -1.5\text{ V}, I_D = -1.5\text{ A}$ | | 60 | 120 | |
| Forward Transconductance | g_{FS} | $V_{DS} = -15\text{ V}, I_D = -4.0\text{ A}$ | | 18 | | S |

CHARGES, CAPACITANCES & GATE RESISTANCE

| | | | | | | |
|------------------------------|--------------|--|--|------|--|----|
| Input Capacitance | C_{ISS} | $V_{GS} = 0\text{ V}, f = 1\text{ MHz}, V_{DS} = -15\text{ V}$ | | 2600 | | pF |
| Output Capacitance | C_{OSS} | | | 200 | | |
| Reverse Transfer Capacitance | C_{RSS} | | | 190 | | |
| Total Gate Charge | $Q_{G(TOT)}$ | $V_{GS} = -4.5\text{ V}, V_{DS} = -15\text{ V}; I_D = -4.0\text{ A}$ | | 29 | | nC |
| Threshold Gate Charge | $Q_{G(TH)}$ | | | 1.4 | | |
| Gate-to-Source Charge | Q_{GS} | | | 3.7 | | |
| Gate-to-Drain Charge | Q_{GD} | | | 8.1 | | |

SWITCHING CHARACTERISTICS, $V_{GS} = 4.5\text{ V}$ (Note 6)

| | | | | | | |
|---------------------|--------------|---|--|-----|--|----|
| Turn-On Delay Time | $t_{d(ON)}$ | $V_{GS} = -4.5\text{ V}, V_{DD} = -15\text{ V}, I_D = -4.0\text{ A}, R_G = 1\ \Omega$ | | 9.0 | | ns |
| Rise Time | t_r | | | 18 | | |
| Turn-Off Delay Time | $t_{d(OFF)}$ | | | 126 | | |
| Fall Time | t_f | | | 71 | | |

DRAIN-SOURCE DIODE CHARACTERISTICS

| | | | | | | | |
|-------------------------|----------|---|---------------------------|------|------|-----|---|
| Forward Diode Voltage | VSD | $V_{GS} = 0\text{ V}, I_S = -1.0\text{ A}$ | $T_J = 25^\circ\text{C}$ | | 0.65 | 1.0 | V |
| | | | $T_J = 125^\circ\text{C}$ | | 0.55 | | |
| Reverse Recovery Time | t_{RR} | $V_{GS} = 0\text{ V}, \text{dis}/\text{dt} = 100\text{ A}/\mu\text{s}, I_S = -1.0\text{ A}$ | | 25 | | ns | |
| Charge Time | t_a | | | 10 | | | |
| Discharge Time | t_b | | | 15 | | | |
| Reverse Recovery Charge | Q_{RR} | | | 13.6 | | nC | |

- Surface-mounted on FR4 board using 1 in sq pad size (Cu area = 1.127 in sq [2 oz] including traces).
- Surface-mounted on FR4 board using the minimum recommended pad size of 30 mm², 2 oz. Cu.
- Pulse Test: pulse width $\leq 300\ \mu\text{s}$, duty cycle $\leq 2\%$.
- Switching characteristics are independent of operating junction temperatures.

NTLUS3A40PZ

TYPICAL CHARACTERISTICS

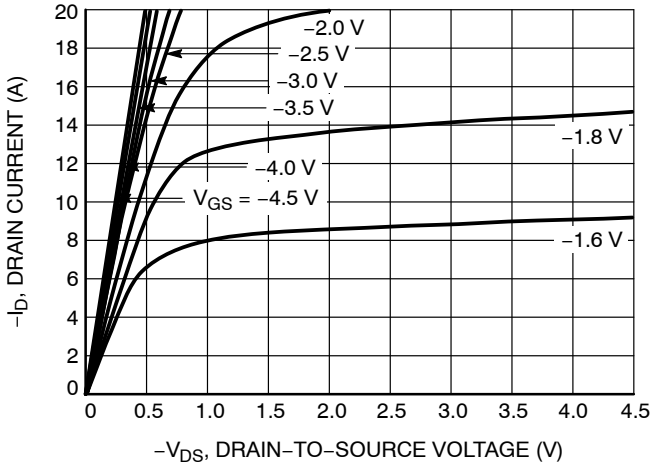

Figure 1. On-Region Characteristics

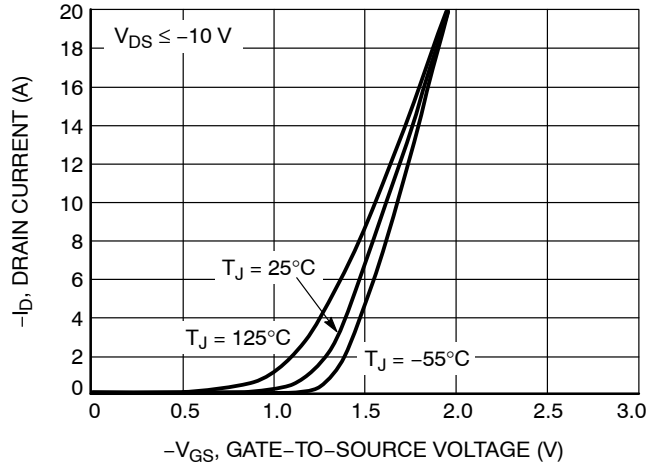

Figure 2. Transfer Characteristics

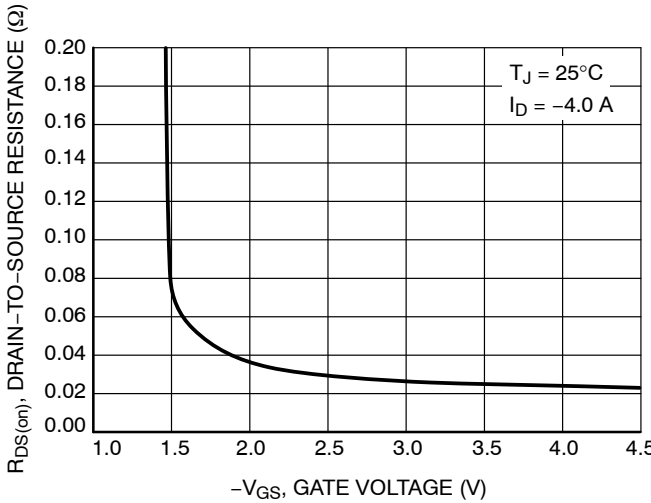

Figure 3. On-Resistance vs. Gate-to-Source Voltage

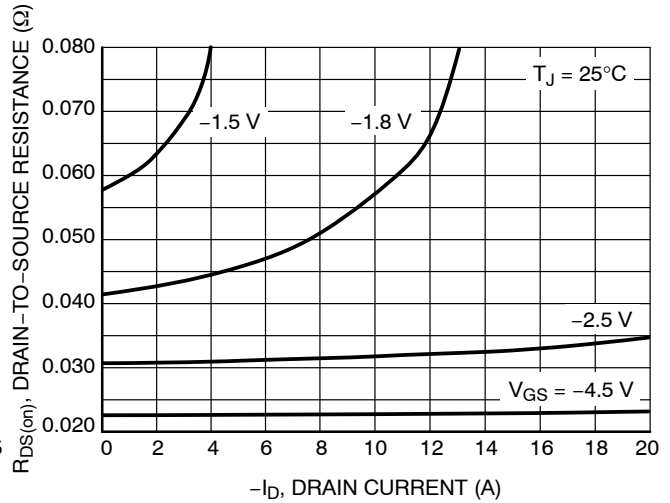

Figure 4. On-Resistance vs. Drain Current and Gate Voltage

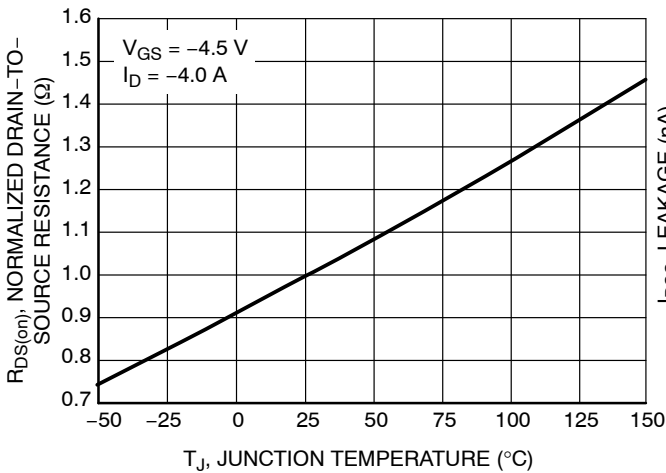

Figure 5. On-Resistance Variation with Temperature

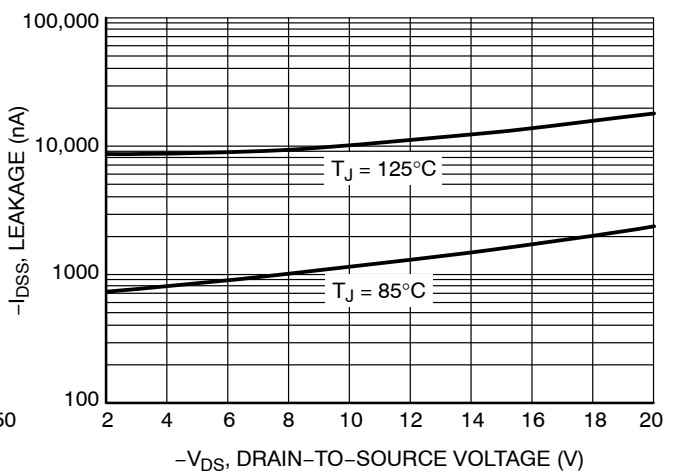

Figure 6. Drain-to-Source Leakage Current vs. Voltage

NTLUS3A40PZ

TYPICAL CHARACTERISTICS

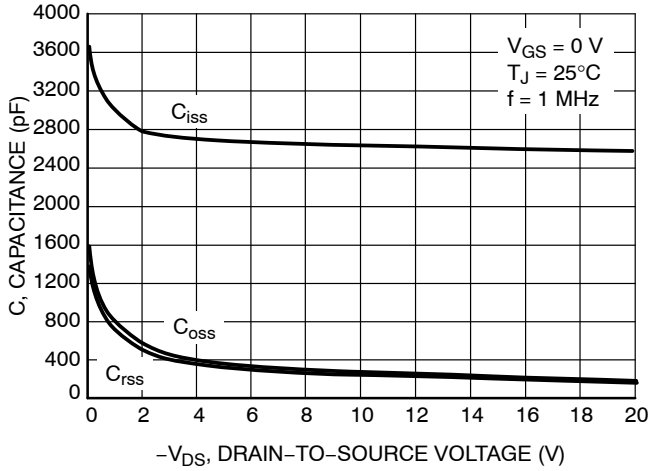

Figure 7. Capacitance Variation

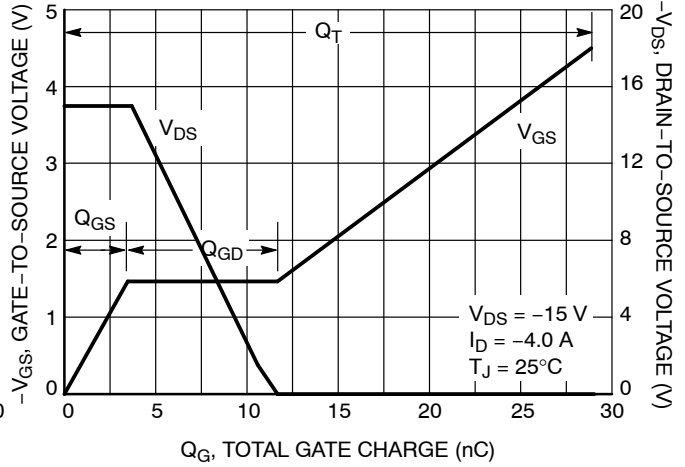

Figure 8. Gate-to-Source and Drain-to-Source Voltage vs. Total Charge

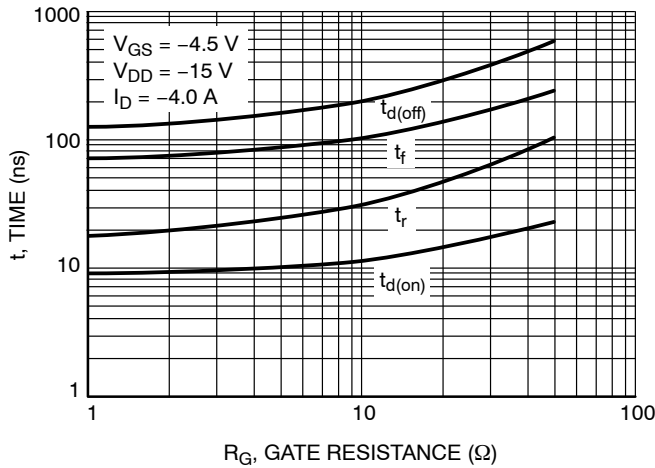

Figure 9. Resistive Switching Time Variation vs. Gate Resistance

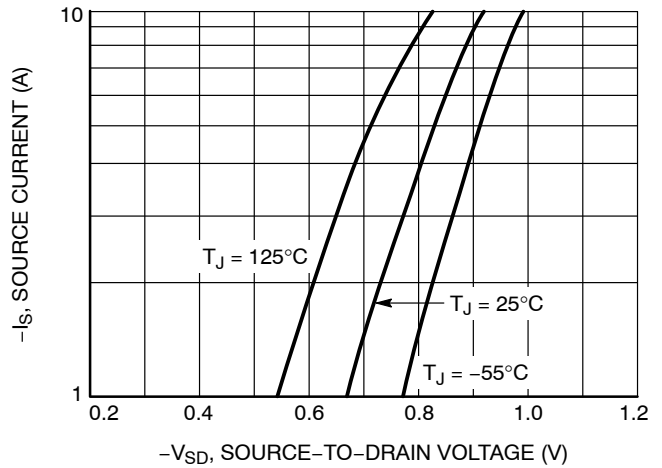

Figure 10. Diode Forward Voltage vs. Current

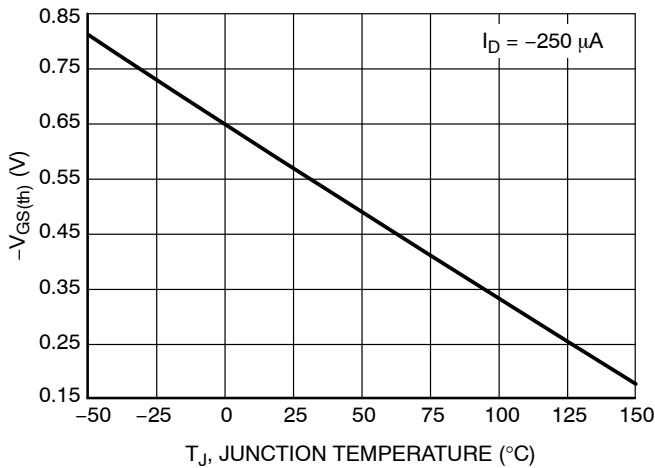

Figure 11. Threshold Voltage

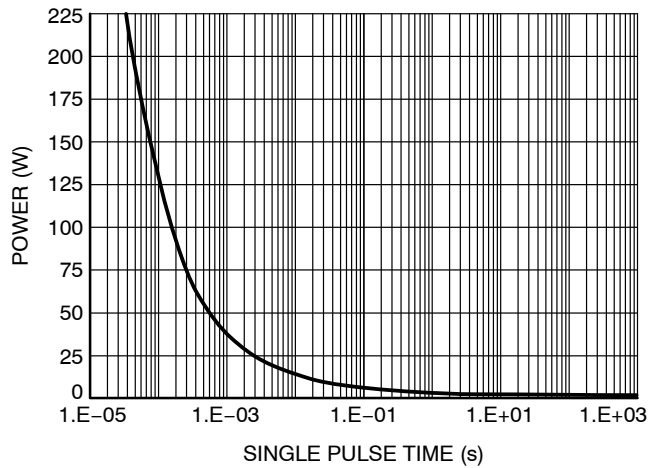

Figure 12. Single Pulse Maximum Power Dissipation

NTLUS3A40PZ

TYPICAL CHARACTERISTICS

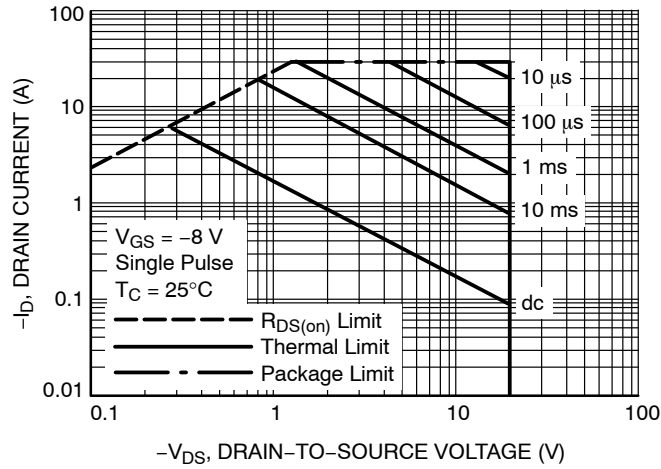

Figure 13. Maximum Rated Forward Biased Safe Operating Area

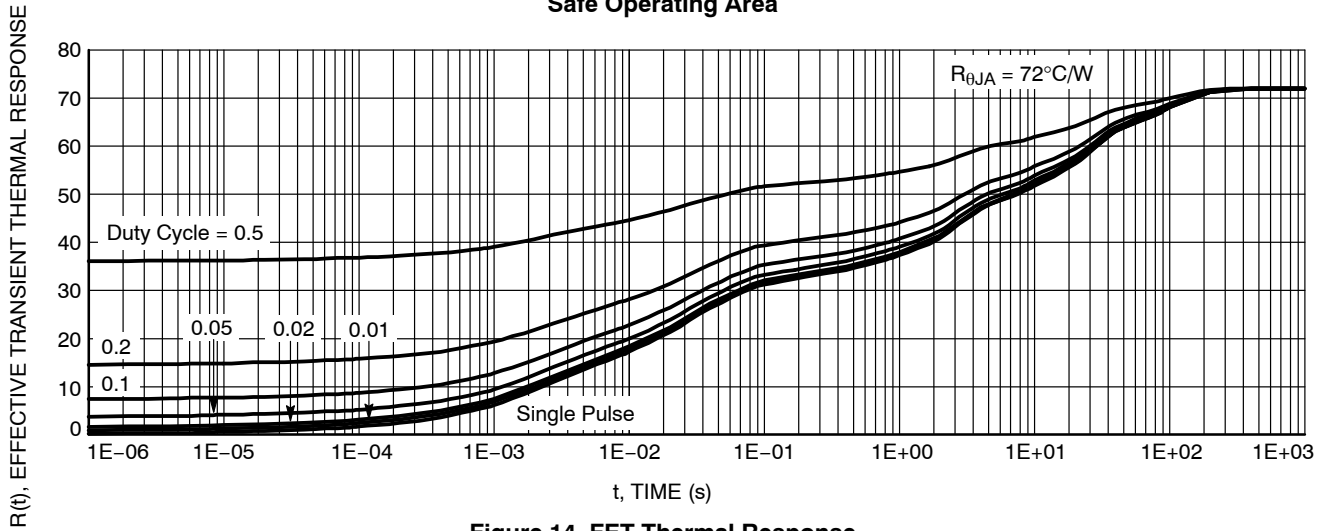

Figure 14. FET Thermal Response

DEVICE ORDERING INFORMATION

| Device | Package | Shipping [†] |
|----------------|--------------------|-----------------------|
| NTLUS3A40PZTAG | UDFN6 (Pb-Free) | 3000 / Tape & Reel |
| NTLUS3A40PZTBG | UDFN6 (Pb-Free) | 3000 / Tape & Reel |

[†]For information on tape and reel specifications, including part orientation and tape sizes, please refer to our Tape and Reel Packaging Specifications Brochure, BRD8011/D.

NTLUS3A40PZ

PACKAGE DIMENSIONS

UDFN6 2x2, 0.65P
CASE 517BG-01
ISSUE O

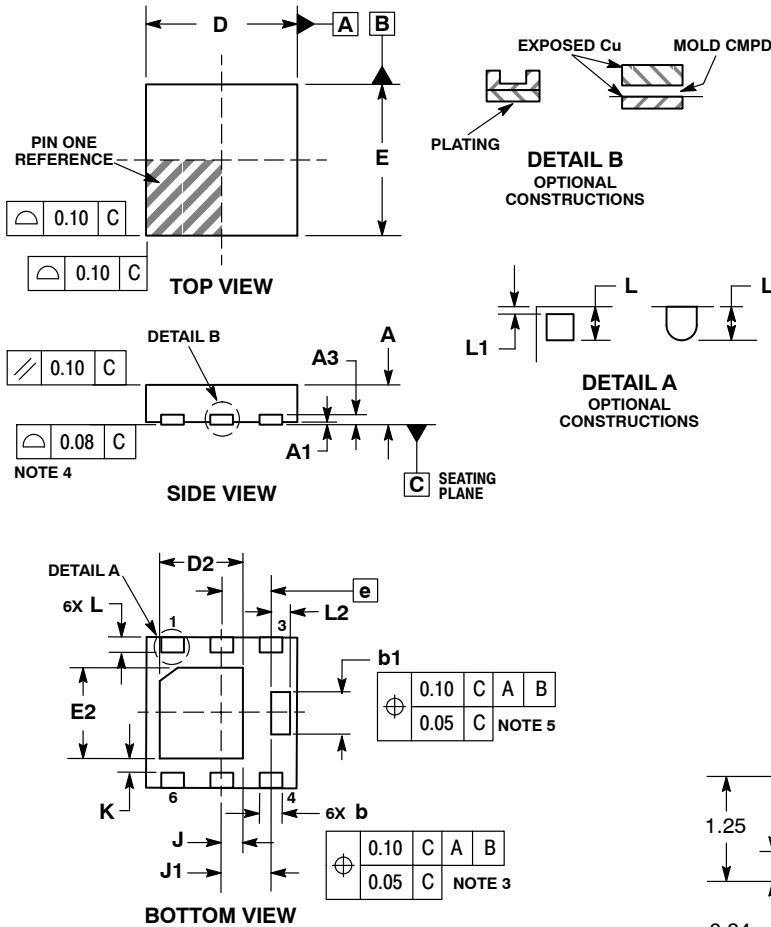

NOTES:

1. DIMENSIONING AND TOLERANCING PER ASME Y14.5M, 1994.
2. CONTROLLING DIMENSION: MILLIMETERS.
3. DIMENSION b APPLIES TO PLATED TERMINAL AND IS MEASURED BETWEEN 0.15 AND 0.30 mm FROM TERMINAL.
4. COPLANARITY APPLIES TO THE EXPOSED PAD AS WELL AS THE TERMINALS.
5. CENTER TERMINAL LEAD IS OPTIONAL. CENTER TERMINAL IS CONNECTED TO TERMINAL LEAD # 4.
6. LEADS 1, 2, 5 AND 6 ARE TIED TO THE FLAG.

| DIM | MILLIMETERS | |
|-----|-------------|------|
| | MIN | MAX |
| A | 0.45 | 0.55 |
| A1 | 0.00 | 0.05 |
| A3 | 0.13 REF | |
| b | 0.25 | 0.35 |
| b1 | 0.51 | 0.61 |
| D | 2.00 BSC | |
| D2 | 1.00 | 1.20 |
| E | 2.00 BSC | |
| E2 | 1.10 | 1.30 |
| e | 0.65 BSC | |
| K | 0.15 REF | |
| J | 0.27 BSC | |
| J1 | 0.65 BSC | |
| L | 0.20 | 0.30 |
| L1 | --- | 0.10 |
| L2 | 0.20 | 0.30 |

RECOMMENDED MOUNTING FOOTPRINT

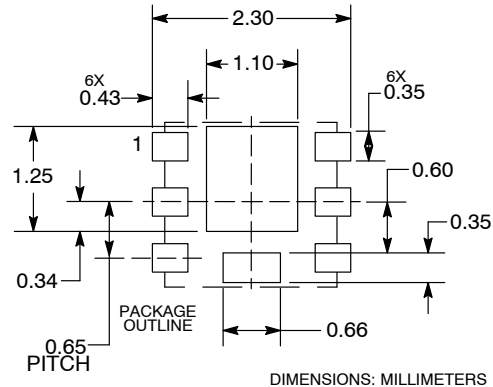

µCool is a trademark of Semiconductor Components Industries, LLC (SCILLC).

ON Semiconductor and are registered trademarks of Semiconductor Components Industries, LLC (SCILLC). SCILLC reserves the right to make changes without further notice to any products herein. SCILLC makes no warranty, representation or guarantee regarding the suitability of its products for any particular purpose, nor does SCILLC assume any liability arising out of the application or use of any product or circuit, and specifically disclaims any and all liability, including without limitation special, consequential or incidental damages. "Typical" parameters which may be provided in SCILLC data sheets and/or specifications can and do vary in different applications and actual performance may vary over time. All operating parameters, including "Typicals" must be validated for each customer application by customer's technical experts. SCILLC does not convey any license under its patent rights nor the rights of others. SCILLC products are not designed, intended, or authorized for use as components in systems intended for surgical implant into the body, or other applications intended to support or sustain life, or for any other application in which the failure of the SCILLC product could create a situation where personal injury or death may occur. Should Buyer purchase or use SCILLC products for any such unintended or unauthorized application, Buyer shall indemnify and hold SCILLC and its officers, employees, subsidiaries, affiliates, and distributors harmless against all claims, costs, damages, and expenses, and reasonable attorney fees arising out of, directly or indirectly, any claim of personal injury or death associated with such unintended or unauthorized use, even if such claim alleges that SCILLC was negligent regarding the design or manufacture of the part. SCILLC is an Equal Opportunity/Affirmative Action Employer. This literature is subject to all applicable copyright laws and is not for resale in any manner.

PUBLICATION ORDERING INFORMATION

LITERATURE FULFILLMENT:
Literature Distribution Center for ON Semiconductor
P.O. Box 5163, Denver, Colorado 80217 USA
Phone: 303-675-2175 or 800-344-3860 Toll Free USA/Canada
Fax: 303-675-2176 or 800-344-3867 Toll Free USA/Canada
Email: orderlit@onsemi.com

N. American Technical Support: 800-282-9855 Toll Free
USA/Canada
Europe, Middle East and Africa Technical Support:
Phone: 421 33 790 2910
Japan Customer Focus Center
Phone: 81-3-5773-3850

ON Semiconductor Website: www.onsemi.com

Order Literature: <http://www.onsemi.com/orderlit>

For additional information, please contact your local Sales Representative

Данный компонент на территории Российской Федерации

Вы можете приобрести в компании MosChip.

Для оперативного оформления запроса Вам необходимо перейти по данной ссылке:

<http://moschip.ru/get-element>

Вы можете разместить у нас заказ для любого Вашего проекта, будь то серийное производство или разработка единичного прибора.

В нашем ассортименте представлены ведущие мировые производители активных и пассивных электронных компонентов.

Нашей специализацией является поставка электронной компонентной базы двойного назначения, продукции таких производителей как XILINX, Intel (ex.ALTERA), Vicor, Microchip, Texas Instruments, Analog Devices, Mini-Circuits, Amphenol, Glenair.

Сотрудничество с глобальными дистрибьюторами электронных компонентов, предоставляет возможность заказывать и получать с международных складов практически любой перечень компонентов в оптимальные для Вас сроки.

На всех этапах разработки и производства наши партнеры могут получить квалифицированную поддержку опытных инженеров.

Система менеджмента качества компании отвечает требованиям в соответствии с ГОСТ Р ИСО 9001, ГОСТ РВ 0015-002 и ЭС РД 009

Офис по работе с юридическими лицами:

105318, г.Москва, ул.Щербаковская д.3, офис 1107, 1118, ДЦ «Щербаковский»

Телефон: +7 495 668-12-70 (многоканальный)

Факс: +7 495 668-12-70 (доб.304)

E-mail: info@moschip.ru

Skype отдела продаж:

moschip.ru

moschip.ru_4

moschip.ru_6

moschip.ru_9