

SERIES 08
SERIES 09
0.5" Diameter, 1/4 Amp,
Standard, Military SR13

FEATURES

- Proven Quality in Thousands of Applications
- Gold-plated Contact System
- 30°, 36°, 45°, 60° and 90° Angle of Throw Options
- MIL Qualified Versions MIL-S-3786/13



DIMENSIONS in inches (and millimeters)

Standard Style

Front view shows terminal location of Series 8, 36° angle of throw. Transpose rear view for terminal location of other angles of throw.

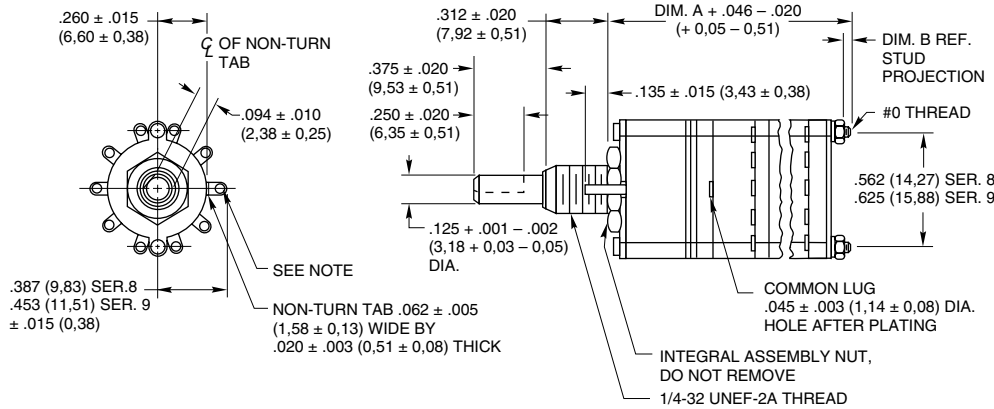

Note: Common location for a single pole per deck switch. For common location on multi-pole switches, see circuit diagrams.

No. of Decks	Dimension A	Dimension B	Approx. Weight Grams		No. of Decks	Dimension A	Dimension B	Approx. Weight Grams	
			Srs. 08	Srs. 09				Srs. 08	Srs. 09
1	.960 (24,38)	.062 (1,57)	12	16.0	7	2.818 (71,58)	.312 (7,92)	24	31.0
2	1.228 (31,19)	.062 (1,57)	14	18.5	8	3.086 (78,38)	.312 (7,92)	26	33.5
3	1.496 (38,00)	.062 (1,57)	16	21.0	9	3.354 (85,19)	.312 (7,92)	28	36.0
4	1.764 (44,81)	.062 (1,57)	18	23.5	10	3.622 (91,00)	.312 (7,92)	30	38.5
5	2.032 (51,61)	.062 (1,57)	20	26.0	11	3.890 (98,81)	.312 (7,92)	32	41.0
6	2.550 (64,77)	.312 (7,92)	22	28.5	12	4.158 (105,61)	.312 (7,92)	34	43.5

Grayhill part number and date code marked on standard style detent cover label. Customer part number marked on request. Grayhill part number and date code printed on military style cover. Military number printed when required.

Rear Views

Series 09
30° Angle of Throw

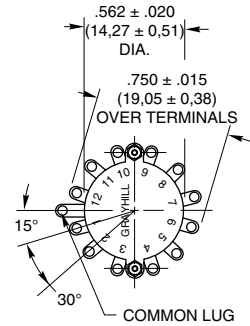

Series 08
36° Angle of Throw

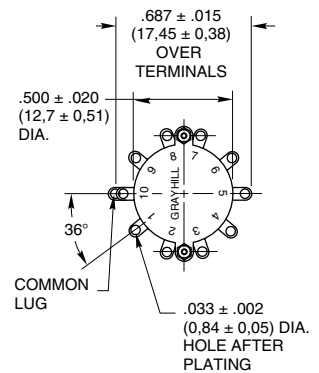

For rear view of 45°, 60° and 90°, see circuit diagrams.

CIRCUIT DIAGRAMS: Solder Lug Terminals

Switch is Viewed From Shaft End and Shown in Position No. 1

Note: All common terminals are located above base terminals as shown.

**Series 09
30° Angle
of Throw**

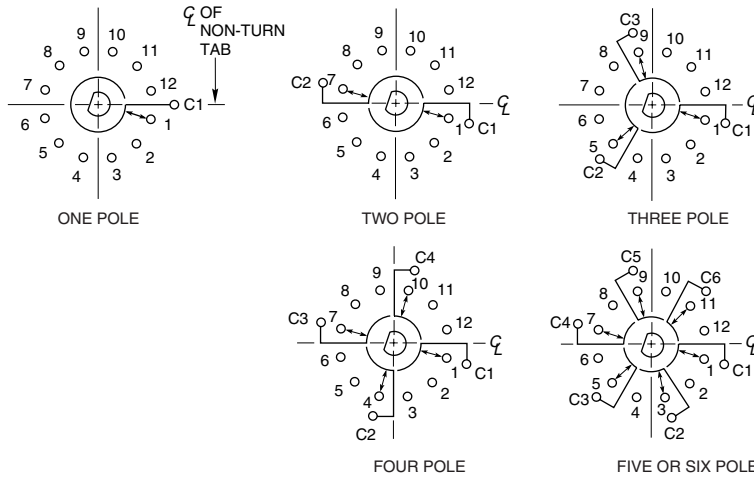

**Series 08
36° Angle
of Throw**

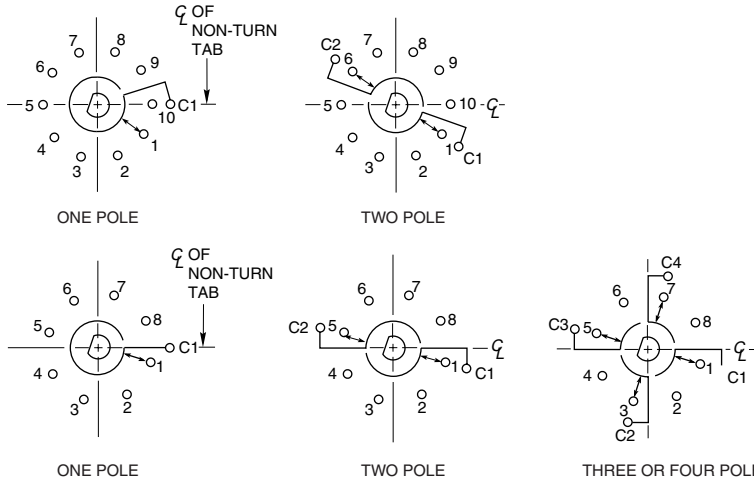

**Series 09
45° Angle
of Throw**

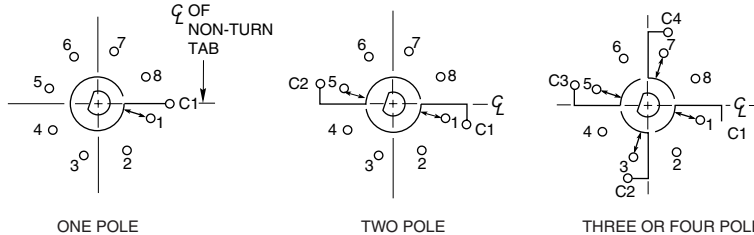

**Series 09
60° Angle
of Throw**

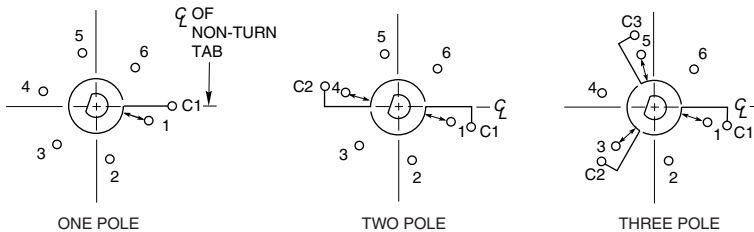

**Series 09
90° Angle
of Throw**

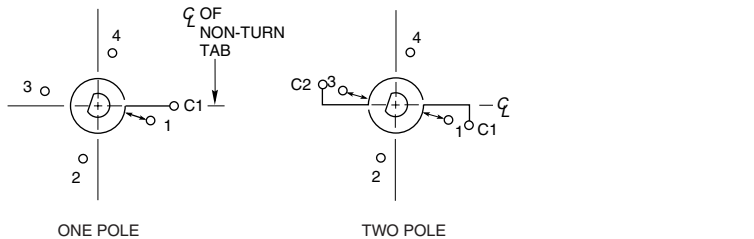

Rear Views

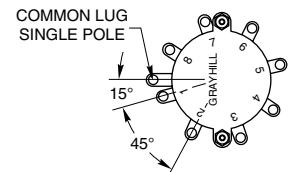

Rotary Switches

SERIES 08 SERIES 09 .5" Diameter, 1/4 Amp, PC Mount

FEATURES

- Gold-plated Contact System
- 30°, 36°, 60° or 90° Angle of Throw Options
- Compatible with Logic Level Voltages and Currents



DIMENSIONS in inches (and millimeters)

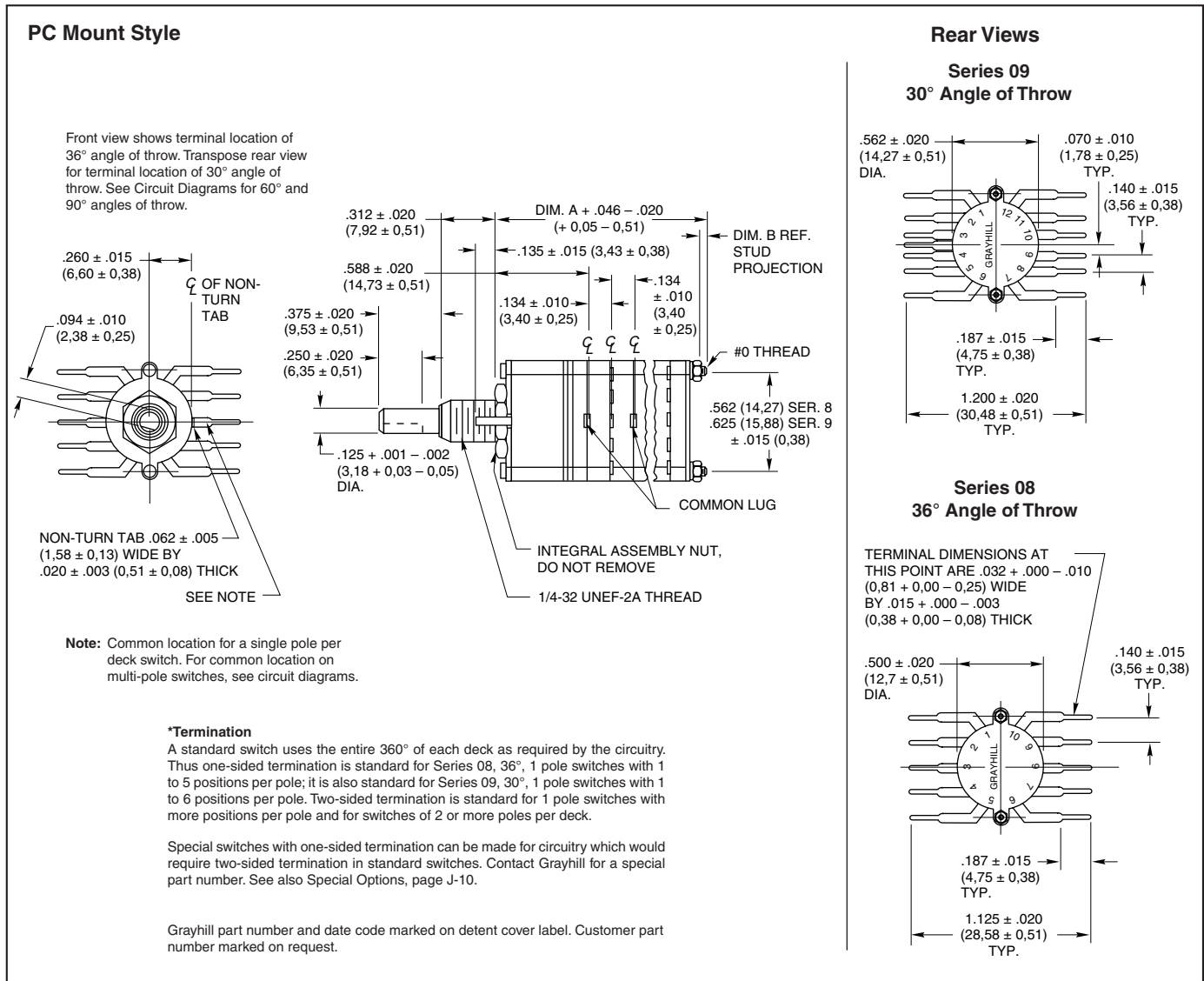

CIRCUIT DIAGRAMS: PC Mount



PC BOARD MOUNTING PATTERN



SHAFT AND PANEL SEAL

A shaft and panel seal is available to provide watertight mounting of the Series 08 and 09. Standard and Military Style rotary switches. Sealing is accomplished by O-ring shaft seal and panel seal washer. When the panel seal is compressed, dimensions are approximately the same as an unsealed switch. Sealed switches are provided with a double flat bushing. Non-turn feature can be accomplished by proper fit of this bushing into panel hole and/or by allowing non-turn tab to extend into (but not through) panel. Military Style rotary sealed switches do not have a non-turn tab.

Rotary Switches

MILITARY QUALIFIED

Series 08 and 09 military switches are qualified to MIL-DTL-3786/13. They include 30°, 36°, 45° and 60° angles of throw with solder lug terminals in sealed and unsealed styles. See front and rear views at right. Standard variations which do not affect switch performance can also be marked as qualified product—contact Grayhill.

The military style is dimensionally the same as the standard except for the solder lug. Convert standard style switch drawings to military style drawings by including this terminal detail and changing the over-terminal dimensions shown here. Grayhill can provide complete specification drawings. Qualified switches can be ordered by the Grayhill number or the "M" number; they will be marked per MIL-DTL-3786/13.

Front view shows terminal location of Series 09, 30° angle of throw. Transpose rear view for terminal location of other angles of throw.



Note: Common location for a single pole per deck switch. For common location on multi-pole switches, see circuit diagrams.

Series 09 30° Angle of Throw

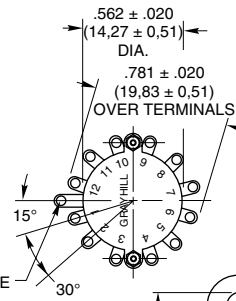

Series 08 36° Angle of Throw

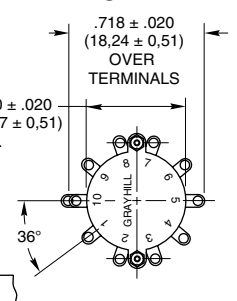

Terminal Detail

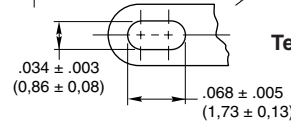

SPECIFICATIONS

Electrical Ratings

Standard Style

Rated: To make and break the following loads: 1/4 amp, 115 Vac resistive; 1/4 amp, 6-28 Vdc resistive; 20 mA, 115 Vdc resistive; 50 mA, 115 Vac inductive; 20 mA, 28 Vdc inductive; to carry 4 amps continuous.

Contact Resistance: After 25,000 cycles of operation, 50 milliohms maximum

Insulation Resistance: 1,000 megohms minimum between terminals and shaft

Voltage Breakdown: 1,000 Vac initially (500 Vac or better after most environmental tests)

Life Expectancy: 50,000 mechanical cycles of operation. *Note:* Actual life is determined by a number of factors, including electrical loading, rate of rotation and environment, as well as maximum contact resistance, minimum insulation resistance and minimum voltage breakdown required at the end of life.

Electrical Ratings

Military Qualified

Qualified to the following MIL-DTL-3786/13

Circuit Values: (Also see Standard Style description.) The Series 08M and 09M have been tested to meet the requirements of MIL-S-3786, Style SR13, the majority of which are listed. At 85°C, approximately 68% relative humidity and sea level pressure, the switches have been tested to make and break the following loads, as stated in MIL-DTL-3786/SR13: 125 milliamperes at 28 Vdc resistive; 75 milliamperes at 115 Vac resistive.

The switches have also been tested at reduced barometric pressure (70,000 feet), 25°C at approximately 68% relative humidity to make and break the following loads as stated in MIL-DTL-3786/SR13. 50 milliamperes 28 Vdc resistive; 20 milliamperes 115 Vac resistive. When tested to the above loads at the stated conditions, the Series 08M and 09M switches meet the following life-limiting criteria after 25,000 cycles of operation in accordance with

MIL-DTL-3786.

Contact Resistance: 50 milliohms maximum after life

Insulation Resistance: 1,000 megohms minimum between terminals and shaft

Dielectric Strength: 500 Vac (atmospheric pressure) and 350 Vac (reduced pressure) between mutually insulated parts.

The Series 08M and 09M also meet the requirements of MIL-DTL-3786 SR13 for moisture resistance, stop strength, rotational torque, vibration (10 to 2,000 cps), medium and high shock, salt spray, explosion, thermal shock (-65°C to 85°C) and terminal pull. When tested at sea level, 25°C and 68% relative humidity with failure criteria of 50 milliohms maximum contact resistance and 500 Vac breakdown voltage, these switches will make and break 250 mA at 28 Vdc inductive (250 millihenries): 1/2 amp: at 28 Vdc resistive; 1/2 amp; at 115 Vac: 60 Hz resistive for 10,000 cycles of operation.

Materials and Finishes

Standard Style

Switch Bases: Melamine per (MIL-M-14) ASTM-D-5948

Cover, Deck Separators and End Plate: Phenolic per (MIL-M-14) ASTM-D-5948

Rotor Mounting Plate: Thermoplastic

Mounting Bushing: Brass, tin/zinc-plated.

Shaft, Retaining Rings, Through Bolts, Shaft Extension, Stop Washers, Stop Arm, Thrust Washers, Nuts, Cover Plate and Rear Support Plate: Stainless steel

Detent Balls: Steel, nickel-plated

Detent Springs: Tinned Music wire

Terminals, Stator (Base) Contacts and Common Plate: Brass, gold plate .00001" minimum over silver plate .0003" minimum

Rotor Contact: Silver alloy, gold-plated .00001" minimum

Mounting Hardware: Two mounting nuts .062" (1,57) thick by .312" (7,92) across flats and one internal lockwasher are supplied with switch.

Lockwasher: Stainless steel

Mounting Nuts, Washers: Brass, tin/zinc-plated and or stainless steel.

Materials and Finishes

Military Qualified

Deck Separators, End Plate and Switch Bases: Diallyl per (MIL-M-14) ASTM-D-5948

Rotor Mounting Plate: Thermoplastic

Mounting Bushing: Brass, tin/zinc-plated.

Shaft, Cover, Stop Plate, Retaining Ring, Through Bolts, Shaft Extension, Stop Arm, Thrust Washers, Cover Plate and Rear Support Plate, Lockwashers and Nuts: Stainless steel

Detent Balls: Steel, nickel-plated

Detent Springs: Tinned music wire

Terminals, Stator (Base) Contacts and Common Plate: Brass, gold plate .00001" minimum over silver plate .0003" minimum

Rotor Contact: Silver alloy, gold-plated .00001" minimum

Mounting Hardware: Two mounting nuts .062" (1,57) thick by .312" (7,92) across flats and one internal tooth lockwasher are supplied with this switch.

Mounting Nuts, Washers: Brass, tin/zinc-plated and or stainless steel.

Mounting Nuts, Washers: Brass, tin/zinc-plated and or stainless steel.

ADDITIONAL CHARACTERISTICS

Standard Style and Military Qualified

Contacts: Shorting or Non-shorting contacts available in 30°, 36° and 45° angle of throw rotary switches. Non-shorting contacts available in 60° and 90° angle of throw switches. All are wiping contacts with over 100 grams of contact force.

Stop Strength: 12 lb-inches minimum

Rotational Torque: 8-64 oz-in depending upon the number of poles per deck and the number of decks

Extended Studs: Switches of six decks or more have longer studs with extra stud nuts for recommended double end mounting.

CHOICES AND LIMITATIONS

Series	Style and Designation	Angle of Throw	Stops	Terminals	Number of Decks		Poles Per Deck	Number of Positions/Pole			
					Shorting	Non-Shorting					
08	A = Standard S = Standard, Shaft/Panel Seal M = Military Style MS = Style M, Shaft/Panel Seal	36°	Fixed	Solder	01 thru 12 01 thru 09	01 thru 12 01 thru 09	1 2	02 thru 10 02 thru 05			
	Printed Circuit			01 thru 12 01 thru 09	01 thru 12 01 thru 09	1 2	02 thru 10 02 thru 05				
09	A = Standard S = Standard, Shaft/Panel Seal M = Military Style MS = Style M, Shaft/Panel Seal	30°	Fixed	Solder	01 thru 12 01 thru 09 01 thru 06 01 thru 04 01 thru 03 01 thru 03	01 thru 12 01 thru 09 01 thru 06 01 thru 04 01 thru 03 01 thru 03	1 2 3 4 5 6	02 thru 12 02 thru 06 02 thru 04 02 or 03 02 02			
	P = Standard, PC Mount SP = Style P, Shaft/Panel Seal MP = Military Style, PC Mount MSP = Style MP, Shaft/Panel Seal				45°	Printed Circuit	01 thru 12 01 thru 09	01 thru 12 01 thru 09	1 2	02 thru 12 02 thru 06	
	A = Standard, S = Standard, Shaft/Panel Seal M = Military Style MS = Style M, Shaft/Panel Seal	60°					Solder	01 thru 12 01 thru 06 01 thru 04 01 thru 03	01 thru 12 01 thru 06 01 thru 04 01 thru 03	1 2 3 4	02 thru 08 02 thru 04 02 02
	A = Standard, S = Standard, Shaft/Panel Seal M = Military Style MS = Style M, Shaft/Panel Seal				Printed Circuit	Not Available		01 thru 06 01 thru 03 01 or 02	1 2 3	02 thru 006 02 or 03 02	
	P = Standard, PC Mount SP = Style P, Shaft/Panel Seal MP = Military Style, PC Mount MSP = Style MP, Shaft/Panel Seal					90°	Solder	Not Available	01 thru 06 01 thru 03	1 2	02 thru 06 02 or 03
	A = Standard S = Standard, Shaft/Panel Seal							Printed Circuit	Not Available	01 thru 06 01 thru 03	1 2
	P = Standard, PC Mount SP = Style, Shaft/Panel Seal					Not Available	01 thru 06 01 thru 03		1 2	02 thru 04 02	

Rotary Switches

ORDERING INFORMATION

09A30-03-1-12N-F

Series: determined by the angle of throw

Style*: Letter(s) from the Choices and Limitations chart

Angle of Throw: Must agree with Series Number

Stop Arrangement: Add letter C or F to a one pole per deck switch with the maximum number of positions for a stop between position 1 and the last position.

Type of Contacts: N = Non-shorting; S = Shorting

Positions Per Pole: Requires 02 positions as a minimum to the maximum allowable dependent on the angle of throw and poles per deck

Poles Per Deck: As limited by angle of throw and switch style

Number of Decks: As limited by the angle of throw, the poles per deck, switch style and types of contacts

** All rotary switches that are required to have military designated markings and testing adhering to MIL-3786 are to be ordered by specifying the military part number identified on the appropriate slash sheet.*

Данный компонент на территории Российской Федерации

Вы можете приобрести в компании MosChip.

Для оперативного оформления запроса Вам необходимо перейти по данной ссылке:

<http://moschip.ru/get-element>

Вы можете разместить у нас заказ для любого Вашего проекта, будь то серийное производство или разработка единичного прибора.

В нашем ассортименте представлены ведущие мировые производители активных и пассивных электронных компонентов.

Нашей специализацией является поставка электронной компонентной базы двойного назначения, продукции таких производителей как XILINX, Intel (ex.ALTERA), Vicor, Microchip, Texas Instruments, Analog Devices, Mini-Circuits, Amphenol, Glenair.

Сотрудничество с глобальными дистрибьюторами электронных компонентов, предоставляет возможность заказывать и получать с международных складов практически любой перечень компонентов в оптимальные для Вас сроки.

На всех этапах разработки и производства наши партнеры могут получить квалифицированную поддержку опытных инженеров.

Система менеджмента качества компании отвечает требованиям в соответствии с ГОСТ Р ИСО 9001, ГОСТ РВ 0015-002 и ЭС РД 009

Офис по работе с юридическими лицами:

105318, г.Москва, ул.Щербаковская д.3, офис 1107, 1118, ДЦ «Щербаковский»

Телефон: +7 495 668-12-70 (многоканальный)

Факс: +7 495 668-12-70 (доб.304)

E-mail: info@moschip.ru

Skype отдела продаж:

moschip.ru

moschip.ru_4

moschip.ru_6

moschip.ru_9