

## Data Sheet



### Description

The HCPL-7510 isolated linear current sensing IC family is designed for current sensing in low-power electronic motor drives. In a typical implementation, motor current flows through an external resistor and the resulting analog voltage drop is sensed by the HCPL-7510. An output voltage is created on the other side of the HCPL-7510 optical isolation barrier. This single-ended output voltage is proportional to the motor current. Since common-mode voltage swings of several hundred volts in tens of nanoseconds are common in modern switching inverter motor drives, the HCPL-7510 was designed to ignore very high common-mode transient slew rates (of at least 10 kV/μs).

The high CMR capability of the HCPL-7510 isolation amplifier provides the precision and stability needed to accurately monitor motor current in high noise motor control environments, providing for smoother control (less “torque ripple”) in various types of motor control applications.

The product can also be used for general analog signal isolation applications. For general applications, we recommend the HCPL-7510 (gain tolerance of ±3%). The HCPL-7510 utilizes sigma-delta (Σ-Δ) analog-to-digital converter technology to delivery offset and gain accuracy and stability over time and temperature. This performance is delivered in a compact, auto-insert, 8-pin DIP package that meets worldwide regulatory safety standards. (A gull-wing surface mount option 300 is also available).

### Features

- 15 kV/μs common-mode rejection at  $V_{cm} = 1000\text{ V}$
- Compact, auto-insertable 8-pin DIP package
- 60 ppm/°C gain drift vs. temperature
- -0.6 mV input offset voltage
- 8 μV/°C input offset voltage vs. temperature
- 100 kHz bandwidth
- 0.06% nonlinearity, single-ended amplifier output for low power application.
- Worldwide safety approval:  
UL 1577 (3750 Vrms/1 min.),  
CSA and IEC/EN/DIN EN 60747-5-2  
(Option 060 only)
- Advanced sigma-delta (Σ-Δ) A/D converter technology

### Applications

- Low-power inverter current sensing
- Motor phase and rail current sensing
- Switched mode power supply signal isolation
- General purpose low-power current sensing and monitoring
- General purpose analog signal isolation

### Functional Diagram

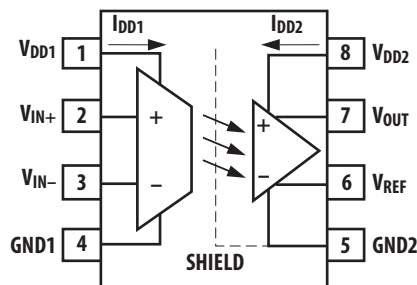

NOTE: A 0.1 μF bypass capacitor must be connected between pins 1 and 4 and between pins 5 and 8.

**CAUTION:** It is advised that normal static precautions be taken in handling and assembly of this component to prevent damage and /or degradation which may be induced by ESD.

## Ordering Information

HCPL-7510 is UL Recognized with 3750 Vrms for 1 minute per UL1577.

Part number	Option		Package	Surface Mount	Gull Wing	Tape & Reel	IEC/EN/DIN EN 60747-5-2	Quantity
	RoHS Compliant	Non-RoHS Compliant						
HCPL-7510	-000E	No option	300 mil DIP-8					50 per tube
	-300E	-300		X	X			50 per tube
	-500E	-500		X	X	X		1000 per reel
	-060E	-060					X	50 per tube
	-360E	-360		X	X		X	50 per tube
	-560E	-560		X	X	X	X	1000 per reel

To order, choose a part number from the part number column and combine with the desired option from the option column to form an order entry.

Example 1:

HCPL-7510-560E to order product of Gull Wing Surface Mount package in Tape and Reel packaging with IEC/EN/DIN EN 60747-5-2 Safety Approval in RoHS compliant.

Example 2:

HCPL-7510 to order product of 300 mil DIP package in tube packaging and non-RoHS compliant.

Option datasheets are available. Contact your Avago sales representative or authorized distributor for information.

## Package Outline Drawings

### HCPL-7510 Standard DIP Package

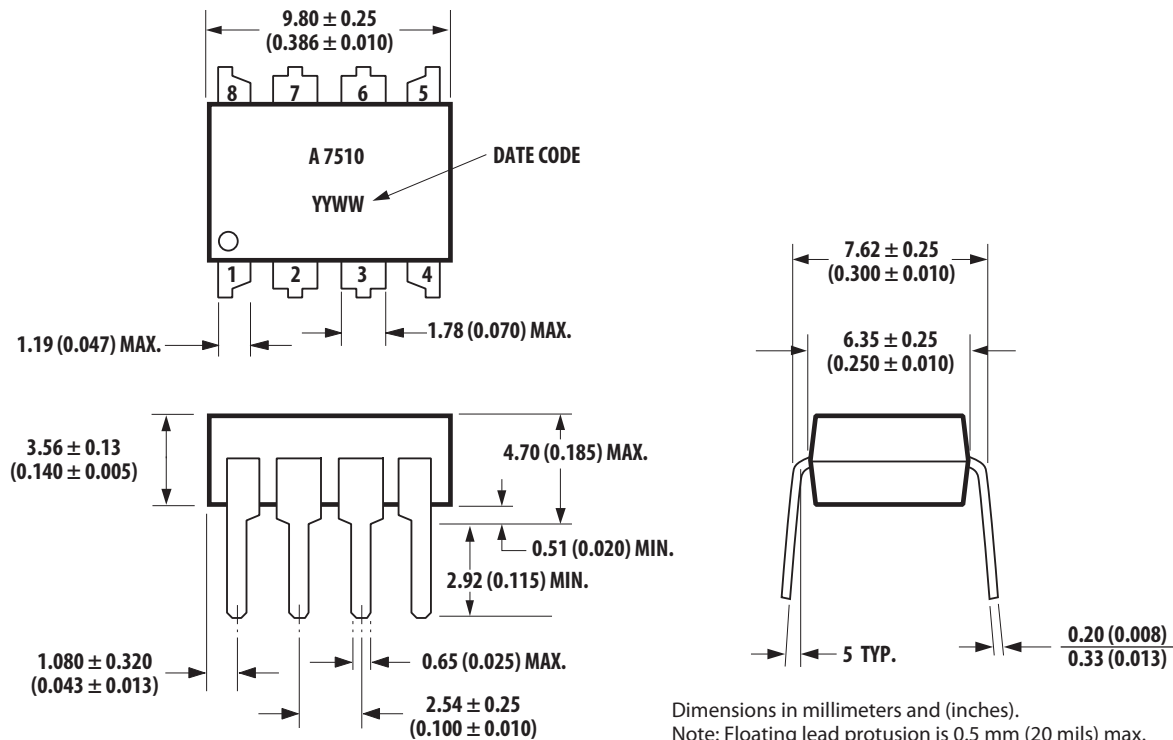

# HCPL-7510 Gull Wing Surface Mount Option 300 Outline Drawing

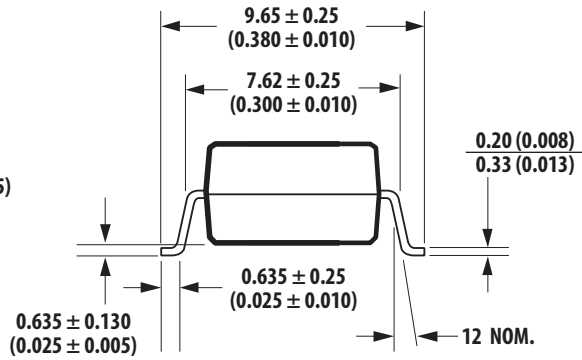
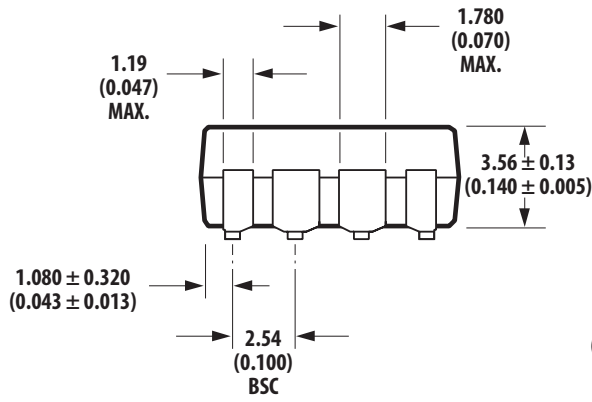
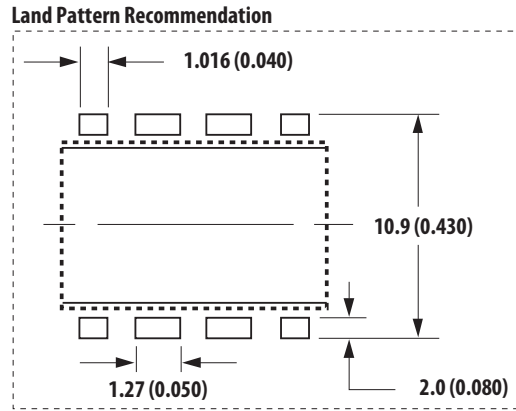
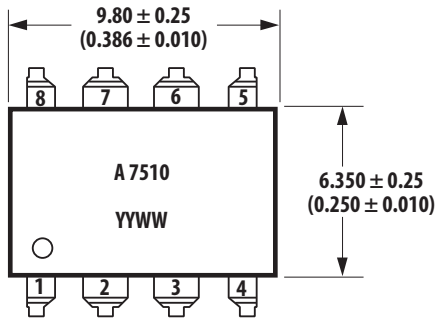

Dimensions in millimeters (inches).  
 Tolerances (unless otherwise specified): XX.XX = 0.01  
 XX.XXX = 0.005

**LEAD COPLANARITY  
 MAXIMUM: 0.102 (0.004)**

Note: Floating lead protusion is 0.5 mm (20 mils) max.

## Solder Reflow Temperature Profile

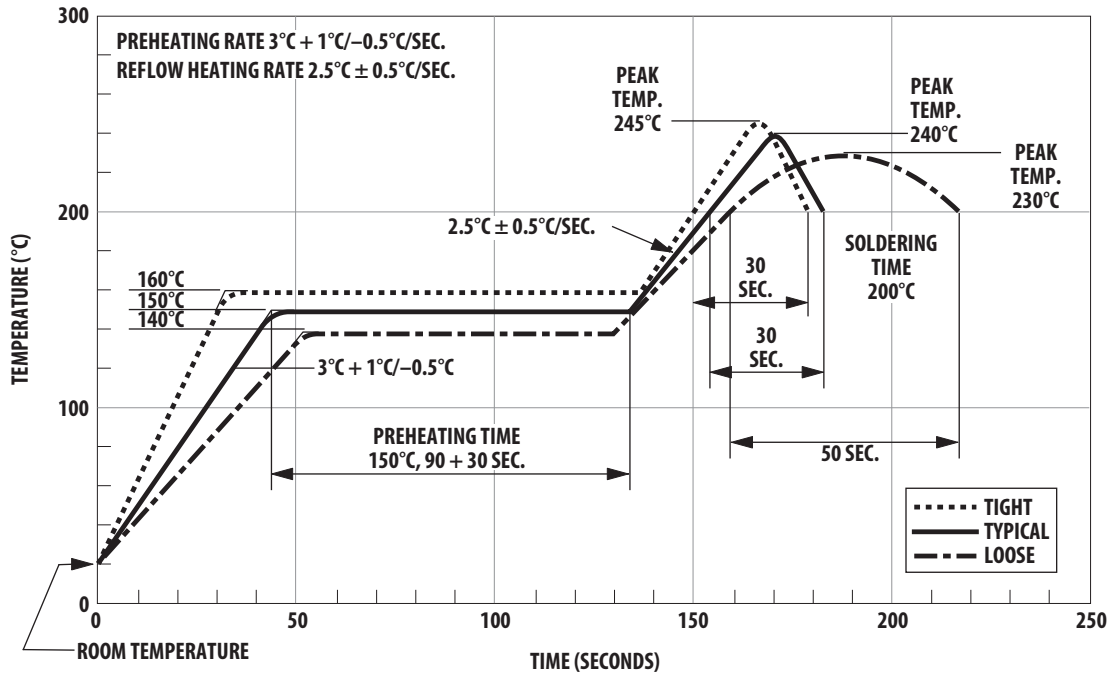

Note: Use of non-chlorine-activated fluxes is highly recommended.

## Recommended Pb-Free IR Profile

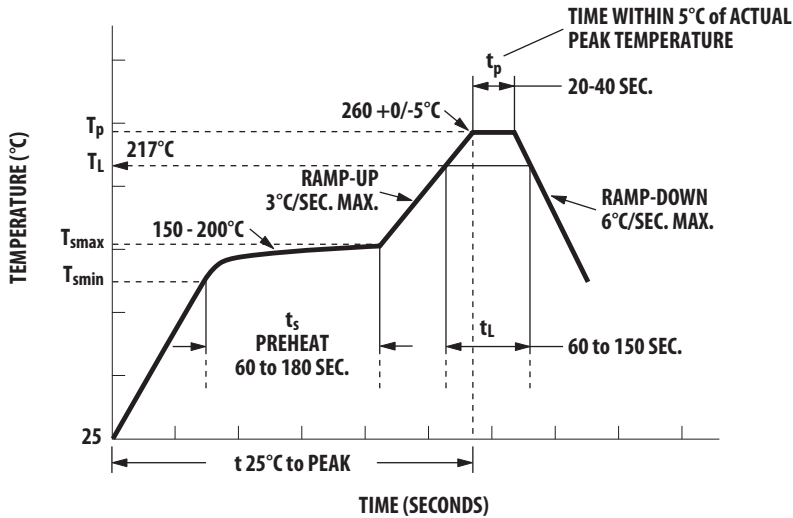

Notes:  
 the time from 25°C to peak temperature = 8 minutes max.  
 $T_{smax} = 200^{\circ}\text{C}$ ,  $t_{smin} = 150^{\circ}\text{C}$

Note: Use of non-chlorine-activated fluxes is highly recommended.

## Regulatory Information

The HCPL-7510 has been approved by the following organizations:

### IEC/EN/DIN EN 60747-5-2

Approved under:  
IEC 60747-5-2:1997 + A1:2002  
EN 60747-5-2:2001 + A1:2002  
DIN EN 60747-5-2 (VDE 0884 Teil 2):2003-01.

### UL

Approved under UL 1577, component recognition program up to  $V_{ISO} = 3750 V_{RMS}$ . File E55361.

### CSA

Approved under CSA Component Acceptance Notice #5, File CA 88324.

## IEC/EN/DIN EN 60747-5-2 Insulation Characteristics<sup>[1]</sup>

Description	Symbol	Characteristic	Unit
Installation classification per DIN EN 0110-1/1997-04, Table 1 for rated mains voltage $\leq 150 V_{RMS}$ for rated mains voltage $\leq 300 V_{RMS}$ for rated mains voltage $\leq 600 V_{RMS}$		I – IV I – III I – II	
Climatic Classification		55/100/21	
Pollution Degree (DIN EN 0110-1/1997-04)		2	
Maximum Working Insulation Voltage	$V_{IORM}$	891	$V_{peak}$
Input to Output Test Voltage, Method b <sup>[2]</sup> $V_{IORM} \times 1.875 = V_{PR}$ , 100% production test with $t_m = 1$ sec, partial discharge $< 5$ pC	$V_{PR}$	1670	$V_{peak}$
Input to Output Test Voltage, Method a <sup>[2]</sup> $V_{IORM} \times 1.5 = V_{PR}$ , type and sample test, $t_m = 60$ sec, partial discharge $< 5$ pC	$V_{PR}$	1336	$V_{peak}$
Highest Allowable Overvoltage (transient overvoltage $t_{ini} = 10$ sec)	$V_{IOTM}$	6000	$V_{peak}$
Safety-limiting values – maximum values allowed in the event of a failure.			
Case Temperature	$T_S$	175	$^{\circ}C$
Input Current <sup>[3]</sup>	$I_S, INPUT$	400	mA
Output Power <sup>[3]</sup>	$P_S, OUTPUT$	600	mW
Insulation Resistance at $T_S, V_{IO} = 500$ V	$R_S$	$> 10^9$	$\Omega$

Notes:

- Insulation characteristics are guaranteed only within the safety maximum ratings which must be ensured by protective circuits within the application. Surface Mount Classifications is Class A in accordance with CECC00802.
- Refer to the optocoupler section of the Isolation and Control Components Designer's Catalog, under Product Safety Regulations section, (IEC/EN/DIN EN 60747-5-2) for a detailed description of Method a and Method b partial discharge test profiles.
- Refer to the following figure for dependence of  $P_S$  and  $I_S$  on ambient temperature.

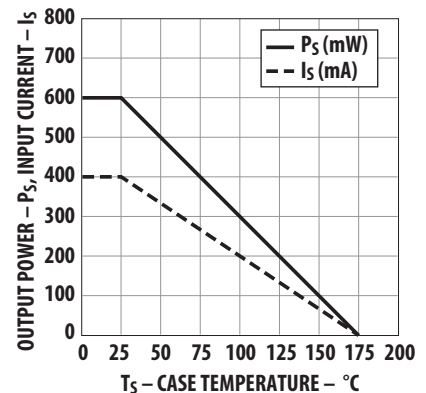

## Insulation and Safety Related Specifications

Parameter	Symbol	Value	Unit	Conditions
Minimum External Air Gap (clearance)	L(101)	7.4	mm	Measured from input terminals to output terminals, shortest distance through air.
Minimum External Tracking (creepage)	L(102)	8.0	mm	Measured from input terminals to output terminals, shortest distance path along body.
Minimum Internal Plastic Gap (internal clearance)		0.5	mm	Through insulation distance conductor to conductor, usually the straight line distance thickness between the emitter and detector.
Tracking Resistance (comparative tracking index)	CTI	>175	V	DIN IEC 112 Part 1
Isolation Group		IIIa		Material Group (DIN EN 0110-1/1997-04)

Option 300 - surface mount classification is Class A in accordance with CECC 00802.

## Absolute Maximum Ratings

Parameter	Symbol	Min.	Max.	Units	Note
Storage Temperature	$T_S$	-55	125	°C	
Operating Temperature	$T_A$	-40	100	°C	
Supply Voltage	$V_{DD1}, V_{DD2}$	0	6	V	
Steady-State Input Voltage	$V_{IN+}, V_{IN-}$	-2.0	$V_{DD1} + 0.5$	V	
Two Second Transient Input Voltage	$V_{IN+}, V_{IN-}$	-6.0	$V_{DD1} + 0.5$	V	
Output Voltage	$V_{OUT}$	-0.5	$V_{DD2} + 0.5$	V	
Reference Input Voltage	$V_{REF}$	0.0	$V_{DD2} + 0.5$	V	
Reference Input Current	$I_{REF}$		20	mA	
Lead Solder Temperature		260°C for 10 sec., 1.6 mm below seating plane			
Solder Reflow Temperature Profile		See Package Outline Drawings section			

## Recommended Operating Conditions

Parameter	Symbol	Min.	Max.	Units	Note
Operating Temperature	$T_A$	-40	85	°C	
Supply Voltage	$V_{DD1}, V_{DD2}$	4.5	5.5	V	
Input Voltage (accurate and linear)	$V_{IN+}, V_{IN-}$	-200	200	mV	
Input Voltage (functional)	$V_{IN+}, V_{IN-}$	-2.0	2.0	V	
Reference Input Voltage	$V_{REF}$	4.0	$V_{DD2}$	V	

## Electrical Specifications (DC)

Unless otherwise noted, all typicals and figures are at the nominal operation conditions of  $V_{IN+} = 0V$ ,  $V_{IN-} = 0V$ ,  $V_{REF} = 4.0V$ ,  $V_{DD1} = V_{DD2} = 5.0V$  and  $T_A = 25^\circ C$ ; all Minimum/Maximum specifications are within the Recommended Operating Conditions.

Parameter	Symbol	Min.	Typ.	Max.	Units	Test Conditions	Fig.	Note
Input Offset Voltage	$V_{OS}$	-6	-0.6	6	mV	$V_{IN+} = 0V$	6	1
Magnitude of Input Offset Change vs. Temperature	$\Delta V_{OS}/\Delta T$		8	20	$\mu V/^\circ C$	$V_{IN+} = 0V$	7	
Gain	G	$V_{REF}/0.512$ - 3%	$V_{REF}/0.512$	$V_{REF}/0.512$ + 3%	V/V	$-0.2V < V_{IN+} < 0.2V$ $T_A = 25^\circ C$	8, 9	2
Magnitude of Gain Change vs. Temperature	$\Delta G/\Delta T$		60	300	ppm/ $^\circ C$	$-0.2V < V_{IN+} < 0.2V$	9	
$V_{OUT}$ 200 mV Nonlinearity	NL <sub>200</sub>		0.06	0.55	%	$-0.2V < V_{IN+} < 0.2V$	10, 11	3,4
Magnitude of $V_{OUT}$ 200 mV Nonlinearity Change vs. Temperature	$ dNL_{200}/dT $		0.0004		%/ $^\circ C$	$-0.2V < V_{IN+} < 0.2V$	11	
$V_{OUT}$ 100 mV Nonlinearity	NL <sub>100</sub>		0.04	0.4	%	$-0.1V < V_{IN+} < 0.1V$	10, 11	3,5
Input Supply Current	$I_{DD1}$		11.7	16	mA		1,2,3	
Output Supply Current	$I_{DD2}$		9.9	16	mA		1,2,3	
Reference Voltage Input Current	$I_{REF}$		0.26	1	mA			
Input Current	$I_{IN+}$		-0.6	5	$\mu A$	$V_{IN+} = 0V$	4	
Magnitude of Input Bias Current vs. Temperature Coefficient	$ dI_{IN+}/dT $		0.45		nA/ $^\circ C$			
Maximum Input Voltage before $V_{OUT}$ Clipping	$ V_{IN+} _{MAX}$		256		mV		5	
Equivalent Input Impedance	$R_{IN}$		700		k $\Omega$			
$V_{OUT}$ Output Impedance	$R_{OUT}$		15		$\Omega$			
Input DC Common-Mode Rejection Ratio	$CMRR_{IN}$		63		dB			7

## Switching Specifications (AC)

Over recommended operating conditions unless otherwise specified.

Parameter	Symbol	Min.	Typ.	Max.	Units	Test Conditions	Fig. Note
V <sub>IN</sub> to V <sub>OUT</sub> Signal Delay (50 – 10%)	t <sub>PD10</sub>		2.2	4	μs	V <sub>IN+</sub> = 0 mV to 200 mV step	13
V <sub>IN</sub> to V <sub>OUT</sub> Signal Delay (50 – 50%)	t <sub>PD50</sub>		3.4	5	μs		
V <sub>IN</sub> to V <sub>OUT</sub> Signal Delay (50 – 90%)	t <sub>PD90</sub>		5.2	9.9	μs		
V <sub>OUT</sub> Rise Time (10 – 90%)	t <sub>R</sub>		3.0	7	μs		
V <sub>OUT</sub> Fall Time (10 – 90%)	t <sub>F</sub>		3.2	7	μs		
V <sub>OUT</sub> Bandwidth (-3 dB)	BW	50	100		kHz	V <sub>IN+</sub> = 200 mV <sub>pk-pk</sub>	14
V <sub>OUT</sub> Noise	N <sub>OUT</sub>		31.5		mV <sub>rms</sub>	V <sub>IN+</sub> = 0 V	
Common Mode Transient Immunity	CMTI	10	15		kV/μs	T <sub>A</sub> = 25°C, V <sub>CM</sub> = 1000 V	15

## Package Characteristics

Parameter	Symbol	Min.	Typ.	Max.	Units	Test Conditions	Fig. Note
Input-Output Momentary Withstand Voltage	V <sub>ISO</sub>	3750			V <sub>rms</sub>	T <sub>A</sub> = 25°C, RH < 50%	6
Input-Output Resistance	R <sub>I-O</sub>		>10 <sup>9</sup>		Ω	V <sub>I-O</sub> = 500 V	
Input-Output Capacitance	C <sub>I-O</sub>		1.4		pF	Freq = 1 MHz	

### Notes:

General Note: Typical values were taken from a sample of nominal units operating at nominal conditions (V<sub>DD1</sub> = V<sub>DD2</sub> = 5 V, V<sub>REF</sub> = 4.0 V, Temperature = 25°C) unless otherwise stated. Nominal plots shown from Figure 1 to 11 represented the drift of these nominal units from their nominal operating conditions.

1. Input Offset Voltage is defined as the DC Input Voltage required to obtain an output voltage of V<sub>REF</sub>/2.
2. Gain is defined as the slope of the best-fit line of the output voltage vs. the differential input voltage (V<sub>IN+</sub> - V<sub>IN-</sub>) over the specified input range. Gain is derived from V<sub>REF</sub>/512 mV; e.g. V<sub>REF</sub> = 5.0, gain will be 9.77 V/V.
3. Nonlinearity is defined as half of the peak-to-peak output deviation from the best-fit gain line, expressed as a percentage of the full-scale output voltage range.
4. NL<sub>200</sub> is the nonlinearity specified over an input voltage range of ±200 mV.
5. NL<sub>100</sub> is the nonlinearity specified over an input voltage range of ±100 mV.
6. In accordance with UL1577, each optocoupler is proof tested by applying an insulation test voltage ≥ 4500 V<sub>rms</sub> for 1 second (leakage detection current limit, I<sub>I-O</sub> ≤ 5 μA). This test is performed before the 100% production test for the partial discharge (method b) shown in IEC/EN/DIN EN 60747-5-2 Insulation Characteristic Table, if applicable.
7. CMRR is defined as the ratio of the differential signal gain (signal applied differentially between pins 2 and 3) to the common-mode gain (input pins tied together and the signal applied to both inputs at the same time), expressed in dB.



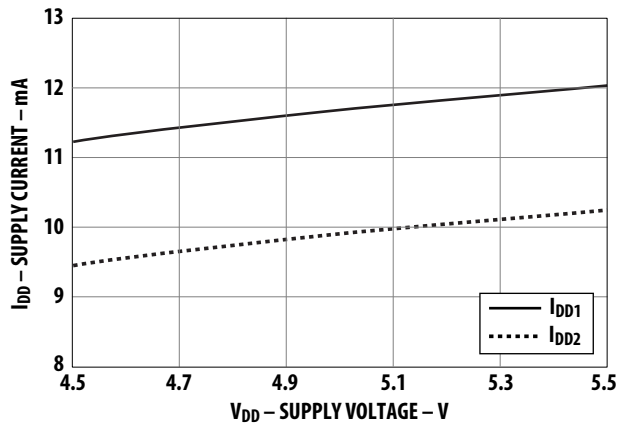

Figure 1. Supply current vs. supply voltage.

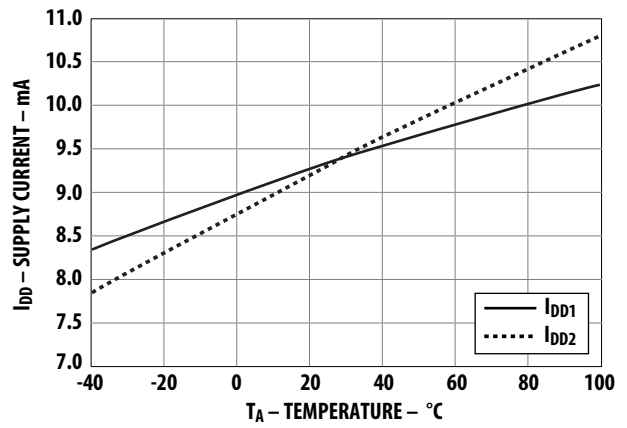

Figure 2. Supply current vs. temperature.

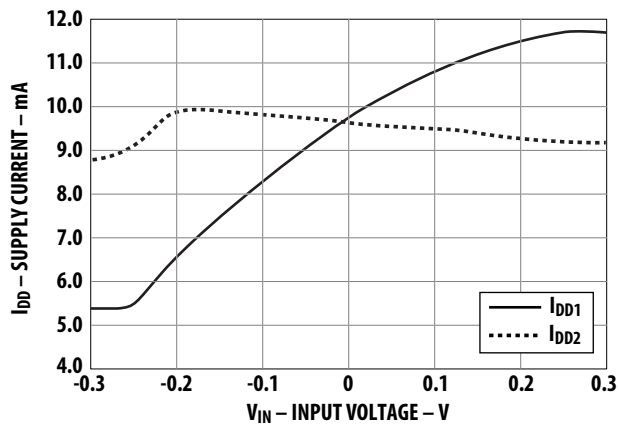

Figure 3. Supply current vs. input voltage.

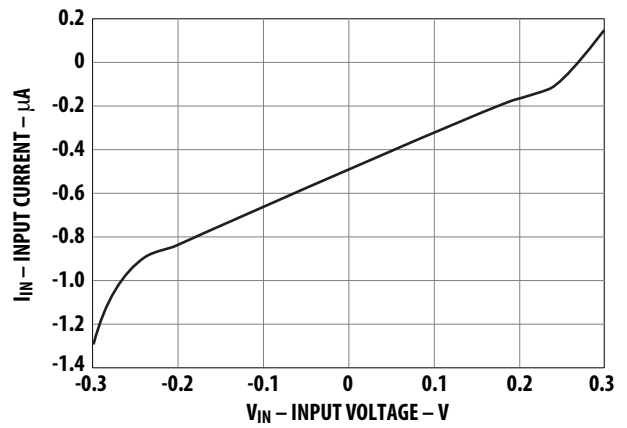

Figure 4. Input current vs. input voltage.

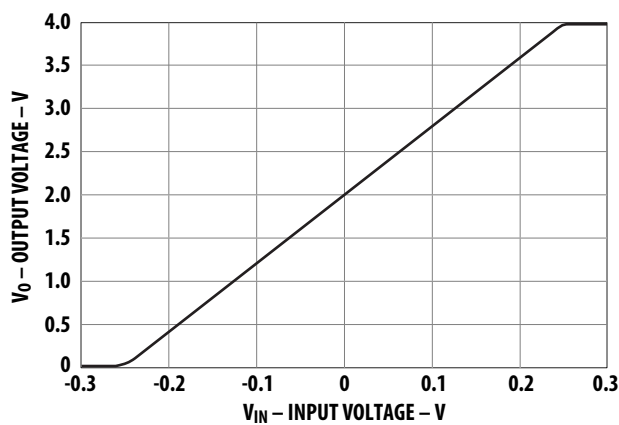

Figure 5. Output voltage vs. input voltage.

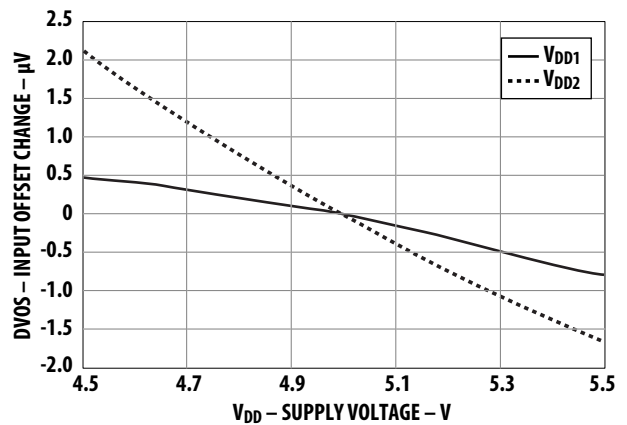

Figure 6. Input offset change vs. supply voltage.

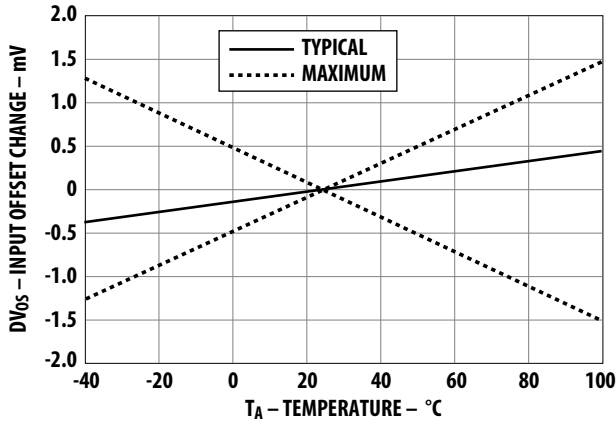

Figure 7. Input offset change vs. temperature.

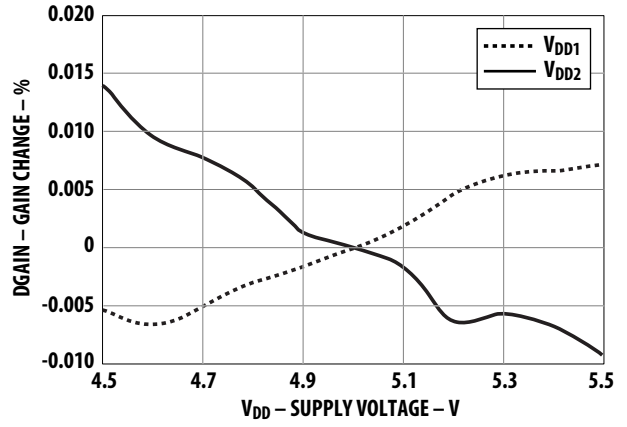

Figure 8. Gain change vs. supply voltage.

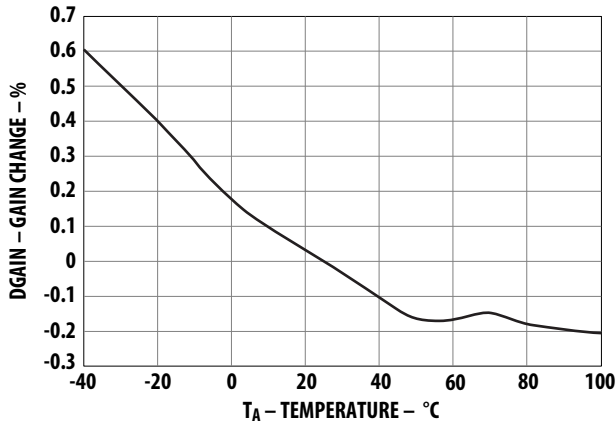

Figure 9. Gain change vs. temperature.

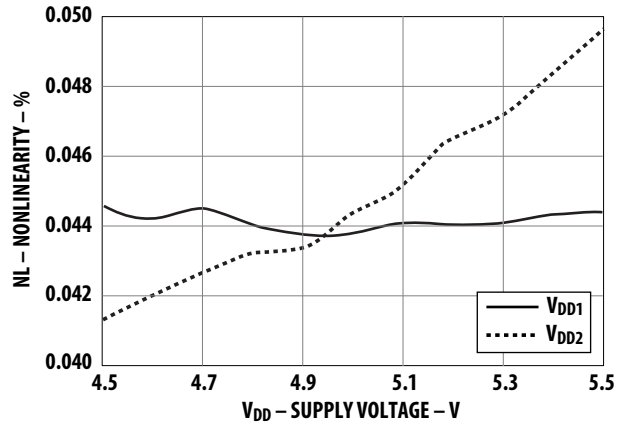

Figure 10. Nonlinearity vs. supply voltage.

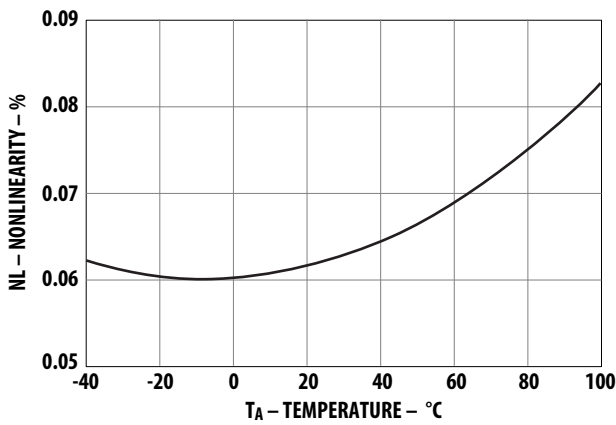

Figure 11. Nonlinearity vs. temperature.

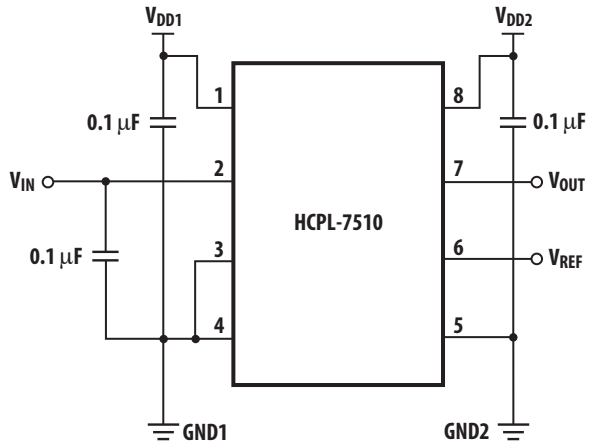

Figure 12. Propagation delay test circuit.

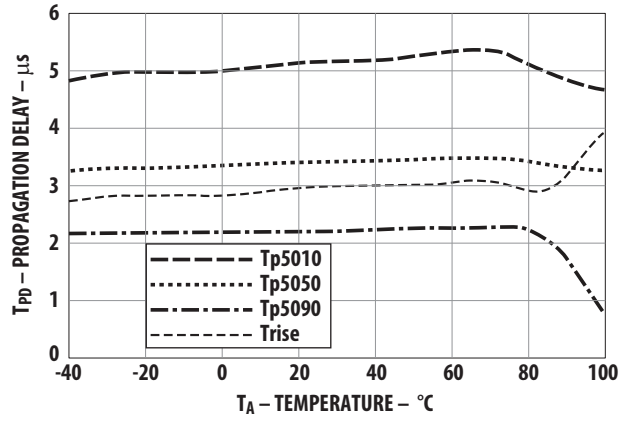

Figure 13. Propagation delay vs. temperature.

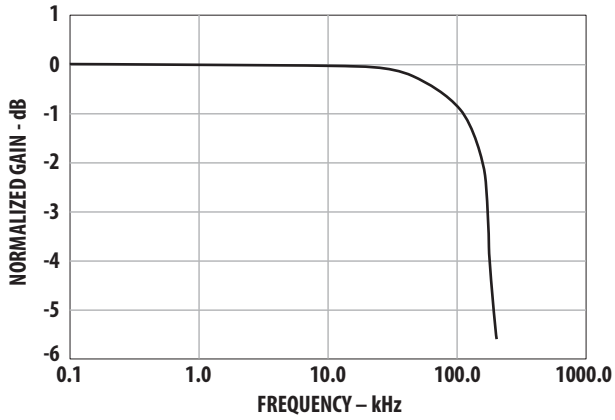

Figure 14. Bandwidth.

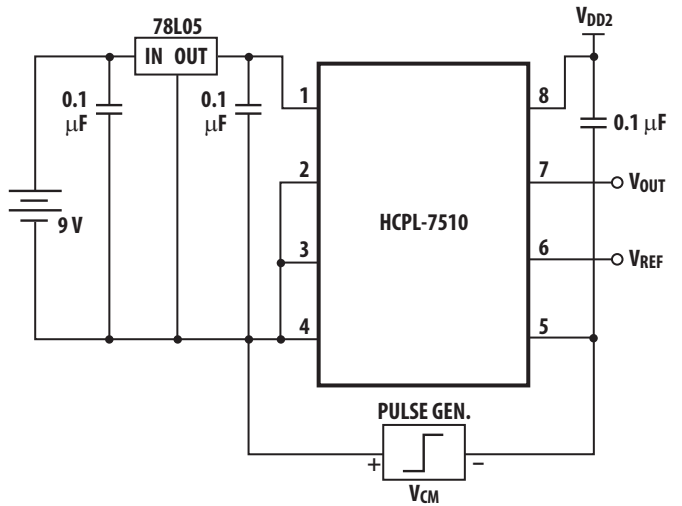

Figure 15. CMTI test circuit.

## Application Information

### Power Supplies and Bypassing

The recommended supply connections are shown in Figure 16. A floating power supply (which in many applications could be the same supply that is used to drive the high-side power transistor) is regulated to 5 V using a simple zener diode (D1); the value of resistor R4 should be chosen to supply sufficient current from the existing floating supply. The voltage from the current sensing resistor (R<sub>sense</sub>) is applied to the input of the HCPL-7510 through an RC anti-aliasing filter (R2 and C2). Although the application circuit is relatively simple, a few recommendations should be followed to ensure optimal performance.

The power supply for the HCPL-7510 is most often obtained from the same supply used to power the power transistor gate drive circuit. If a dedicated supply is required, in many cases it is possible to add an additional winding on an existing transformer. Otherwise, some sort of simple isolated supply can be used, such as a line powered transformer or a high-frequency DC-DC converter.

An inexpensive 78L05 three-terminal regulator can also be used to reduce the floating supply voltage to 5 V. To help attenuate high-frequency power supply noise or ripple, a resistor or inductor can be used in series with the input of the regulator to form a low-pass filter with the regulator's input bypass capacitor.

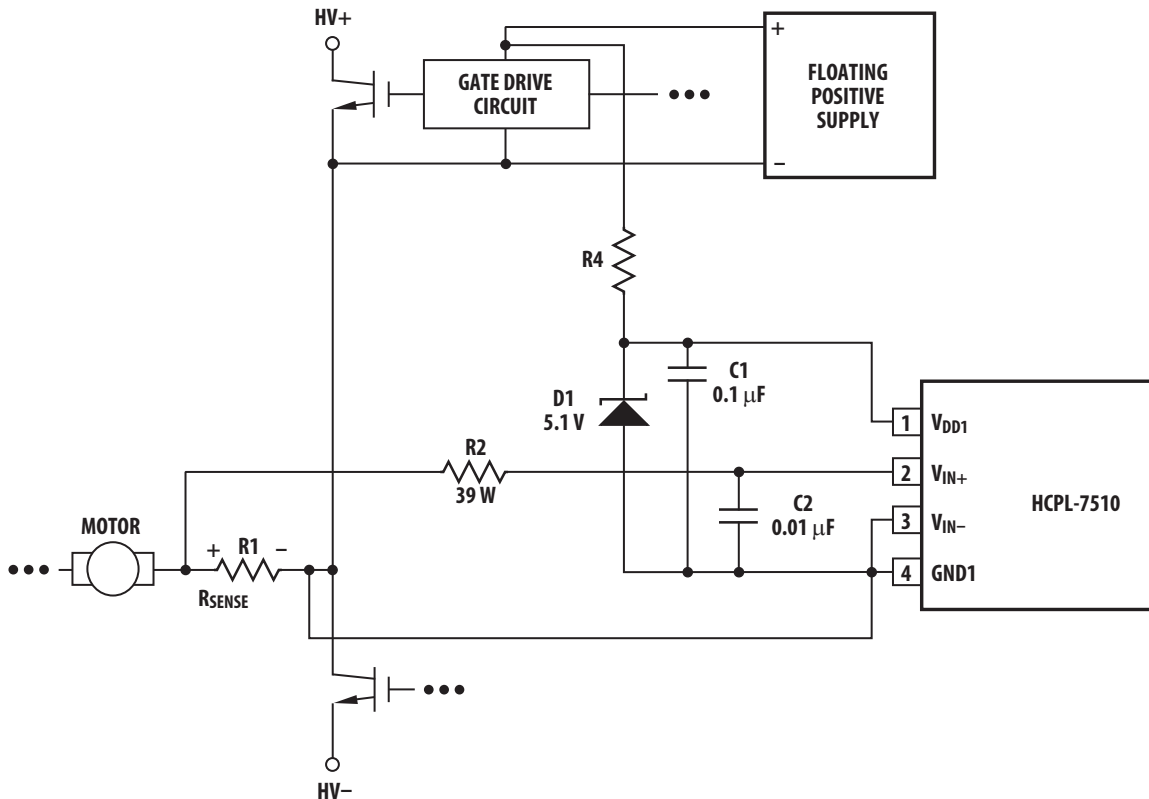

Figure 16. Recommended supply and sense resistor connections.

As shown in Figure 17, 0.1  $\mu\text{F}$  bypass capacitors (C1, C2) should be located as close as possible to the pins of the HCPL-7510. The bypass capacitors are required because of the high-speed digital nature of the signals inside the HCPL-7510. A 0.01  $\mu\text{F}$  bypass capacitor (C3) is also recommended at the input due to the switched-capacitor nature of the input circuit. The input bypass capacitor also forms part of the anti-aliasing filter, which is recommended to prevent high frequency noise from aliasing down to lower frequencies and interfering with the input signal. The input filter also performs an important reliability function—it reduces transient spikes from ESD events flowing through the current sensing resistor.

## PC Board Layout

The design of the printed circuit board (PCB) should follow good layout practices, such as keeping bypass capacitors close to the supply pins, keeping output signals away from input signals, the use of ground and power planes, etc. In addition, the layout of the PCB can also affect the isolation transient immunity (CMTI) of the HCPL-7510, due primarily to stray capacitive coupling between the input and the output circuits. To obtain optimal CMTI performance, the layout of the PC board should minimize any stray coupling by maintaining the maximum possible distance between the input and output sides of the circuit and ensuring that any ground or power plane on the PC board does not pass directly below or extend much wider than the body of the HCPL-7510.

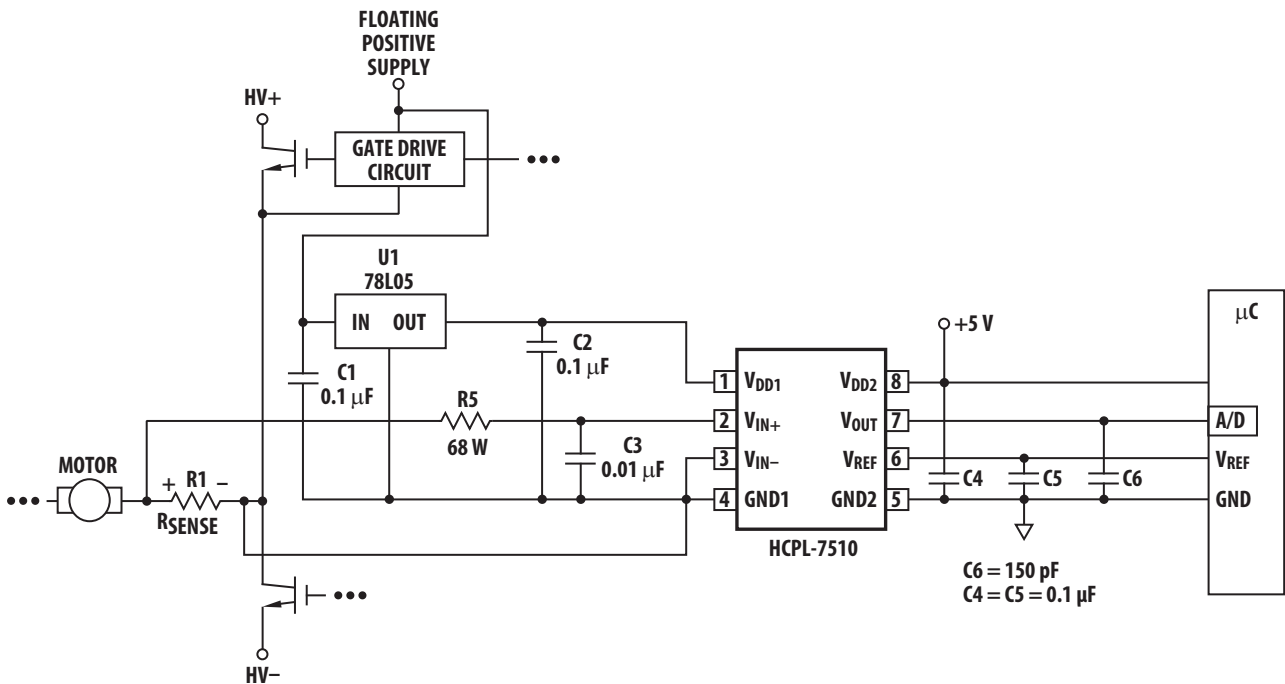

Figure 17. Recommended HCPL-7510 application circuit.

## Current Sensing Resistors

The current sensing resistor should have low resistance (to minimize power dissipation), low inductance (to minimize di/dt induced voltage spikes which could adversely affect operation), and reasonable tolerance (to maintain overall circuit accuracy). Choosing a particular value for the resistor is usually a compromise between minimizing power dissipation and maximizing accuracy. Smaller sense resistance decreases power dissipation, while larger sense resistance can improve circuit accuracy by utilizing the full input range of the HCPL-7510.

The first step in selecting a sense resistor is determining how much current the resistor will be sensing. The graph in Figure 18 shows the RMS current in each phase of a three-phase induction motor as a function of average motor output power (in horsepower, hp) and motor drive supply voltage. The maximum value of the sense resistor is determined by the current being measured and the maximum recommended input voltage of the isolation amplifier. The maximum sense resistance can be calculated by taking the maximum recommended input voltage and dividing by the peak current that the sense resistor should see during normal operation. For example, if a motor will have a maximum RMS current of 10 A and can experience up to 50% overloads during normal operation, then the peak current is 21.1 A ( $=10 \times 1.414 \times 1.5$ ). Assuming a maximum input voltage of 200 mV, the maximum value of sense resistance in this case would be about 10 m $\Omega$ . The maximum average power dissipation in the sense resistor can also be easily calculated by multiplying the sense resistance times the square of the maximum RMS current, which is about 1 W in the previous example. If the power dissipation in the sense resistor is too high, the resistance can be decreased below the maximum value to decrease power dissipation. The minimum value of the sense resistor is limited by precision and accuracy requirements of the design. As the resistance value is reduced, the output voltage across the resistor is also reduced, which means that the offset and noise, which are fixed, become a larger percentage of the signal amplitude. The selected value of the sense resistor will fall somewhere between the minimum and maximum values, depending on the particular requirements of a specific design.

When sensing currents large enough to cause significant heating of the sense resistor, the temperature coefficient (tempco) of the resistor can introduce nonlinearity due to the signal dependent temperature rise of the resistor. The effect increases as the resistor-to-ambient thermal resistance increases. This effect can be minimized by reducing the thermal resistance of the current sensing resistor or by using a resistor with a lower tempco. Lowering the thermal resistance can be accomplished by repositioning the current sensing resistor on the PC board, by using larger PC board traces to carry away more heat, or by using a heat sink. For a two-terminal current sensing resistor, as the value of resistance decreases, the resistance of the leads become a significant percentage of the total resistance. This has two primary effects on resistor accuracy. First, the effective resistance of the sense resistor can become dependent on factors such as how long the leads are, how they are bent, how far they are inserted into the board, and how far solder wicks up the leads during assembly (these issues will be discussed in more detail shortly). Second, the leads are typically made from a material, such as copper, which has a much higher tempco than the material from which the resistive element itself is made, resulting in a higher tempco overall. Both of these effects are eliminated when a four-terminal current sensing resistor is used. A four-terminal resistor has two additional terminals that are Kelvin-connected directly across the resistive element itself; these two terminals are used to monitor the voltage across the resistive element while the other two terminals are used to carry the load current. Because of the Kelvin connection, any voltage drops across the leads carrying the load current should have no impact on the measured voltage.

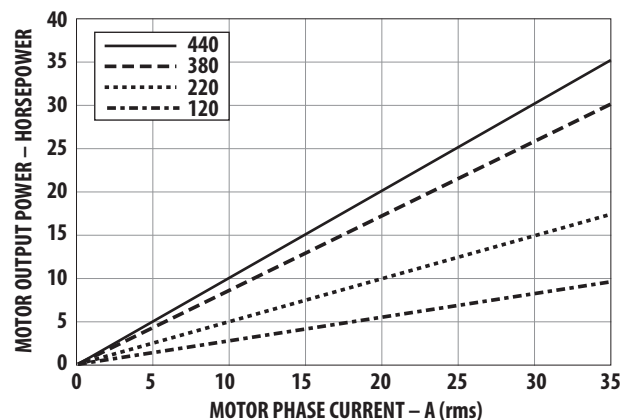

Figure 18. Motor output horsepower vs. motor phase current and supply voltage.

When laying out a PC board for the current sensing resistors, a couple of points should be kept in mind. The Kelvin connections to the resistor should be brought together under the body of the resistor and then run very close to each other to the input of the HCPL-7510; this minimizes the loop area of the connection and reduces the possibility of stray magnetic fields from interfering with the measured signal. If the sense resistor is not located on the same PC board as the HCPL-7510 circuit, a tightly twisted pair of wires can accomplish the same thing. Also, multiple layers of the PC board can be used to increase current carrying capacity. Numerous plated-through vias should surround each non-Kelvin terminal of the sense resistor to help distribute the current between the layers of the PC board. The PC board should use 2 or 4 oz. copper for the layers, resulting in a current carrying capacity in excess of 20 A. Making the current carrying traces on the PC board fairly large can also improve the sense resistor's power dissipation capability by acting as a heat sink. Liberal use of vias where the load current enters and exits the PC board is also recommended.

### **Sense Resistor Connections**

The recommended method for connecting the HCPL-7510 to the current sensing resistor is shown in Figure 17. VIN+ (pin 2 of the HCPL-7510) is connected to the positive terminal of the sense resistor, while VIN- (pin 3) is shorted to GND1 (pin 4), with the powersupply return path functioning as the sense line to the negative terminal of the current sense resistor. This allows a single pair of wires or PC board traces to connect the HCPL-7510 circuit to the sense resistor. By referencing the input circuit to the negative side of the sense resistor, any load current induced noise transients on the resistor are seen as a common-mode signal and will not interfere with the current-sense signal. This is important because the large load currents flowing through the motor drive, along with the parasitic inductances inherent in the wiring of the circuit, can generate both noise spikes and offsets that are relatively large compared to the small voltages that are being measured across the current sensing resistor. If the same power supply is used both for the gate drive circuit and for the current sensing circuit, it is very important that the connection from GND1 of the HCPL-7510 to the sense resistor be the only return path for supply current to the gate drive power supply in order to eliminate potential ground loop problems. The only direct connection between the HCPL-7510 circuit and the gate drive circuit should be the positive power supply line.

## FREQUENTLY ASKED QUESTIONS ABOUT THE HCPL-7510

### 1. THE BASICS

#### 1.1: Why should I use the HCPL-7510 for sensing current when Hall-effect sensors are available which don't need an isolated supply voltage?

Available in an auto-insertable, 8-pin DIP package, the HCPL-7510 is smaller than and has better linearity, offset vs. temperature and Common Mode Rejection (CMR) performance than most Hall-effect sensors. Additionally, often the required input-side power supply can be derived from the same supply that powers the gate-drive optocoupler.

### 2. SENSE RESISTOR AND INPUT FILTER

#### 2.1: Where do I get 10 mΩ resistors? I have never seen one that low.

Although less common than values above 10 Ω, there are quite a few manufacturers of resistors suitable for measuring currents up to 50 A when combined with the HCPL-7510. Example product information may be found at Dale's web site (<http://www.vishay.com/vishay/dale>) and Isotek's web site (<http://www.isotekcorp.com>) and Iwaki Musen Kenkyusho's website (<http://www.iwaki-musen.co.jp>) and Micron Electric's website (<http://www.micron-e.co.jp>).

#### 2.2: Should I connect both inputs across the sense resistor instead of grounding VIN- directly to pin 4?

This is not necessary, but it will work. If you do, be sure to use an RC filter on both pin 2 (VIN+) and pin 3 (VIN-) to limit the input voltage at both pads.

#### 2.3: Do I really need an RC filter on the input? What is it for? Are other values of R and C okay?

The input anti-aliasing filter (R=39 Ω, C=0.01 μF) shown in the typical application circuit is recommended for filtering fast switching voltage transients from the input signal. (This helps to attenuate higher signal frequencies which could otherwise alias with the input sampling rate and cause higher input offset voltage.)

Some issues to keep in mind using different filter resistors or capacitors are:

1. (Filter resistor:) The equivalent input resistance for HCPL-7510 is around 700 kΩ. It is therefore best to ensure that the filter resistance is not a significant percentage of this value; otherwise the offset voltage will be increased through the resistor divider effect. [As an example, if  $R_{\text{filt}} = 5.5 \text{ k}\Omega$ , then  $V_{\text{OS}} = (V_{\text{in}} * 1\%) = 2 \text{ mV}$  for a maximum 200 mV input and VOS will vary with respect to  $V_{\text{in}}$ .]

2. The input bandwidth is changed as a result of this different R-C filter configuration. In fact this is one of the main reasons for changing the input-filter R-C time constant.

3. (Filter capacitance:) The input capacitance of the HCPL-7510 is approximately 1.5 pF. For proper operation the switching input-side sampling capacitors must be charged from a relatively fixed (low impedance) voltage source. Therefore, if a filter capacitor is used it is best for this capacitor to be a few orders of magnitude greater than the  $C_{\text{INPUT}}$  (A value of at least 100 pF works well.)

#### 2.4: How do I ensure that the HCPL-7510 is not destroyed as a result of short circuit conditions which cause voltage drops across the sense resistor that exceed the ratings of the HCPL-7510's inputs?

Select the sense resistor so that it will have less than 5 V drop when short circuits occur. The only other requirement is to shut down the drive before the sense resistor is damaged or its solder joints melt. This ensures that the input of the HCPL-7510 can not be damaged by sense resistors going open-circuit.

### 3. ISOLATION AND INSULATION

#### 3.1: How many volts will the HCPL-7510 withstand?

The momentary (1 minute) withstand voltage is 3750 V rms per UL 1577 and CSA Component Acceptance Notice #5.

### 4. ACCURACY

#### 4.1: Does the gain change if the internal LED light output degrades with time?

No. The LED is used only to transmit a digital pattern. Avago Technologies has accounted for LED degradation in the design of the product to ensure long life.

### 5. MISCELLANEOUS

#### 5.1: How does the HCPL-7510 measure negative signals with only a +5 V supply?

The inputs have a series resistor for protection against large negative inputs. Normal signals are no more than 200 mV in amplitude. Such signals do not forward bias any junctions sufficiently to interfere with accurate operation of the switched capacitor input circuit.



For product information and a complete list of distributors, please go to our web site: [www.avagotech.com](http://www.avagotech.com)

Avago, Avago Technologies, and the A logo are trademarks of Avago Technologies in the United States and other countries.  
Data subject to change. Copyright © 2005-2009 Avago Technologies. All rights reserved. Obsoletes 5989-2162EN  
AV02-0951EN - April 15, 2009



## Данный компонент на территории Российской Федерации

### Вы можете приобрести в компании MosChip.

Для оперативного оформления запроса Вам необходимо перейти по данной ссылке:

<http://moschip.ru/get-element>

Вы можете разместить у нас заказ для любого Вашего проекта, будь то серийное производство или разработка единичного прибора.

В нашем ассортименте представлены ведущие мировые производители активных и пассивных электронных компонентов.

Нашей специализацией является поставка электронной компонентной базы двойного назначения, продукции таких производителей как XILINX, Intel (ex.ALTERA), Vicor, Microchip, Texas Instruments, Analog Devices, Mini-Circuits, Amphenol, Glenair.

Сотрудничество с глобальными дистрибьюторами электронных компонентов, предоставляет возможность заказывать и получать с международных складов практически любой перечень компонентов в оптимальные для Вас сроки.

На всех этапах разработки и производства наши партнеры могут получить квалифицированную поддержку опытных инженеров.

Система менеджмента качества компании отвечает требованиям в соответствии с ГОСТ Р ИСО 9001, ГОСТ РВ 0015-002 и ЭС РД 009

### Офис по работе с юридическими лицами:

105318, г.Москва, ул.Щербаковская д.3, офис 1107, 1118, ДЦ «Щербаковский»

Телефон: +7 495 668-12-70 (многоканальный)

Факс: +7 495 668-12-70 (доб.304)

E-mail: [info@moschip.ru](mailto:info@moschip.ru)

Skype отдела продаж:

moschip.ru

moschip.ru\_4

moschip.ru\_6

moschip.ru\_9