

0.5A to 2.0A High-side Power Distribution Switches**AP2822****General Description**

The AP2822 is an integrated high-side power switch that consists of N-Channel MOSFET, charge pump, over current & temperature and other related protection circuits. The switch's low $R_{DS(ON)}$, 85m Ω , is designed to meet USB voltage drop requirements. The IC includes soft-start to limit inrush current, over-current protection, load short protection with fold-back, and thermal shutdown to avoid switch failure during hot plug-in. Under voltage lockout (UVLO) function is used to ensure the device remain off unless there is a valid input voltage present. A FLAG output is available to indicate fault conditions to the local USB controller.

The AP2822 is available in the standard package of SOT-23-5.

Features

- Low MOSFET On Resistance: 85m Ω
- Compliant to USB Specifications
- Available 4 Versions of Continuous Load: 0.5A/1.0A/1.5A/2.0A
- Logic Level Enable Pin: Available with Active-high or Active-low Version
- Operating Voltage Range: 2.7V to 5.5V
- Low Supply Current: 68 μ A (Typ.)
- Low Shutdown Current: 1.0 μ A (Max)
- Under-voltage Lockout
- Soft Start-up
- Over-current Protection
- Over Temperature Protection
- Load Short Protection with Fold-back
- No Reverse Current When Power Off
- Deglitched FLAG Output with Open Drain
- With Output Shutdown Pull-low Resistor

Applications

- USB Power Management
- USB Bus/Self Powered Hubs
- Hot-plug Power Supplies
- Battery-charger Circuits
- Notebooks, Motherboard PCs

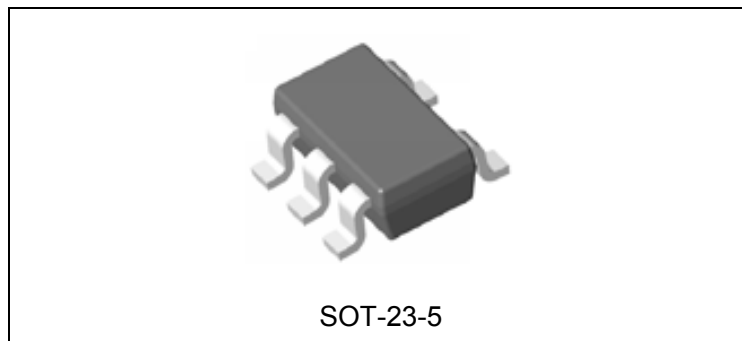

Figure 1. Package Type of AP2822

Pin Configuration

K/KA/KB/KE Package
(SOT-23-5)

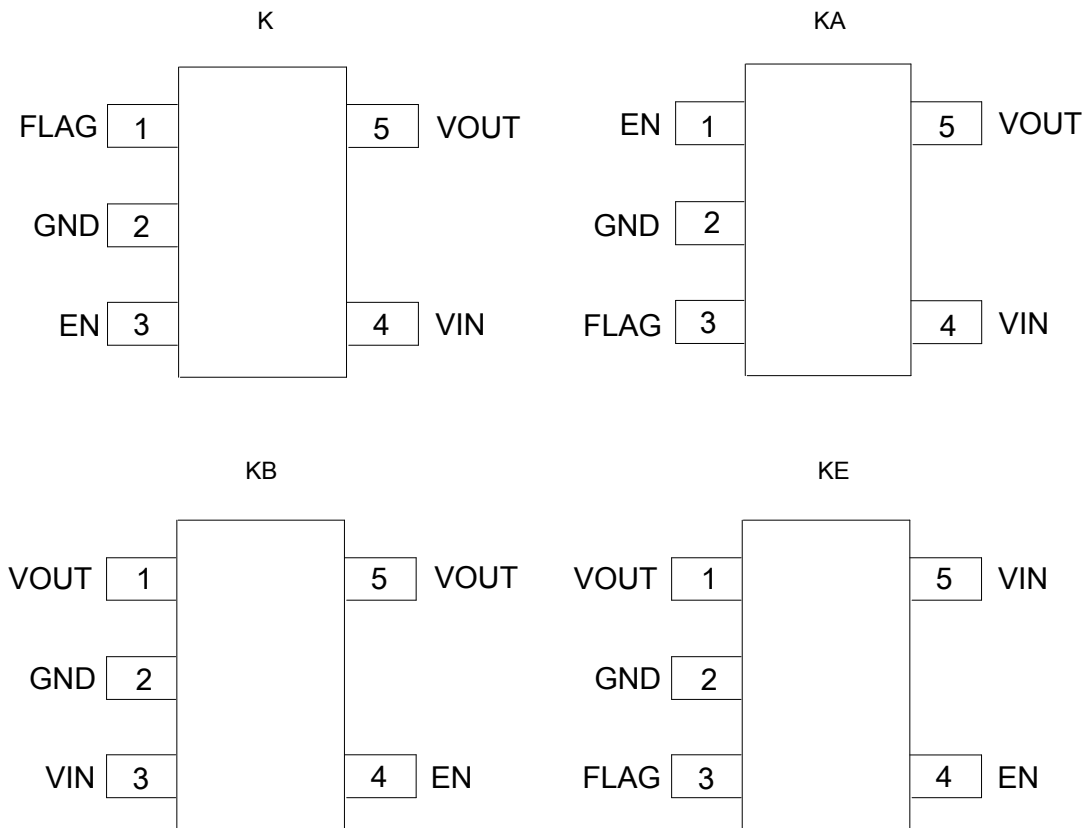

Figure 2. Pin Configuration of AP2822 (Top View)

**0.5A to 2.0A High-side Power Distribution Switches****AP2822****Pin Descriptions**

| Pin Number | Pin Name | Function |
|-------------------|-----------------|---|
| 1(K) | FLAG | Fault flag pin, output with open drain, need a pull-up resistor in application, active low to indicate OCP or OTP |
| 3(KA/KE) | | |
| 2 | GND | Ground |
| 3(K) | EN | Chip enable control input, active low or high |
| 1(KA) | | |
| 4(KB/KE) | | |
| 4(K/KA) | VIN | Supply input pin |
| 3(KB) | | |
| 5(KE) | | |
| 5(K/KA) | VOUT | Switch output voltage |
| 1,5(KB) | | |
| 1(KE) | | |

Functional Block Diagram



A(B){C}[D]

- A: SOT-23-5(K Package)
- B: SOT-23-5(KA Package)
- C: SOT-23-5(KB Package)
- D: SOT-23-5(KE Package)

Figure 3. Functional Block Diagram of AP2822



0.5A to 2.0A High-side Power Distribution Switches

AP2822

Ordering Information



| Package | Temperature Range | Condition | Part Number | Marking ID | Packing Type |
|----------|-------------------|-------------------------------|---------------|------------|--------------|
| SOT-23-5 | -40 to 85°C | Active High (Continuous 0.5A) | AP2822AKTR-G1 | GCQ | Tape & Reel |
| | | Active Low (Continuous 0.5A) | AP2822BKTR-G1 | GCR | Tape & Reel |
| | | Active High (Continuous 1.0A) | AP2822CKTR-G1 | GCS | Tape & Reel |
| | | Active Low (Continuous 1.0A) | AP2822DKTR-G1 | GCT | Tape & Reel |
| | | Active High (Continuous 1.5A) | AP2822EKTR-G1 | GCU | Tape & Reel |
| | | Active Low (Continuous 1.5A) | AP2822FKTR-G1 | GCV | Tape & Reel |
| | | Active High (Continuous 2.0A) | AP2822GKTR-G1 | GCW | Tape & Reel |
| | | Active Low (Continuous 2.0A) | AP2822HKTR-G1 | GCZ | Tape & Reel |

**0.5A to 2.0A High-side Power Distribution Switches****AP2822****Ordering Information (Continued)**

| Package | Temperature Range | Condition | Part Number | Marking ID | Packing Type |
|----------|-------------------|----------------------------------|----------------|------------|--------------|
| SOT-23-5 | -40 to 85°C | Active High (Continuous 0.5A) | AP2822AKATR-G1 | GDQ | Tape & Reel |
| | | Active Low (Continuous 0.5A) | AP2822BKATR-G1 | GDR | Tape & Reel |
| | | Active High (Continuous 1.0A) | AP2822CKATR-G1 | GDS | Tape & Reel |
| | | Active Low (Continuous 1.0A) | AP2822DKATR-G1 | GDT | Tape & Reel |
| | | Active High (Continuous 1.5A) | AP2822EKATR-G1 | GDU | Tape & Reel |
| | | Active Low (Continuous 1.5A) | AP2822FKATR-G1 | GDV | Tape & Reel |
| | | Active High (Continuous 2.0A) | AP2822GKATR-G1 | GDW | Tape & Reel |
| | | Active Low (Continuous 2.0A) | AP2822HKATR-G1 | GDZ | Tape & Reel |
| SOT-23-5 | -40 to 85°C | Active High (Continuous 0.5A) | AP2822AKBTR-G1 | GLA | Tape & Reel |
| | | Active Low (Continuous 0.5A) | AP2822BKBTR-G1 | GLB | Tape & Reel |
| | | Active High (Continuous 1.0A) | AP2822CKBTR-G1 | GLC | Tape & Reel |
| | | Active Low (Continuous 1.0A) | AP2822DKBTR-G1 | GLD | Tape & Reel |
| | | Active High (Continuous 1.5A) | AP2822EKBTR-G1 | GLE | Tape & Reel |
| | | Active Low (Continuous 1.5A) | AP2822FKBTR-G1 | GLF | Tape & Reel |
| | | Active High (Continuous 2.0A) | AP2822GKBTR-G1 | GLG | Tape & Reel |
| | | Active Low (Continuous 2.0A) | AP2822HKBTR-G1 | GLH | Tape & Reel |

**0.5A to 2.0A High-side Power Distribution Switches****AP2822****Ordering Information (Continued)**

| Package | Temperature Range | Condition | Part Number | Marking ID | Packing Type |
|----------|-------------------|----------------------------------|----------------|------------|--------------|
| SOT-23-5 | -40 to 85°C | Active High (Continuous 0.5A) | AP2822AKETR-G1 | GLI | Tape & Reel |
| | | Active Low (Continuous 0.5A) | AP2822BKETR-G1 | GLJ | Tape & Reel |
| | | Active High (Continuous 1.0A) | AP2822CKETR-G1 | GLK | Tape & Reel |
| | | Active Low (Continuous 1.0A) | AP2822DKETR-G1 | GLL | Tape & Reel |
| | | Active High (Continuous 1.5A) | AP2822EKETR-G1 | GLM | Tape & Reel |
| | | Active Low (Continuous 1.5A) | AP2822FKETR-G1 | GLN | Tape & Reel |
| | | Active High (Continuous 2.0A) | AP2822GKETR-G1 | GLO | Tape & Reel |
| | | Active Low (Continuous 2.0A) | AP2822HKETR-G1 | GLP | Tape & Reel |

BCD Semiconductor's Pb-free products, as designated with "G1" suffix in the part number, are RoHS compliant and green.

**0.5A to 2.0A High-side Power Distribution Switches****AP2822****Absolute Maximum Ratings (Note 1)**

| Parameter | Symbol | Value | Unit |
|--|---------------|--------------|-------------|
| Power Supply Voltage | V_{IN} | 6.0 | V |
| Operating Junction Temperature Range | T_J | 150 | °C |
| Storage Temperature Range | T_{STG} | -65 to 150 | °C |
| Lead Temperature (Soldering, 10sec) | T_{LEAD} | 260 | °C |
| Thermal Resistance (Junction to Ambient) | θ_{JA} | TBD | °C/W |
| ESD (Machine Model) | | 200 | V |
| ESD (Human Body Model) | | 2000 | V |

Note 1: Stresses greater than those listed under “Absolute Maximum Ratings” may cause permanent damage to the device. These are stress ratings only, and functional operation of the device at these or any other conditions beyond those indicated under “Recommended Operating Conditions” is not implied. Exposure to “Absolute Maximum Ratings” for extended periods may affect device reliability.

Recommended Operating Conditions

| Parameter | Symbol | Min | Max | Unit |
|-------------------------------------|---------------|------------|------------|-------------|
| Supply Voltage | V_{IN} | 2.7 | 5.5 | V |
| Operating Ambient Temperature Range | T_A | -40 | 85 | °C |



0.5A to 2.0A High-side Power Distribution Switches

AP2822

Electrical Characteristics

($V_{IN}=5.0V$, $C_{IN}=2.2\mu F$, $C_{OUT}=1.0\mu F$, Typical $T_A=25^\circ C$, unless otherwise specified)

| Parameter | Symbol | Condition | Min | Typ | Max | Unit |
|---|-----------------|--|------|-----|-----|------------|
| Supply Voltage | V_{IN} | | 2.7 | | 5.5 | V |
| Switch On Resistance | $R_{DS(ON)}$ | $V_{IN}=5.0V$, $I_{OUT}=2.0A$ | | 85 | 110 | m Ω |
| Current Limit | I_{LIMIT} | AP2822A/B(0.5A), $V_{OUT}=4.0V$ | 0.7 | 1.0 | 1.4 | A |
| | | AP2822C/D(1.0A), $V_{OUT}=4.0V$ | 1.1 | 1.5 | 2.1 | |
| | | AP2822E/F(1.5A), $V_{OUT}=4.0V$ | 1.65 | 2.2 | 2.8 | |
| | | AP2822G/H(2.0A), $V_{OUT}=4.0V$ | 2.2 | 2.7 | 3.2 | |
| Supply Current | I_{SUPPLY} | $V_{IN}=5.0V$, No Load | | 68 | 95 | μA |
| Fold-back Short Current | I_{SHORT} | AP2822 A/B/C/D, $V_{OUT}=0V$ | | 0.7 | | A |
| | | AP2822 E/F/G/H, $V_{OUT}=0V$ | | 1.1 | | |
| Shutdown Supply Current | $I_{SHUTDOWN}$ | Chip Disable, Shutdown Mode | | 0.1 | 1.0 | μA |
| Enable High Input Threshold | V_{ENH} | | 1.6 | | 5.5 | V |
| Enable Low Input Threshold | V_{ENL} | | 0 | | 1.0 | V |
| Enable Pin Input Current | I_{EN} | Force 0V to 5.0V at EN Pin | -1.0 | | 1.0 | μA |
| Under Voltage Lockout Threshold Voltage | V_{UVLO} | V_{IN} Increasing from 0V | 2.2 | 2.5 | 3.0 | V |
| Under Voltage Hysteresis | V_{UVLOHY} | | | 0.2 | | V |
| Reverse Current | $I_{REVERSE}$ | Chip Disable, $V_{OUT}>V_{IN}$ | | 0.1 | 1.0 | μA |
| Output Pull Low Resistance after Shutdown | $R_{DISCHARGE}$ | | | 100 | 200 | Ω |
| Output Turn-on Time | t_{ON} | From Enable Active to 90% of Output | | 500 | | μs |
| FLAG Pin Delay Time | t_{DFLG} | From Over Current Fault Condition to Flag Active | 5 | 10 | 15 | ms |
| FLAG Pin Low Voltage | V_{FLG} | $I_{SINK}=5.0mA$ | | 35 | 70 | mV |
| FLAG Pin Leakage Current | $I_{LEAKAGE}$ | FLAG Disable, Force 5.0V | | | 1.0 | μA |
| Thermal Shutdown Temperature | T_{OTSD} | | | 150 | | $^\circ C$ |
| Thermal Shutdown Hysteresis | T_{HYOTSD} | | | 30 | | |



0.5A to 2.0A High-side Power Distribution Switches

AP2822

Typical Performance Characteristics

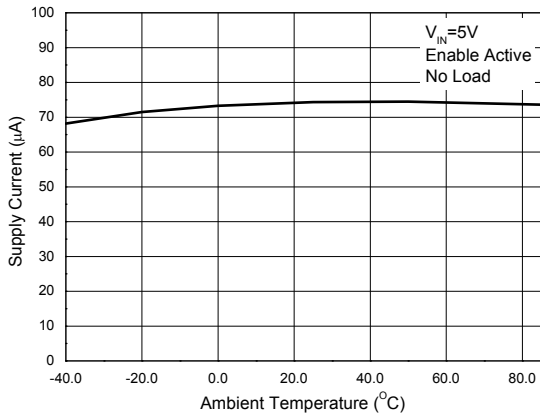

Figure 4. Supply Current vs. Ambient Temperature

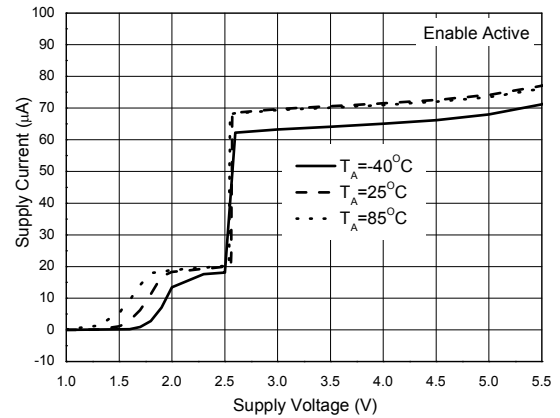

Figure 5. Supply Current vs. Supply Voltage

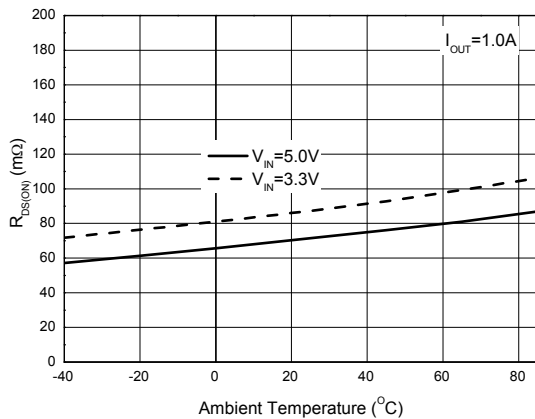

Figure 6. $R_{DS(ON)}$ vs. Ambient Temperature

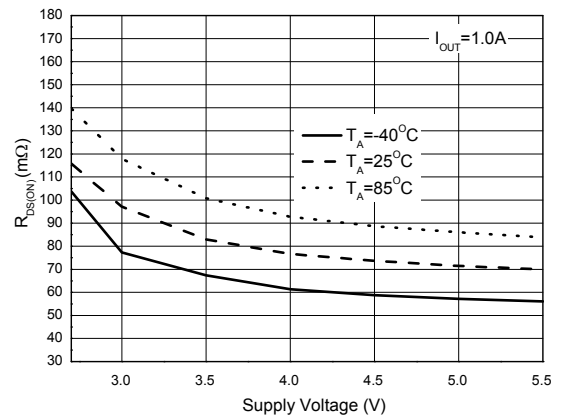

Figure 7. $R_{DS(ON)}$ vs. Supply Voltage

Typical Performance Characteristics (Continued)



Figure 8. Current Limit vs. Supply Voltage

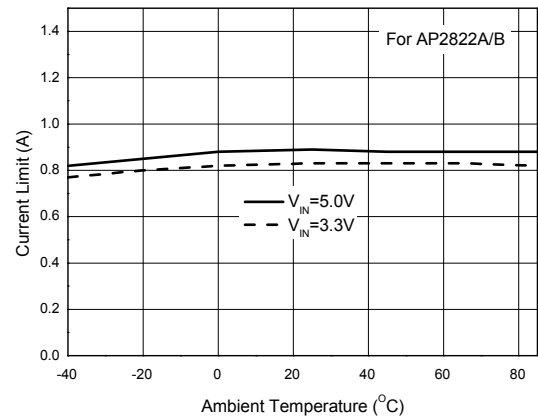

Figure 9. Current Limit vs. Ambient Temperature

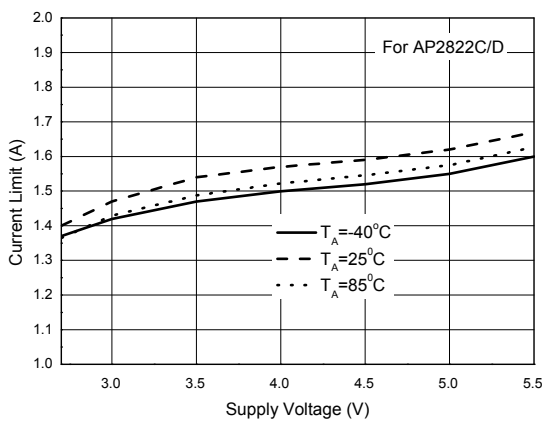

Figure 10. Current Limit vs. Supply Voltage

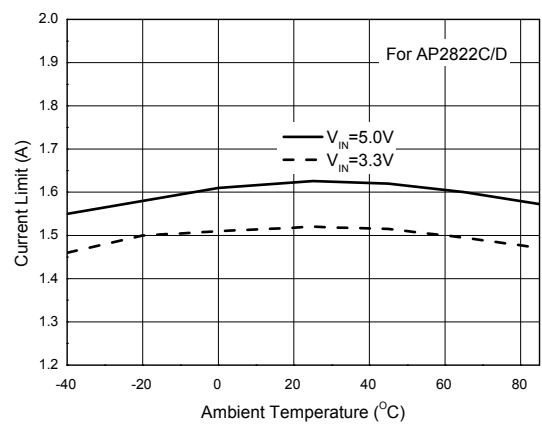

Figure 11. Current Limit vs. Ambient Temperature



0.5A to 2.0A High-side Power Distribution Switches

AP2822

Typical Performance Characteristics (Continued)

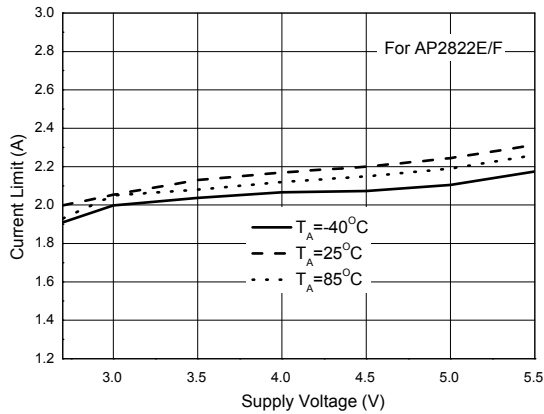

Figure 12. Current Limit vs. Supply Voltage

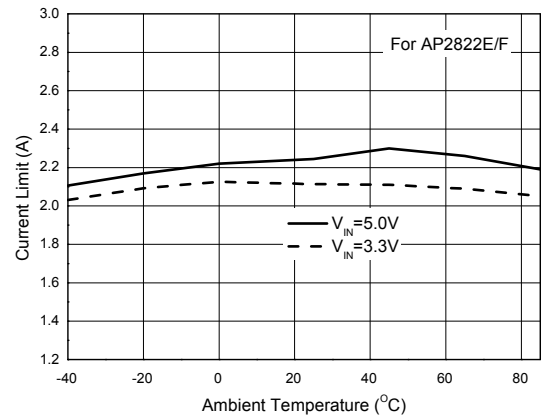

Figure 13. Current Limit vs. Ambient Temperature



Figure 14. Current Limit vs. Supply Voltage

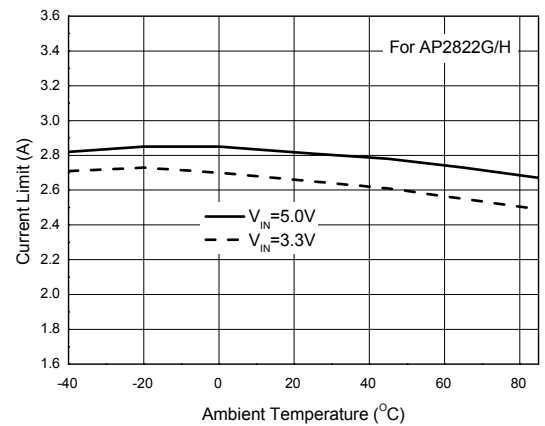

Figure 15. Current Limit vs. Ambient Temperature

Typical Performance Characteristics (Continued)

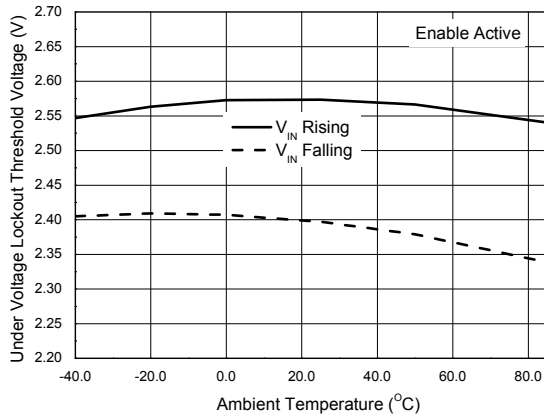

Figure 16. UVLO Voltage vs. Ambient Temperature

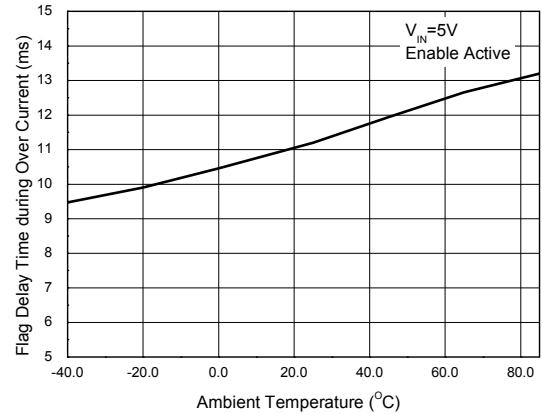

Figure 17. Flag Delay Time during Over Current vs. Ambient Temperature

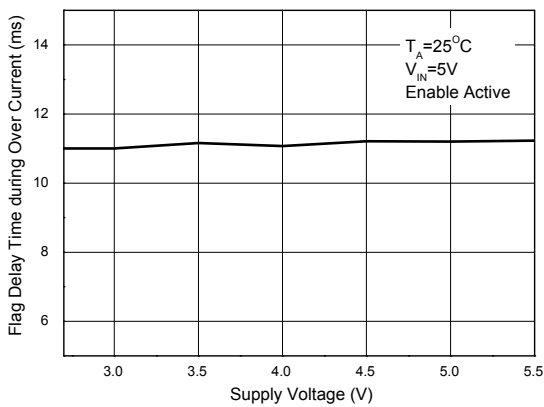

Figure 18. Flag Delay Time during Over Current vs. Supply Voltage



Figure 19. Output Short to GND Current vs. Supply Voltage

0.5A to 2.0A High-side Power Distribution Switches

AP2822

Typical Performance Characteristics (Continued)



Figure 20. Output Short to GND Current vs. Ambient Temperature

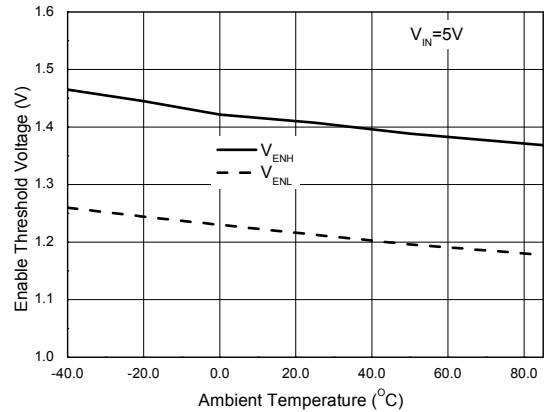

Figure 21. Enable Threshold Voltage vs. Ambient Temperature



Figure 22. Enable Threshold Voltage vs. Supply Voltage

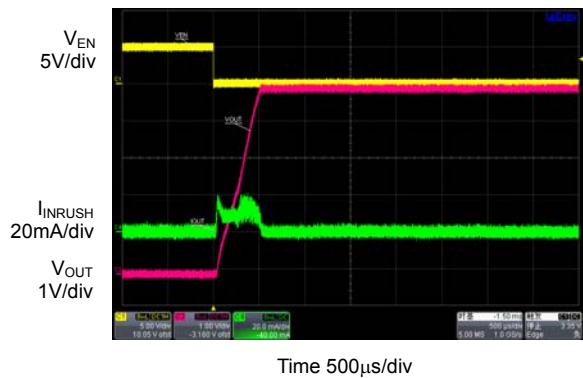

Figure 23. Output Turn On and Rise Time (C_{IN}=1.0µF, C_{OUT}=1.0µF, No Load)

0.5A to 2.0A High-side Power Distribution Switches

AP2822

Typical Performance Characteristics (Continued)



Time 500µs/div

Figure 24. Output Turn On and Rise Time
($C_{IN}=1.0\mu F$, $C_{OUT}=1.0\mu F$, $R_L=3.3\Omega$)

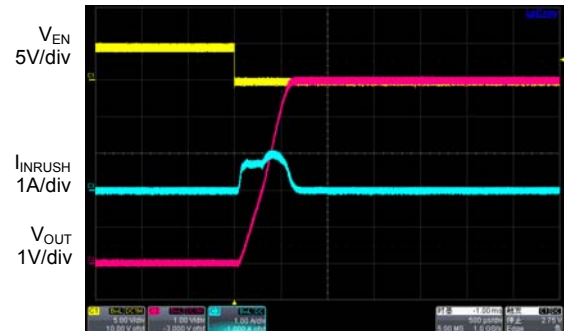

Time 500µs/div

Figure 25. Output Turn On and Rise Time
($C_{IN}=1.0\mu F$, $C_{OUT}=100\mu F$, No Load)

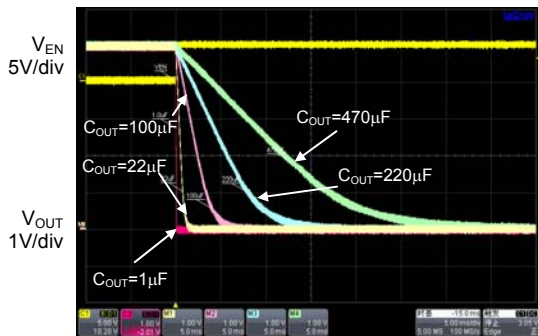

Time 5ms/div

Figure 26. Output Turn Off and Fall Time
($V_{IN}=5V$, $C_{IN}=1.0\mu F$, No Load)

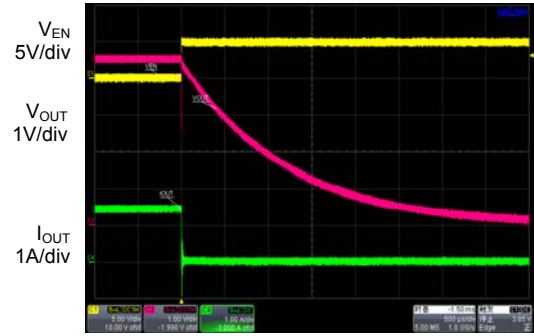

Time 500µs/div

Figure 27. Output Turn Off and Fall Time
($V_{IN}=5V$, $C_{IN}=1.0\mu F$, $C_{OUT}=470\mu F$, $R_L=3.3\Omega$)

0.5A to 2.0A High-side Power Distribution Switches

AP2822

Typical Performance Characteristics (Continued)



Time 20ms/div

Figure 28. Output Short to GND Current ($V_{IN}=5V$, $C_{IN}=1.0\mu F$)

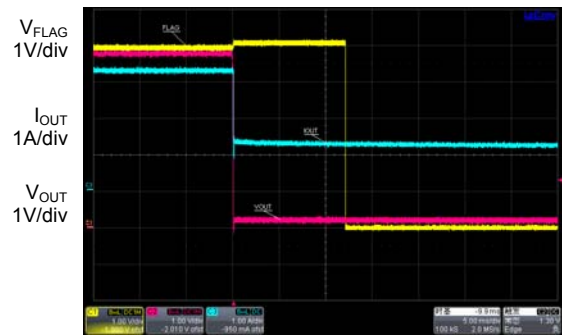

Time 5ms/div

Figure 29. FLAG Response during Over Current



Time 5ms/div

Figure 30. FLAG Response during Over Temperature ($T_A=125\text{ }^\circ\text{C}$)

Typical Application

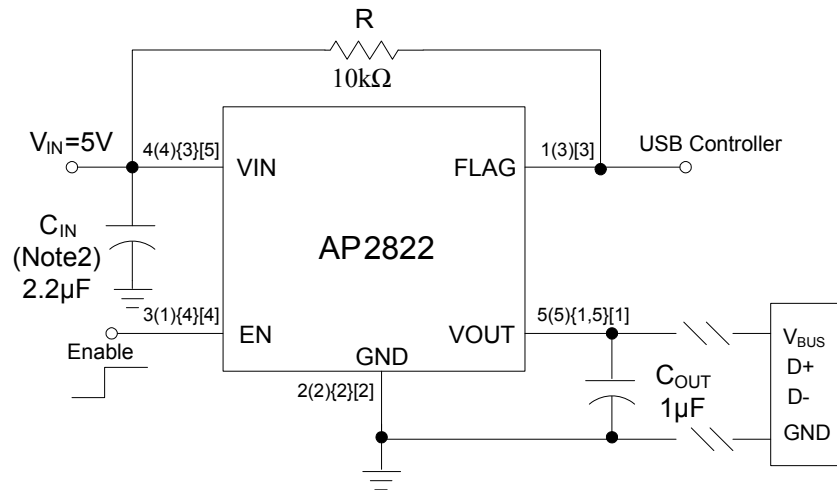

A(B){C}[D]
 A: SOT-23-5(K Package)
 B: SOT-23-5(KA Package)
 C: SOT-23-5(KB Package)
 D: SOT-23-5(KE Package)

Note 2: 2.2µF input capacitor is enough in most application cases.

If the VOUT is short to ground frequently during usage, large size input capacitor is necessary, recommend 22µF.

Figure 31. Typical Application of AP2822

0.5A to 2.0A High-side Power Distribution Switches

AP2822

Mechanical Dimensions

SOT-23-5

Unit: mm(inch)

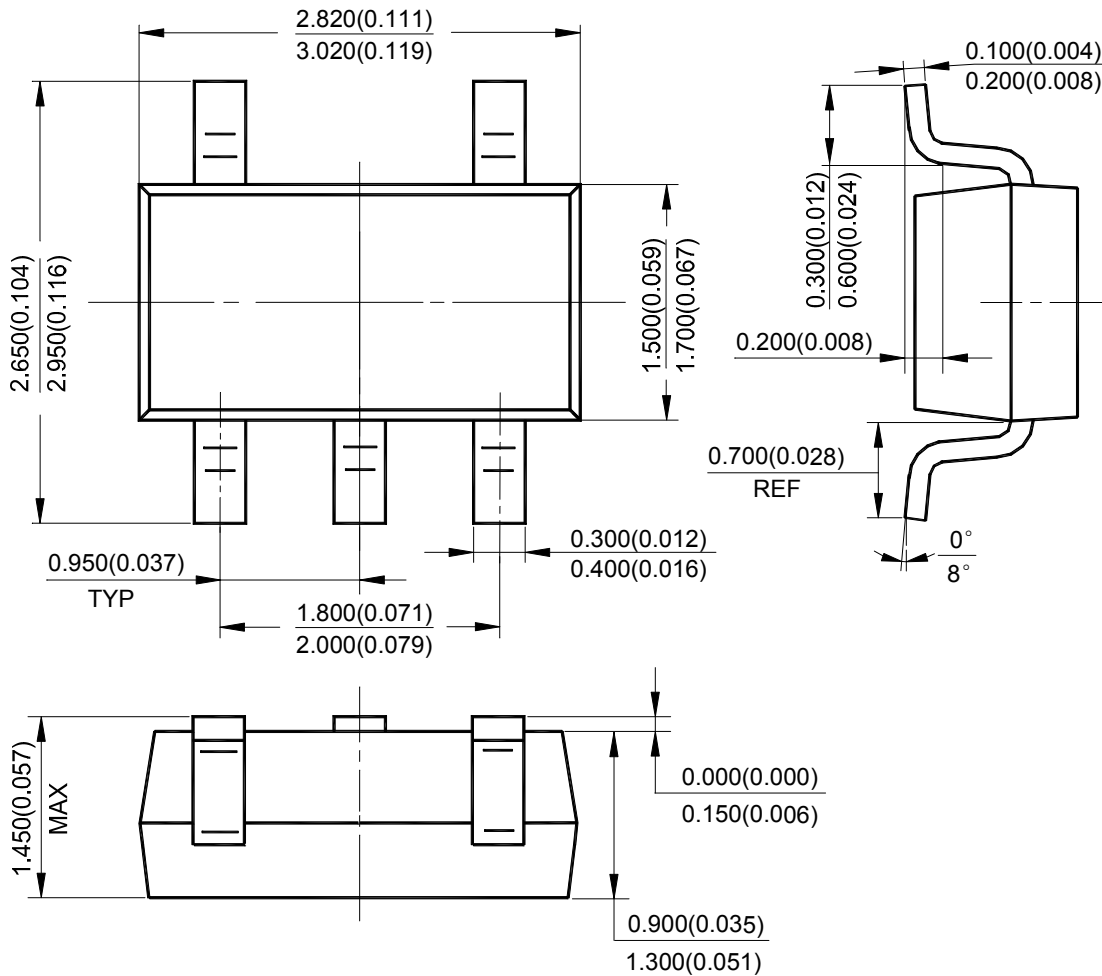



BCD Semiconductor Manufacturing Limited

<http://www.bcdsemi.com>

IMPORTANT NOTICE

BCD Semiconductor Manufacturing Limited reserves the right to make changes without further notice to any products or specifications herein. BCD Semiconductor Manufacturing Limited does not assume any responsibility for use of any its products for any particular purpose, nor does BCD Semiconductor Manufacturing Limited assume any liability arising out of the application or use of any its products or circuits. BCD Semiconductor Manufacturing Limited does not convey any license under its patent rights or other rights nor the rights of others.

MAIN SITE

- Headquarters

BCD Semiconductor Manufacturing Limited

No. 1600, Zi Xing Road, Shanghai ZiZhu Science-based Industrial Park, 200241, China
Tel: +86-21-24162266, Fax: +86-21-24162277

- Wafer Fab

Shanghai SIM-BCD Semiconductor Manufacturing Co., Ltd.

800 Yi Shan Road, Shanghai 200233, China
Tel: +86-21-6485 1491, Fax: +86-21-5450 0008

REGIONAL SALES OFFICE

Shenzhen Office

Shanghai SIM-BCD Semiconductor Manufacturing Co., Ltd., Shenzhen Office

Unit A Room 1203, Skyworth Bldg., Gaoxin Ave. 1.S., Nanshan District, Shenzhen, China
Tel: +86-755-8826 7951
Fax: +86-755-8826 7865

Taiwan Office

BCD Semiconductor (Taiwan) Company Limited

4F, 298-1, Rui Guang Road, Nei-Hu District, Taipei, Taiwan
Tel: +886-2-2656 2808
Fax: +886-2-2656 2806

USA Office

BCD Semiconductor Corp.

30920 Huntwood Ave. Hayward, CA 94544, USA
Tel : +1-510-324-2988
Fax: +1-510-324-2788

Данный компонент на территории Российской Федерации

Вы можете приобрести в компании MosChip.

Для оперативного оформления запроса Вам необходимо перейти по данной ссылке:

<http://moschip.ru/get-element>

Вы можете разместить у нас заказ для любого Вашего проекта, будь то серийное производство или разработка единичного прибора.

В нашем ассортименте представлены ведущие мировые производители активных и пассивных электронных компонентов.

Нашей специализацией является поставка электронной компонентной базы двойного назначения, продукции таких производителей как XILINX, Intel (ex.ALTERA), Vicor, Microchip, Texas Instruments, Analog Devices, Mini-Circuits, Amphenol, Glenair.

Сотрудничество с глобальными дистрибьюторами электронных компонентов, предоставляет возможность заказывать и получать с международных складов практически любой перечень компонентов в оптимальные для Вас сроки.

На всех этапах разработки и производства наши партнеры могут получить квалифицированную поддержку опытных инженеров.

Система менеджмента качества компании отвечает требованиям в соответствии с ГОСТ Р ИСО 9001, ГОСТ РВ 0015-002 и ЭС РД 009

Офис по работе с юридическими лицами:

105318, г.Москва, ул.Щербаковская д.3, офис 1107, 1118, ДЦ «Щербаковский»

Телефон: +7 495 668-12-70 (многоканальный)

Факс: +7 495 668-12-70 (доб.304)

E-mail: info@moschip.ru

Skype отдела продаж:

moschip.ru

moschip.ru_4

moschip.ru_6

moschip.ru_9