

# MAX5033

## 500mA, 76V, High-Efficiency, MAXPower Step-Down DC-DC Converter

### General Description

The MAX5033 easy-to-use, high-efficiency, high-voltage, step-down DC-DC converter operates from an input voltage up to 76V and consumes only 270 $\mu$ A quiescent current at no load. This pulse-width modulated (PWM) converter operates at a fixed 125kHz switching frequency at heavy loads, and automatically switches to pulseskipping mode to provide low quiescent current and high efficiency at light loads. The MAX5033 includes internal frequency compensation simplifying circuit implementation. The device uses an internal low-on-resistance, high-voltage, DMOS transistor to obtain high efficiency and reduce overall system cost. This device includes undervoltage lockout, cycle-by-cycle current limit, hiccup-mode output short-circuit protection, and thermal shutdown.

The MAX5033 delivers up to 500mA output current. The output current may be limited by the maximum power dissipation capability of the package. External shutdown is included, featuring 10 $\mu$ A (typ) shutdown current. The MAX5033A/B/C versions have fixed output voltages of 3.3V, 5V, and 12V, respectively, while the MAX5033D features an adjustable output voltage, from 1.25V to 13.2V.

The MAX5033 is available in space-saving 8-pin SO and 8-pin plastic DIP packages and operates over the automotive (-40°C to +125°C) temperature range.

### Applications

- Consumer Electronics
- Industrial
- Distributed Power

### Typical Application Circuit



### Features

- Wide 7.5V to 76V Input Voltage Range
- Fixed (3.3V, 5V, 12V) and Adjustable (1.25V to 13.2V) Voltage Versions
- 500mA Output Current
- Efficiency Up to 94%
- Internal 0.4 $\Omega$  High-Side DMOS FET
- 270 $\mu$ A Quiescent Current at No Load, 10 $\mu$ A Shutdown Current
- Internal Frequency Compensation
- Fixed 125kHz Switching Frequency
- Thermal Shutdown and Short-Circuit Current Limit
- 8-Pin SO and PDIP Packages

### Ordering Information

| PART         | TEMP RANGE      | PIN-PACKAGE | OUTPUT VOLTAGE (V) |
|--------------|-----------------|-------------|--------------------|
| MAX5033AUSA  | 0°C to +85°C    | 8 SO        | 3.3                |
| MAX5033AUPA  | 0°C to +85°C    | 8 PDIP      |                    |
| MAX5033AASA  | -40°C to +125°C | 8 SO        |                    |
| MAX5033BUS A | 0°C to +85°C    | 8 SO        | 5.0                |
| MAX5033BUP A | 0°C to +85°C    | 8 PDIP      |                    |
| MAX5033BAS A | -40°C to +125°C | 8 SO        |                    |
| MAX5033CUS A | 0°C to +85°C    | 8 SO        | 12                 |
| MAX5033CUP A | 0°C to +85°C    | 8 PDIP      |                    |
| MAX5033CAS A | -40°C to +125°C | 8 SO        |                    |
| MAX5033DUS A | 0°C to +85°C    | 8 SO        | ADJ                |
| MAX5033DUP A | 0°C to +85°C    | 8 PDIP      |                    |
| MAX5033DAS A | -40°C to +125°C | 8 SO        |                    |

This product is available in both leaded (Pb) and lead (Pb)-free packages. To order the lead (Pb)-free package, add a + after the part number.

### Pin Configuration

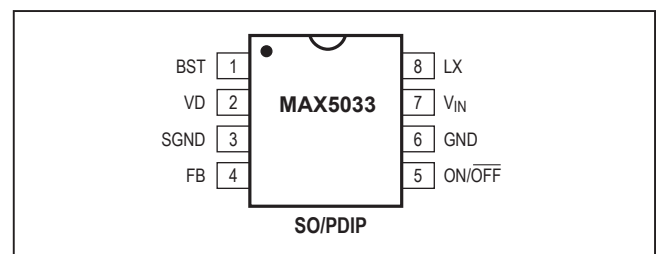

**Absolute Maximum Ratings**

(Voltages referenced to GND, unless otherwise specified.)

|  |                                   |
|--|-----------------------------------|
| V <sub>IN</sub> .....  | -0.3V to +80V                     |
| SGND .....   | -0.3V to +0.3V                    |
| LX.....  | -0.8V to (V <sub>IN</sub> + 0.3V) |
| BST.....   | -0.3V to (V <sub>IN</sub> + 10V)  |
| BST (transient < 100ns).....   | -0.3V to (V <sub>IN</sub> + 15V)  |
| BST to LX.....   | -0.3V to +10V                     |
| BST to LX (transient < 100ns) .....                                  | -0.3V to +15V                     |
| ON/OFF .....   | -0.3V to +80V                     |
| VD.....  | -0.3V to +12V                     |
| FB   |                                   |
| MAX5033A/MAX5033B/MAX5033C.....                                      | -0.3V to +15V                     |
| MAX5033D.....  | -0.3V to +12V                     |
| V <sub>OUT</sub> Short-Circuit Duration (V <sub>IN</sub> ≤ 40V)..... | Indefinite                        |

|   |                 |
|---|-----------------|
| VD Short-Circuit Duration.....                        | Indefinite      |
| Continuous Power Dissipation (T <sub>A</sub> = +70°C) |                 |
| 8-Pin PDIP (derate 9.1mW/°C above +70°C).....         | 727mW           |
| 8-Pin SO (derate 5.9mW/°C above +70°C).....           | 471mW           |
| Operating Temperature Range                           |                 |
| MAX5033_U_.....                                       | 0°C to +85°C    |
| MAX5033_A_.....                                       | -40°C to +125°C |
| Storage Temperature Range.....                        | -65°C to +150°C |
| Junction Temperature.....                             | +150°C          |
| Lead Temperature (soldering, 10s).....                | +300°C          |
| Soldering Temperature (reflow)                        |                 |
| SO, PDIP Lead(Pb)-free.....                           | +260°C          |
| SO, PDIP Containing lead (Pb).....                    | +240°C          |

Stresses beyond those listed under "Absolute Maximum Ratings" may cause permanent damage to the device. These are stress ratings only, and functional operation of the device at these or any other conditions beyond those indicated in the operational sections of the specifications is not implied. Exposure to absolute maximum rating conditions for extended periods may affect device reliability.

**Electrical Characteristics (MAX5033\_U\_)**

(V<sub>IN</sub> = +12V, V<sub>ON/OFF</sub> = +12V, I<sub>OUT</sub> = 0, T<sub>A</sub> = 0°C to +85°C, unless otherwise noted. Typical values are at T<sub>A</sub> = +25°C. See the Typical Operating Circuit.)

| PARAMETER                 | SYMBOL            | CONDITIONS  | MIN   | TYP   | MAX   | UNITS |
|---------------------------|-------------------|---|-------|-------|-------|-------|
| Input Voltage Range       | V <sub>IN</sub>   | MAX5033A  | 7.5   |       | 76.0  | V     |
|                           |                   | MAX5033B  | 7.5   |       | 76.0  |       |
|                           |                   | MAX5033C  | 15    |       | 76    |       |
|                           |                   | MAX5033D  | 7.5   |       | 76.0  |       |
| Undervoltage Lockout      | UVLO              |   | 5.2   |       |       | V     |
| Output Voltage            | V <sub>OUT</sub>  | MAX5033A, V <sub>IN</sub> = 7.5V to 76V, I <sub>OUT</sub> = 20mA to 500mA         | 3.185 | 3.3   | 3.415 | V     |
|                           |                   | MAX5033B, V <sub>IN</sub> = 7.5V to 76V, I <sub>OUT</sub> = 20mA to 500mA         | 4.85  | 5.0   | 5.15  |       |
|                           |                   | MAX5033C, V <sub>IN</sub> = 15V to 76V, I <sub>OUT</sub> = 20mA to 500mA          | 11.64 | 12    | 12.36 |       |
| Feedback Voltage          | V <sub>FB</sub>   | V <sub>IN</sub> = 7.5V to 76V, MAX5033D   | 1.192 | 1.221 | 1.250 | V     |
| Efficiency                | η                 | V <sub>IN</sub> = 12V, I <sub>LOAD</sub> = 500mA, MAX5033A                        |       | 86    |       | %     |
|                           |                   | V <sub>IN</sub> = 12V, I <sub>LOAD</sub> = 500mA, MAX5033B                        |       | 90    |       |       |
|                           |                   | V <sub>IN</sub> = 24V, I <sub>LOAD</sub> = 500mA, MAX5033C                        |       | 94    |       |       |
|                           |                   | V <sub>IN</sub> = 12V, V <sub>OUT</sub> = 5V, I <sub>LOAD</sub> = 500mA, MAX5033D |       | 90    |       |       |
| Quiescent Supply Current  | I <sub>Q</sub>    | V <sub>FB</sub> = 3.5V, V <sub>IN</sub> = 7.5V to 76V, MAX5033A                   |       | 270   | 440   | μA    |
|                           |                   | V <sub>FB</sub> = 5.5V, V <sub>IN</sub> = 7.5V to 76V, MAX5033B                   |       | 270   | 440   |       |
|                           |                   | V <sub>FB</sub> = 13V, V <sub>IN</sub> = 15V to 76V, MAX5033C                     |       | 270   | 440   |       |
|                           |                   | V <sub>FB</sub> = 1.3V, MAX5033D  |       | 270   | 440   |       |
| Shutdown Current          | I <sub>SHDN</sub> | V <sub>ON/OFF</sub> = 0V, V <sub>IN</sub> = 7.5V to 76V                           |       | 10    | 45    | μA    |
| Peak Switch Current Limit | I <sub>LIM</sub>  | (Note 1)  | 0.95  | 1.5   | 2.1   | A     |
| Switch Leakage Current    | I <sub>OL</sub>   | V <sub>IN</sub> = 76V, V <sub>ON/OFF</sub> = 0V, V <sub>LX</sub> = 0V             |       | 1     |       | μA    |

**Electrical Characteristics (MAX5033\_U\_ ) (continued)**

( $V_{IN} = +12V$ ,  $V_{ON/OFF} = +12V$ ,  $I_{OUT} = 0$ ,  $T_A = 0^{\circ}C$  to  $+85^{\circ}C$ , unless otherwise noted. Typical values are at  $T_A = +25^{\circ}C$ . See the *Typical Operating Circuit*.)

| PARAMETER                                   | SYMBOL                       | CONDITIONS                                 | MIN  | TYP   | MAX  | UNITS         |
|---|------------------------------|--|------|-------|------|---------------|
| Switch On-Resistance                        | $R_{DS(ON)}$                 | $I_{SWITCH} = 500mA$                       |      | 0.4   | 0.80 | $\Omega$      |
| PFM Threshold                               | $I_{PFM}$                    | Minimum switch current in any cycle        | 35   | 65    | 95   | mA            |
| FB Input Bias Current                       | $I_B$                        | MAX5033D                                   | -150 | +0.01 | +150 | nA            |
| <b>ON/OFF CONTROL INPUT</b>                 |                              |  |      |       |      |               |
| ON/OFF Input-Voltage Threshold              | $V_{ON/OFF}$                 | Rising trip point                          | 1.53 | 1.69  | 1.85 | V             |
| ON/OFF Input-Voltage Hysteresis             | $V_{HYST}$                   |  |      | 100   |      | mV            |
| ON/OFF Input Current                        | $I_{ON/OFF}$                 | $V_{ON/OFF} = 0V$ to $V_{IN}$              |      | 10    | 150  | nA            |
| ON/OFF Operating Voltage Range              | $V_{ON/OFF}$                 |  |      |       | 76   | V             |
| <b>OSCILLATOR</b>                           |                              |  |      |       |      |               |
| Oscillator Frequency                        | $f_{OSC}$                    |  | 109  | 125   | 135  | kHz           |
| Maximum Duty Cycle                          | $D_{MAX}$                    | MAX5033D                                   |      | 95    |      | %             |
| <b>VOLTAGE REGULATOR</b>                    |                              |  |      |       |      |               |
| Regulator Output Voltage                    | $V_D$                        | $V_{IN} = 8.5V$ to $76V$ , $I_L = 0mA$     | 6.9  | 7.8   | 8.8  | V             |
| Dropout Voltage                             |                              | $7.5V \leq V_{IN} \leq 8.5V$ , $I_L = 1mA$ |      | 2.0   |      | V             |
| Load Regulation                             | $\Delta V_D / \Delta I_{VD}$ | 0 to 5mA                                   |      | 150   |      | $\Omega$      |
| <b>PACKAGE THERMAL CHARACTERISTICS</b>      |                              |  |      |       |      |               |
| Thermal Resistance<br>(Junction to Ambient) | $\theta_{JA}$                | SO package (JEDEC 51)                      |      | 170   |      | $^{\circ}C/W$ |
|   |                              | DIP package (JEDEC 51)                     |      | 110   |      |               |
| <b>THERMAL SHUTDOWN</b>                     |                              |  |      |       |      |               |
| Thermal-Shutdown Junction<br>Temperature    | $T_{SH}$                     |  |      | +160  |      | $^{\circ}C$   |
| Thermal-Shutdown Hysteresis                 | $T_{HYST}$                   |  |      | 20    |      | $^{\circ}C$   |

**Electrical Characteristics (MAX5033\_A\_ )**

( $V_{IN} = +12V$ ,  $V_{ON/OFF} = +12V$ ,  $I_{OUT} = 0$ ,  $T_A = T_J = -40^{\circ}C$  to  $+125^{\circ}C$ , unless otherwise noted. Typical values are at  $T_A = +25^{\circ}C$ . See the *Typical Operating Circuit*.) (Note 2)

| PARAMETER            | SYMBOL    | CONDITIONS  | MIN   | TYP | MAX   | UNITS |
|----------------------|-----------|---|-------|-----|-------|-------|
| Input Voltage Range  | $V_{IN}$  | MAX5033A  | 7.5   |     | 76.0  | V     |
|                      |           | MAX5033B  | 7.5   |     | 76.0  |       |
|                      |           | MAX5033C  | 15    |     | 76    |       |
|                      |           | MAX5033D  | 7.5   |     | 76.0  |       |
| Undervoltage Lockout | UVLO      |   | 5.2   |     |       | V     |
| Output Voltage       | $V_{OUT}$ | MAX5033A, $V_{IN} = 7.5V$ to $76V$ ,<br>$I_{OUT} = 20mA$ to $500mA$ | 3.185 | 3.3 | 3.415 | V     |
|                      |           | MAX5033B, $V_{IN} = 7.5V$ to $76V$ ,<br>$I_{OUT} = 20mA$ to $500mA$ | 4.825 | 5.0 | 5.175 |       |
|                      |           | MAX5033C, $V_{IN} = 15V$ to $76V$ ,<br>$I_{OUT} = 20mA$ to $500mA$  | 11.58 | 12  | 12.42 |       |

**Electrical Characteristics (MAX5033\_A\_ ) (continued)**

( $V_{IN} = +12V$ ,  $V_{ON/OFF} = +12V$ ,  $I_{OUT} = 0$ ,  $T_A = T_J = -40^{\circ}C$  to  $+125^{\circ}C$ , unless otherwise noted. Typical values are at  $T_A = +25^{\circ}C$ . See the *Typical Operating Circuit.*) (Note 2)

| PARAMETER                                | SYMBOL                       | CONDITIONS  | MIN   | TYP   | MAX   | UNITS         |
|--|------------------------------|---|-------|-------|-------|---------------|
| Feedback Voltage                         | $V_{FB}$                     | $V_{IN} = 7.5V$ to 76V, MAX5033D                                | 1.192 | 1.221 | 1.250 | V             |
| Efficiency                               | $\eta$                       | $V_{IN} = 12V$ , $I_{LOAD} = 500mA$ , MAX5033A                  |       | 86    |       | %             |
|  |                              | $V_{IN} = 12V$ , $I_{LOAD} = 500mA$ , MAX5033B                  |       | 90    |       |               |
|  |                              | $V_{IN} = 24V$ , $I_{LOAD} = 500mA$ , MAX5033C                  |       | 94    |       |               |
|  |                              | $V_{IN} = 12V$ , $V_{OUT} = 5V$ , $I_{LOAD} = 500mA$ , MAX5033D |       | 90    |       |               |
| Quiescent Supply Current                 | $I_Q$                        | $V_{FB} = 3.5V$ , $V_{IN} = 7.5V$ to 76V, MAX5033A              |       | 270   | 440   | $\mu A$       |
|  |                              | $V_{FB} = 5.5V$ , $V_{IN} = 7.5V$ to 76V, MAX5033B              |       | 270   | 440   |               |
|  |                              | $V_{FB} = 13V$ , $V_{IN} = 15V$ to 76V, MAX5033C                |       | 270   | 440   |               |
|  |                              | $V_{FB} = 1.3V$ , MAX5033D                                      |       | 270   | 440   |               |
| Shutdown Current                         | $I_{SHDN}$                   | $V_{ON/OFF} = 0V$ , $V_{IN} = 7.5V$ to 76V                      |       | 10    | 45    | $\mu A$       |
| Peak Switch Current Limit                | $I_{LIM}$                    | (Note 1)  | 0.95  | 1.5   | 2.1   | A             |
| Switch Leakage Current                   | $I_{OL}$                     | $V_{IN} = 76V$ , $V_{ON/OFF} = 0V$ , $V_{LX} = 0V$              |       | 1     |       | $\mu A$       |
| Switch On-Resistance                     | $R_{DS(ON)}$                 | $I_{SWITCH} = 500mA$  |       | 0.4   | 0.80  | $\Omega$      |
| PFM Threshold                            | $I_{PFM}$                    | Minimum switch current in any cycle                             | 35    | 65    | 110   | mA            |
| FB Input Bias Current                    | $I_B$                        | MAX5033D  | -150  | +0.01 | +150  | nA            |
| <b>ON/OFF CONTROL INPUT</b>              |                              |   |       |       |       |               |
| ON/OFF Input-Voltage Threshold           | $V_{ON/OFF}$                 | Rising trip point   | 1.50  | 1.69  | 1.85  | V             |
| ON/OFF Input-Voltage Hysteresis          | $V_{HYST}$                   |   |       | 100   |       | mV            |
| ON/OFF Input Current                     | $I_{ON/OFF}$                 | $V_{ON/OFF} = 0V$ to $V_{IN}$                                   |       | 10    | 150   | nA            |
| ON/OFF Operating Voltage Range           | $V_{ON/OFF}$                 |   |       |       | 76    | V             |
| <b>OSCILLATOR</b>                        |                              |   |       |       |       |               |
| Oscillator Frequency                     | $f_{OSC}$                    |   | 105   | 125   | 137   | kHz           |
| Maximum Duty Cycle                       | $D_{MAX}$                    | MAX5033D  |       | 95    |       | %             |
| <b>VOLTAGE REGULATOR</b>                 |                              |   |       |       |       |               |
| Regulator Output Voltage                 | $V_D$                        | $V_{IN} = 8.5V$ to 76V, $I_L = 0mA$                             | 6.5   | 7.8   | 9.0   | V             |
| Dropout Voltage                          |                              | $7.5V \leq V_{IN} \leq 8.5V$ , $I_L = 1mA$                      |       | 2.0   |       | V             |
| Load Regulation                          | $\Delta V_D / \Delta I_{VD}$ | 0 to 5mA  |       | 150   |       | $\Omega$      |
| <b>PACKAGE THERMAL CHARACTERISTICS</b>   |                              |   |       |       |       |               |
| Thermal Resistance (Junction to Ambient) | $\theta_{JA}$                | SO package (JEDEC 51)   |       | 170   |       | $^{\circ}C/W$ |
|  |                              | DIP package (JEDEC 51)  |       | 110   |       |               |
| <b>THERMAL SHUTDOWN</b>                  |                              |   |       |       |       |               |
| Thermal-Shutdown Junction Temperature    | $T_{SH}$                     |   |       | +160  |       | $^{\circ}C$   |
| Thermal-Shutdown Hysteresis              | $T_{HYST}$                   |   |       | 20    |       | $^{\circ}C$   |

**Note 1:** Switch current at which the current limit is activated.

**Note 2:** All limits at  $-40^{\circ}C$  are guaranteed by design, not production tested.

Typical Operating Characteristics

( $V_{IN} = 12V$ ,  $V_{ON/OFF} = 12V$ ,  $T_A = -40^{\circ}C$  to  $+125^{\circ}C$ , unless otherwise noted. Typical values are at  $T_A = +25^{\circ}C$ . See the *Typical Operating Circuit*, if applicable.)

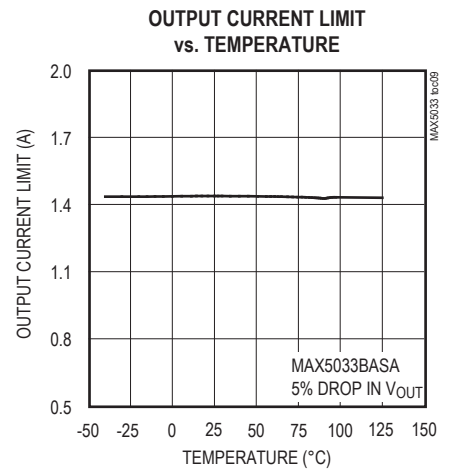
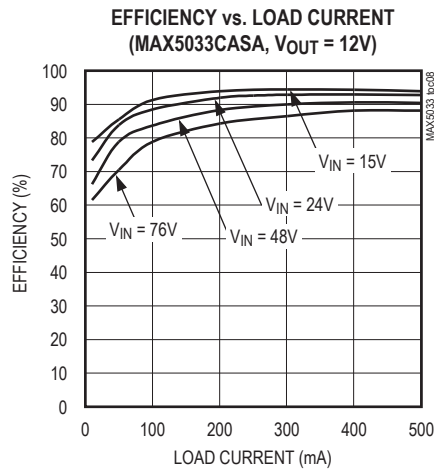
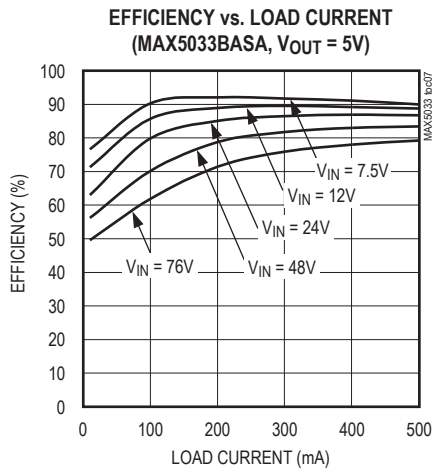
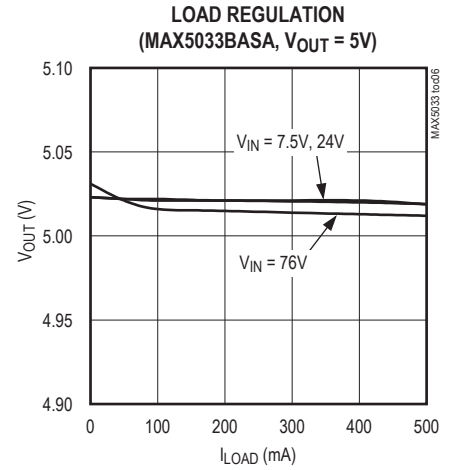
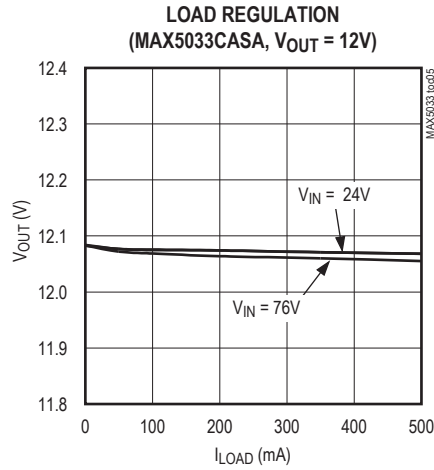
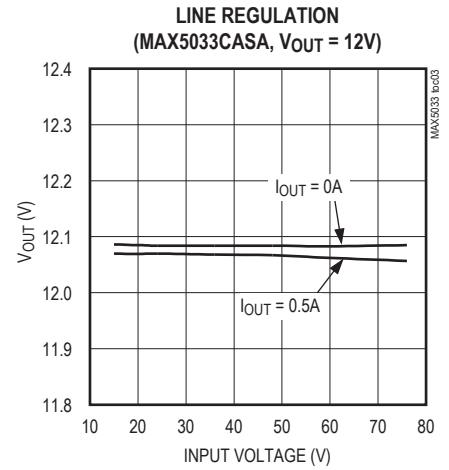
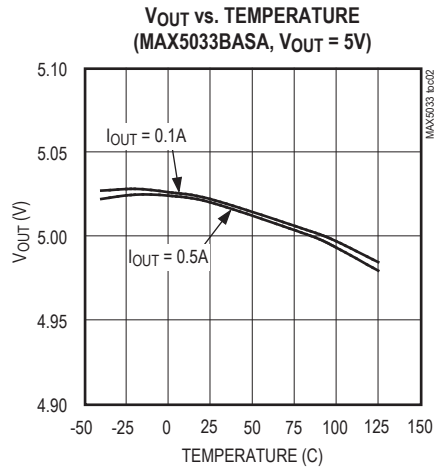

Typical Operating Characteristics (continued)

( $V_{IN} = 12V$ ,  $V_{ON/OFF} = 12V$ ,  $T_A = -40^{\circ}C$  to  $+125^{\circ}C$ , unless otherwise noted. Typical values are at  $T_A = +25^{\circ}C$ . See the *Typical Operating Circuit*, if applicable.)



A:  $V_{OUT}$ , 200mV/div, AC-COUPLED  
B:  $I_{OUT}$ , 500mA/div, 100mA TO 500mA

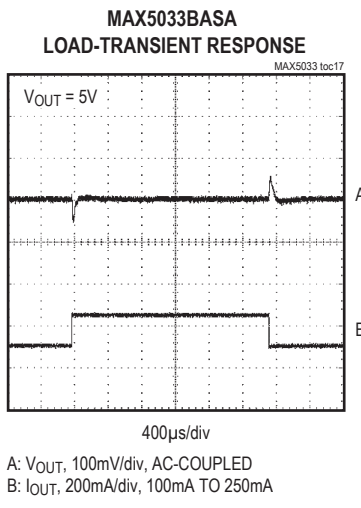

A:  $V_{OUT}$ , 100mV/div, AC-COUPLED  
B:  $I_{OUT}$ , 200mA/div, 100mA TO 250mA

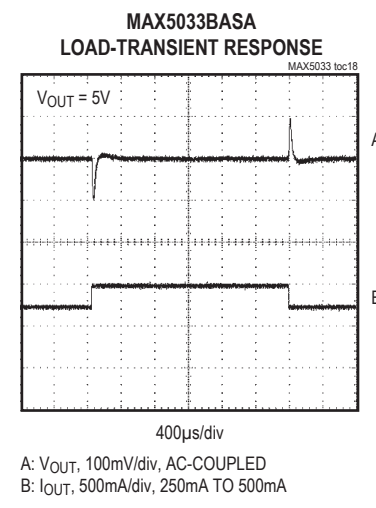

A:  $V_{OUT}$ , 100mV/div, AC-COUPLED  
B:  $I_{OUT}$ , 500mA/div, 250mA TO 500mA

Typical Operating Characteristics (continued)

( $V_{IN} = 12V$ ,  $V_{ON/OFF} = 12V$ ,  $T_A = -40^{\circ}C$  to  $+125^{\circ}C$ , unless otherwise noted. Typical values are at  $T_A = +25^{\circ}C$ . See the *Typical Operating Circuit*, if applicable.)



A: SWITCH VOLTAGE (LX PIN) 20V/div,  $V_{IN} = 48V$   
 B: INDUCTOR CURRENT, 200mA/div, ( $I_{OUT} = 500mA$ )

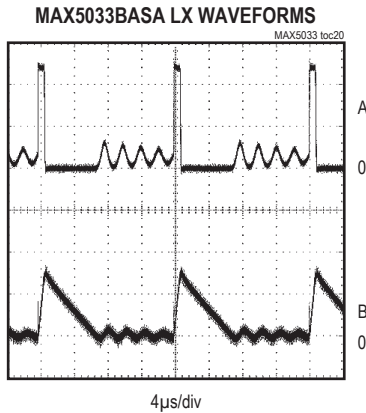

A: SWITCH VOLTAGE, 20V/div,  $V_{IN} = 48V$   
 B: INDUCTOR CURRENT, 100mA/div ( $I_{OUT} = 30mA$ )

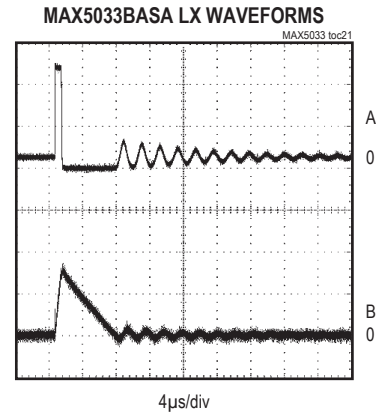

A: SWITCH VOLTAGE (LX PIN), 20V/div,  $V_{IN} = 48V$   
 B: INDUCTOR CURRENT, 100mA/div ( $I_{OUT} = 0$ )

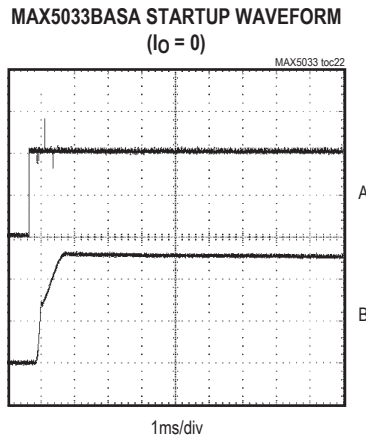

A:  $V_{ON/OFF}$ , 2V/div  
 B:  $V_{OUT}$ , 2V/div

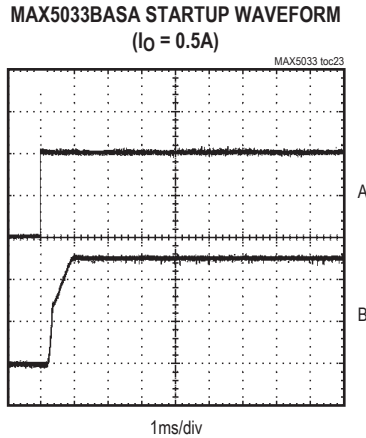

A:  $V_{ON/OFF}$ , 2V/div  
 B:  $V_{OUT}$ , 2V/div

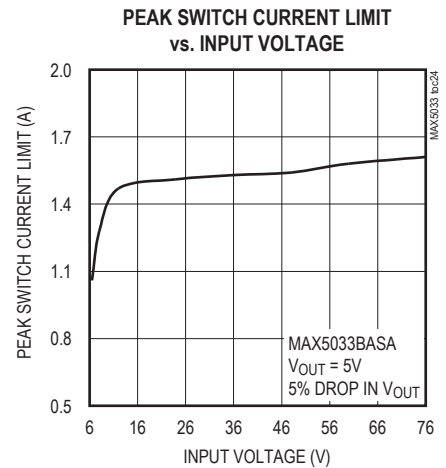

Pin Description

| PIN | NAME                        | FUNCTION   |
|-----|-----------------------------|--|
| 1   | BST                         | Boost Capacitor Connection. Connect a 0.1μF ceramic capacitor from BST to LX.  |
| 2   | VD                          | Internal Regulator Output. Bypass VD to GND with a 0.1μF ceramic capacitor.  |
| 3   | SGND                        | Internal Connection. SGND must be connected to GND.  |
| 4   | FB                          | Output Sense Feedback Connection. For fixed output voltage (MAX5033A, MAX5033B, MAX5033C), connect FB to V <sub>OUT</sub> . For adjustable output voltage (MAX5033D), use an external resistive voltage-divider to set V <sub>OUT</sub> . V <sub>FB</sub> regulating set point is 1.22V. |
| 5   | ON/ $\overline{\text{OFF}}$ | Shutdown Control Input. Pull ON/ $\overline{\text{OFF}}$ low to put the device in shutdown mode. Drive ON/ $\overline{\text{OFF}}$ high for normal operation.  |
| 6   | GND                         | Ground.  |
| 7   | V <sub>IN</sub>             | Input Voltage. Bypass V <sub>IN</sub> to GND with a low-ESR capacitor as close to the device as possible.  |
| 8   | LX                          | Source Connection of Internal High-Side Switch.  |

Simplified Block Diagram





## Detailed Description

The MAX5033 step-down DC-DC converter operates from a 7.5V to 76V input voltage range. A unique voltage-mode control scheme with voltage feed-forward and an internal switching DMOS FET provides high efficiency over a wide input voltage range. This pulse-width modulated converter operates at a fixed 125kHz switching frequency. The device also features automatic pulse-skipping mode to provide low quiescent current and high efficiency at light loads. Under no load, the MAX5033 consumes only 270µA, and in shutdown mode, consumes only 10µA. The MAX5033 also features undervoltage lockout, hiccup-mode output shortcircuit protection, and thermal shutdown.

### Shutdown Mode

Drive ON/OFF to ground to shut down the MAX5033. Shutdown forces the internal power MOSFET off, turns off all internal circuitry, and reduces the  $V_{IN}$  supply current to 10µA (typ). The ON/OFF rising threshold is 1.69V (typ). Before any operation begins, the voltage at ON/OFF must exceed 1.69V (typ). The ON/OFF input has 100mV hysteresis.

### Undervoltage Lockout (UVLO)

Use the ON/OFF function to program the UVLO threshold at the input. Connect a resistive voltage-divider from  $V_{IN}$  to GND with the center node to ON/OFF as shown in Figure 1. Calculate the threshold value by using the following formula:

$$V_{UVLO(TH)} = \left(1 + \frac{R1}{R2}\right) \times 1.85V$$

The minimum recommended  $V_{UVLO(TH)}$  is 6.5V, 7.5V, and 13V for the output voltages of 3.3V, 5V, and 12V, respectively. The recommended value for R2 is less than 1MΩ.

If the external UVLO threshold-setting divider is not used, an internal undervoltage-lockout feature monitors the supply voltage at  $V_{IN}$  and allows operation to start when  $V_{IN}$  rises above 5.2V (typ). This feature can be used only when  $V_{IN}$  rise time is faster than 2ms. For slower  $V_{IN}$  rise time, use the resistive divider at ON/OFF.

### Boost High-Side Gate Drive (BST)

Connect a flying bootstrap capacitor between LX and BST to provide the gate-drive voltage to the high-side n-channel DMOS switch. The capacitor is alternately charged from the internally regulated output-voltage VD and placed across the high-side DMOS driver. Use a 0.1µF, 16V ceramic capacitor located as close to the device as possible.

On startup, an internal low-side switch connects LX to ground and charges the BST capacitor to VD. Once the BST capacitor is charged, the internal low-side switch is turned off and the BST capacitor voltage provides the necessary enhancement voltage to turn on the high-side switch.

### Thermal-Overload Protection

The MAX5033 features integrated thermal-overload protection. Thermal-overload protection limits total power dissipation in the device, and protects the device in the event of a fault condition. When the die temperature exceeds +160°C, an internal thermal sensor signals the shutdown logic, turning off the internal power MOSFET and allowing the IC to cool. The thermal sensor turns the internal power MOSFET back on after the IC's die temperature cools down to +140°C, resulting in a pulsed output under continuous thermal-overload conditions.

## Applications Information

### Setting the Output Voltage

The MAX5033A/B/C have preset output voltages of 3.3V, 5.0V, and 12V, respectively. Connect FB to the preset output voltage (see the Typical Operating Circuit).

The MAX5033D offers an adjustable output voltage. Set the output voltage with a resistive voltage-divider connected from the circuit's output to ground (Figure 1). Connect the center node of the divider to FB. Choose R4 less than 15kΩ, then calculate R3 as follows:

$$R3 = \frac{(V_{OUT} - 1.22)}{1.22} \times R4$$



Figure 1. Adjustable Output Voltage

The MAX5033 features internal compensation for optimum closed-loop bandwidth and phase margin. With the preset compensation, it is strongly advised to sense the output immediately after the primary LC.

### Inductor Selection

The choice of an inductor is guided by the voltage difference between  $V_{IN}$  and  $V_{OUT}$ , the required output current, and the operating frequency of the circuit. Use an inductor with a minimum value given by:

$$L = \frac{(V_{IN} - V_{OUT}) \times D}{0.3 \times I_{OUTMAX} \times f_{SW}}$$

where:  $D = V_{OUT}/V_{IN}$ ,  $I_{OUTMAX}$  is the maximum output current required, and  $f_{SW}$  is the operating frequency of 125kHz. Use an inductor with a maximum saturation current rating equal to at least the peak switch current limit ( $I_{LIM}$ ). Use inductors with low DC resistance for higher efficiency.

### Selecting a Rectifier

The MAX5033 requires an external Schottky rectifier as a freewheeling diode. Connect this rectifier close to the device using short leads and short PC board traces. Choose a rectifier with a continuous current rating greater than the highest expected output current. Use a rectifier with a voltage rating greater than the maximum expected input voltage,  $V_{IN}$ . Use a low forward-voltage Schottky rectifier for proper operation and high efficiency. Avoid higher than necessary reverse-voltage Schottky rectifiers that have higher forward-voltage drops. Use a Schottky rectifier with forward-voltage drop ( $V_{FB}$ ) less than 0.45V at +25°C and maximum load current to avoid forward biasing of the internal body diode (LX to ground). Internal body-diode conduction may cause excessive junction

**Table 1. Diode Selection**

| $V_{IN}$ (V) | DIODE PART NUMBER | MANUFACTURER          |
|--------------|-------------------|-----------------------|
| 7.5 to 36    | 15MQ040N          | IR                    |
|              | B240A             | Diodes Incorporated   |
|              | B240              | Central Semiconductor |
|              | MBRS240, MBRS1540 | ON Semiconductor      |
| 7.5 to 56    | 30BQ060           | IR                    |
|              | B360A             | Diodes Incorporated   |
|              | CMSH3-60          | Central Semiconductor |
|              | MBRD360, MBR3060  | ON Semiconductor      |
| 7.5 to 76    | 50SQ100, 50SQ80   | IR                    |
|              | MBRM5100          | Diodes Incorporated   |

temperature rise and thermal shutdown. Use Table 1 to choose the proper rectifier at different input voltages and output current.

### Input Bypass Capacitor

The discontinuous input-current waveform of the buck converter causes large ripple currents in the input capacitor. The switching frequency, peak inductor current, and the allowable peak-to-peak voltage ripple that reflects back to the source dictate the capacitance requirement. The MAX5033 high switching frequency allows the use of smaller-value input capacitors.

The input ripple is comprised of  $\Delta V_Q$  (caused by the capacitor discharge) and  $\Delta V_{ESR}$  (caused by the ESR of the capacitor). Use low-ESR aluminum electrolytic capacitors with high ripple-current capability at the input. Assuming that the contribution from the ESR and capacitor discharge is equal to 90% and 10%, respectively, calculate the input capacitance and the ESR required for a specified ripple using the following equations:

$$ESR_{IN} = \frac{\Delta V_{ESR}}{\left( I_{OUT} + \frac{\Delta I_L}{2} \right)}$$

$$C_{IN} = \frac{I_{OUT} \times D(1-D)}{\Delta V_Q \times f_{SW}}$$

where:

$$\Delta I_L = \frac{(V_{IN} - V_{OUT}) \times V_{OUT}}{V_{IN} \times f_{SW} \times L}$$

$$D = \frac{V_{OUT}}{V_{IN}}$$

$I_{OUT}$  is the maximum output current of the converter and  $f_{SW}$  is the oscillator switching frequency (125kHz). For example, at  $V_{IN} = 48V$  and  $V_{OUT} = 3.3V$ , the ESR and input capacitance are calculated for the input peak-to-peak ripple of 100mV or less, yielding an ESR and capacitance value of 130mΩ and 27μF, respectively.

Low-ESR, ceramic, multilayer chip capacitors are recommended for size-optimized application. For ceramic capacitors, assume the contribution from ESR and capacitor discharge is equal to 10% and 90%, respectively.

The input capacitor must handle the RMS ripple current without significant rise in temperature. The maximum capacitor RMS current occurs at about 50% duty cycle.

Ensure that the ripple specification of the input capacitor exceeds the worst-case capacitor RMS ripple current. Use the following equations to calculate the input capacitor RMS current:

$$I_{CRMS} = \sqrt{I_{PRMS}^2 - I_{AVGIN}^2}$$

where :

$$I_{PRMS} = \sqrt{(I_{PK}^2 + I_{DC}^2 + (I_{PK} \times I_{DC})) \times \frac{D}{3}}$$

$$I_{AVGIN} = \frac{V_{OUT} \times I_{OUT}}{V_{IN} \times \eta}$$

$$I_{PK} = I_{OUT} + \frac{\Delta I_L}{2}, I_{DC} = I_{OUT} - \frac{\Delta I_L}{2}$$

$$\text{and } D = \frac{V_{OUT}}{V_{IN}}$$

$I_{PRMS}$  is the input switch RMS current,  $I_{AVGIN}$  is the input average current, and  $\eta$  is the converter efficiency.

The ESR of aluminum electrolytic capacitors increases significantly at cold temperatures. Use a 1 $\mu$ F or greater value ceramic capacitor in parallel with the aluminum electrolytic input capacitor, especially for input voltages below 8V.

### Output Filter Capacitor

The worst-case peak-to-peak and RMS capacitor ripple current, allowable peak-to-peak output ripple voltage, and the maximum deviation of the output voltage during load steps determine the capacitance and the ESR requirements for the output capacitors.

The output capacitance and its ESR form a zero, which improves the closed-loop stability of the buck regulator. Choose the output capacitor so the ESR zero frequency ( $f_z$ ) occurs between 20kHz to 40kHz. Use the following equation to verify the value of  $f_z$ . Capacitors with 100m $\Omega$  to 250m $\Omega$  ESR are recommended to ensure the closed-loop stability while keeping the output ripple low.

$$f_z = \frac{1}{2 \times \pi \times C_{OUT} \times ESR_{OUT}}$$

The output ripple is comprised of  $\Delta V_{OQ}$  (caused by the capacitor discharge) and  $\Delta V_{OESR}$  (caused by the ESR of the capacitor). Use low-ESR tantalum or aluminum electrolytic capacitors at the output. Assuming that the contributions from the ESR and capacitor discharge equal 80% and 20%, respectively, calculate the output capacitance and the ESR required for a specified ripple using the following equations:

$$ESR_{OUT} = \frac{\Delta V_{OESR}}{\Delta I_L}$$

$$C_{OUT} \approx \frac{\Delta I_L}{2.2 \times \Delta V_{OQ} \times f_{SW}}$$

The MAX5033 has an internal soft-start time ( $t_{SS}$ ) of 400 $\mu$ s. It is important to keep the output rise time at startup below  $t_{SS}$  to avoid output overshoot. The output rise time is directly proportional to the output capacitor. Use 68 $\mu$ F or lower capacitance at the output to control the overshoot below 5%.

In a dynamic load application, the allowable deviation of the output voltage during the fast-transient load dictates the output capacitance value and the ESR. The output capacitors supply the step load current until the controller responds with a greater duty cycle. The response time ( $t_{RESPONSE}$ ) depends on the closed-loop bandwidth of the converter. The resistive drop across the capacitor ESR and capacitor discharge cause a voltage droop during a step load. Use a combination of low-ESR tantalum and ceramic capacitors for better transient load and ripple/noise performance. Keep the maximum output-voltage deviation above the tolerable limits of the electronics being powered. Assuming a 50% contribution from the output capacitance discharge and the ESR drop, use the following equations to calculate the required ESR and capacitance value:

$$ESR_{OUT} = \frac{\Delta V_{OESR}}{I_{STEP}}$$

$$C_{OUT} = \frac{I_{STEP} \times t_{RESPONSE}}{\Delta V_{OQ}}$$

where  $I_{STEP}$  is the load step and  $t_{RESPONSE}$  is the response time of the controller. Controller response time is approximately one-third of the reciprocal of the closed-loop unity-gain bandwidth, 20kHz (typ).

### PCB Layout Considerations

Proper PCB layout is essential. Minimize ground noise by connecting the anode of the Schottky rectifier, the input bypass-capacitor ground lead, and the output filter-capacitor ground lead to a single point (star-ground configuration). A ground plane is required. Minimize lead lengths to reduce stray capacitance, trace resistance, and radiated noise. In particular, place the Schottky rectifier diode right next to the device. Also, place BST and VD bypass capacitors very close to the device. Use the PCB copper plane connecting to  $V_{IN}$  and LX for heatsinking.

Application Circuit

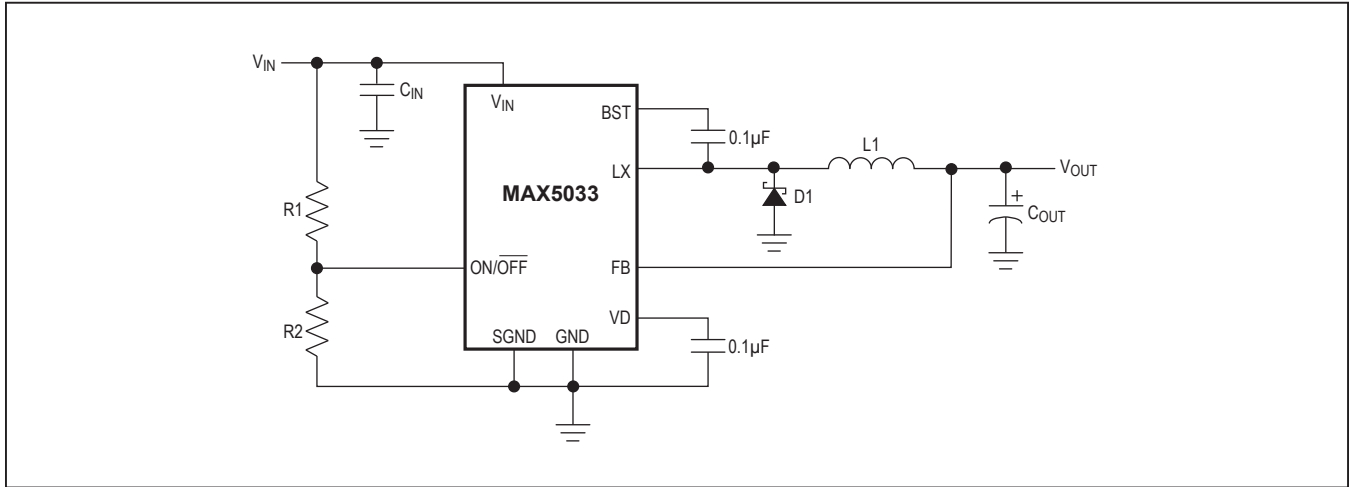

Figure 2. Fixed Output Voltages

Table 2. Typical External Components Selection (Circuit of Figure 2)

| V <sub>IN</sub> (V) | V <sub>OUT</sub> (V) | I <sub>OUT</sub> (A) | EXTERNAL COMPONENTS   |
|---------------------|----------------------|----------------------|---|
| 7.5 to 76           | 3.3                  | 0.5                  | C <sub>IN</sub> = 47µF, Panasonic, EEVFK2A470Q<br>C <sub>OUT</sub> = 47µF, Vishay Sprague, 594D476X_016C2T<br>C <sub>BST</sub> = 0.1µF, 0805<br>R1 = 1MΩ ±1%, 0805<br>R2 = 384kΩ ±1%, 0805<br>D1 = 50SQ100, IR<br>L1 = 150µH, Coilcraft Inc., DO5022P-154 |
| 7.5 to 76           | 5                    | 0.5                  | C <sub>IN</sub> = 47µF, Panasonic, EEVFK2A470Q<br>C <sub>OUT</sub> = 33µF, Vishay Sprague, 594D336X_016C2T<br>C <sub>BST</sub> = 0.1µF, 0805<br>R1 = 1MΩ ±1%, 0805<br>R2 = 384kΩ ±1%, 0805<br>D1 = 50SQ100, IR<br>L1 = 220µH, Coilcraft Inc., DO5022P-224 |
| 15 to 76            | 12                   | 0.5                  | C <sub>IN</sub> = 47µF, Panasonic, EEVFK2A470Q<br>C <sub>OUT</sub> = 15µF, Vishay Sprague, 594D156X_025C2T<br>C <sub>BST</sub> = 0.1µF, 0805<br>R1 = 1MΩ ±1%, 0805<br>R2 = 384kΩ ±1%, 0805<br>D1 = 50SQ100, IR<br>L1 = 330µH, Coilcraft Inc., DO5022P-334 |

**Table 2. Typical External Components Selection (Circuit of Figure 2) (continued)**

| V <sub>IN</sub> (V) | V <sub>OUT</sub> (V) | I <sub>OUT</sub> (A) | EXTERNAL COMPONENTS  |
|---------------------|----------------------|----------------------|--|
| 9 to 14             | 3.3                  | 0.5                  | C <sub>IN</sub> = 100μF, Panasonic, EEVFK1E101P<br>C <sub>OUT</sub> = 47μF, Vishay Sprague, 594D476X_016C2T<br>C <sub>BST</sub> = 0.1μF, 0805<br>R1 = 1MΩ ±1%, 0805<br>R2 = 274kΩ ±1%, 0805<br>D1 = B220/A, Diodes Incorporated<br>L1 = 150μH, Coilcraft Inc., DO5022P-154 |
|                     | 5                    | 0.5                  | C <sub>IN</sub> = 100μF, Panasonic, EEVFK1E101P<br>C <sub>OUT</sub> = 33μF, Vishay Sprague, 594D336X_016C2T<br>C <sub>BST</sub> = 0.1μF, 0805<br>R1 = 1MΩ ±1%, 0805<br>R2 = 274kΩ ±1%, 0805<br>D1 = B220/A, Diodes Incorporated<br>L1 = 220μH, Coilcraft Inc., DO5022P-224 |
| 18 to 36            | 3.3                  | 0.5                  | C <sub>IN</sub> = 100μF, Panasonic, EEVFK1H101P<br>C <sub>OUT</sub> = 47μF, Vishay Sprague, 594D476X_016C2T<br>C <sub>BST</sub> = 0.1μF, 0805<br>R1 = 1MΩ ±1%, 0805<br>R2 = 130kΩ ±1%, 0805<br>D1 = B240/A, Diodes Incorporated<br>L1 = 150μH, Coilcraft Inc., DO5022P-154 |
|                     | 5                    | 0.5                  | C <sub>IN</sub> = 100μF, Panasonic, EEVFK1H101P<br>C <sub>OUT</sub> = 33μF, Vishay Sprague, 594D336X_016C2T<br>C <sub>BST</sub> = 0.1μF, 0805<br>R1 = 1MΩ ±1%, 0805<br>R2 = 130kΩ ±1%, 0805<br>D1 = B240/A, Diodes Incorporated<br>L1 = 220μH, Coilcraft Inc., DO5022P-224 |
|                     | 12                   | 0.5                  | C <sub>IN</sub> = 100μF, Panasonic, EEVFK1H101P<br>C <sub>OUT</sub> = 15μF, Vishay Sprague, 594D156X_025C2T<br>C <sub>BST</sub> = 0.1μF, 0805<br>R1 = 1MΩ ±1%, 0805<br>R2 = 130kΩ ±1%, 0805<br>D1 = B240/A, Diodes Incorporated<br>L1 = 330μH, Coilcraft Inc., DO5022P-334 |

**Table 3. Component Suppliers**

| SUPPLIER            | PHONE        | FAX          | WEBSITE               |
|---------------------|--------------|--------------|-----------------------|
| AVX                 | 843-946-0238 | 843-626-3123 | www.avxcorp.com       |
| Coilcraft           | 847-639-6400 | 847-639-1469 | www.coilcraft.com     |
| Diodes Incorporated | 805-446-4800 | 805-446-4850 | www.diodes.com        |
| Nichicon            | 858-824-1515 | 858-824-1525 | www.nichicon.com      |
| Panasonic           | 714-373-7366 | 714-737-7323 | www.panasonic.com     |
| SANYO               | 619-661-6835 | 619-661-1055 | www.sanyo.com         |
| TDK                 | 847-803-6100 | 847-390-4405 | www.component.tdk.com |
| Vishay              | 402-563-6866 | 402-563-6296 | www.vishay.com        |



Figure 3. Load Temperature Monitoring with ON/OFF (Requires Accurate VIN)

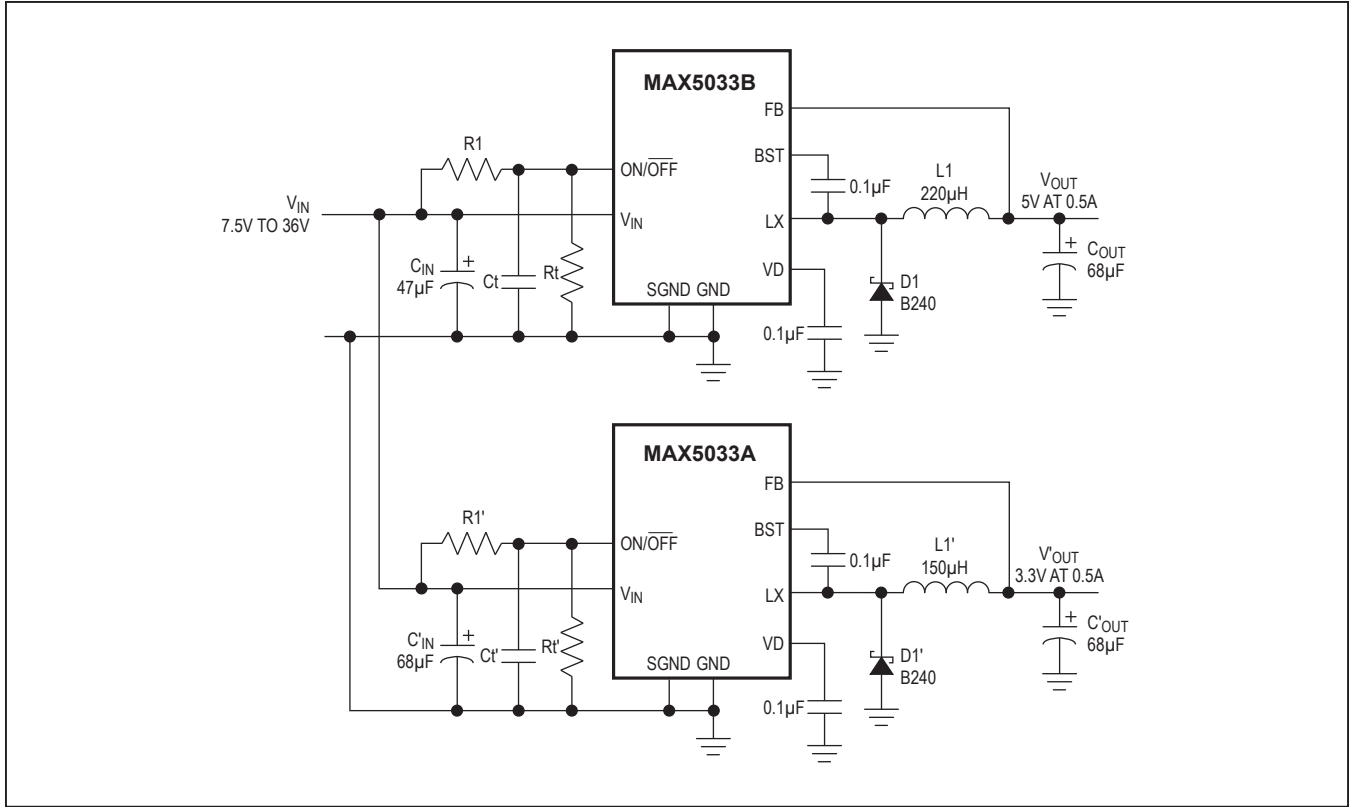

Figure 4. Dual-Sequenced DC-DC Converters (Startup Delay Determined by  $R1/R1'$ ,  $Ct/Ct'$  and  $Rt/Rt'$ )

### Chip Information

PROCESS: BICMOS

MAX5033

500mA, 76V, High-Efficiency, MAXPower  
Step-Down DC-DC Converter

### Package Information

For the latest package outline information and land patterns (footprints), go to [www.maximintegrated.com/packages](http://www.maximintegrated.com/packages). Note that a "+", "#", or "-" in the package code indicates RoHS status only. Package drawings may show a different suffix character, but the drawing pertains to the package regardless of RoHS status.

| PACKAGE TYPE | PACKAGE CODE | OUTLINE NO.             | LAND PATTERN NO.        |
|--------------|--------------|-------------------------|-------------------------|
| 8 PDIP       | P8+3         | <a href="#">21-0043</a> | —                       |
| 8 SO         | S8+5         | <a href="#">21-0041</a> | <a href="#">90-0096</a> |



## Revision History

| REVISION NUMBER | REVISION DATE | DESCRIPTION  | PAGES CHANGED  |
|-----------------|---------------|--|----------------|
| 0               | 9/03          | Initial release  | —              |
| 1               | 5/04          | New product update   | 1–7, 10        |
| 2               | 6/04          | Removed future product asterisk and made specification changes   | 1, 2, 3        |
| 3               | 1/07          | Modified <i>Absolute Maximum Ratings</i> specifications  | 2              |
| 4               | 4/10          | Corrected inconsistencies in <i>Absolute Maximum Ratings</i> and <i>Electrical Characteristics</i> table | 1, 2, 3, 4, 17 |
| 5               | 4/14          | No <i>IV</i> OPNs; removed Automotive reference in <i>Applications</i> section                           | 1              |

For pricing, delivery, and ordering information, please contact Maxim Direct at 1-888-629-4642, or visit Maxim Integrated's website at [www.maximintegrated.com](http://www.maximintegrated.com).

Maxim Integrated cannot assume responsibility for use of any circuitry other than circuitry entirely embodied in a Maxim Integrated product. No circuit patent licenses are implied. Maxim Integrated reserves the right to change the circuitry and specifications without notice at any time. The parametric values (min and max limits) shown in the *Electrical Characteristics* table are guaranteed. Other parametric values quoted in this data sheet are provided for guidance.

## Данный компонент на территории Российской Федерации

### Вы можете приобрести в компании MosChip.

Для оперативного оформления запроса Вам необходимо перейти по данной ссылке:

<http://moschip.ru/get-element>

Вы можете разместить у нас заказ для любого Вашего проекта, будь то серийное производство или разработка единичного прибора.

В нашем ассортименте представлены ведущие мировые производители активных и пассивных электронных компонентов.

Нашей специализацией является поставка электронной компонентной базы двойного назначения, продукции таких производителей как XILINX, Intel (ex.ALTERA), Vicor, Microchip, Texas Instruments, Analog Devices, Mini-Circuits, Amphenol, Glenair.

Сотрудничество с глобальными дистрибьюторами электронных компонентов, предоставляет возможность заказывать и получать с международных складов практически любой перечень компонентов в оптимальные для Вас сроки.

На всех этапах разработки и производства наши партнеры могут получить квалифицированную поддержку опытных инженеров.

Система менеджмента качества компании отвечает требованиям в соответствии с ГОСТ Р ИСО 9001, ГОСТ РВ 0015-002 и ЭС РД 009

### Офис по работе с юридическими лицами:

105318, г.Москва, ул.Щербаковская д.3, офис 1107, 1118, ДЦ «Щербаковский»

Телефон: +7 495 668-12-70 (многоканальный)

Факс: +7 495 668-12-70 (доб.304)

E-mail: [info@moschip.ru](mailto:info@moschip.ru)

Skype отдела продаж:

moschip.ru

moschip.ru\_4

moschip.ru\_6

moschip.ru\_9