

BAV23CLT1G, BAV23CLT3G

Dual High Voltage Common Cathode Switching Diode

Features

- Moisture Sensitivity Level: 1
- ESD Rating – Human Body Model: Class 2
– Machine Model: Class C
- Fast Switching Speed
- Switching Application
- These Devices are Pb-Free, Halogen Free/BFR Free and are RoHS Compliant

Typical Applications

- LCD TV
- Power Supply
- Industrial

MAXIMUM RATINGS

Rating	Symbol	Value	Unit
Continuous Reverse Voltage	V_R	250	V
Repetitive Peak Reverse Voltage	V_{RRM}	250	V
Peak Forward Current	I_F	400	mA
Non-Repetitive Peak Forward Surge Current	I_{FSM}	9.0 3.0 1.7	A
		@ $t = 1.0 \mu s$	
		@ $t = 100 \mu s$	
		@ $t = 10 ms$	
Peak Forward Surge Current	$I_{FM(surge)}$	625	mAdc
Non-Repetitive Peak Per Human Body Model	HBM	4.0	kV
Per Machine Model	MM	400	V

Stresses exceeding Maximum Ratings may damage the device. Maximum Ratings are stress ratings only. Functional operation above the Recommended Operating Conditions is not implied. Extended exposure to stresses above the Recommended Operating Conditions may affect device reliability.



ON Semiconductor®

<http://onsemi.com>

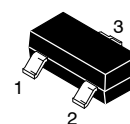
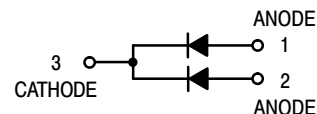

SOT-23
CASE 318
STYLE 9

MARKING DIAGRAM

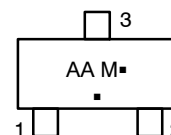

AA = Specific Device Code

M = Date Code

▪ = Pb-Free Package

(Note: Microdot may be in either location)

ORDERING INFORMATION

Device	Package	Shipping†
BAV23CLT1G	SOT-23 (Pb-Free)	3000 / Tape & Reel
BAV23CLT3G	SOT-23 (Pb-Free)	10000 / Tape & Reel

†For information on tape and reel specifications, including part orientation and tape sizes, please refer to our Tape and Reel Packaging Specifications Brochure, BRD8011/D.

BAV23CLT1G, BAV23CLT3G

THERMAL CHARACTERISTICS

Characteristic	Symbol	Max	Unit
----------------	--------	-----	------

SINGLE HEATED

Total Device Dissipation (Note 1) $T_A = 25^\circ\text{C}$ Derate above 25°C	P_D	265 2.1	mW mW/ $^\circ\text{C}$
Thermal Resistance, Junction-to-Ambient (Note 1)	$R_{\theta JA}$	472	$^\circ\text{C}/\text{W}$
Thermal Reference, Junction-to-Anode Lead (Note 1)	$R_{\psi JL}$	263	$^\circ\text{C}/\text{W}$
Thermal Reference, Junction-to-Case (Note 1)	$R_{\psi JC}$	289	$^\circ\text{C}/\text{W}$
Total Device Dissipation (Note 2) $T_A = 25^\circ\text{C}$ Derate above 25°C	P_D	345 2.7	mW mW/ $^\circ\text{C}$
Thermal Resistance, Junction-to-Ambient (Note 2)	$R_{\theta JA}$	362	$^\circ\text{C}/\text{W}$
Thermal Reference, Junction-to-Anode Lead (Note 2)	$R_{\psi JL}$	251	$^\circ\text{C}/\text{W}$
Thermal Reference, Junction-to-Case (Note 2)	$R_{\psi JC}$	250	$^\circ\text{C}/\text{W}$

DUAL HEATED (Note 3)

Total Device Dissipation (Note 1) $T_A = 25^\circ\text{C}$ Derate above 25°C	P_D	390 3.1	mW mW/ $^\circ\text{C}$
Thermal Resistance, Junction-to-Ambient (Note 1)	$R_{\theta JA}$	321	$^\circ\text{C}/\text{W}$
Thermal Reference, Junction-to-Anode Lead (Note 1)	$R_{\psi JL}$	159	$^\circ\text{C}/\text{W}$
Thermal Reference, Junction-to-Case (Note 1)	$R_{\psi JC}$	138	$^\circ\text{C}/\text{W}$
Total Device Dissipation (Note 2) $T_A = 25^\circ\text{C}$ Derate above 25°C	P_D	540 4.3	mW mW/ $^\circ\text{C}$
Thermal Resistance, Junction-to-Ambient (Note 2)	$R_{\theta JA}$	231	$^\circ\text{C}/\text{W}$
Thermal Reference, Junction-to-Anode Lead (Note 2)	$R_{\psi JL}$	148	$^\circ\text{C}/\text{W}$
Thermal Reference, Junction-to-Case (Note 2)	$R_{\psi JC}$	119	$^\circ\text{C}/\text{W}$
Junction and Storage Temperature Range	T_J, T_{stg}	-55 to +150	$^\circ\text{C}$

1. FR-4 @ 100 mm², 1 oz. copper traces, still air.
2. FR-4 @ 500 mm², 2 oz. copper traces, still air.
3. Dual heated values assume total power is sum of two equally powered channels

ELECTRICAL CHARACTERISTICS ($T_A = 25^\circ\text{C}$ unless otherwise noted)

Characteristic	Symbol	Min	Max	Unit
----------------	--------	-----	-----	------

OFF CHARACTERISTICS

Reverse Voltage Leakage Current ($V_R = 200\text{ Vdc}$) ($V_R = 200\text{ Vdc}, T_J = 150^\circ\text{C}$)	I_R	- -	0.1 100	μAdc
Reverse Breakdown Voltage ($I_{BR} = 100\ \mu\text{Adc}$)	$V_{(BR)}$	250	-	Vdc
Forward Voltage ($I_F = 100\ \text{mAdc}$) ($I_F = 200\ \text{mAdc}$)	V_F	- -	1000 1250	mV
Diode Capacitance ($V_R = 0, f = 1.0\ \text{MHz}$)	C_T	-	5.0	pF
Reverse Recovery Time ($I_F = I_R = 30\ \text{mAdc}, R_L = 100\ \Omega$)	t_{rr}	-	150	ns

BAV23CLT1G, BAV23CLT3G

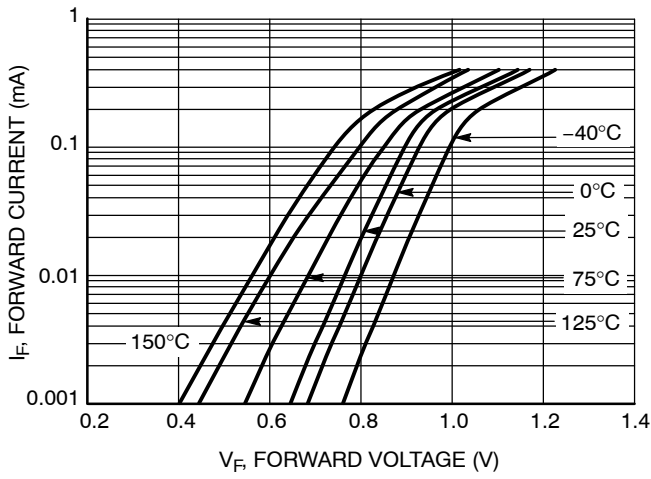

Figure 1. Forward Voltage

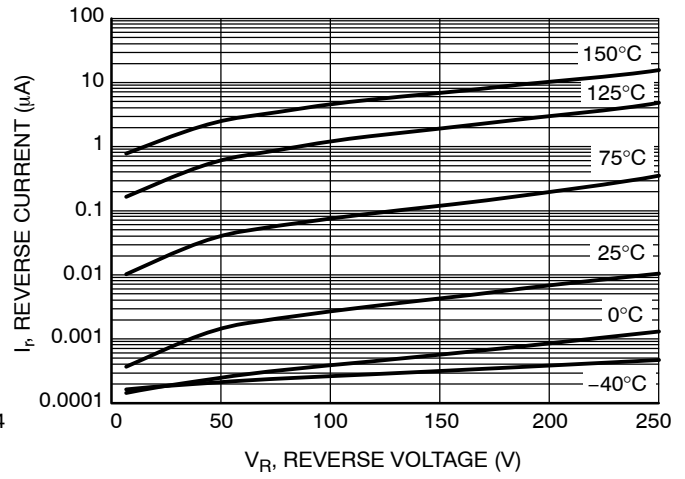

Figure 2. Reverse Current

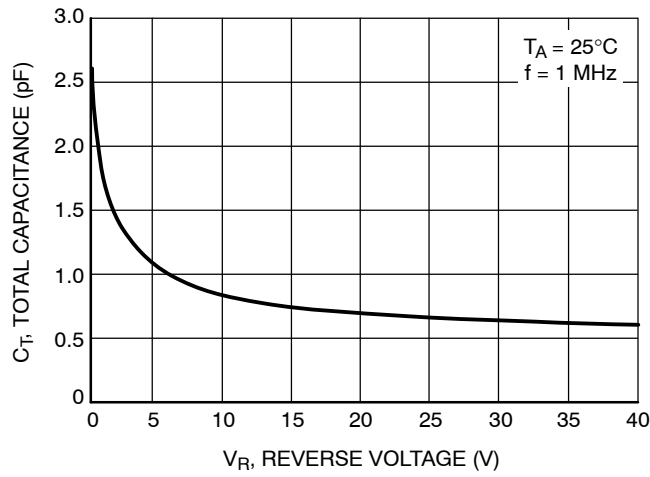
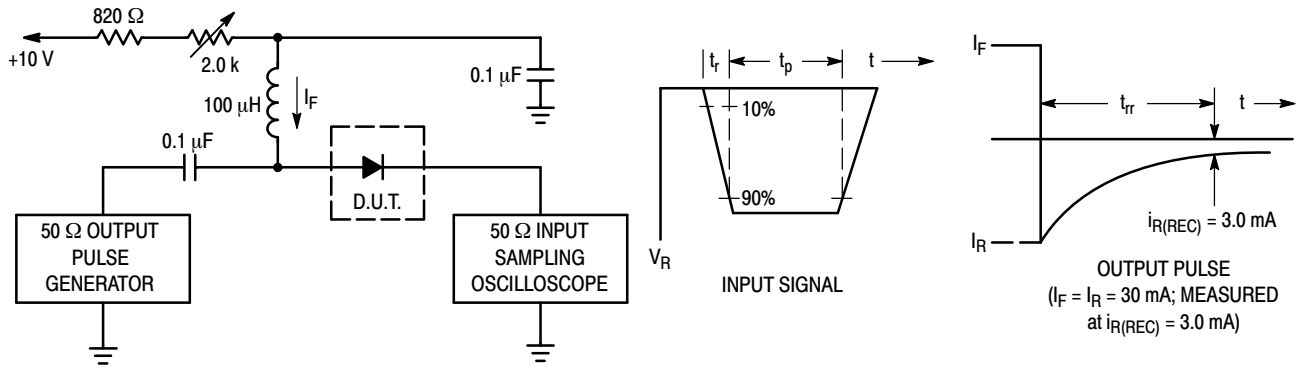

Figure 3. Total Capacitance



- Notes: 1. A 2.0 kΩ variable resistor adjusted for a Forward Current (I_F) of 30 mA.
 2. Input pulse is adjusted so $I_{R(peak)}$ is equal to 30 mA.
 3. $t_p \gg t_{rr}$

Figure 4. Recovery Time Equivalent Test Circuit

BAV23CLT1G, BAV23CLT3G

PACKAGE DIMENSIONS

SOT-23 (TO-236)

CASE 318-08

ISSUE AP

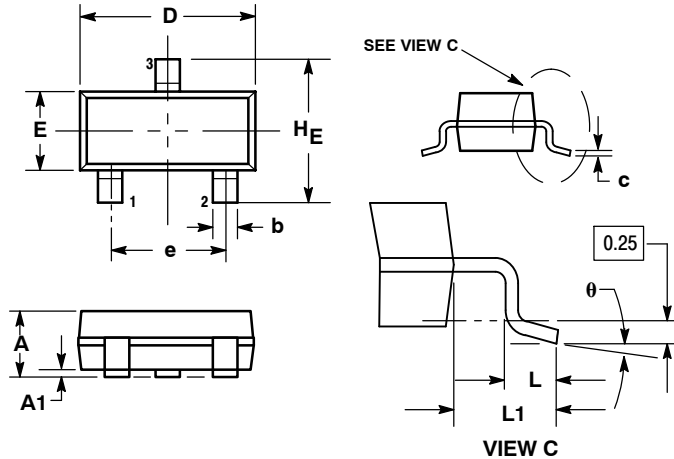

NOTES:

1. DIMENSIONING AND TOLERANCING PER ANSI Y14.5M, 1982.
2. CONTROLLING DIMENSION: INCH.
3. MAXIMUM LEAD THICKNESS INCLUDES LEAD FINISH THICKNESS. MINIMUM LEAD THICKNESS IS THE MINIMUM THICKNESS OF BASE MATERIAL.
4. DIMENSIONS D AND E DO NOT INCLUDE MOLD FLASH, PROTRUSIONS, OR GATE BURRS.

DIM	MILLIMETERS			INCHES		
	MIN	NOM	MAX	MIN	NOM	MAX
A	0.89	1.00	1.11	0.035	0.040	0.044
A1	0.01	0.06	0.10	0.001	0.002	0.004
b	0.37	0.44	0.50	0.015	0.018	0.020
c	0.09	0.13	0.18	0.003	0.005	0.007
D	2.80	2.90	3.04	0.110	0.114	0.120
E	1.20	1.30	1.40	0.047	0.051	0.055
e	1.78	1.90	2.04	0.070	0.075	0.081
L	0.10	0.20	0.30	0.004	0.008	0.012
L1	0.35	0.54	0.69	0.014	0.021	0.029
HE	2.10	2.40	2.64	0.083	0.094	0.104
θ	0°	---	10°	0°	---	10°

STYLE 9:

1. ANODE
2. ANODE
3. CATHODE

SOLDERING FOOTPRINT

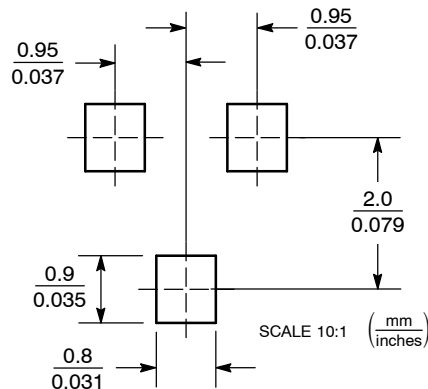

ON Semiconductor and  are registered trademarks of Semiconductor Components Industries, LLC (SCILLC). SCILLC owns the rights to a number of patents, trademarks, copyrights, trade secrets, and other intellectual property. A listing of SCILLC's product/patent coverage may be accessed at www.onsemi.com/site/pdf/Patent-Marking.pdf. SCILLC reserves the right to make changes without further notice to any products herein. SCILLC makes no warranty, representation or guarantee regarding the suitability of its products for any particular purpose, nor does SCILLC assume any liability arising out of the application or use of any product or circuit, and specifically disclaims any and all liability, including without limitation special, consequential or incidental damages. "Typical" parameters which may be provided in SCILLC data sheets and/or specifications can and do vary in different applications and actual performance may vary over time. All operating parameters, including "Typicals" must be validated for each customer application by customer's technical experts. SCILLC does not convey any license under its patent rights nor the rights of others. SCILLC products are not designed, intended, or authorized for use as components in systems intended for surgical implant into the body, or other applications intended to support or sustain life, or for any other application in which the failure of the SCILLC product could create a situation where personal injury or death may occur. Should Buyer purchase or use SCILLC products for any such unintended or unauthorized application, Buyer shall indemnify and hold SCILLC and its officers, employees, subsidiaries, affiliates, and distributors harmless against all claims, costs, damages, and expenses, and reasonable attorney fees arising out of, directly or indirectly, any claim of personal injury or death associated with such unintended or unauthorized use, even if such claim alleges that SCILLC was negligent regarding the design or manufacture of the part. SCILLC is an Equal Opportunity/Affirmative Action Employer. This literature is subject to all applicable copyright laws and is not for resale in any manner.

PUBLICATION ORDERING INFORMATION

LITERATURE FULFILLMENT:
Literature Distribution Center for ON Semiconductor
P.O. Box 5163, Denver, Colorado 80217 USA
Phone: 303-675-2175 or 800-344-3860 Toll Free USA/Canada
Fax: 303-675-2176 or 800-344-3867 Toll Free USA/Canada
Email: orderlit@onsemi.com

N. American Technical Support: 800-282-9855 Toll Free
USA/Canada
Europe, Middle East and Africa Technical Support:
Phone: 421 33 790 2910
Japan Customer Focus Center
Phone: 81-3-5817-1050

ON Semiconductor Website: www.onsemi.com
Order Literature: <http://www.onsemi.com/orderlit>

For additional information, please contact your local Sales Representative

Данный компонент на территории Российской Федерации

Вы можете приобрести в компании MosChip.

Для оперативного оформления запроса Вам необходимо перейти по данной ссылке:

<http://moschip.ru/get-element>

Вы можете разместить у нас заказ для любого Вашего проекта, будь то серийное производство или разработка единичного прибора.

В нашем ассортименте представлены ведущие мировые производители активных и пассивных электронных компонентов.

Нашей специализацией является поставка электронной компонентной базы двойного назначения, продукции таких производителей как XILINX, Intel (ex.ALTERA), Vicor, Microchip, Texas Instruments, Analog Devices, Mini-Circuits, Amphenol, Glenair.

Сотрудничество с глобальными дистрибьюторами электронных компонентов, предоставляет возможность заказывать и получать с международных складов практически любой перечень компонентов в оптимальные для Вас сроки.

На всех этапах разработки и производства наши партнеры могут получить квалифицированную поддержку опытных инженеров.

Система менеджмента качества компании отвечает требованиям в соответствии с ГОСТ Р ИСО 9001, ГОСТ РВ 0015-002 и ЭС РД 009

Офис по работе с юридическими лицами:

105318, г.Москва, ул.Щербаковская д.3, офис 1107, 1118, ДЦ «Щербаковский»

Телефон: +7 495 668-12-70 (многоканальный)

Факс: +7 495 668-12-70 (доб.304)

E-mail: info@moschip.ru

Skype отдела продаж:

moschip.ru

moschip.ru_4

moschip.ru_6

moschip.ru_9