

## General purpose Chassis and PCB mount

A series of compact, high performance, low leakage PCB and chassis mount suppression filters - with multiple combinations of enclosure size, current ratings and termination styles. This range offers flexibility and economy. Typical applications include industrial measuring equipment, consumer electronics and low power SMPS.

- Current ratings from 0.5A to 10A
- Compact PCB or chassis mount footprint
- Low profile variants (FAH)
- PCB or fast-on terminations
- Medical versions available



## Mechanical Specifications

Manufacture: plastic case sealed with self-extinguishing resin.

Connections: for PCB mounting (FA-AV) or with faston 2.8x0.5mm (FA-AA FA-DA)

## Electrical Specifications

Rated voltage ( $V_R$ ): max 250V, 50/60Hz

Rated current ( $I_R$ ): referred to room temperature = 40°C

Leakage current ( $I_L$ ): at 220V, 50Hz, max value

Voltage test (2 s.): line to ground 3000Vdc or 1800Vac  
line to line 1700Vdc

Climatic category: HPF (25/085/21);  
Temperature range: -25°C to +85°C

## Filter Range

Code	$I_R$ (A)	L (mH)	Cx ( $\mu$ F)	Cy (pF)	$I_L$ (mA)	R (M $\Omega$ )	Circ Diag
FAH -- 3100ZA	0.5	2x40	0.1	2x2500	2x0.23		A ●
FAH -- 3100ZB	1	2x10	0.1	2x2500	2x0.23		A ●
FAH -- 3100ZC	1.6	2x6	0.1	2x2500	2x0.23		A ●
FAH -- 3100ZD	2.5	2x2	0.1	2x2500	2x0.23		A ●
FAH -- 3100ZE	4	2x1	0.1	2x2500	2x0.23		A ●
FAH -- 3100ZF	6.5	2x1	0.1	2x2500	2x0.23		A ●
▲ FAH -- 3100ZG	5	2x2	0.1	2x2500	2x0.23		A ●
▲ FAH -- 3100ZK	0.5	2x40	0.1	2x4700	2x0.43		A ●
▲ FAH -- 3100ZL	1	2x10	0.1	2x4700	2x0.43		A ●
▲ FAH -- 3100ZM	1.6	2x6	0.1	2x4700	2x0.43		A ●
▲ FAH -- 3100ZN	2.5	2x2	0.1	2x4700	2x0.43		A ●
▲ FAH -- 3100ZP	6.5	2x1	0.1	2x4700	2x0.43		A ●
FAH -- 3200ZA	0.5	2x40	2x0.1		2x0.02		E
FAH -- 3200ZB	1	2x10	2x0.1		2x0.02		E
FAH -- 3200ZC	1.6	2x6	2x0.1		2x0.02		E
FAH -- 3200ZD	2.5	2x2	2x0.1		2x0.02		E
FAH -- 3200ZE	4	2x1	2x0.1		2x0.02		E
FAH -- 3200ZF	6.5	2x1	2x0.1		2x0.02		E
■ FAA -- 3100ZA	10	2x1	0.1	2x2500	2x0.23	1	A
▲ FAA -- 3100ZB	1	2x10	0.1	2x2500	2x0.23		A
▲ FAA -- 3220ZB	0.5	2x40	0.22	2x2200	2x0.20	1.5	B
▲ FAA -- 3220ZC	6.5	2x1	0.22	2x2500	2x0.23	1	A
▲ FAA -- 3330ZA	0.5	2x40	0.33	2x4700	2x0.43	1	C
▲ FAA -- 3680ZA	0.5	2x40	0.68	2x4700	2x0.43	0.47	C

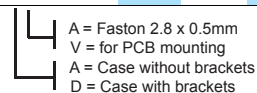

▲ No approvals. ● Also available in circuit B on request, no approvals. ■ VDE approved only.

\* other variants on request

## Dimensions (mm) and connections

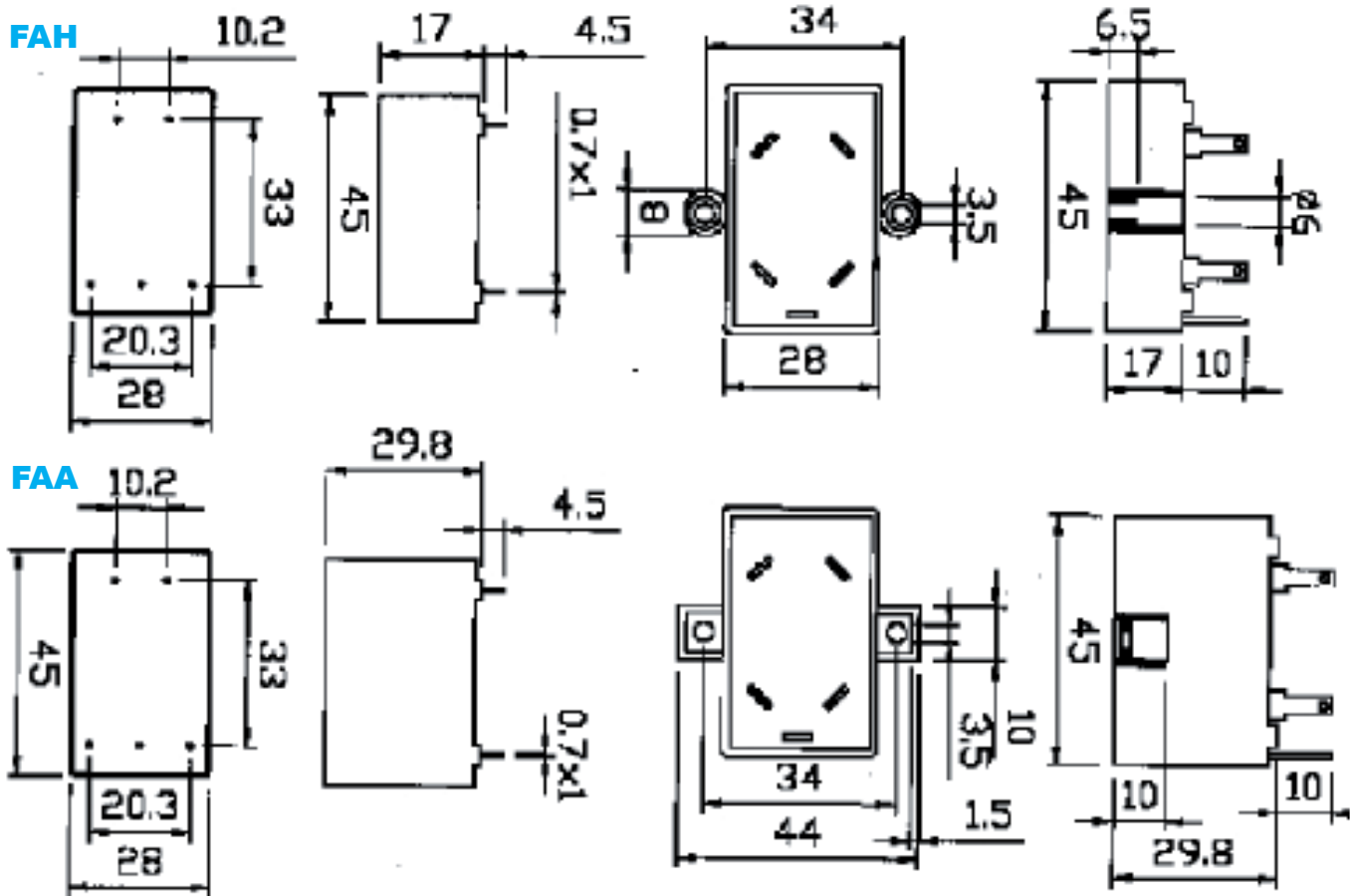

## Circuit diagram

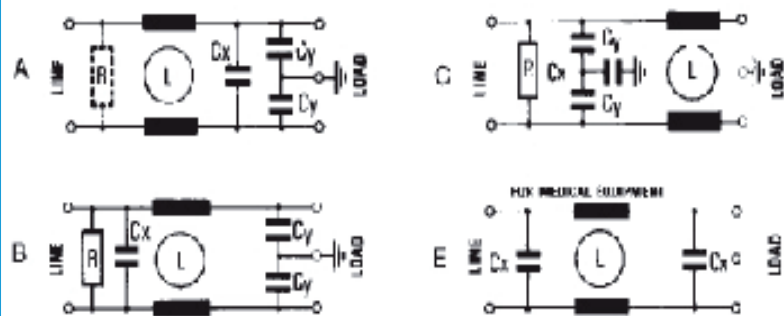

Insertion loss (typical): — Asymmetrical (line to ground) - - - Symmetrical (line to line)

## FAH

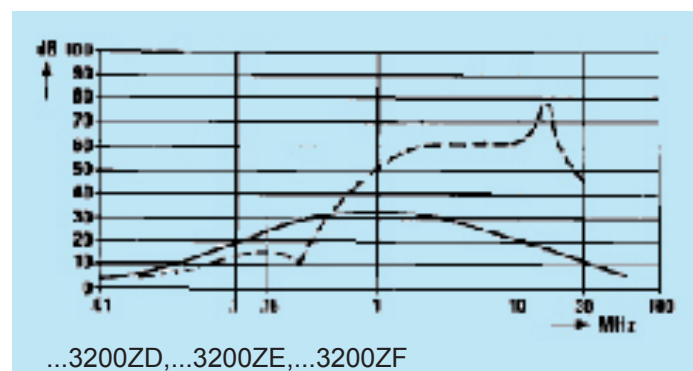
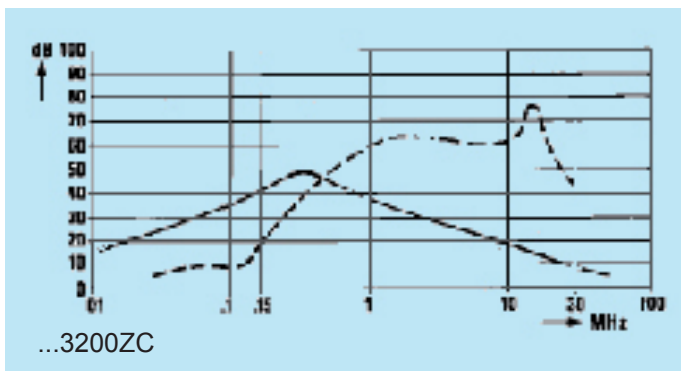
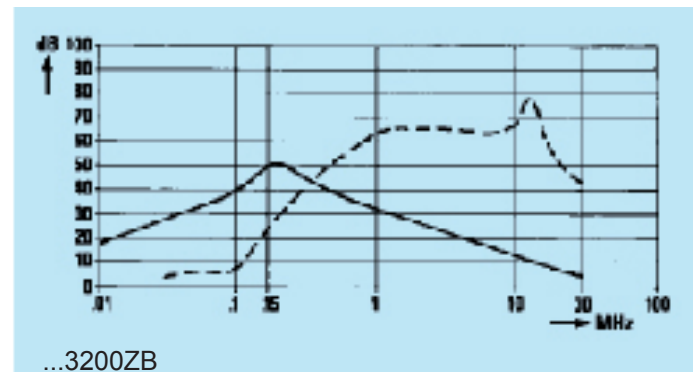
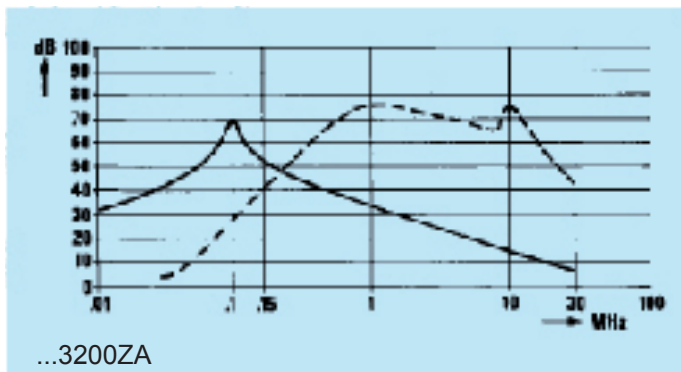
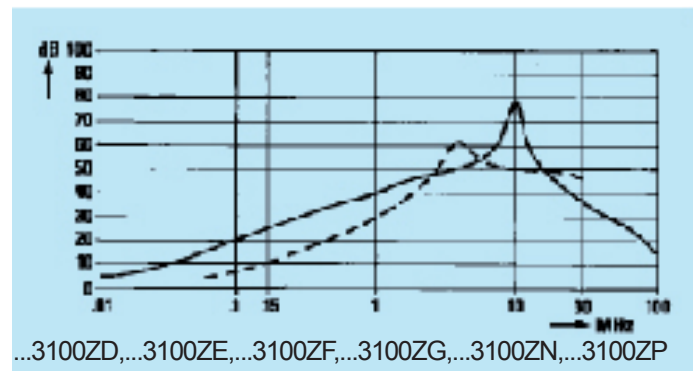
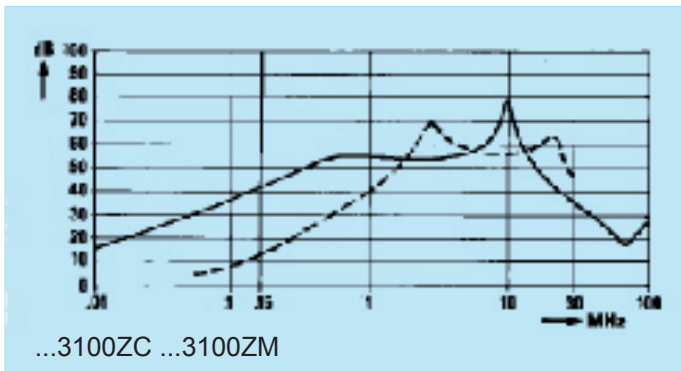
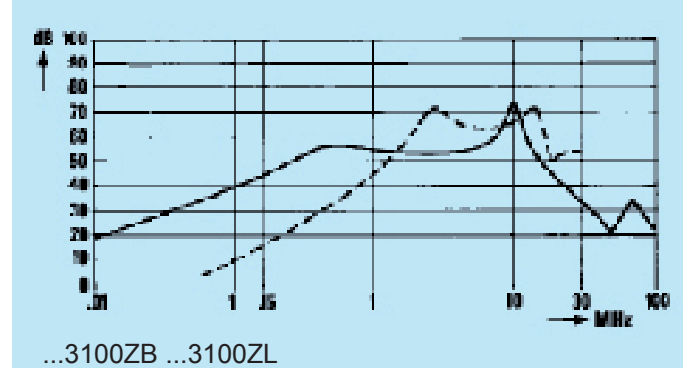
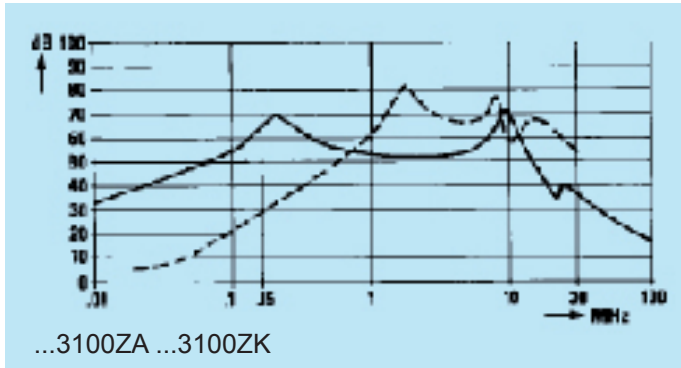

Insertion loss (typical): — Asymmetrical (line to ground) - - - Symmetrical (line to line)

## FAA

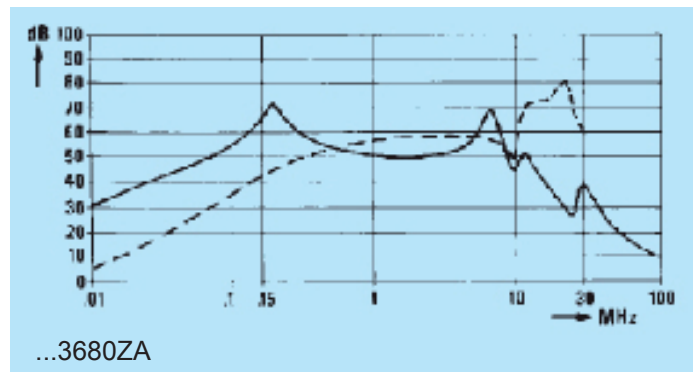
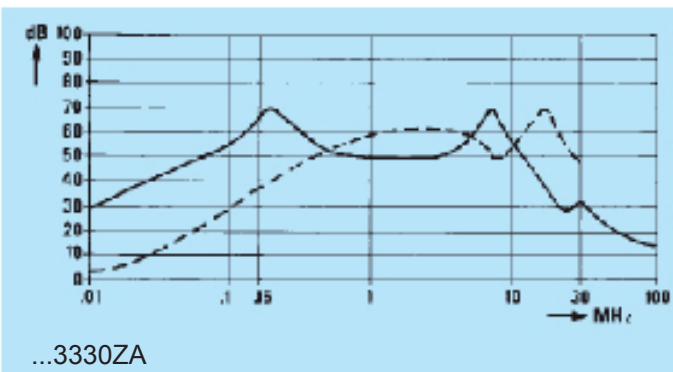
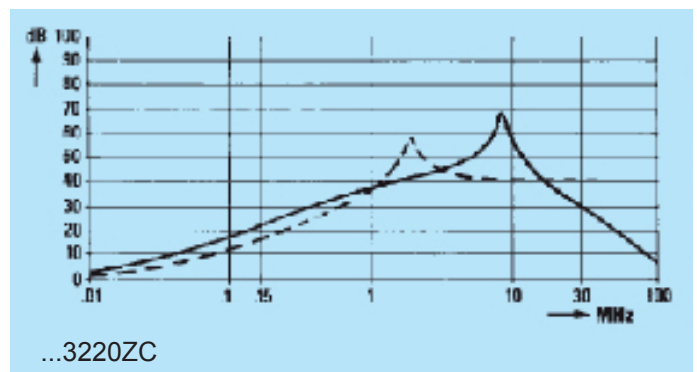
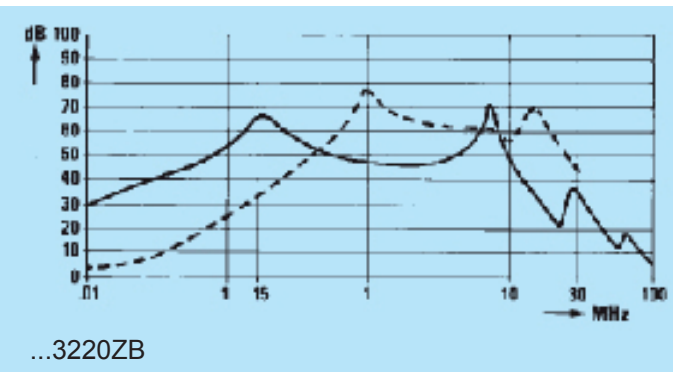
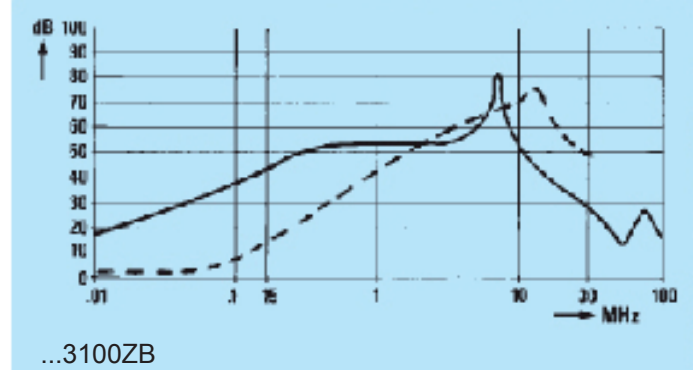
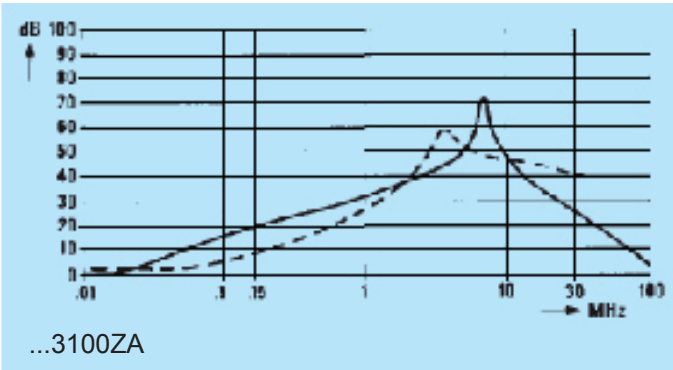

## High performance

This range provides a high level of performance within compact metal enclosures for printed circuit board configurations.

Specifically designed to protect against symmetric, asymmetric, periodic and pulse shaped RFI.

Ideal for use with office equipment, telecom products, computers and industrial applications.

- Current ratings from 3A to 16A
- PCM mount termination
- High RFI attenuation
- Single or two stage circuit designs
- Medical versions available

## Mechanical Specifications

Manufacture: metal case sealed with self-extinguishing resin.  
 Connections: for PCB mounting; ground terminal connected to case.

## Filter Range

Code	I <sub>R</sub> (A)	L (mH)	L <sub>1</sub> (mH)	Cx <sub>1</sub> (μF)	Cx <sub>2</sub> (μF)	Cy1 (pF)	Cy2 (pF)	I <sub>L</sub> (mA)	R (MΩ)	Circ diag
FAMAV3600ZC010	16	2x1			0.6	2x2500		2x0.23	1	A
▲ FAMAV3600ZI010	16	2x1			0.6	2x6800		2x0.62	1	A
FAMAV3940ZA	3.3	2x13		0.47	0.47	2x6800		2x0.62	0.33	B
FAMAV3940ZB001	3.3	2x13	2x1	0.47	0.47	2x6800	2x1000	2x.072	0.68	C

▲ UL approval only  
 \* other variants on request

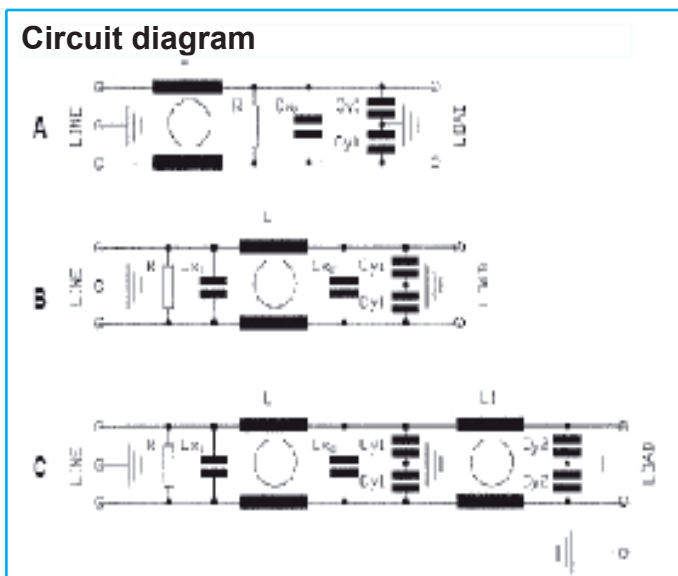

## Electrical Specifications

Rated voltage (V<sub>R</sub>): max 250V, 50/60Hz  
 Rated current (I<sub>R</sub>): referred to room temperature = 40°C  
 Leakage current (I<sub>L</sub>): at 220V, 50Hz, max value  
 Voltage test (2 s.): line to ground 3000Vdc or 1800Vac  
 line to line 1700Vdc  
 Climatic category: HPF (25/085/21);  
 Temperature range: -25°C to +85°C

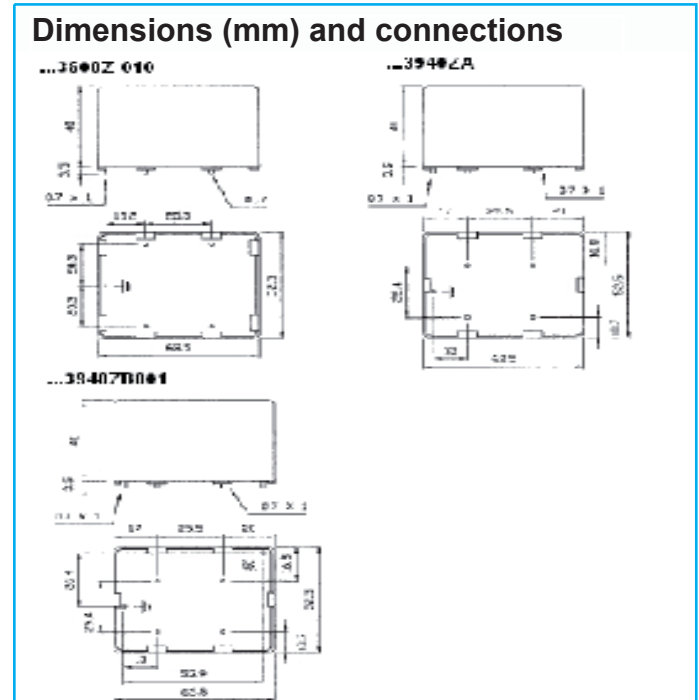

Approvals



in progress



1283



22.2 N°8



Insertion loss (typical): — Asymmetrical (line to ground) - - - Symmetrical (line to line)

## FAMAV

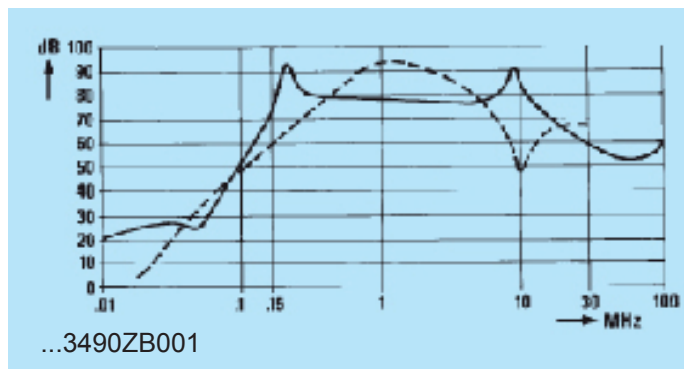
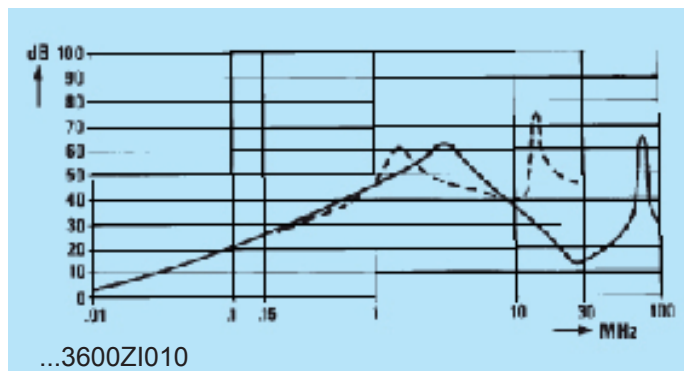
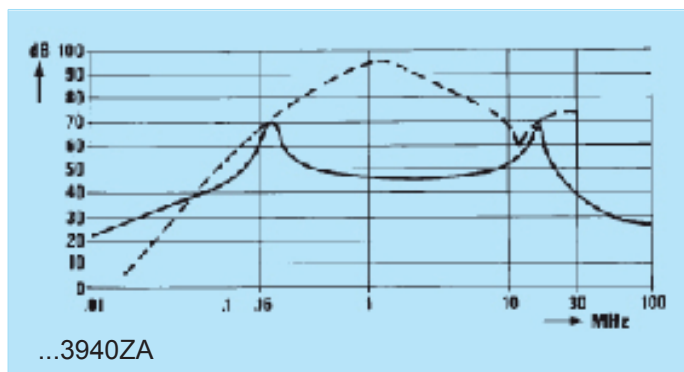
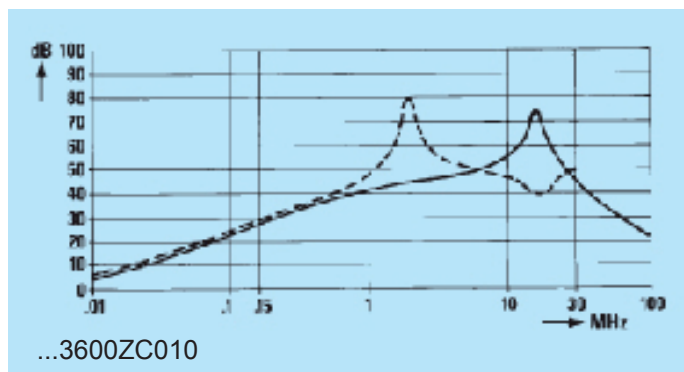

## Данный компонент на территории Российской Федерации

### Вы можете приобрести в компании MosChip.

Для оперативного оформления запроса Вам необходимо перейти по данной ссылке:

<http://moschip.ru/get-element>

Вы можете разместить у нас заказ для любого Вашего проекта, будь то серийное производство или разработка единичного прибора.

В нашем ассортименте представлены ведущие мировые производители активных и пассивных электронных компонентов.

Нашей специализацией является поставка электронной компонентной базы двойного назначения, продукции таких производителей как XILINX, Intel (ex.ALTERA), Vicor, Microchip, Texas Instruments, Analog Devices, Mini-Circuits, Amphenol, Glenair.

Сотрудничество с глобальными дистрибьюторами электронных компонентов, предоставляет возможность заказывать и получать с международных складов практически любой перечень компонентов в оптимальные для Вас сроки.

На всех этапах разработки и производства наши партнеры могут получить квалифицированную поддержку опытных инженеров.

Система менеджмента качества компании отвечает требованиям в соответствии с ГОСТ Р ИСО 9001, ГОСТ РВ 0015-002 и ЭС РД 009

### Офис по работе с юридическими лицами:

105318, г.Москва, ул.Щербаковская д.3, офис 1107, 1118, ДЦ «Щербаковский»

Телефон: +7 495 668-12-70 (многоканальный)

Факс: +7 495 668-12-70 (доб.304)

E-mail: [info@moschip.ru](mailto:info@moschip.ru)

Skype отдела продаж:

moschip.ru

moschip.ru\_4

moschip.ru\_6

moschip.ru\_9