

Buzzer Unit Series with Cylindrical 22-mm × 16-dia. Body



- Lineup includes standard-volume models (80 phons, constant) and high-volume models (70 to 95 phons, variable). Intermittent or continuous sound can be selected.



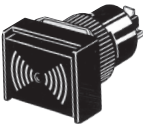

 Refer to "Safety Precautions for All Pushbutton Switches" and "Safety Precautions" on page 5.

List of Models

Buzzer

Appearance	Model
Rectangular standard-volume model 	M2BJ-B
Rectangular high-volume model 	M2BJ-BH

Ordering Information

Appearance							
		Standard sound				High sound *1	
w/jumper direction A *2	Intermittent	Intermittent (short)	Intermittent (high-pitched)	Intermittent (short, high-pitched)	Intermittent (high-pitched)	Intermittent (short)	
	w/jumper direction B *2 (w/o jumper)	Continuous	Intermittent (long)	Continuous (high-pitched)	Intermittent (long, high-pitched)	Continuous	Intermittent (long)
Supply voltage							
6 VAC/VDC	Model	M2BJ-B06	M2BJ-B06A	M2BJ-B06B	M2BJ-B06C	M2BJ-BH06D	M2BJ-BH06E
12 to 24 VAC/VDC		M2BJ-B24	M2BJ-B24A	M2BJ-B24B	M2BJ-B24C	M2BJ-BH24D	M2BJ-BH24E
12 to 24 VDC		M2BJ-B24-D	---	M2BJ-B24B-D	---	M2BJ-BH24D-D	M2BJ-BH24E-D

*1. High-sound models incorporate an LED, which lights when the Buzzer sounds.

*2. Refer to "Short-circuiting Jumper (M2BJ-BTH)" on page 5 for the insert direction of the jumper.

External Signal Selection Model (M2BJ-BH24D-DA)

- An external signal selection model is also available. With this model, it is possible to switch between continuous and intermittent sound using an external signal instead of the jumper.

M2BJ-BH24D-DA

- SW:
 - When A direction is ON (terminals 1, 2 ON): intermittent sound
 - When B direction is ON (terminals 2, 3 ON): continuous sound

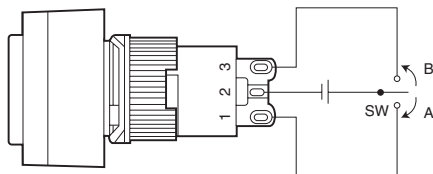

- Note: 1. Ensure that voltage is not applied simultaneously between terminals 1, 2, and 3.
 2. Check the power supply polarity. Connecting with the polarity reversed may result in damage.

Specifications

Buzzer

Item	Model	Standard-sound Models			
		M2BJ-B06	M2BJ-B06A	M2BJ-B06B	M2BJ-B06C
Operating voltage		6 VAC/VDC			
Sound pressure (at 0.1 m and rated voltage)		Continuous sound: 80 dB (phons) min.			
Driving frequency		2±0.5 kHz		4±0.5 kHz	
Intervals		190 times/minute±10%	*2 Long:55 times/minute±10% *1 Short:700 times/minute±10%	190 times/minute±10%	*4 Long:55 times/minute±10% *3 Short:700 times/minute±10%
Current consumption	DC	7 mA max.		20 mA max.	
	AC	20 mA max.			
Inrush current		1 A max.			
Life expectancy		1,000 hours min.			
Insulation resistance		100 MΩ min. (between ground and current-carrying parts)			
Dielectric strength		1,000 VAC for 1 minute (between grounds)			
Ambient operating temperature		-10°C to 55°C (no icing or condensation)			
Ambient operating humidity		35% to 85%RH			
Ambient storage temperature		-25°C to 65°C (no icing or condensation)			
Degree of protection		IP 40			
Weight		Approx. 9 g			

Item	Model	Standard-sound Models					
		M2BJ-B24	M2BJ-B24A	M2BJ-B24B	M2BJ-B24C	M2BJ-B24-D	M2BJ-B24B-D
Operating voltage		12 to 24 VAC/VDC			12 to 24 VDC		
Sound pressure (at 0.1 m and rated voltage)		Continuous sound: 80 dB (phons) min.					
Driving frequency		2±0.5 kHz		4±0.5 kHz		2±0.5 kHz	4±0.5 kHz
Intervals		190 times/minute±10%	*2 Long:55 times/minute±10% *1 Short:700 times/minute±10%	190 times/minute±10%	*4 Long:55 times/minute±10% *3 Short:700 times/minute±10%	190 times/minute±10%	
Current consumption	DC	7 mA max.		20 mA max.		7 mA max.	20 mA max.
	AC	20 mA			---		
Inrush current		1 A max.			---		
Life expectancy		1,000 hours min.					
Insulation resistance		100 MΩ min. (between ground and current-carrying parts)					
Dielectric strength		1,000 VAC for 1 minute (between grounds)					
Ambient operating temperature		-10°C to 55°C (no icing or condensation)					
Ambient operating humidity		35% to 85%RH					
Ambient storage temperature		-25°C to 65°C (no icing or condensation)					
Degree of protection		IP 40					
Weight		Approx. 9 g					

Item	Model	High-sound Models					
		M2BJ-BH06D	M2BJ-BH24D	M2BJ-BH06E	M2BJ-BH24E	M2BJ-BH24D-D	M2BJ-BH24E-D
Operating voltage		6 VAC/VDC	12 to 24 VAC/VDC	6 VAC/VDC	12 to 24 VAC/VDC	12 to 24 VDC	
Sound pressure (The sound pressure can be adjusted. The figure for sound pressure given above is for measurement at a distance of 0.1 m at the rated voltage.)		70 to 95 dB (phons)					
Driving frequency		3±0.5 kHz					
Intervals		Approx. 190 times/min.		*6 Long: Approx. 55 times/min. *5 Short: Approx. 700 times/min.		Approx. 190 times/min.	*6 Long: Approx. 55 times/min. *5 Short: Approx. 700 times/min.
Current consumption	DC	50 mA max.					
	AC	100 mA max.			---		
Inrush current		1 A max.			---		
Life expectancy		1,000 hours min.					
Insulation resistance		100 MΩ min. (between ground and current-carrying parts)					
Dielectric strength		1,000 VAC for 1 minute (between grounds)					
Ambient operating temperature		-10°C to 55°C (no icing or condensation)					
Ambient operating humidity		35% to 85%RH					
Ambient storage temperature		-25°C to 65°C (no icing or condensation)					
Degree of protection		IP 40					
Weight		Approx. 12 g					

*Tone

*1	Standard volume	High volume	Bird cry
*2			Telephone busy signal
*3		Continuous (high pitch)	Short beeps
*4			Long beeps
*5	High volume	Intermittent	Alternating high-low pitch
*6			Long beeps

Dimensions

Standard-sound Models M2BJ-B

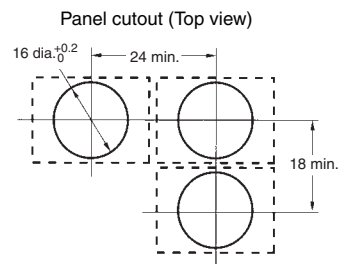
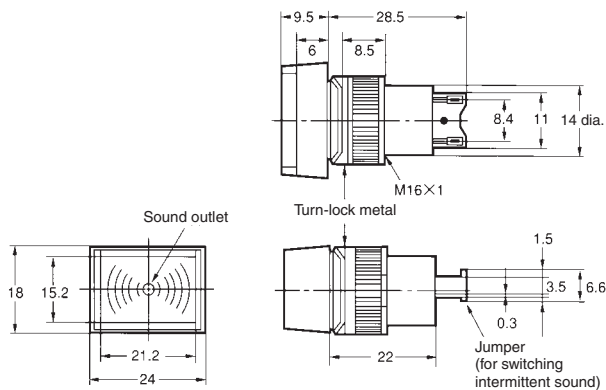
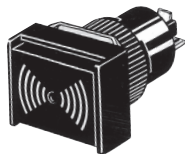

High-sound Models M2BJ-BH

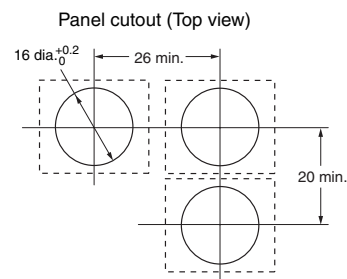
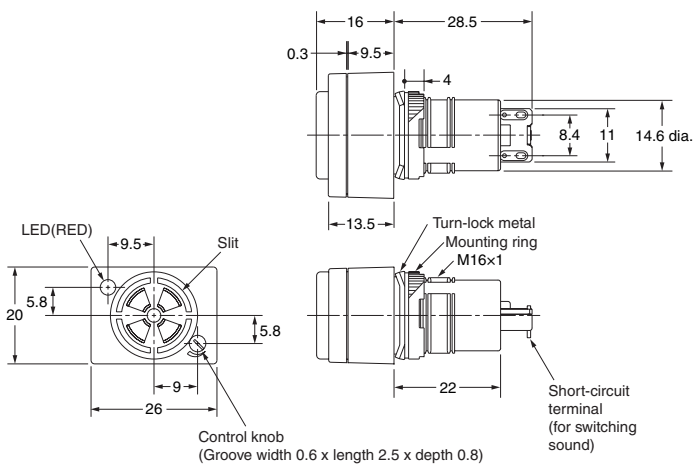

Note: The LED lights while the sound is produced.
For intermittent sound, the LED flashes
synchronized with the sound.

Contact Form

All Models
(Standard and High-sound Models)

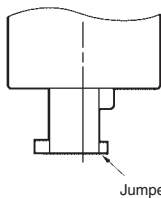

Jumper

Terminal Hole Dimensions

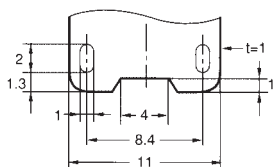

Terminal Arrangement
(Bottom view)

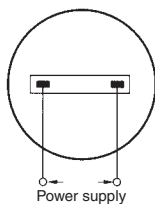

Power supply

Note: There is no +/- polarity.

Safety Precautions

Refer to *Safety Precautions for All Pushbutton Switches*.

Precautions for Correct Use

Application Precautions

- When power is supplied, there is an inrush current of up to 1 A. Confirm that this will not adversely affect operation or damage any devices before using the M2BJ in application. There is no inrush current with DC-only models (M2BJ-□□□-D).
- With models that can use both AC and DC, residual energy in the internal capacitor may cause residual sound.

Wiring

- Perform soldering promptly and correctly at a temperature of 350°C within 3 seconds. Wait for one minute after soldering before exerting any external force on the solder.
- If flux is required, use non-corrosive rosin liquid. Ensure that the flux does not penetrate the inside of the case.
- In order to improve the reliability of the soldering and to prevent pattern burnout, loop the wire through the terminal hole before soldering.
- In order to fit the terminal holes, use lead wires with a nominal cross sectional area of 0.25 mm² max.

Operating Environment

- Do not use the Buzzer in environments where foreign substances may enter the sound outlet. Otherwise, the Buzzer may not sound.

Volume Adjustment Mechanism (M2BJ-BH Only)

- Adjust the volume by turning the control knob on the face of the Buzzer using a screwdriver. Turn to the right to increase the volume and turn to the left to decrease the volume.
- Turn the control knob with a torque of 0.98 to 2.94 mN·m.

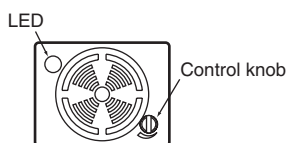

Short-circuiting Jumper (M2BJ-BTH)

- The Buzzer sounds continuously or intermittently depending on how the short-circuiting bracket is attached to the case guide. When the bracket is attached with the triangle on it facing direction A (PC board side), the Buzzer sounds intermittently.
- To produce continuous sounds, attach the bracket to the case guide so that the triangle on the bracket faces direction B.
- The bracket is set in direction A when ship the product. If the bracket becomes lost, contact your OMRON representative. The model number to order is M2BJ-BTH.

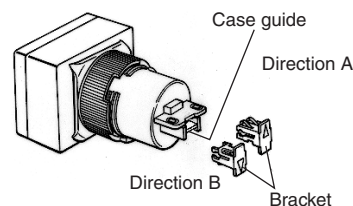

Short-circuit Bracket Mounting Location

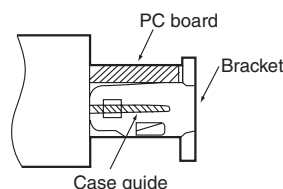

Read and Understand This Catalog

Please read and understand this catalog before purchasing the products. Please consult your OMRON representative if you have any questions or comments.

Warranty and Limitations of Liability

WARRANTY

OMRON's exclusive warranty is that the products are free from defects in materials and workmanship for a period of one year (or other period if specified) from date of sale by OMRON.

OMRON MAKES NO WARRANTY OR REPRESENTATION, EXPRESS OR IMPLIED, REGARDING NON-INFRINGEMENT, MERCHANTABILITY, OR FITNESS FOR PARTICULAR PURPOSE OF THE PRODUCTS. ANY BUYER OR USER ACKNOWLEDGES THAT THE BUYER OR USER ALONE HAS DETERMINED THAT THE PRODUCTS WILL SUITABLY MEET THE REQUIREMENTS OF THEIR INTENDED USE. OMRON DISCLAIMS ALL OTHER WARRANTIES, EXPRESS OR IMPLIED.

LIMITATIONS OF LIABILITY

OMRON SHALL NOT BE RESPONSIBLE FOR SPECIAL, INDIRECT, OR CONSEQUENTIAL DAMAGES, LOSS OF PROFITS OR COMMERCIAL LOSS IN ANY WAY CONNECTED WITH THE PRODUCTS, WHETHER SUCH CLAIM IS BASED ON CONTRACT, WARRANTY, NEGLIGENCE, OR STRICT LIABILITY.

In no event shall the responsibility of OMRON for any act exceed the individual price of the product on which liability is asserted.

IN NO EVENT SHALL OMRON BE RESPONSIBLE FOR WARRANTY, REPAIR, OR OTHER CLAIMS REGARDING THE PRODUCTS UNLESS OMRON'S ANALYSIS CONFIRMS THAT THE PRODUCTS WERE PROPERLY HANDLED, STORED, INSTALLED, AND MAINTAINED AND NOT SUBJECT TO CONTAMINATION, ABUSE, MISUSE, OR INAPPROPRIATE MODIFICATION OR REPAIR.

Application Considerations

SUITABILITY FOR USE

OMRON shall not be responsible for conformity with any standards, codes, or regulations that apply to the combination of products in the customer's application or use of the products.

At the customer's request, OMRON will provide applicable third party certification documents identifying ratings and limitations of use that apply to the products. This information by itself is not sufficient for a complete determination of the suitability of the products in combination with the end product, machine, system, or other application or use.

The following are some examples of applications for which particular attention must be given. This is not intended to be an exhaustive list of all possible uses of the products, nor is it intended to imply that the uses listed may be suitable for the products:

- Outdoor use, uses involving potential chemical contamination or electrical interference, or conditions or uses not described in this catalog.
- Nuclear energy control systems, combustion systems, railroad systems, aviation systems, medical equipment, amusement machines, vehicles, safety equipment, and installations subject to separate industry or government regulations.
- Systems, machines, and equipment that could present a risk to life or property.

Please know and observe all prohibitions of use applicable to the products.

NEVER USE THE PRODUCTS FOR AN APPLICATION INVOLVING SERIOUS RISK TO LIFE OR PROPERTY WITHOUT ENSURING THAT THE SYSTEM AS A WHOLE HAS BEEN DESIGNED TO ADDRESS THE RISKS, AND THAT THE OMRON PRODUCTS ARE PROPERLY RATED AND INSTALLED FOR THE INTENDED USE WITHIN THE OVERALL EQUIPMENT OR SYSTEM.

PROGRAMMABLE PRODUCTS

OMRON shall not be responsible for the user's programming of a programmable product, or any consequence thereof.

Disclaimers

CHANGE IN SPECIFICATIONS

Product specifications and accessories may be changed at any time based on improvements and other reasons.

It is our practice to change model numbers when published ratings or features are changed, or when significant construction changes are made. However, some specifications of the products may be changed without any notice. When in doubt, special model numbers may be assigned to fix or establish key specifications for your application on your request. Please consult with your OMRON representative at any time to confirm actual specifications of purchased products.

DIMENSIONS AND WEIGHTS

Dimensions and weights are nominal and are not to be used for manufacturing purposes, even when tolerances are shown.

PERFORMANCE DATA

Performance data given in this catalog is provided as a guide for the user in determining suitability and does not constitute a warranty. It may represent the result of OMRON's test conditions, and the users must correlate it to actual application requirements. Actual performance is subject to the OMRON Warranty and Limitations of Liability.

ERRORS AND OMISSIONS

The information in this document has been carefully checked and is believed to be accurate; however, no responsibility is assumed for clerical, typographical, or proofreading errors, or omissions.

2008.12

In the interest of product improvement, specifications are subject to change without notice.

OMRON Corporation
Industrial Automation Company

<http://www.ia.omron.com/>

(c)Copyright OMRON Corporation 2008 All Right Reserved.

Данный компонент на территории Российской Федерации

Вы можете приобрести в компании MosChip.

Для оперативного оформления запроса Вам необходимо перейти по данной ссылке:

<http://moschip.ru/get-element>

Вы можете разместить у нас заказ для любого Вашего проекта, будь то серийное производство или разработка единичного прибора.

В нашем ассортименте представлены ведущие мировые производители активных и пассивных электронных компонентов.

Нашей специализацией является поставка электронной компонентной базы двойного назначения, продукции таких производителей как XILINX, Intel (ex.ALTERA), Vicor, Microchip, Texas Instruments, Analog Devices, Mini-Circuits, Amphenol, Glenair.

Сотрудничество с глобальными дистрибьюторами электронных компонентов, предоставляет возможность заказывать и получать с международных складов практически любой перечень компонентов в оптимальные для Вас сроки.

На всех этапах разработки и производства наши партнеры могут получить квалифицированную поддержку опытных инженеров.

Система менеджмента качества компании отвечает требованиям в соответствии с ГОСТ Р ИСО 9001, ГОСТ РВ 0015-002 и ЭС РД 009

Офис по работе с юридическими лицами:

105318, г.Москва, ул.Щербаковская д.3, офис 1107, 1118, ДЦ «Щербаковский»

Телефон: +7 495 668-12-70 (многоканальный)

Факс: +7 495 668-12-70 (доб.304)

E-mail: info@moschip.ru

Skype отдела продаж:

moschip.ru

moschip.ru_4

moschip.ru_6

moschip.ru_9