



Actual size



PRODUCT OVERVIEW

Murata Power Solutions' ACM20 series AC power meters display the most critical measurements in mains-powered equipment: voltage, amperage, active power (watts), and power factor. A front panel selector-switch provides two modes of operation: a fixed reading of any of the four parameters, or a continuous cycling through all four measurements. An optional model displays line frequency with 0.1Hz resolution. All ACM20 multi-function power meters include built-in current transformers—no other user-supplied components are required.

ACM20 series AC power meters are available in a choice of three input ranges: 0-10A (with 0.001A resolution, 999.9 watts max.); 0-32A (with 0.01A resolution, 9999 watts max.); and 0-100A (0.1A resolution, 26.4kW max.). An 85-264Vac (47-63Hz) operating supply range makes these power meters perfect for worldwide power monitoring applications. And, unlike conventional, average-responding products, ACM20 power meters can accurately display the real power and true-rms current values of triangle waves, square waves, and other irregularly shaped waveforms, with a typical accuracy of $\pm 1\%$ of full scale.

Their large (0.36"/9.2mm), bright red LED display makes ACM20 AC power meters easily readable from as far as 15 feet (5 meters). All units are packaged in a one-piece, vibration resistant, polycarbonate housing that can be installed in vertical '0U' and '1U' rack spaces. Their miniature size is perfect for UPS power sources, power strips, laboratory instrumentation, alternative energy applications, and any other products that require precise monitoring of AC power.

FEATURES

- Displays AC Volts, Amps, Watts, and Power Factor or Hertz
- Two display modes: continuous auto cycling or fixed
- Universal 85-264Vac (47-63Hz) operating range (Measurement Category II)
- Built-in current transformers simplify installation; choice of 10A, 32A, or 100A ranges
- Ideal for power distribution units (PDUs) and power strips
- True-rms readings of complex voltage and current waveforms
- Low-power consumption: less than ¼watt from 120Vac
- One-piece polycarbonate housing fits '0U' & '1U' racks
- Surface mount design occupies minimal panel space
- Bright red LED-display with four annunciators
- Optional Frequency reading models (0.1Hz resolution)
- Approvals to UL/CSA/IEC/EN 61010-1

SIMPLIFIED SCHEMATIC DIAGRAM

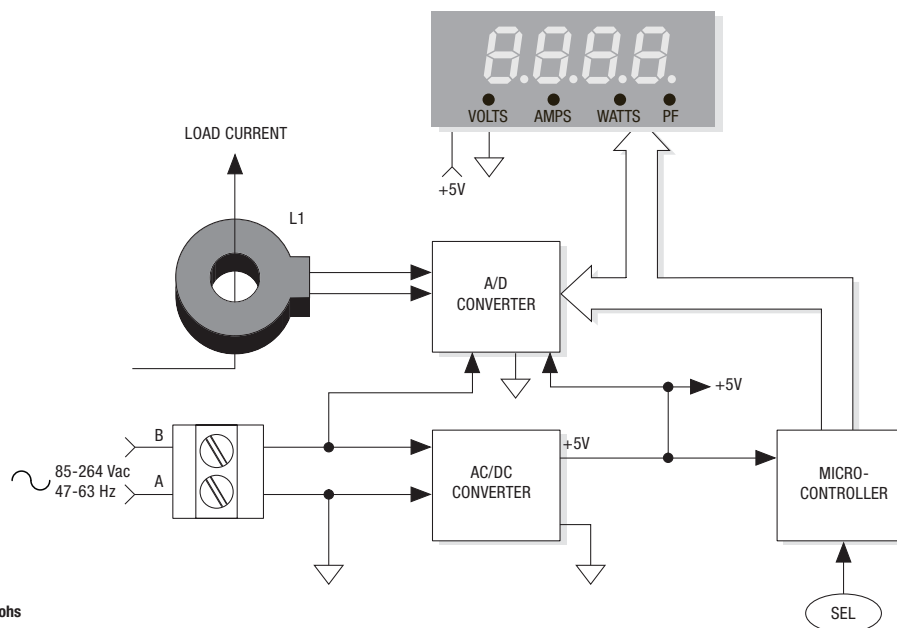

Performance/Functional Specifications

Typical at TA=+ 25°C, 220Vac @ 50Hz, unless otherwise noted

Measurement Limits	Min.	Typ.	Max.	Units
AC Voltage	85.0	-	264.0	Volts
AC Current, 10A models ①	0.00	-	9.999	Amperes
AC Current, 32A models ①	0.00	-	32.00	Amperes
AC Current, 100A models ①	0.0	-	100.0	Amperes
Active Power: 10A models	0	-	999.9	Watts
32A models	0	-	9999	Watts
100A models	0	-	26.4	kW
Frequency	47.0	-	63.0	Hz
Power Factor	.00	1.00	-	-
Overcurrent Rating ②	1.5 x rated full-scale current			
Performance				
Sampling Rate	1 sample / sec			
Voltage Accuracy ③		±1%	±2%	
Current Accuracy ③		±2%	±3%	
Power Accuracy ③		±2%	±3%	
Frequency Accuracy ③		±0.1		Hz
Power Factor Accuracy		±3%	±5%	
Measurement Bandwidth	140Hz (Voltage), 14kHz (Current)			
Temperature Drift (0 to 60°C)	0.5 Counts/°C			
Zero-Current Reading (within 2 sec.)	0.00			Amps
Zero-Power Reading (within 2 sec.)	0			Watts
Supply Voltage (TB1) (Measurement Category II)				
All Models – 47-63 Hz	85	120	264	Vac
Supply Current ④				
Red LED Models		50	110	mA
Blue and Green LED Models		75	165	mA
Power Supply Terminal Block				
Wire Size	16-22AWG, solid or stranded			
Insulation Strip Length	6.4mm (0.250 in)			
Screw Tightening Torque	0.4Nm (3.6 lb-in)			
Rated Voltage	300Vac			
Display				
Display Type and Size	4 Digit LED, 9.14mm (0.36in) high			
Overrange Indication	Flashing '9999' Watts ⑤			
Decimal Point Selection	Automatically Set			
Physical/Environmental				
Operating Temperature	0	-	+60	°C
Storage Temperature	-40	-	+75	°C
Humidity (non-condensing)	0	-	85	%
Dimensions	See mechanical specifications			
Weight: 32A models	1.3oz (37.9g)			
100A models	1.5oz (43.5g)			
Hex Nut Tightening Torque	0.14 N-m (20 ozf-in)			

① Specified full-scale currents are those passing through the power meter's built-in current transformer's primary load-circuit.

② The overcurrent rating of 1.5 x the rated full-scale current is a continuous rating and applies to the current passing through the built in current transformer. Accuracy is guaranteed up to the rated current.

③ ACM20 Power Meters are calibrated with near full-scale 50Hz sine-wave inputs.

④ All specified maximum supply currents are steady state; larger surge currents can occur at initial application of line power.

⑤ Applies to 10A and 32A models only.

ORDERING INFORMATION

ACM20-2-AC1-R-C	10A, Red LED, Power Factor Reading
ACM20-5-AC1-R-C	32A, Red LED, Power Factor Reading
ACM20-4-AC1-R-C	100A, Red LED, Power Factor Reading
ACM20-2-AC1-R-F-C	10A, Red LED, Frequency Reading
ACM20-5-AC1-R-F-C	32A, Red LED, Frequency Reading
ACM20-4-AC1-R-F-C	100A, Red LED, Frequency Reading
ACM20-2-AC1-G-C	10A, Green LED, Power Factor Reading
ACM20-5-AC1-G-C	32A, Green LED, Power Factor Reading
ACM20-4-AC1-G-C	100A, Green LED, Power Factor Reading
ACM20-2-AC1-B-C	10A, Blue LED, Power Factor Reading
ACM20-5-AC1-B-C	32A, Blue LED, Power Factor Reading
ACM20-4-AC1-B-C	100A, Blue LED, Power Factor Reading

TECHNICAL NOTES



IMPORTANT! To ensure safe and reliable operation, ACM20 power meters must be installed and serviced by qualified technical personnel. Contact Murata Power Solutions if there is any doubt regarding their installation or operation.

- Measurement Type:** ACM20 series multifunction AC power meters employ a precision energy metering integrated circuit and a low-power microcontroller to measure and display the rms voltage and current, active (real) power, power factor (or line frequency on '-F' suffix models) of ac mains supplies from 47-63Hz. Please note, ACM20 power meters use the voltage present at their TB1 terminal block and the secondary current of their built-in current transformer L1 to calculate and then display VOLTS, AMPS, WATTS, power factor (PF), or line frequency on '-F' HERTZ models.

While the ACM20 displays the rms value of line voltage and line current, the VOLTS reading has an upper limit of 140Hz (-3db point), which means rectangular-shaped voltage waveforms, and waveforms with sharp transitions, will read lower than their true-rms value. For example, a square wave line voltage will read approximately 1-2% lower, a triangle wave will read 3% lower, and a modified sine wave will read 18% lower. The oscillograms on page seven illustrate typical ACM20 VOLTS readings when powered from four ac waveforms.

The 140Hz bandwidth limit does not apply to the WATTS reading nor to the AMPS reading. The circuitry used for these two measurements has an upper bandwidth of 14kHz. ACM20 power meters are mains operated devices designed to measure ac currents and voltages, within the specified limits previously noted. DC currents and voltages will not be measured accurately.

- Basic Operation:** Upon application of ac power to TB1, the unit will first perform a self-test routine and then continuously display ac volts with the VOLTS LED annunciator illuminated. The display will remain in the VOLTS mode as long as the front panel 'SEL' button is not touched.

After the unit powers up to normal operation in the VOLTS reading mode, momentarily (approximately one second) touching the 'SEL' button on the unit's front panel three times in succession will cycle the display to AMPS, WATTS, and end at PF (or HERTZ for '-F' models). Momentarily touching 'SEL' a fourth time will return the display back to the VOLTS reading mode.

Holding the 'SEL' button down for 3 seconds will place the unit in a continuous auto-cycling mode, and the display will repetitively scroll through all four measurements, with each measurement remaining displayed for 3 seconds.

When the continuous auto-cycling mode is initially selected, the unit will briefly display 'Auto On' before continuous cycling begins. Momentarily touching the 'SEL' button again will cause the unit to briefly display 'Auto OFF' before it returns to the fixed VOLTS reading mode.

Displaying a specific mode on power up: Units manufactured after February 2012 can be configured to automatically show any one of the four display modes upon future applications of ac power. For example, it may be desirable to configure the unit to always power up in the AMPS mode.

To set the unit to always read AMPS on power up, tap the SEL switch until the AMPS mode is displayed, and then leave the unit in this mode for at least 60 seconds. As long as the SEL switch is not pressed again during the 60 second interval, the unit will configure itself to always power up displaying the chosen mode, which is AMPS in this example.

In summary, operating the unit undisturbed in a particular display mode for 60 seconds or longer will automatically configure the unit to display that particular mode the next time ac power to the unit is cycled off and back on. This functionality also applies to the auto-cycle mode, that is, the unit can be configured to always power up in the auto-cycle (scrolling) display mode by following the instructions outlined above.

- 3. Calibration:** Due to their digital design, ACM20 power meters cannot be calibrated in the field. ACM20 power meters are factory-calibrated to meet their specified accuracies with the supplied L1 current transformer. Use of any other current transformer will produce significant errors for the Amps, Watts, and Power Factor measurements.

Contact Murata Power Solutions if additional information is required regarding calibration, setup, or any other technical issue pertaining to ACM20 power meters.

- 4. Wiring:** All power supply wiring must be rated for the voltages and currents they will carry and must comply with any code or application-mandated requirements pertaining to the user's specific installation.

- 5. Supply Fusing, and Grounding:** Wires specified in the Functional Specifications section must be used for making connections to ACM20 series power meters. No connection is required for earth/chassis ground.

ACM20 series power meters are not internally fused. Terminal block TB1 is to be used only for powering the power meter's internal circuitry; it must not be used to supply power to external loads. The supply wires feeding these power meters must be fused with a 0.5A/250V time delay/time lag fuse, in accordance with applicable regulatory codes.

Wire insulation must be stripped to within $\pm 10\%$ of the stated dimensions, and wires should be inserted into TB1 such that their insulation is not pinched by the screw terminal.

- 6. Current Transformer Polarity:** In order to perform accurate Watts and Power Factor measurements, connections to the two rear power supply inputs, TB1-A and TB1-B, and built-in current transformer L1 must have the proper polarity. That is, the load current flowing in the wire passing through L1's center hole must have the same polarity as the line voltage connected to TB1-A and TB1-B.

The wiring diagrams in Figures 1-4 ensure that, for a purely resistive load, current flowing in current transformer L1's primary circuit will have the same polarity as the applied voltage at TB1. If proper polarity is not followed, the Watts and Power Factor readings will be zero. To correct a zero Watts reading, simply reverse the direction of the load wire passing through the hole in L1.

- 7. Connector Torque Ratings:** It is important to tighten TB1's, screw-terminals to their rated torque specification of 3.6 pound-inches (0.4Nm). Proper tightening will minimize connector losses and ensure safe, reliable operation.

- 8. Isolation:** Except for the 2-56 thread metallic mounting studs, all of the ACM20 power meter's internal components (printed circuit board, resistor, capacitors, current transformer L1's secondary leads, etc.) are at the ac-mains potential connected to TB1. ACM20 power meters are designed to measure and be powered from one ac power-source only. Any other connection schemes will introduce significant measurement errors.

TYPICAL WIRING DIAGRAMS

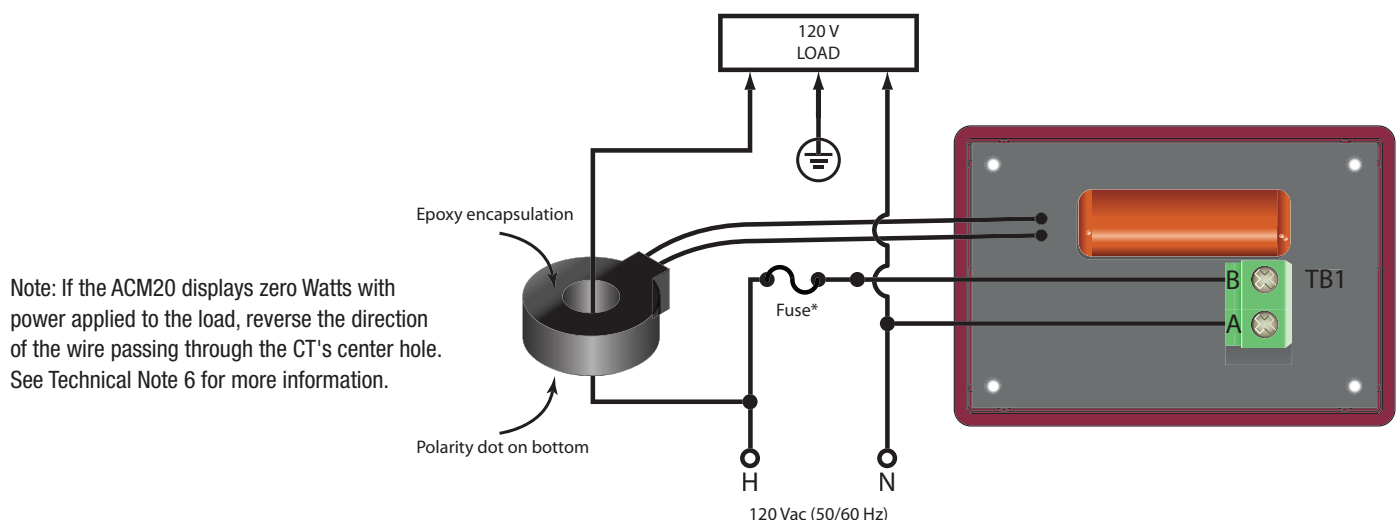

Figure 1. Wiring diagram for 110/120V single phase systems

*See technical note 5.

TYPICAL WIRING DIAGRAMS, CONT.

Note: If the ACM20 displays zero Watts with power applied to the load, reverse the direction of the wire passing through the CT's center hole. See Technical Note 6 for more information.



Figure 2. Wiring diagram for 220/240V systems with no neutral

*See technical note 5.

Note: If the ACM20 displays zero Watts with power applied to the load, reverse the direction of the wire passing through the CT's center hole. See Technical Note 6 for more information.



Figure 3. Wiring diagram for 120/240V systems with neutral (monitoring L1)

*See technical note 5.

Note: If the ACM20 displays zero Watts with power applied to the load, reverse the direction of the wire passing through the CT's center hole. See Technical Note 6 for more information.



Figure 4. Wiring diagram for 120/240V systems with neutral (monitoring L2)

*See technical note 5.

PANEL INSTALLATION

All connections to ACM20 power meters must be made after the unit is securely attached to the panel and with all associated load and supply voltages de-energized (off), using extreme caution and observing all safety measures applicable to the user's installation.

Care should be exercised when passing conductors through the power meter's built-in current transformer L1. The installed wire-positions should be such that minimal mechanical forces are applied to current transformer L1, TB1, or to the ACM20 power meter itself. In high-vibration environments, it is strongly recommended that adequate strain reliefs be used for all wiring.

Using Figure 5 as a guide, carefully insert the ACM20 assembly into the panel opening. From the rear of the panel, install and then tighten the four #2-56 hex nuts over the threaded studs. **Tighten each nut to 15 to 20 ozf-in (0.106 to 0.140 N-m).** Use only the factory-supplied hardware as the use of substitute hardware could result in an unsafe installation and/or adversely affect the reliability of the installation.

The recommended range of panel thickness that can be used with the supplied hardware is 0.040 inches (1.0mm) to 0.25 inches (6.4mm). Panel thicknesses outside of this range may require additional user-supplied hardware or modifications. Front panel space permitting, ACM20 power meters will fit most existing ACA-20RM / ACA-20PC ammeter cutouts, allowing for easy upgrading of existing installations.

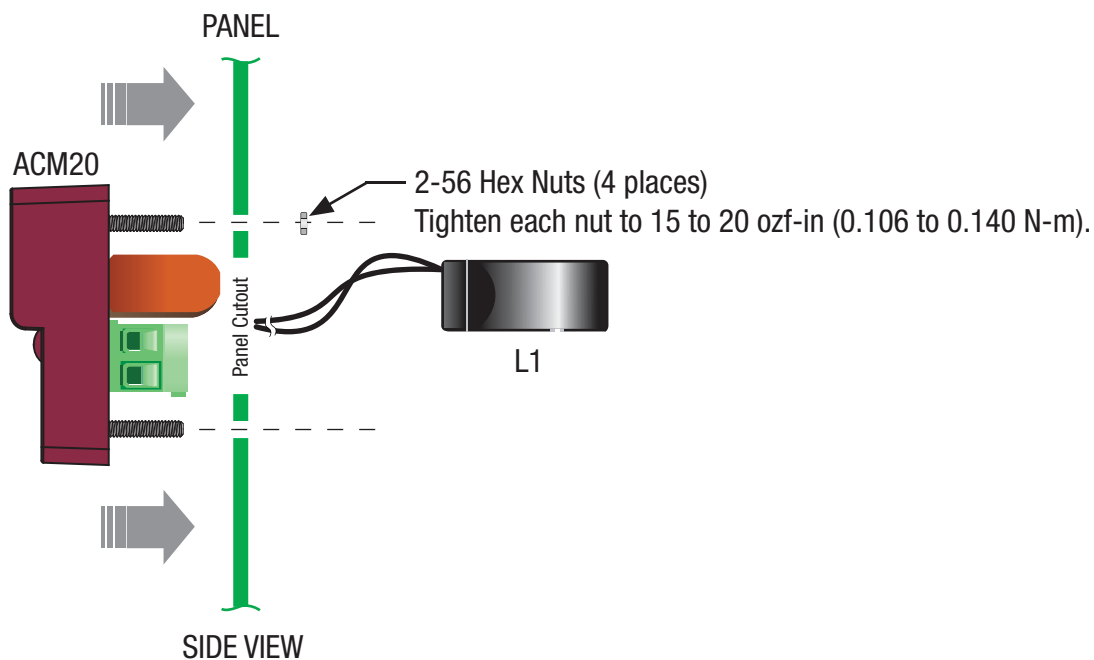
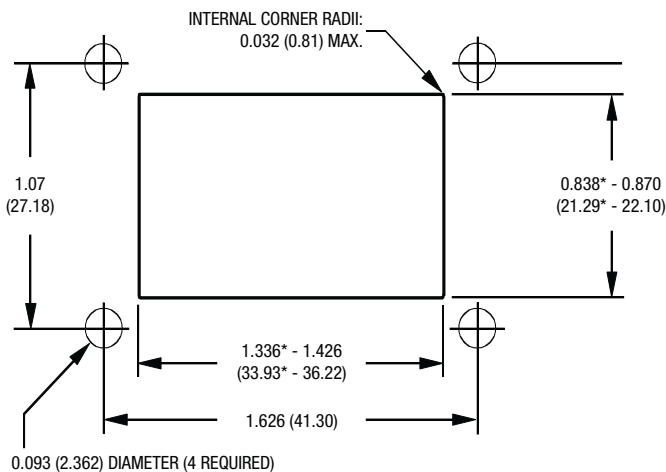

Figure 5. Panel Installation

PANEL CUTOUT

RECOMMENDED DRILL AND PANEL CUTOUT DIMENSIONS



* The two dimensions marked with an * specify the minimum recommended panel cutout opening for ACM20 power meters. Space permitting, the larger dimensions noted (0.87in., and 1.426in.) should be used. The panel opening must be centered vertically and horizontally between the four 0.093 (2.362mm) diameter holes.

MECHANICAL SPECIFICATIONS

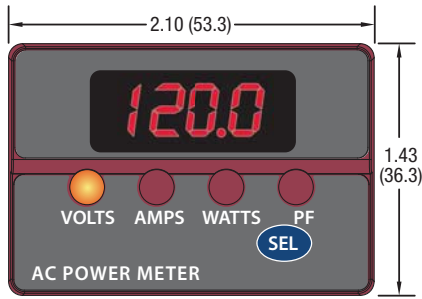

Front View

Dimensions are in inches (mm).

Tolerances (unless otherwise specified):

.XX ± 0.02 (0.51)

.XXX ± 0.010 (0.254)

Angles ± 2°

Components are shown for reference only.

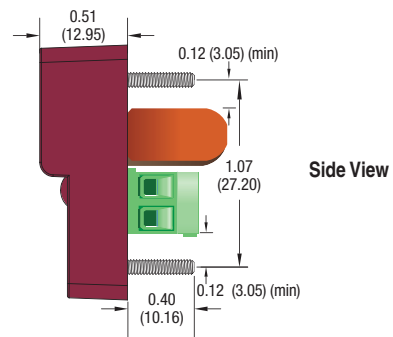

Side View

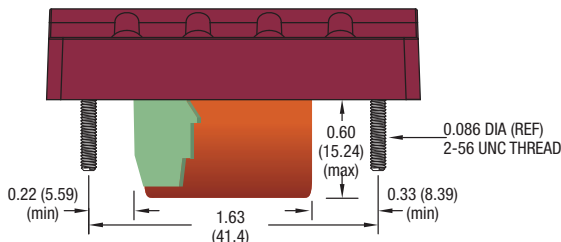

Bottom View

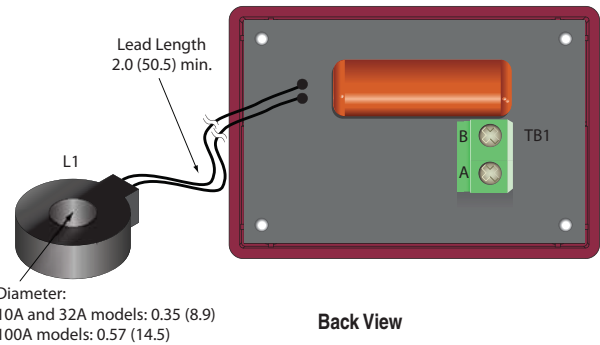

Back View

OSCILLOGRAMS

The graphs below show typical ACM20 power meter VOLTS readings when the unit is powered from four common ac-voltage waveforms.

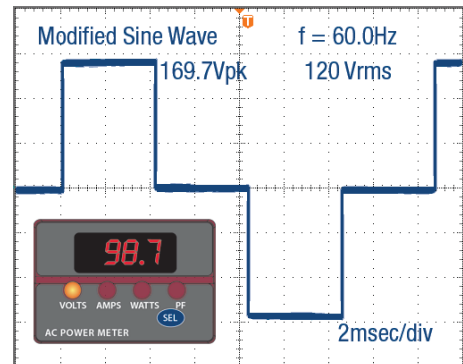
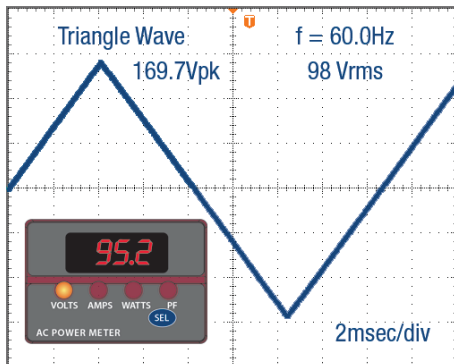
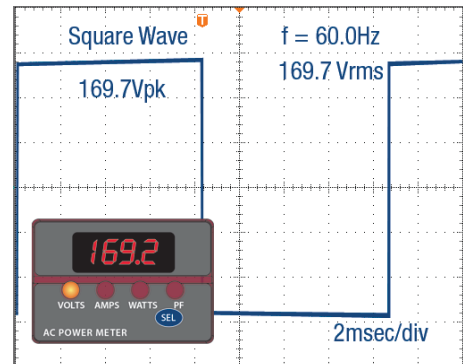
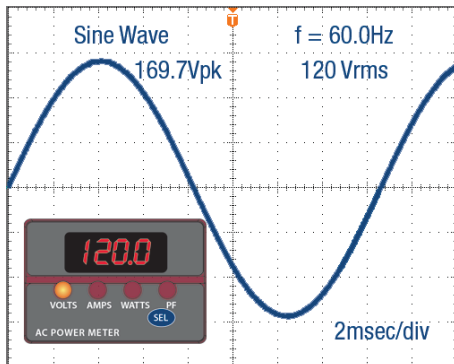

Murata Power Solutions, Inc.
11 Cabot Boulevard, Mansfield, MA 02048-1151 U.S.A.
ISO 9001 and 14001 REGISTERED

Murata Power Solutions, Inc. makes no representation that the use of its products in the circuits described herein, or the use of other technical information contained herein, will not infringe upon existing or future patent rights. The descriptions contained herein do not imply the granting of licenses to make, use, or sell equipment constructed in accordance therewith. Specifications are subject to change without notice. © 2012 Murata Power Solutions, Inc.

Данный компонент на территории Российской Федерации

Вы можете приобрести в компании MosChip.

Для оперативного оформления запроса Вам необходимо перейти по данной ссылке:

<http://moschip.ru/get-element>

Вы можете разместить у нас заказ для любого Вашего проекта, будь то серийное производство или разработка единичного прибора.

В нашем ассортименте представлены ведущие мировые производители активных и пассивных электронных компонентов.

Нашей специализацией является поставка электронной компонентной базы двойного назначения, продукции таких производителей как XILINX, Intel (ex.ALTERA), Vicor, Microchip, Texas Instruments, Analog Devices, Mini-Circuits, Amphenol, Glenair.

Сотрудничество с глобальными дистрибьюторами электронных компонентов, предоставляет возможность заказывать и получать с международных складов практически любой перечень компонентов в оптимальные для Вас сроки.

На всех этапах разработки и производства наши партнеры могут получить квалифицированную поддержку опытных инженеров.

Система менеджмента качества компании отвечает требованиям в соответствии с ГОСТ Р ИСО 9001, ГОСТ РВ 0015-002 и ЭС РД 009

Офис по работе с юридическими лицами:

105318, г.Москва, ул.Щербаковская д.3, офис 1107, 1118, ДЦ «Щербаковский»

Телефон: +7 495 668-12-70 (многоканальный)

Факс: +7 495 668-12-70 (доб.304)

E-mail: info@moschip.ru

Skype отдела продаж:

moschip.ru

moschip.ru_4

moschip.ru_6

moschip.ru_9