



Compact Power Line Shelves

Model: J85480S1, L1 – L14

The 1U (1.75") high CPL family of shelves mount in 19-inch wide frames and provide up to 11kW of 48V output power per shelf. There are three or four slots for rectifiers, converters (PEMs). L1 accepts the CP843A full featured Pulsar controller for applications requiring plant control.

| | |
|--|--|
| <ul style="list-style-type: none"> ▪ Only 16.81" wide fits inside equipment that is designed into a 19" rack ▪ Two DC Outputs may be common or split. Each output bus is rated for 100A with two-hole lug landings for 2 AWG wire. ▪ Either IEC-320 or AMP Mate_N_Lok AC inputs ▪ Analog, RS485 or dual/redundant I²C communications. ▪ Adjustable mounting ears for flush or set back positions. ▪ Stackable up to 8 high with 32 paralleled power supplies. ▪ Optional CP843A controller w/display & interactive panel | |
|--|--|

| Rectifier Shelves (AC Input, DC Output) | | | | | | | | | |
|---|-----------|-------------|-----------------|---------------|--------------------|--------------------------|--------------------------------|--------------------------|-------------|
| List | Max Power | # AC Inputs | AC Input Plug | DC Output Bus | Max Rectifier Size | Communications Features | | Ordering Codes | |
| | | | | | | Shelf Controller | Protocol | | |
| 1 | 8kW | 4 | IEC-320, C13 | Common | CP2000 | CP843A | Analog, I ² C RS485 | CC109143723 | |
| 4 | 8kW | | IEC-320, C13 | Common | | No | | Analog, I ² C | 108994538 |
| 6 | 8kW | | AMP Mate_N_Lok | Common | | | | | CC109104378 |
| 7 | 11kW | | AMP Mate_N_Lok | Split | CP2725 | CC109121902 | | | |
| 9 | 8kW | | IEC-320, C13 | Split | CP2000 | Analog, I ² C | CC109137072 | | |
| PEM Shelves (DC Input, DC Output) | | | | | | | | | |
| List | Capacity | # DC Inputs | DC Input Plug | DC Output Bus | Max PEM Size | Communications Features | | Ordering Codes | |
| | | | | | | Controller | Protocol | | |
| 14 | 8kW | 2 | AMP Power-Blade | Split | CP2000 | No | Analog, I ² C | CC109124764 | |

Notes:

List 1 shelf allows side access to CP843A Pulsar Controller Outputs.
L7, L9: Split Bus Shelves cannot be paralleled. L1, L4, L6: Up to eight shelves may be paralleled.

Consult the factory for product availability

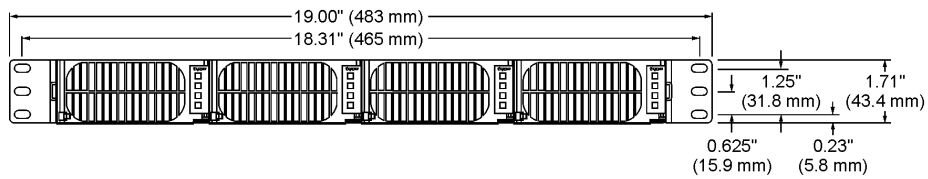
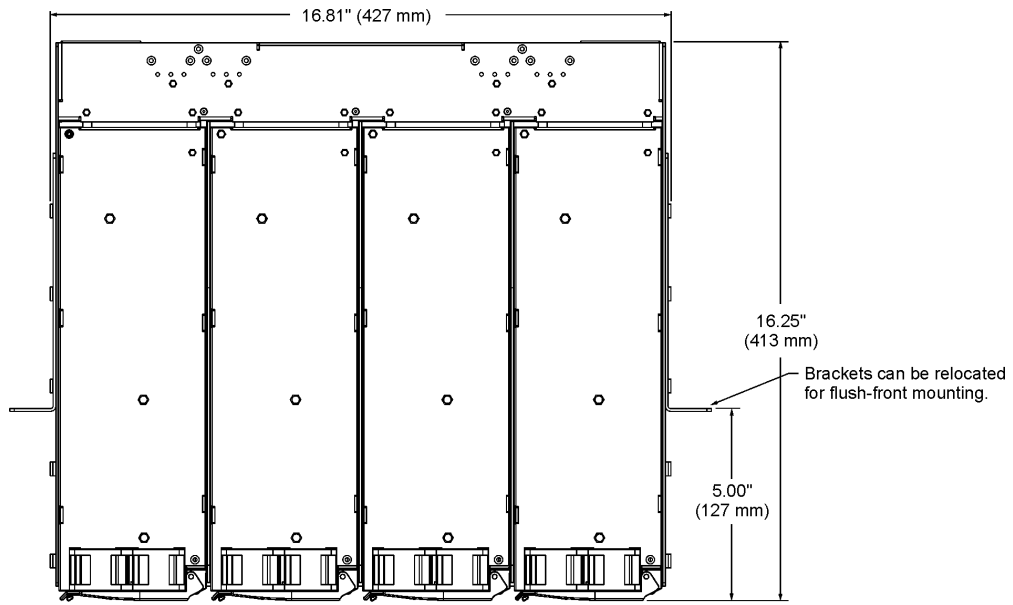

Package Outline

Rear Views

Lists 1, 4, 9

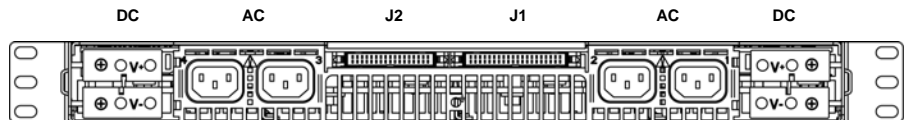

Lists 6, 7

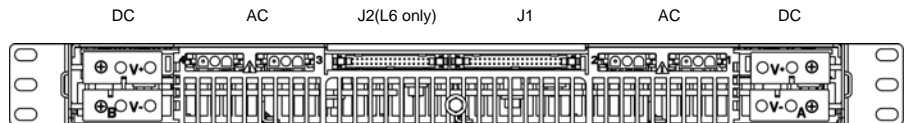

Lists 14

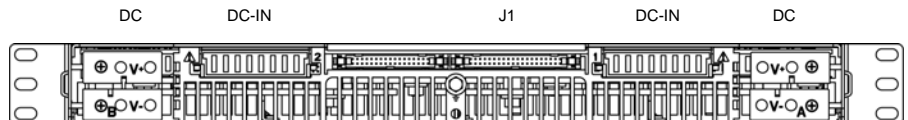

AC Input Connections

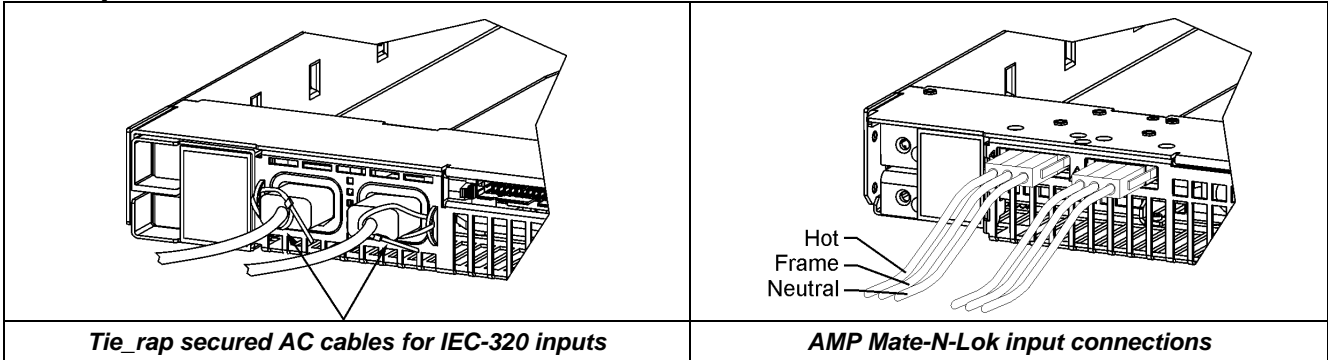

AMP Mate_N_Lok connector piece parts

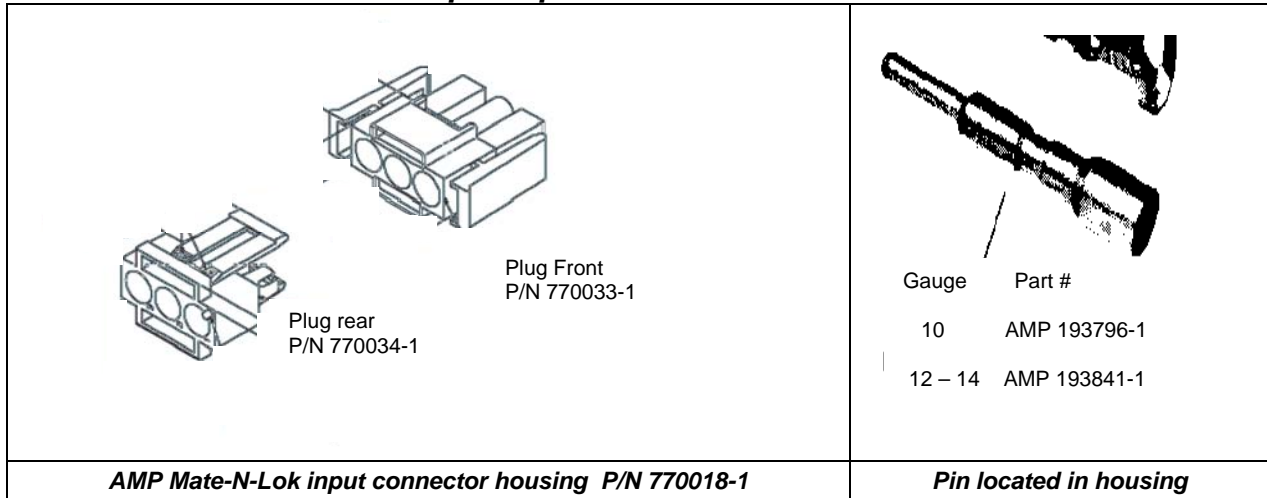

DC Input Connection – L14 shelf

Lineage orderable part #: CC848794908
Includes 4 feet of un-terminated #10ga stranded wires on one end and the AMP multi-beam connector on the other end.

Housing: AMP 1600798-6 multi-beam XL
Contacts: AMP 1-1600960-8
Wire: 10 ga stranded – 30A rated capacity

| Pins | Color | Signal | Unit |
|-------|-------|--------|------|
| 1 – 2 | Black | -48V | 1 |
| 3 – 4 | Red | RTN | |
| 5 – 6 | Black | -48V | 2 |
| 7 – 8 | Red | RTN | |

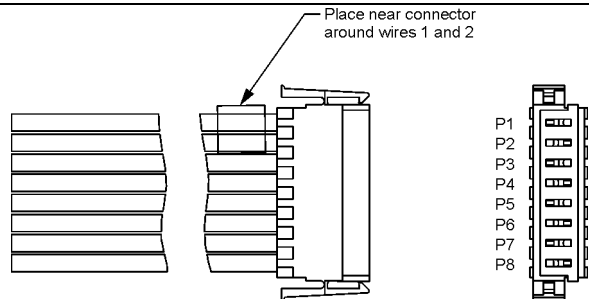

DC Output Connections

- Each Output Bus is rated for 100A and up to 2 gage two-hole lugs.
- M6 nuts with conical washers provided.
- Touch-Safe plastic covers around output buses.

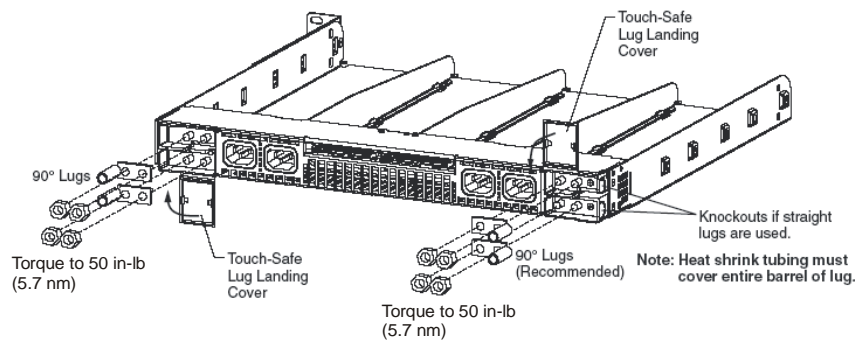

DC Split Output Bus Option

- Split Vout (-) buses on either side of the shelf. Vout (+) is common to both sections.
- +5V bias maintains I²C communications even during a feeder fault.
- Multiple shelves may not be paralleled together.

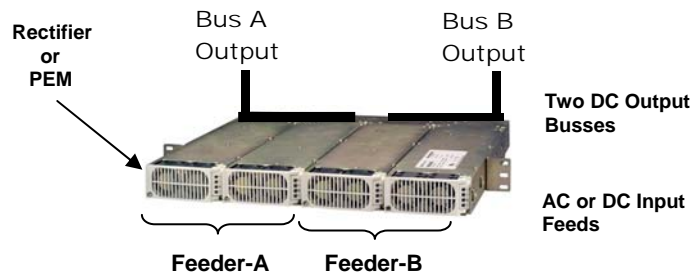

Controllerless Operation

- Lists 4 and 6 ship with a jumper installed on connector J1 pins 21 and 23. This allows the shelf to be powered without a controller. Remove this jumper if controller cable installed.
- CP843A controller ships with a connector that plugs into J1 on a List 1 shelf activating the controller.
- Lists 7, 9 and 14 require cc848836107 connector be installed in J1 to allow the shelf to power up without a controller.

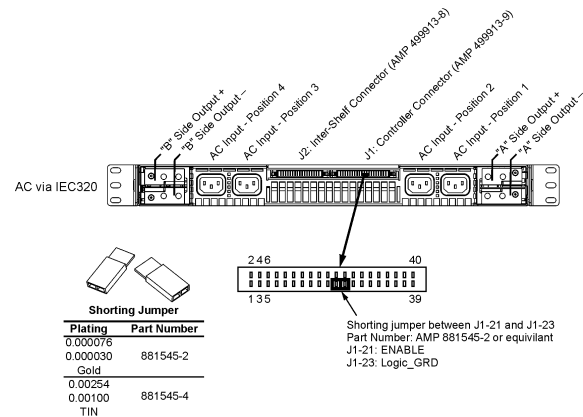

L7, L9, L14 P1 Mating connector (pin out is standard 40 position like L4)

| Type | Housing | Mating pin | Crimping tool |
|--------------------------|---|----------------------|---------------|
| Individual wire set | AMP 102387-9 RoHS | 20-24 awg: 6-87523-9 | 91517-1 |
| | | 22-26 awg: 6-87756-8 | 91517-1 |
| 40 position Ribbon cable | AMP 1658621-9 e/w 499252-1 (strain relief) RoHS | | |

This connector set is different because it can accept either a ribbon cable or an individual wire mate.

Communication Signals: J1 Connector

Pin out

| Pin | Signal | Pin | Signal |
|-----|-------------|-----|---------------|
| 1 | POWER_CAP_4 | 21 | Enable side A |
| 2 | POWER_CAP_3 | 22 | 5VA |
| 3 | POWER_CAP_2 | 23 | Logic_GRD |
| 4 | POWER_CAP_1 | 24 | Interrupt_1 |
| 5 | MOD_PRES_4 | 25 | Reset |
| 6 | MOD_PRES_3 | 26 | Enable Side B |
| 7 | MOD_PRES_2 | 27 | Spacing |
| 8 | MOD_PRES_1 | 28 | Spacing |
| 9 | PFW_4 | 29 | RS_485_Select |
| 10 | PFW_3 | 30 | Shelf_Addr_A |
| 11 | PFW_2 | 31 | Shelf_Addr_B |
| 12 | PFW_1 | 32 | Shelf_Addr_C |
| 13 | SCL_0 | 33 | Shelf_Addr_D |
| 14 | SCL_1 | 34 | Shelf_Addr_E |
| 15 | SDA_0 | 35 | Shelf_Addr_F |
| 16 | SDA_1 | 36 | Shelf_Addr_G |
| 17 | OTW | 37 | Protocol_S |
| 18 | Margin | 38 | RS-485+ |
| 19 | Fault | 39 | RS_485- |
| 20 | Interrupt_0 | 40 | Ishare |

Control Interface Connection (J1 - AMP 499913-9)

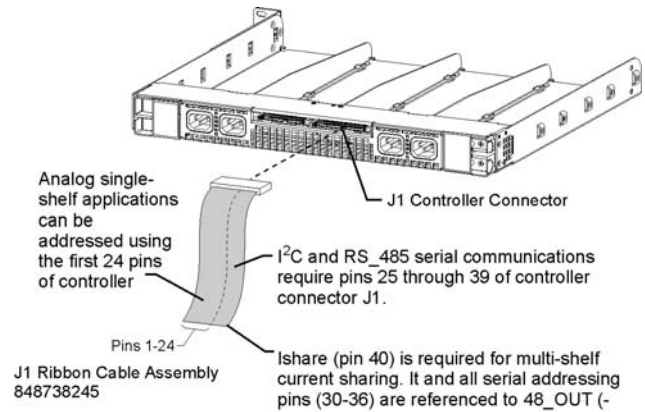

Communication Signals: J2 Connector (cannot be used in split shelves L7, L9, L14)

Pin out

| Pin | Signal | Pin | Signal |
|-----|---------------|-----|---------------|
| 1 | PFW_4 | 18 | Enable Side B |
| 2 | PFW_3 | 19 | Spacing |
| 3 | PFW_2 | 20 | Spacing |
| 4 | PFW_1 | 21 | RS_485_Select |
| 5 | SCL_0 | 22 | Shelf_Addr_B |
| 6 | SCL_1 | 23 | Shelf_Addr_C |
| 7 | SDA_0 | 24 | Shelf_Addr_D |
| 8 | SDA_1 | 25 | Shelf_Addr_E |
| 9 | OTW | 26 | Shelf_Addr_F |
| 10 | Margin | 27 | Shelf_Addr_G |
| 11 | Fault | 28 | Shelf_Addr_H |
| 12 | Interrupt_0 | 29 | Protocol_S |
| 13 | Enable side A | 30 | RS-485+ |
| 14 | 5VA | 31 | RS_485- |
| 15 | Logic_GRD | 32 | Ishare |
| 16 | Interrupt_1 | 33 | Spare |
| 17 | Reset | 34 | Spare |

Multi-shelf Connection (J2 – AMP 499913-8)

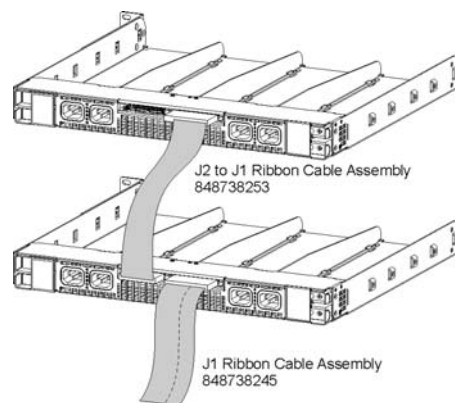

Note: Shelf addressing, current share and RS485 communications are all referenced to the most negative power output Vout(-) of the shelf. For paralleled shelves the Vout(-) terminations must be tied together in order to ensure proper operation of these functions. Modules could get damaged if this connection is not made. .



- CP843A installs in slot 1 of a J85480S1 List 1 shelf. Connections to the controller are made on the left side as shown.
- CP843A controller comes with wire set that plugs into J1 connector to enable the controller.



Specifications

| Parameter | Min | Max | Notes |
|------------------------------------|---|------------|--|
| Input | | | |
| AC Input Current, per module | | 15A 30A | IEC-320, C13 type AMP Mate-N-Lok connectors |
| DC Input Current, per module | | 60A | |
| Output | | | |
| Programmable output set point | 42Vdc | 58Vdc | Minimum 44Vdc via hardware marginning |
| Max Output Current | J85480S1 | 200A | lugs for 2 ga wires, 2 pairs, 100Amax |
| Output Terminations | | | M6 threaded studs on 5/8-inch centers. |
| Environmental | | | |
| Operating Temperature Range | -40°C to 55°C, except J85480 L6, L7, L14 may be used up to 75°C | | |
| Operating Relative Humidity | 0 - 95% (non-condensing) | | |
| Storage Temperature Range | -40°C to 85°C | | |
| EMC | FCC, EN 55022, CISPR22, Level A, conducted and radiated | | |
| Immunity | FCC and CISPR22 (EN55022) Class A2 | | |
| Safety/Standards Compliance | | | |
| Safety Standards | UL1950, EN60950 (IEC950), CSA*234/950 | | |
| Certification Marks | Lists 6,7,14: VDE, UL Recognized (Canada and U.S.) Lists 1,4,6,9: VDE, UL Listed (Canada and U.S.) | | |

Ordering Information

| Part Number | Description | Comcode | Usage |
|---|---|--------------|---|
| Blank Slot Fillers | | | |
| | Central Office White | CC848822263 | All |
| | Raven Black | CC848781534 | |
| | Graphite | CC848825233 | |
| Extensions and mounting brackets | | | |
| | CP 19 inch mounting bracket kit (includes two brackets and mounting hardware) | CC109145760 | L8 |
| | 1U high extension bracket kit for 23" cabinets (includes two brackets and mounting hardware) | CC848844803 | All |
| | 2U high extension bracket kit for 23" cabinets (includes two brackets and mounting hardware) | 848683009 | All |
| Cables / Connectors for J85480S1 Shelves | | | |
| | Ribbon cable for attaching a controller to the power shelf – 10 ft. One end mates into J1 the other end not terminated. | 848738245 | L1, L4, L6 |
| | Inter-shelf connector for daisy-chaining shelves – 9 in between J1 of 2 nd and J2 of 1 st shelf | 848738253 | L1, L4, L6 |
| | 2 AWG DC output cable set – 10 ft (1 RED and 1 BLACK cable) | 848748987 | All |
| | AC Input cable: High temperature IEC 320 C13 straight over-mold (one end), NEMA5-15P plug (one end), 14 AWG, 10 ft | CC848776105 | L4, L5 |
| | AC input cable: IEC 320 C13 plug (one end), other end not terminated , 14 AWG, 14 ft, | 847861192 | L1, L4, L9 |
| | AC input cable: AMP 3-pin Mate-N-Lok, 14 AWG, 3 ft, other end not terminated | CC848763301 | L6, L7, L8, L9 |
| | AC input cable: AMP 3-pin Mate-N-Lok, 14 AWG, 10 ft, other end not terminated | CC848793026 | L6, L7, L8, L9 |
| | Inter-shelf cable for RS-485 specific shelf. | CC848786153 | L8 |
| | Office alarm cable for RS-485 specific shelf | CC848786161 | L8 |
| | DC input cable – 4 ft | CC848794908 | L14 |
| | Shorting jumper for J1 connector ENABLE for single output shelf (see locating picture) | AMP 881545-2 | L4, L6, |
| | P1 connector ENABLE jumper for split shelf | CC848836107 | L7, L9, L14 |
| Pulsar Controllers for J85480S1 Shelves | | | Picture |
| NE843G | 1U standalone Controller (Display, DB9 craft port and RJ45 ethernet) | CC109139358 |  |
| CP843A | CP Shelf Mounted Controller (Display and RJ45 ethernet) | CC109129895 |  |
| Cables for Pulsar Controllers | | | |
| | NE843G to CP Shelf Cable Kit (Includes 2ft power and communication cable) | CC109144820 | |
| | J4 Output Alarm Cable 50ft – 24ga solid twisted pair | CC848817635 | |
| | J4 Output Alarm Cable 150ft – 24ga solid twisted pair | CC848817643 | |
| | J3 Input Alarm Cable 50ft – 24ga Stranded | CC848817651 | |
| | J3 Input Alarm Cable 150ft – 24ga Stranded | CC848817668 | |

Safety

Safety Symbols and Guidelines

Read and understand all instructions before attempting any installation of this product. When installing, operating, or maintaining the J85480S1 Power System, basic safety precautions should always be followed to reduce the risk of fire, electric shock, and injury to persons. Such precautions include the following:



This symbol identifies the need to refer to the equipment instructions for important information.



This symbol identifies the presence of hazardous AC or DC voltages or hazardous energy levels. In the context of this product

- The DC output cables contain electrical energy levels capable of causing heating and arcing if shorted to metal objects. Make connections with the power disconnected.
- Hazardous AC voltage and DC electrical energy is contained within the enclosure of the power shelf. No user or field serviceable parts inside.



This symbol is used to identify safety earth ground connection points within the equipment.

Product Labeling

Follow all warnings and instructions marked on the product. Some of the safety symbols used with the CP1800 Rectifier and J85480S1 Shelf may include the following. They may also be accompanied by instructions:

Mounting and Installation

- This product shall be installed in compliance with mounting requirements for the ultimate application.
- This product must be installed, serviced, and operated only by skilled and qualified personnel who have the necessary knowledge and practical experience with electrical equipment and who understand the hazards that can arise when working on this type of equipment. This product is intended for use in a Restricted Access Location.
- This equipment is to be used in controlled environments (an area where the humidity is maintained at levels that cannot cause condensation on the equipment, the contaminating dust is controlled, and the steady-state ambient temperature is within the range specified).
- This equipment has been evaluated for use in a continuous ambient temperature of up to 55°C and the application environment should not exceed 55°C.
- The CE mark if provided on the product is applied to show conformance to the requirements outlined in the European Union's Low Voltage Directive {72/73/EEC} and EMC Directive {89/336/EEC}, as amended by the CE Mark Directive {93/ 68/EEC}.
- The J85480S1 shelf, when used with the CP1800 rectifiers, has been evaluated for hot swapping.
- A separate protective Earthing terminal is provided at the reach of the shelf
 - the building installation shall provide a means for connection to protective earth; and
 - the equipment is to be connected to that means; and
 - a SERVICE PERSON shall check whether or not the socket-outlet from which the equipment is to be powered provides a connection to the building protective earth. If not, the SERVICE PERSON shall arrange for the installation of a PROTECTIVE EARTHING CONDUCTOR from the separate protective Earthing terminal to the protective earth wire in the building.

Output Connections

- All field wiring should comply with the U.S. National Electrical Code (NEC) and/or applicable local codes/standards.
- Routing of the DC output cables should guarantee that cables are not in contact with sources of heat and surfaces that may damage the cable insulation.
- The DC output is not provided with a fuse or circuit breaker suitable for branch circuit protection. Therefore, the power shelf should be mounted in the same rack or cabinet as the equipment being powered. Use interconnecting power cables suitable for the application and sized to carry the rated output current. The interconnecting cables should be capable of carrying the overload current and short circuit current without damage or risk of fire.
- The output for the system is SELV and has available power greater than 240VA.
- Insulation on output field-wired conductors should be rated no less than 90°C. Wiring internal to enclosed equipment cabinets should be rated at 105°C (minimum). The provided DC output cords (red and black wires) are rated for 105°C.
- Before opening the insulating cover to gain access to load and ground connections, ensure all power supplies are disconnected from the AC MAINS.

AC Input Connections

- AC branch circuits to this equipment must be protected with fuses or circuit breakers sized as required by the U.S. National Electric Code (NEC) and/or local codes. Up to four AC mains power cords are required to power the shelf (one for each rectifier). Each power cord should be connected to a separate AC mains branch circuit with an overcurrent protector rated at no more than 20A.
- The power supply mains inlet may be used as the means to provide AC protective earthing.
- An accessible AC disconnect/protection device to remove AC power from the equipment in the event of an emergency must be provided. An accessible socket-outlet/receptacle installed near the equipment is also acceptable as a disconnect.
- The equipment is powered by multiple AC inputs (one per rectifier). Disconnect all AC sources of power before servicing.
- These units are to be used with TN-S power systems only.

German Safety Guidelines

Installationsanleitung

- Alle Ausgänge des Gerätes erfüllen die Anforderungen für SELV nach IEC/EN60950-1.
- Die Ausgänge des Gerätes liegen über den Limits für Energiegefahr nach IEC/EN60950-1 (>240 VA). Das Gerät ist zum Einbau in ein Montage-Rack bestimmt. Siehe Einbaubestimmungen in der Montageanleitung, um eine Gefährdung des Benutzers während der Installation zu vermeiden.

ACHTUNG:

Hoher Ableitstrom Vor Anschluss an den Versorgungsstromkreis unbedingt Erdungsverbinding herstellen

- Das Produkt ist zum Gebrauch in einer Umgebungstemperatur von max. 55°C bestimmt.
- Die Gerätestecker des Produktes sind dazu bestimmt, eine sichere Erdung des Gerätes herzustellen.
- Das Produkt ist zum Gebrauch in einer Umgebung mit Verschmutzungsgrad 2 nach IEC/EN60950 bestimmt.
- Die Netzteile des Gerätes können während des Betriebes einzeln ausgetauscht werden (Hot Swapping).
- Das Gerät wurde zusammen mit den Anschlussleitungen (ohne Anschlussstecker) geprüft. Die Installation eines Steckers des jeweiligen Landes, sollte nur durch geschultes Service Personal durchgeführt werden. Als alternative könnte eine Vorinstallation des Steckers bereits bei der Herstellung erfolgt sein.



World Wide Headquarters

Lineage Power
3000 Skyline Drive, Mesquite, TX 75149, USA
+1-800-843-1797
power.lineagepower.com

Europe, Middle-East and Africa Headquarters

Lineage Power (UK)
Tel: +44 (0) 1344 469 300, Fax: +44 (0) 1344 469 301

Caribbean-Latin America-Brazil Headquarters

Lineage Power
Tel: +56 2 209 8211, Fax: +56 2 223 1477

Asia-Pacific Headquarters

Lineage Power Singapore
Tel: +65 6416 4283, Fax: +66 6416 4299

India

Lineage Power India
Tel: +91 80 841 1633 x3001

Lineage Power reserves the right to make changes to the product(s) or information contained herein without notice. No liability is assumed as a result of their use or application. No rights under any patent accompany the sale of any such product(s) or information.

©2010 Lineage Power (Mesquite, Texas) All International Rights Reserved.

GGS – March 2010

Данный компонент на территории Российской Федерации

Вы можете приобрести в компании MosChip.

Для оперативного оформления запроса Вам необходимо перейти по данной ссылке:

<http://moschip.ru/get-element>

Вы можете разместить у нас заказ для любого Вашего проекта, будь то серийное производство или разработка единичного прибора.

В нашем ассортименте представлены ведущие мировые производители активных и пассивных электронных компонентов.

Нашей специализацией является поставка электронной компонентной базы двойного назначения, продукции таких производителей как XILINX, Intel (ex.ALTERA), Vicor, Microchip, Texas Instruments, Analog Devices, Mini-Circuits, Amphenol, Glenair.

Сотрудничество с глобальными дистрибьюторами электронных компонентов, предоставляет возможность заказывать и получать с международных складов практически любой перечень компонентов в оптимальные для Вас сроки.

На всех этапах разработки и производства наши партнеры могут получить квалифицированную поддержку опытных инженеров.

Система менеджмента качества компании отвечает требованиям в соответствии с ГОСТ Р ИСО 9001, ГОСТ РВ 0015-002 и ЭС РД 009

Офис по работе с юридическими лицами:

105318, г.Москва, ул.Щербаковская д.3, офис 1107, 1118, ДЦ «Щербаковский»

Телефон: +7 495 668-12-70 (многоканальный)

Факс: +7 495 668-12-70 (доб.304)

E-mail: info@moschip.ru

Skype отдела продаж:

moschip.ru

moschip.ru_4

moschip.ru_6

moschip.ru_9