

RoHS  **233 Series, 5 x 20 mm, Medium-Acting Fuse**

Description

5x20mm medium-acting glass body fuse designed to UL specification.





Features

- Designed to UL/CSA/ANCE 248 Standard
- Available in cartridge and axial lead format
- RoHS compliant and lead-free

Applications

Used as supplementary protection in appliance or utilization equipment to provide individual protection for components or internal circuits.

Agency Approvals

Agency	Agency File Number	Ampere Range
	Cartridge Certificates: NBK190609-JP1021A NBK030609-JP1021B	1A – 5A 6A – 10A
	Leaded Certificates: NBK190609-JP1021B NBK030609-JP1021D	1A – 5A 6A – 10A
	Certificates: SU05001 – 2010	1A – 6.5A
	Listed File: E10480 Guide: JDYX	1A – 10A
	File: 029862 Acc. Class: LR1422-01	1A – 6A 8A – 10A
		1A – 10A

Electrical Characteristics for Series

% of Ampere Rating	Ampere Rating	Opening Time
100%	1A – 3.5A	4 hours, Minimum
	4A – 7A	1 hour, Minimum
	8A – 10A	1 hour, Minimum
135%	1A – 3.5A	15 sec., Min; 1500 sec., Max.
	4A – 7A	15 sec., Min; 1500 sec., Max.
	8A – 10A	3 sec., Min; 3600 sec., Max.
200%	1A – 3.5A	.60 sec., Min; 3 sec., Max.
	4A – 7A	.60 sec., Min; 3 sec., Max.
	8A – 10A	0.4 sec., Min; 2.25 sec., Max.

Electrical Characteristic Specifications by Item

Amp Code	Amp Rating (A)	Voltage Rating (V)	Interrupting Rating	Nominal Cold Resistance (Ohms)	Nominal Melting I ² t (A ² sec)	Agency Approvals				
										
001.	1	125	10,000A @ 125 VAC	0.1750	1.97500	x	x	x	x	x
1.25	1.25	125		0.1263	3.39000	x	x	x	x	x
01.6	1.6	125		0.0880	6.14000	x	x	x	x	x
002.	2	125		0.0684	9.97000	x	x	x	x	x
02.5	2.5	125		0.0521	17.04500	x	x	x	x	x
003.	3	125		0.0431	26.24000	x	x	x	x	x
3.15	3.15	125		0.0380	29.79500	x	x	x	x	x
03.5	3.5	125		0.0322	36.27500	x	x	x	x	x
004.	4	125		0.0293	51.61000	x	x	x	x	x
005.	5	125		0.0217	89.97500	x	x	x	x	x
006.	6	125		0.0179	131.45500	x	x	x	x	x
06.3	6.3	125		0.0166	151.90500	x	x	x	x	x
007.	7	125		0.0137	157.31000	x	x		x	
008.	8	125		0.0084	169.43500	x	x	x	x	
010.	10	125		0.0066	274.11500	x	x	x	x	

Temperature Derating Curve

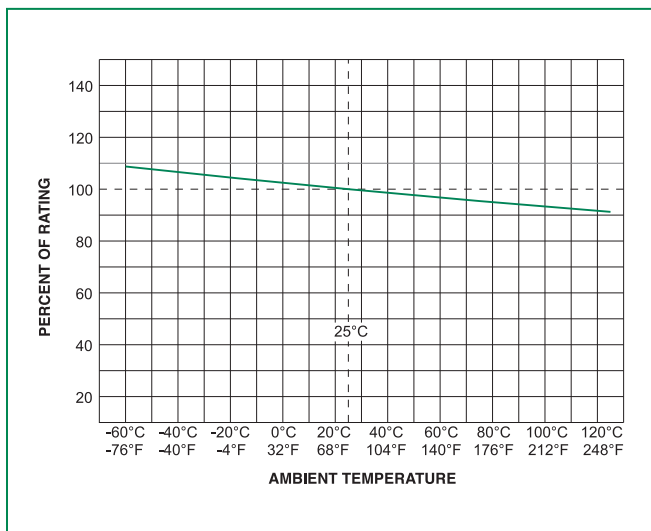

Average Time Current Curves



Soldering Parameters - Wave Soldering

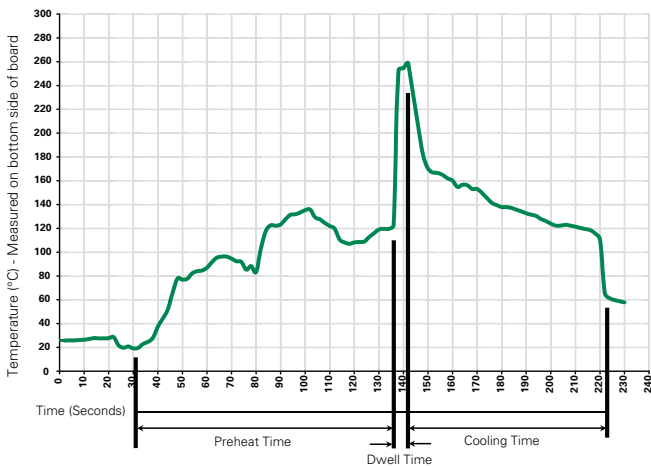

Recommended Process Parameters:

Wave Parameter	Lead-Free Recommendation
Preheat: (Depends on Flux Activation Temperature)	
Temperature Minimum:	100° C (Typical Industry Recommendation)
Temperature Maximum:	150° C
Preheat Time:	60-180 seconds
Solder Pot Temperature:	260° C Maximum
Solder Dwell Time:	2-5 seconds

Recommended Hand-Solder Parameters:

Solder Iron Temperature: 350° C +/- 5°C
Heating Time: 5 seconds max.

Note: These devices are not recommended for IR or Convection Reflow process.

Product Characteristics

Materials	Body: Glass Cap: Nickel-plated brass Leads: Tin-plated Copper
Terminal Strength	MIL-STD-202G, Method 211A, Test Condition A
Solderability	Reference IEC 60127 Second Edition 2003-01 Annex A
Product Marking	Cap 1: Brand logo, current and voltage rating Cap 2: Series and agency approval markings
Packaging	Available in Bulk (M=1000 pcs/pkg) or on Tape/Reel (MRET1=1000 pcs/reel)

Operating Temperature	-55°C to +125°C
Thermal Shock	MIL-STD-202G, Method 107G, Test Condition B: (5 cycles -65°C to +125°C)
Vibration	MIL-STD-202G, Method 201A
Humidity	MIL-STD-202G, Method 103B, Test Condition A. high RH (95%) and elevated temp (40°C) for 240 hours
Salt Spray	MIL-STD-202G, Method 101D, Test Condition B

Dimensions

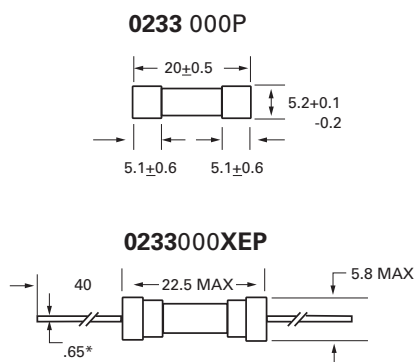

All dimensions in mm

Notes:

* Ratings above 6.3A have 0.8 mm dia lead

Part Numbering System

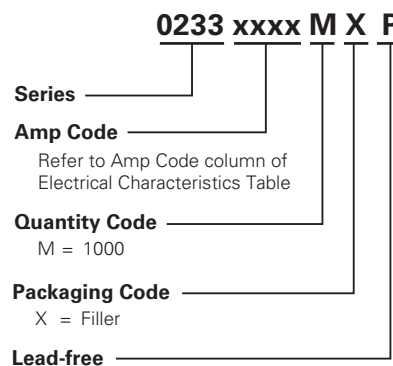

Packaging

Packaging Option	Packaging Specification	Quantity	Quantity & Packaging Code	Taping Width
233 Series				
Bulk	N/A	1000	MX	N/A
Bulk	N/A	1000	MXE	N/A
Reel and Tape	EIA 296-E	1000	MRET1	T1=53mm (2.087")
Bulk	N/A	1000	MXB	N/A

Данный компонент на территории Российской Федерации

Вы можете приобрести в компании MosChip.

Для оперативного оформления запроса Вам необходимо перейти по данной ссылке:

<http://moschip.ru/get-element>

Вы можете разместить у нас заказ для любого Вашего проекта, будь то серийное производство или разработка единичного прибора.

В нашем ассортименте представлены ведущие мировые производители активных и пассивных электронных компонентов.

Нашей специализацией является поставка электронной компонентной базы двойного назначения, продукции таких производителей как XILINX, Intel (ex.ALTERA), Vicor, Microchip, Texas Instruments, Analog Devices, Mini-Circuits, Amphenol, Glenair.

Сотрудничество с глобальными дистрибьюторами электронных компонентов, предоставляет возможность заказывать и получать с международных складов практически любой перечень компонентов в оптимальные для Вас сроки.

На всех этапах разработки и производства наши партнеры могут получить квалифицированную поддержку опытных инженеров.

Система менеджмента качества компании отвечает требованиям в соответствии с ГОСТ Р ИСО 9001, ГОСТ РВ 0015-002 и ЭС РД 009

Офис по работе с юридическими лицами:

105318, г.Москва, ул.Щербаковская д.3, офис 1107, 1118, ДЦ «Щербаковский»

Телефон: +7 495 668-12-70 (многоканальный)

Факс: +7 495 668-12-70 (доб.304)

E-mail: info@moschip.ru

Skype отдела продаж:

moschip.ru

moschip.ru_4

moschip.ru_6

moschip.ru_9