

Features

- Passive Frequency Mixer
- Conversion Loss: 8 dB @ 12 GHz
- High IIP3: 23 dBm @ 12 GHz
- RF Frequency: 5 - 35 GHz
- LO Frequency: 3 - 33 GHz
- IF Frequency: DC - 4.5 GHz
- Lead-Free 1.5 x 1.2 mm TDFN 6-lead Package
- Halogen-Free “Green” Mold Compound
- RoHS* Compliant

Description

The MAMX-011021 is a passive mixer “engine” assembled in a 1.5 x 1.2 mm TDFN 6-lead plastic package. This device is designed for more linear applications such as high bit rate transmitters and receivers which may be used in Point-to-Point, Satcom or LAN applications. The mixer has 8 dB of conversion loss and 23 dBm of input intercept point (IIP3).

This mixer can be used for either lower sideband (LSB) or upper sideband (USB) mixing. Two of these mixers can be combined in a quadrature configuration for image rejection.

Positive bias voltage (< 1 V) can be applied to the LO or the V_G (optional) pin to reduce LO drive requirements. The V_G pin is internally bypassed. Positive bias voltage (< 1 V) can also be applied to the IF pin to optimize device linearity.

Ordering Information^{1,2}

| Part Number | Package |
|--------------------|-----------------|
| MAMX-011021-TR1000 | 1000 piece reel |
| MAMX-011021-TR3000 | 3000 piece reel |
| MAMX-011021-SMB | Sample Board |

1. Reference Application Note M513 for reel size information.
2. All sample boards include 5 loose parts.

Functional Schematic

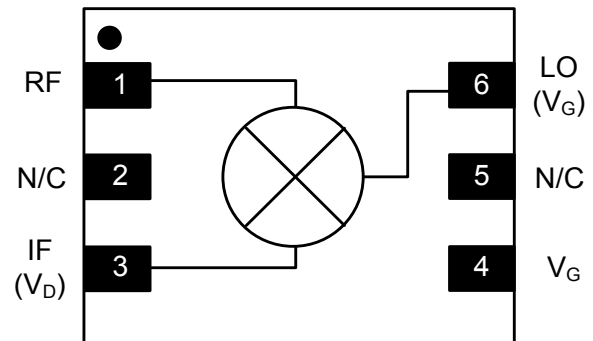

Pin Configuration³

| Pin No. | Pin Name | Description |
|---------|---------------------|-------------------------------------|
| 1 | RF | RF Port |
| 2 | N/C | No Connection |
| 3 | IF (V_D) | IF Port (optional Drain Voltage) |
| 4 | V_G | Gate Voltage (optional) |
| 5 | N/C | No Connection |
| 6 | LO (V_G) | LO Port (optional Gate Voltage) |
| 7 | Paddle ⁴ | Ground |

3. MACOM recommends connecting No Connection pins to ground.
4. The exposed pad centered on the package bottom must be connected to RF, DC and thermal ground.

* Restrictions on Hazardous Substances, European Union Directive 2011/65/EU.

Electrical Specifications: $T_A = +25^\circ\text{C}$, $V_D = \text{open}$, $V_G = \text{open}$, $Z_0 = 50 \Omega$,
IF Freq. = 2 GHz, LO Drive = 14 dBm @ 10 GHz, RF Freq. = 12 GHz

| Parameter | Test Conditions | Units | Min. | Typ. | Max. |
|-----------------|----------------------------|-------|------|-------------------|---------------|
| Conversion Loss | 6 GHz 12 GHz 30 GHz | dB | — | 9.5 8.0 8.5 | — 9.0 — |
| RF Return Loss | 5 - 35 GHz | dB | — | 8 | — |
| LO Return Loss | 5 - 35 GHz | dB | — | 10 | — |
| IF Return Loss | DC - 4.5 GHz | dB | — | 12 | — |
| Input P1dB | — | dBm | — | 15 | — |
| Input IP3 | $P_{IN} = -15 \text{ dBm}$ | dBm | — | 23 | — |

Absolute Maximum Ratings^{5,6}

| Parameter | Absolute Maximum |
|-----------------------------------|------------------|
| Input Power | 22 dBm |
| Drain Voltage | 2 V |
| Gate Voltage | 1 V |
| Junction Temperature ⁷ | +150°C |
| Operating Temperature | -40°C to +85°C |
| Storage Temperature | -65°C to +150°C |

- Exceeding any one or combination of these limits may cause permanent damage to this device.
- MACOM does not recommend sustained operation near these survivability limits.
- Operating at nominal conditions with $T_J \leq +150^\circ\text{C}$ will ensure $\text{MTTF} > 1 \times 10^6$ hours.

Handling Procedures

Please observe the following precautions to avoid damage:

Static Sensitivity

Gallium Arsenide Integrated Circuits are sensitive to electrostatic discharge (ESD) and can be damaged by static electricity. Proper ESD control techniques should be used when handling these Class 1A (HBM) devices.

Application Information

The MAMX-011021 is designed to be an economical and easily used mixer. The ultra small size and passive structure allows easy placement on any system board.

Recommended PCB Layout

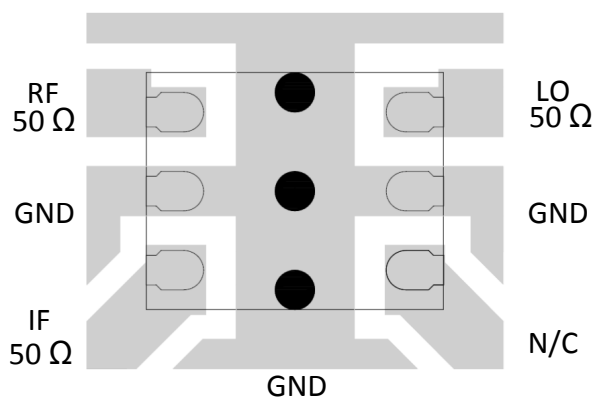

Grounding

It is recommended that the total ground (common mode) inductance not exceed 0.03 nH. This is equivalent to three 8-mil (200 μ m) diameter vias under the device on an 8-mil thick PC board combined with vias included in the ground plane around the package.

Optional DC Biasing

As shown in the Application Schematic, the MAMX-011021 does not require DC biasing. The V_G pin should be left open if not used for biasing.

Optionally, applying up to 0.5 V bias through the V_G pin (or through the LO pin) can reduce the mixer LO drive requirement (in general, reducing LO drive will reduce input IP3). Any DC voltage applied through the V_G pin will appear on the LO pin, so when biasing V_G it may be necessary to have a DC blocking capacitor on the LO pin. See the Optional Biasing Schematic.

Input IP3 may be increased by applying small amounts of voltage ($V_D < 1.0$ V) to the IF pin. The IF pin will draw a small current (typically less than 20 mA) when V_D is positive so bias through an inductor or resistor (accounting for the voltage drop). The inductor or the resistor should have an impedance large compared to 50 Ω at the IF frequency (typically at least 200 Ω).

Application Schematic

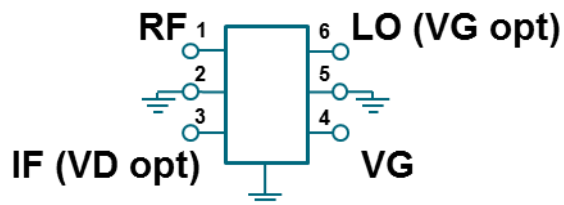

Optional DC Biasing Schematic

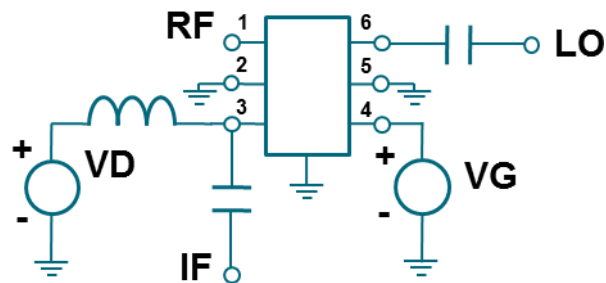

High Linearity Mixer 5 - 35 GHz

Rev. V1

Typical Performance Curves: Down Conversion,
 RF = -20 dBm, LO = 14 dBm, IF = 2 GHz, V_G = open, Z_O = 50 Ω , (unless otherwise noted)

Conversion Gain (down)

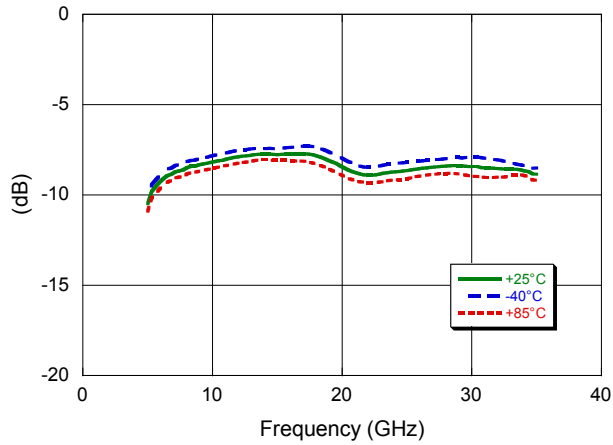

Conversion Gain (up)

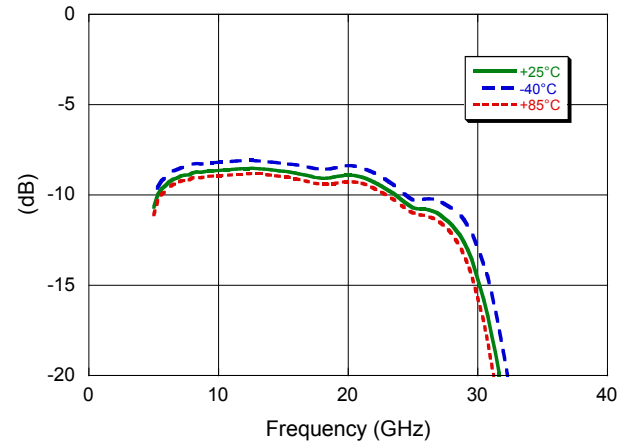

Isolation

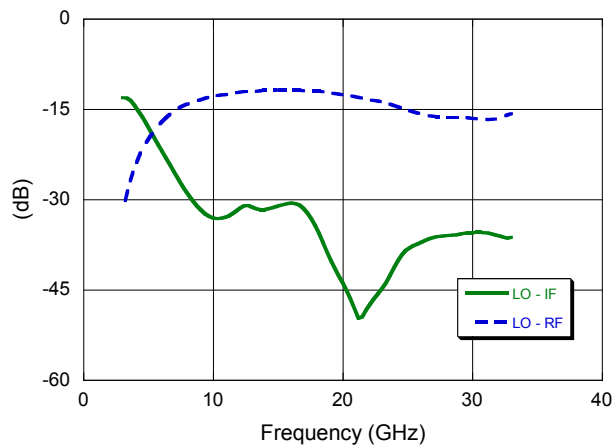

Gain vs. IF Frequency

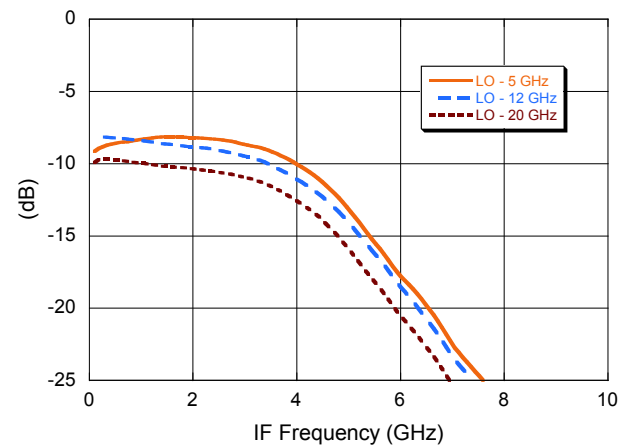

Input IP3

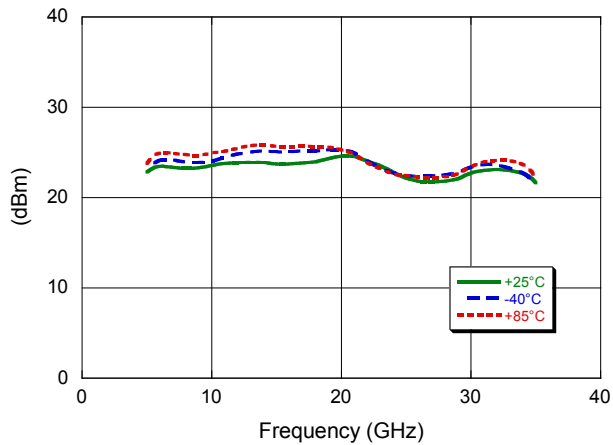

Input P1dB

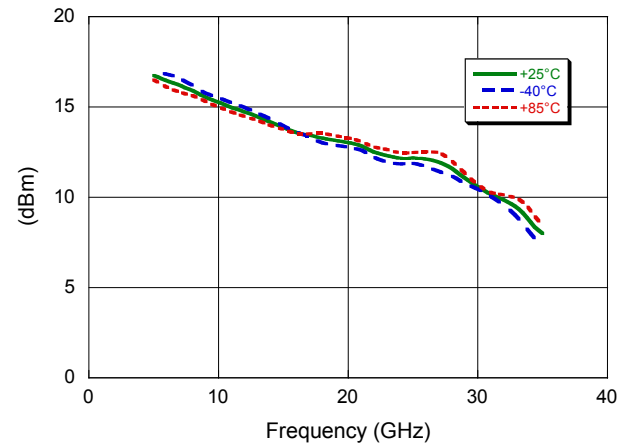

High Linearity Mixer 5 - 35 GHz

Rev. V1

Typical Performance Curves: Down Conversion,
RF = -20 dBm, LO = 14 dBm, IF = 2 GHz, V_G = open, Z_O = 50 Ω , (unless otherwise noted)

Conversion Gain (LSB) vs. LO Drive

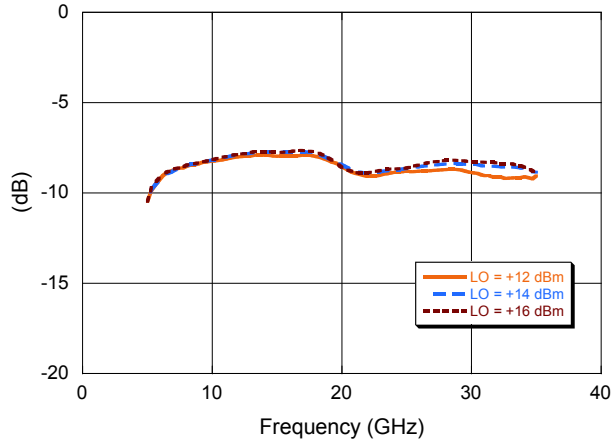

Input IP2 vs. LO Drive

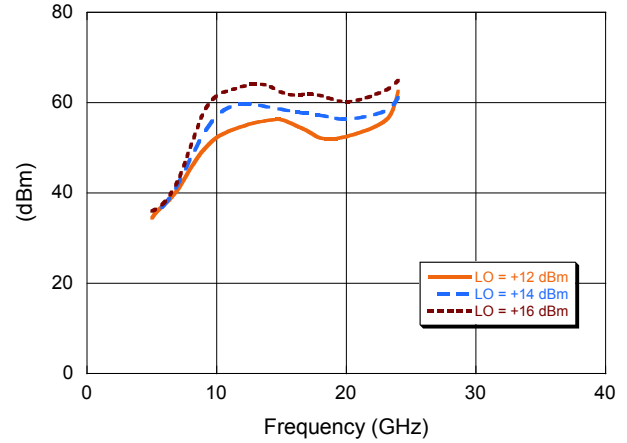

Input P1dB vs. LO Drive

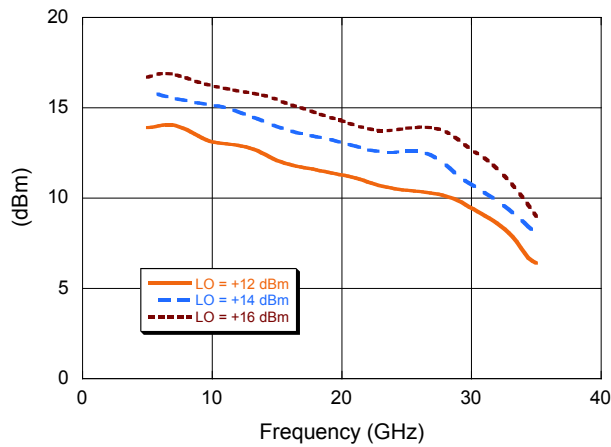

Input IP3 vs. LO Drive

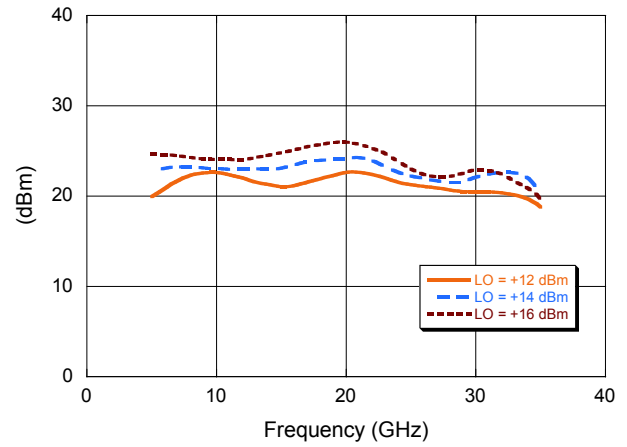

Input IP3 over Temperature, V_D = 0.5 V

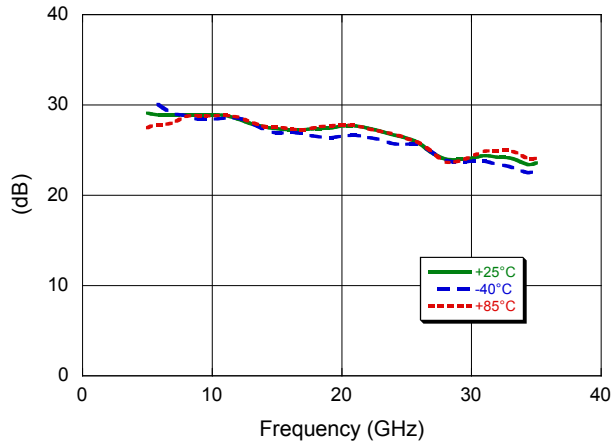

Input IP3 vs. Optional V_D

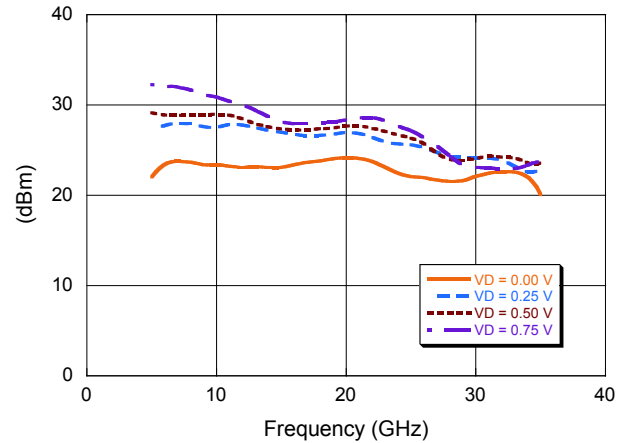

High Linearity Mixer 5 - 35 GHz

Rev. V1

Typical Performance Curves: Down Conversion,
 $T_A = +25^\circ\text{C}$, $R_F = -20\text{ dBm}$, $LO = 14\text{ dBm}$, $IF = 2\text{ GHz}$, $V_G = \text{open}$, $Z_O = 50\ \Omega$, (unless otherwise noted)

RF Port Return Loss vs. Frequency

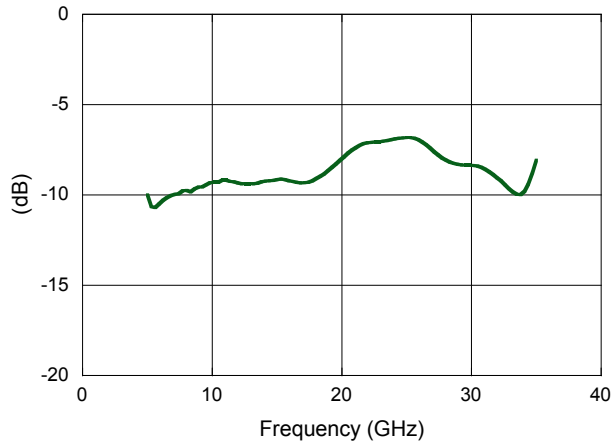

LO Port Return Loss vs. Frequency

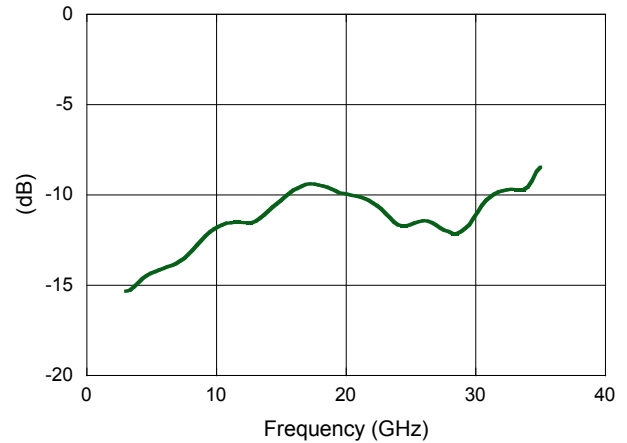

IF Port Return Loss vs. Frequency

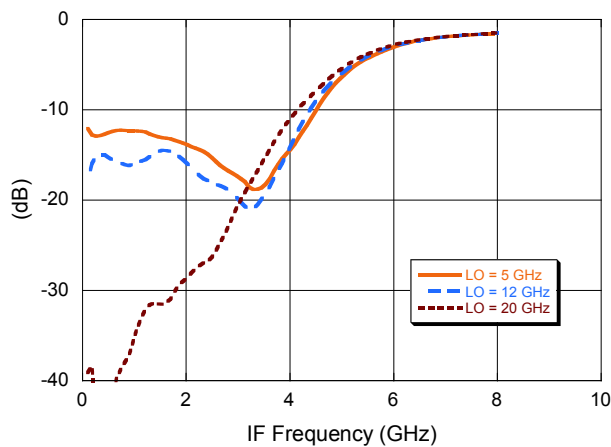

Down Conversion Gain vs. LO Drive and Optional V_G

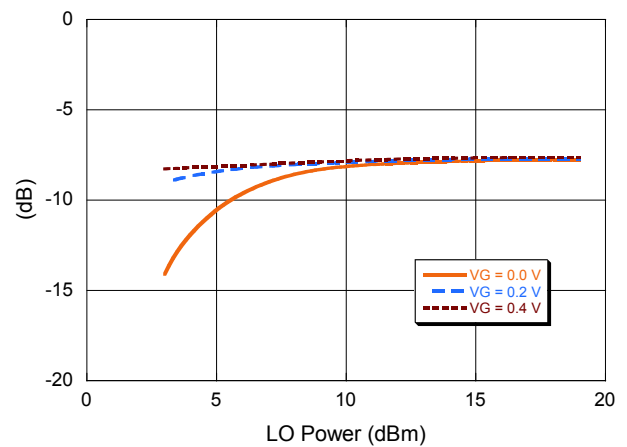

Conversion Gain, $LO = 1\text{ GHz}$, $V_G = 0.28\text{ V}$

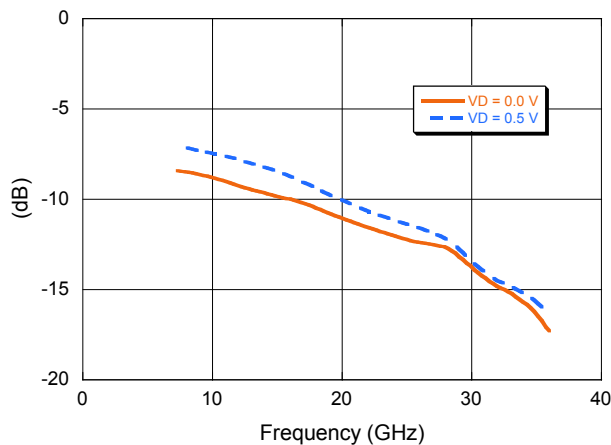

MxN Spurious Rejection at IF Port (dBc IF)

| mRF | nLO | | | | |
|-----|-----|----|----|----|----|
| | 0 | 1 | 2 | 3 | 4 |
| 0 | xx | -3 | 30 | 24 | 31 |
| 1 | 17 | 0 | 27 | 43 | 42 |
| 2 | 69 | 73 | 48 | 59 | 79 |
| 3 | 76 | 78 | 81 | 82 | 83 |
| 4 | 71 | 72 | 81 | 82 | 81 |

Lead-Free 1.5 x 1.2 mm 6-Lead TDFN[†]

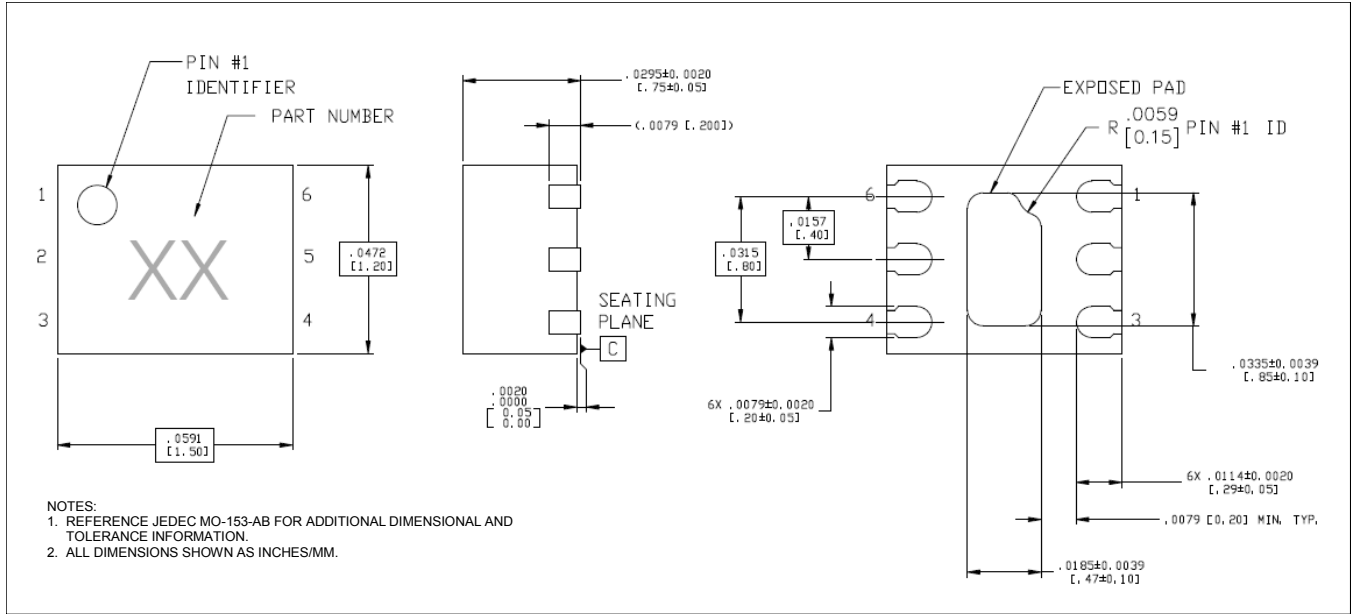

[†] Reference Application Note S2083 for lead-free solder reflow recommendations.
 Meets JEDEC moisture sensitivity level 1 requirements.
 Plating is 100% matte tin over copper.

Applications Section

System usage of this Mixer

The MAMX-011021 may be used in single ended, balanced, and image reject circuit configurations.

Single Ended Mixer

Internally the MAMX-011021 is a single ended mixer. One disadvantage of a single ended mixer is the minimal LO rejection at the IF and RF ports. Multiple MAMX-011021 mixers can be combined with baluns or 90° hybrids to produce balanced mixers or image reject mixers. Generally these configurations will have an improved IP3 and greater rejection of unwanted frequencies.

Balanced Mixer

The balanced mixer will improve mixer performance by cancelling the LO at the IF output and cancelling RF second order products. Linearity will be improved by using two mixers and RF loss will be limited to the 180° hybrid and transformer insertion losses. LO drive requirements will be increased 3dB by the need to drive a second mixer. Also, the 0° hybrid losses must be added to the LO drive. An LO buffer such as a MACOM MAAM-011100 or MAAM-011109 may be used to allow a lower power LO source.

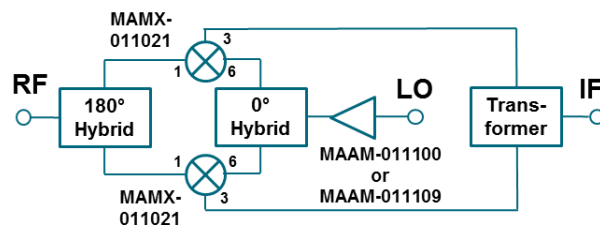
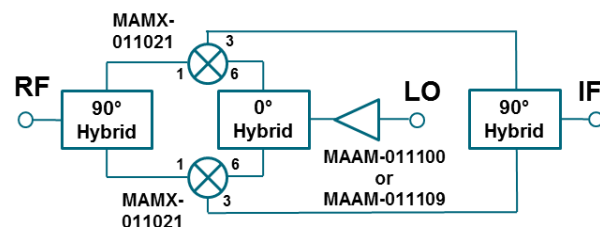

Image Reject Mixer

An image reject mixer can be constructed from two MAMX-011021 mixers, a 0° hybrid and two 90° hybrids. The connection of the IF 90° hybrid ports determines if the upper or lower sideband RF signal is passed to the IF and the corresponding IF image is rejected. Similar to the balanced mixer a 3 dB LO power increase is required because of the second mixer. Buffer amplifiers such as a MACOM MAAM-011100 or MAAM-011109 may be used to provide the additional power.



Данный компонент на территории Российской Федерации

Вы можете приобрести в компании MosChip.

Для оперативного оформления запроса Вам необходимо перейти по данной ссылке:

<http://moschip.ru/get-element>

Вы можете разместить у нас заказ для любого Вашего проекта, будь то серийное производство или разработка единичного прибора.

В нашем ассортименте представлены ведущие мировые производители активных и пассивных электронных компонентов.

Нашей специализацией является поставка электронной компонентной базы двойного назначения, продукции таких производителей как XILINX, Intel (ex.ALTERA), Vicor, Microchip, Texas Instruments, Analog Devices, Mini-Circuits, Amphenol, Glenair.

Сотрудничество с глобальными дистрибьюторами электронных компонентов, предоставляет возможность заказывать и получать с международных складов практически любой перечень компонентов в оптимальные для Вас сроки.

На всех этапах разработки и производства наши партнеры могут получить квалифицированную поддержку опытных инженеров.

Система менеджмента качества компании отвечает требованиям в соответствии с ГОСТ Р ИСО 9001, ГОСТ РВ 0015-002 и ЭС РД 009

Офис по работе с юридическими лицами:

105318, г.Москва, ул.Щербаковская д.3, офис 1107, 1118, ДЦ «Щербаковский»

Телефон: +7 495 668-12-70 (многоканальный)

Факс: +7 495 668-12-70 (доб.304)

E-mail: info@moschip.ru

Skype отдела продаж:

moschip.ru

moschip.ru_4

moschip.ru_6

moschip.ru_9