

## Features

- High Performance, High Density Programmable Logic Device
  - Typical 7 ns Pin-to-Pin Delay
  - Fully Connected Logic Array With 416 Product Terms
- Flexible Output Macrocell
  - 48 Flip-Flops - Two per Macrocell
  - 72 Sum Terms
  - All Flip-Flops, I/O Pins Feed In Independently
  - Achieves Over 80% Gate Utilization
- Enhanced Macrocell Configuration Selections
  - D- or T-Type Flip-Flops
  - Product Term or Direct Input Pin Clocking
  - Registered or Combinatorial Internal Feedback
- Several Power Saving Options

| Device     | I <sub>CC</sub> , Stand-By |
|------------|----------------------------|
| ATV2500B   | 110 mA                     |
| ATV2500BQ  | 30 mA                      |
| ATV2500BL  | 2 mA                       |
| ATV2500BQL | 2 mA                       |

- Backward Compatible With ATV2500H/L Software
- Proven and Reliable High Speed UV EPROM Process
- Reprogrammable - Tested 100% for Programmability
- 40-Pin Dual-In-Line and 44-Pin Lead Surface Mount Packages

## Block Diagram

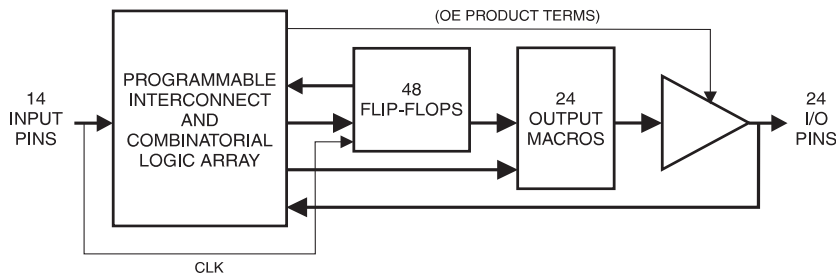

## Pin Configurations

| Pin Name    | Function              |
|-------------|-----------------------|
| IN          | Logic Inputs          |
| CLK/IN      | Pin Clock and Input   |
| I/O         | Bidirectional Buffers |
| I/O 0,2,4.. | "Even" I/O Buffers    |
| I/O 1,3,5.. | "Odd" I/O Buffers     |
| GND         | Ground                |
| VCC         | +5V Supply            |

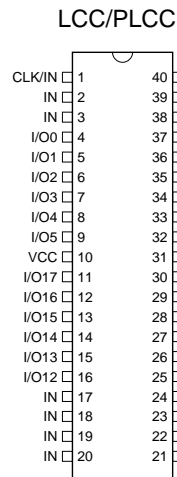
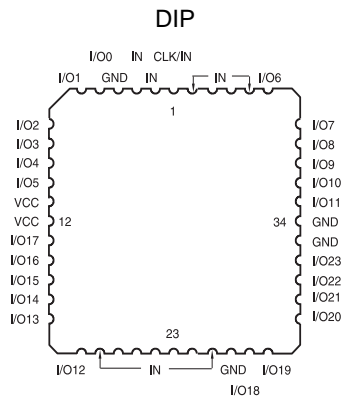

Note: For ATV2500BQ and ATV2500BQL (PLCC/LCC package only) pin 4 and pin 26 connections are not required.



**High-Speed  
High-Density  
UV Erasable  
Programmable  
Logic Device**

**ATV2500B**





# Functional Logic Diagram ATV2500B

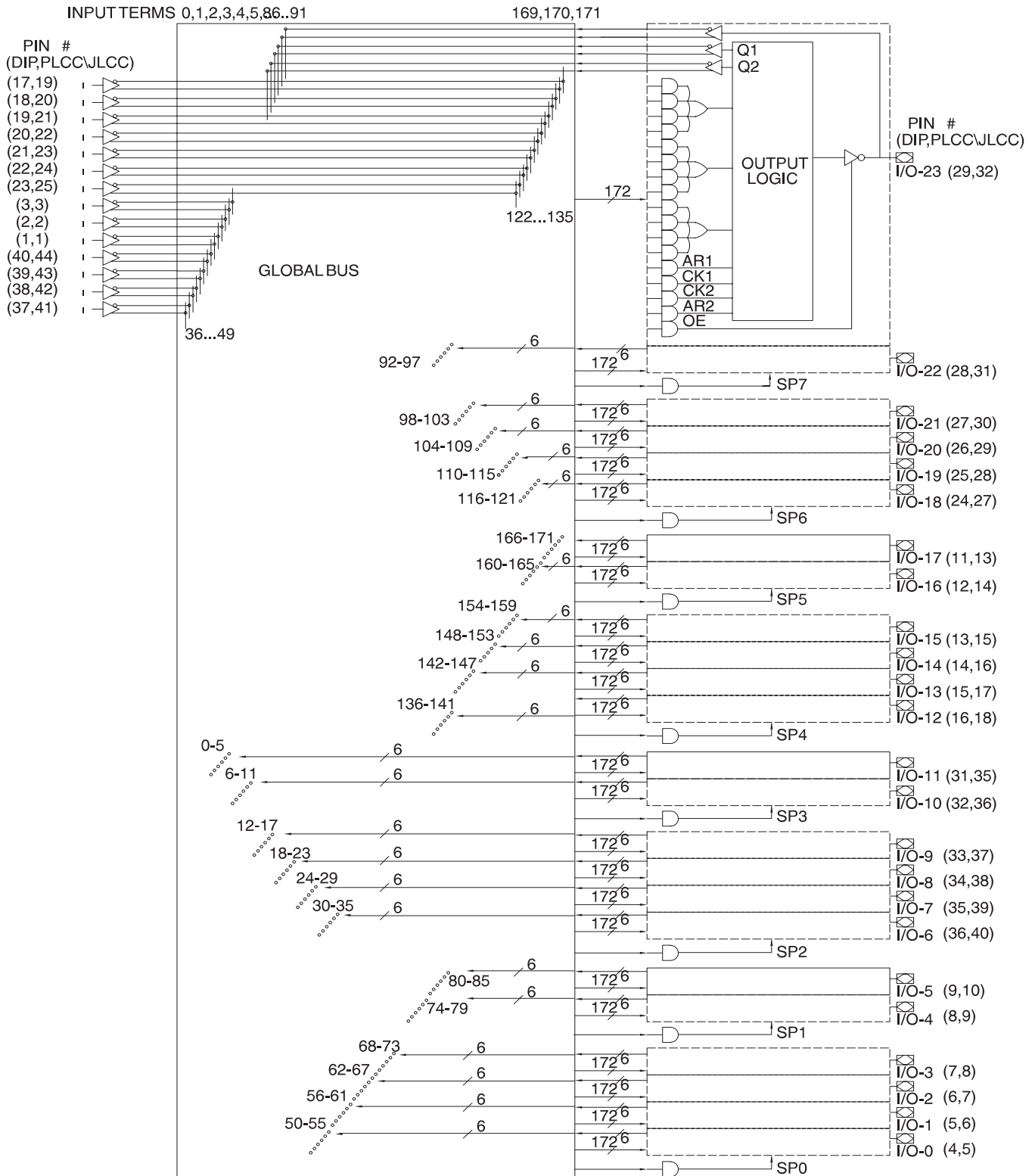

Note: 1. Not required for PLCC versions of ATV2500BQ or ATV2500BQL, making them compatible with ATV2500H and ATV2500L pinout.

## Description

The ATV2500Bs are the highest density PLDs available in a 40- or 44-pin package. With their fully connected logic array and flexible macrocell structure, high gate utilization is easily obtainable.

The ATV2500Bs are organized around a *single universal and-or array*. All pin and feedback terms are always available to every macrocell. Each of the 38 logic pins are array inputs, as are the outputs of each flip-flop.

In the ATV2500Bs, four product terms are input to each sum term. Furthermore, each macrocell's three sum terms can be combined to provide up to 12 product terms per sum term with *no performance penalty*. Each flip-flop is individually selectable to be either D- or T-type, providing further logic compaction. Also, 24 of the flip-flops may be bypassed to provide internal combinatorial feedback to the logic array.

Product terms provide individual clocks and asynchronous resets for each flip-flop. The flip-flops may also be individually configured to have direct input pin clocking. Each output has its own enable product term. Eight synchronous preset product terms serve local groups of either four or eight flip-flops. Register preload functions are provided to simplify testing. All registers automatically reset upon power up.

Several low power device options allow selection of the optimum solution for many power-sensitive applications. Each of the options significantly reduces total system power and enhances system reliability.

## Functional Logic Diagram Description

The ATV2500B functional logic diagram describes the interconnections between the input, feedback pins and logic cells. All interconnections are routed through the single global bus.

The ATV2500Bs are straightforward and uniform PLDs. The 24 macrocells are numbered 0 through 23. Each macrocell contains 17 AND gates. All AND gates have 172 inputs. The five lower product terms provide AR1, CK1, CK2, AR2, and OE. These are: one asynchronous reset and clock per flip-flop, and an output enable. The top 12 product terms are grouped into three sum terms, which are used as shown in the macrocell diagrams.

Eight synchronous preset terms are distributed in a 2/4 pattern. The first four macrocells share Preset 0, the next two share Preset 1, and so on, ending with the last two macrocells sharing Preset 7.

The 14 dedicated inputs and their complements use the numbered positions in the global bus as shown. Each macrocell provides six inputs to the global bus: (left to right) feedback F2<sup>(1)</sup> true and false, flip-flop Q1 true and false, and the pin true and false. The positions occupied by these signals in the global bus are the six numbers in the bus diagram next to each macrocell.

Note: 1. Either the flip-flop input (D/T2) or output (Q2) may be fed back in the ATV2500Bs.

## Absolute Maximum Ratings\*

|  |                                |
|--|--------------------------------|
| Temperature Under Bias.....  | -55°C to +125°C                |
| Storage Temperature .....  | -65°C to +150°C                |
| Voltage on Any Pin with Respect to Ground .....                      | -2.0V to +7.0V <sup>(1)</sup>  |
| Voltage on Input Pins with Respect to Ground During Programming..... | -2.0V to +14.0V <sup>(1)</sup> |
| Programming Voltage with Respect to Ground .....                     | -2.0V to +14.0V <sup>(1)</sup> |
| Integrated UV Erase Dose.....  | 7258 W·sec/cm <sup>2</sup>     |

\*NOTICE: Stresses beyond those listed under “Absolute Maximum Ratings” may cause permanent damage to the device. This is a stress rating only and functional operation of the device at these or any other conditions beyond those indicated in the operational sections of this specification is not implied. Exposure to absolute maximum rating conditions for extended periods may affect device reliability.

Note: 1. Minimum voltage is -0.6V dc which may undershoot to -2.0V for pulses of less than 20ns. Maximum output pin voltage is  $V_{CC} + 0.75V$  dc which may overshoot to +7.0V for pulses of less than 20ns.

## DC and AC Operating Conditions

|                              | Commercial | Industrial   | Military      |
|------------------------------|------------|--------------|---------------|
| Operating Temperature (Case) | 0°C - 70°C | -40°C - 85°C | -55°C - 125°C |
| V <sub>CC</sub> Power Supply | 5V ± 5%    | 5V ± 10%     | 5V ± 10%      |

## Pin Capacitance (f = 1 MHz, T = 25°C)<sup>(1)</sup>

|                  | Typ | Max | Units | Conditions            |
|------------------|-----|-----|-------|-----------------------|
| C <sub>IN</sub>  | 4   | 6   | pF    | V <sub>IN</sub> = 0V  |
| C <sub>OUT</sub> | 8   | 12  | pF    | V <sub>OUT</sub> = 0V |

Note: 1. Typical values for nominal supply voltage. This parameter is only sampled and is not 100% tested.

## Output Logic, Registered<sup>(1)</sup>

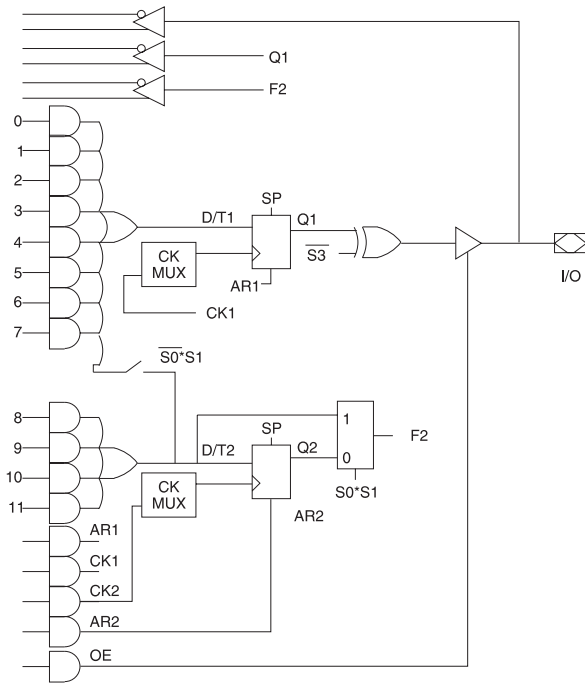

## Output Logic, Combinatorial<sup>(1)</sup>

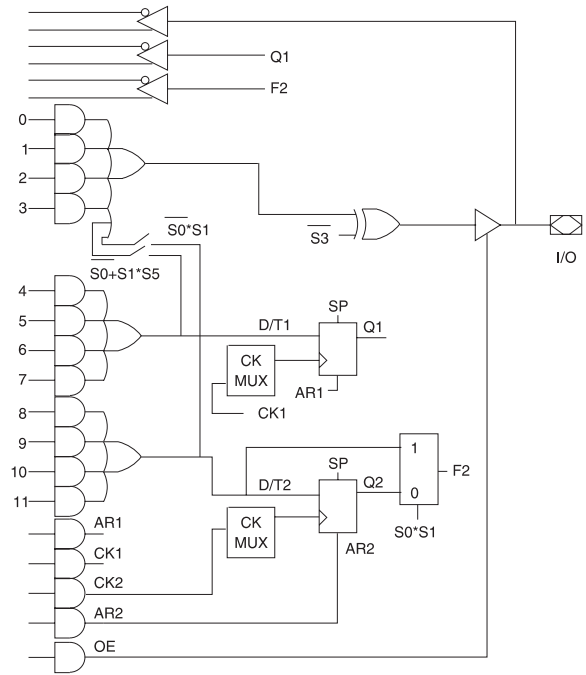

Note: 1. These diagrams show equivalent logic functions, not necessarily the actual circuit implementation.

| S2 = 0 |    | Terms in |                  | Output Configuration     |
|--------|----|----------|------------------|--------------------------|
| S1     | S0 | D/T1     | D/T2             |                          |
| 0      | 0  | 8        | 4                | Registered (Q1); Q2 FB   |
| 1      | 0  | 12       | 4 <sup>(1)</sup> | Registered (Q1); Q2 FB   |
| 1      | 1  | 8        | 4                | Registered (Q1); D/T2 FB |

| S3 | Output Configuration |
|----|----------------------|
| 0  | Active Low           |
| 1  | Active High          |

| S6 | Q1 CLOCK   |
|----|------------|
| 0  | CK1        |
| 1  | CK1 • PIN1 |

| S4 | Register 1 Type |
|----|-----------------|
| 0  | D               |
| 1  | T               |

| S7 | Q2 CLOCK   |
|----|------------|
| 0  | CK2        |
| 1  | CK2 • PIN1 |

| S5 | Register 2 Type |
|----|-----------------|
| 0  | D               |
| 1  | T               |

| S2 = 1 |    |    | Terms in         |                  | Output Configuration             |
|--------|----|----|------------------|------------------|----------------------------------|
| S5     | S1 | S0 | D/T1             | D/T2             |                                  |
| X      | 0  | 0  | 4 <sup>(1)</sup> | 4                | Combinatorial (8 Terms); Q2 FB   |
| X      | 0  | 1  | 4                | 4                | Combinatorial (4 Terms); Q2 FB   |
| X      | 1  | 0  | 4 <sup>(1)</sup> | 4 <sup>(1)</sup> | Combinatorial (12 Terms); Q2 FB  |
| 1      | 1  | 1  | 4 <sup>(1)</sup> | 4                | Combinatorial (8 Terms); D/T2 FB |
| 0      | 1  | 1  | 4                | 4                | Combinatorial (4 Terms); D/T2 FB |

Note: 1. These four terms are shared with D/T1.

## Clock Option

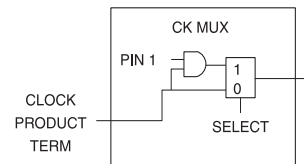

## DC Characteristics

| Symbol   | Parameter                     | Condition   | Min                | Typ        | Max             | Units   |     |    |
|----------|-------------------------------|---|--------------------|------------|-----------------|---------|-----|----|
| $I_{IL}$ | Input Load Current            | $V_{IN} = -0.1V$ to $V_{CC} + 1V$   |                    |            | 10              | $\mu A$ |     |    |
| $I_{LO}$ | Output Leakage Current        | $V_{OUT} = -0.1V$ to $V_{CC} + 0.1V$  |                    |            | 10              | $\mu A$ |     |    |
| $I_{CC}$ | Power Supply Current, Standby | $V_{CC} = MAX,$<br>$V_{IN} = GND$ or<br>$V_{CC} f = 0$ MHz,<br>Outputs Open | ATV2500B           | Com.       |                 | 110     | 190 | mA |
|          |                               |   |                    | Ind., Mil. |                 | 110     | 210 | mA |
|          |                               |   | ATV2500BQ          | Com.       |                 | 30      | 70  | mA |
|          |                               |   |                    | Ind., Mil. |                 | 30      | 85  | mA |
|          |                               |   | ATV2500BL          | Com.       |                 | 2       | 5   | mA |
|          |                               |   |                    | Ind., Mil. |                 | 2       | 10  | mA |
|          |                               |   | ATV2500BQL         | Com.       |                 | 2       | 4   | mA |
|          |                               |   |                    | Ind., Mil. |                 | 2       | 5   | mA |
| $I_{OS}$ | Output Short Circuit Current  | $V_{OUT} = 0.5V$  |                    |            | -120            | mA      |     |    |
| $V_{IL}$ | Input Low Voltage             | $MIN \leq V_{CC} \leq MAX$  | -0.6               |            | 0.8             | V       |     |    |
| $V_{IH}$ | Input High Voltage            |   | 2.0                |            | $V_{CC} + 0.75$ | V       |     |    |
| $V_{OL}$ | Output Low Voltage            | $V_{IN} = V_{IH}$ or $V_{IL},$<br>$V_{CC} = 4.5V$                           | $I_{OL} = 8$ mA    | Com., Ind. |                 | 0.5     | V   |    |
|          |                               |   | $I_{OL} = 6$ mA    | Mil.       |                 | 0.5     | V   |    |
| $V_{OH}$ | Output High Voltage           | $V_{CC} = MIN$  | $I_{OH} = -4.0$ mA |            | $V_{CC} - 0.3$  |         | V   |    |
|          |                               |   | $I_{OH} = -4.0$ mA |            | 2.4             |         |     |    |

Note: 1. See  $I_{CC}$  versus frequency characterization curves.

## AC Waveforms<sup>(1)</sup> Input Pin Clock

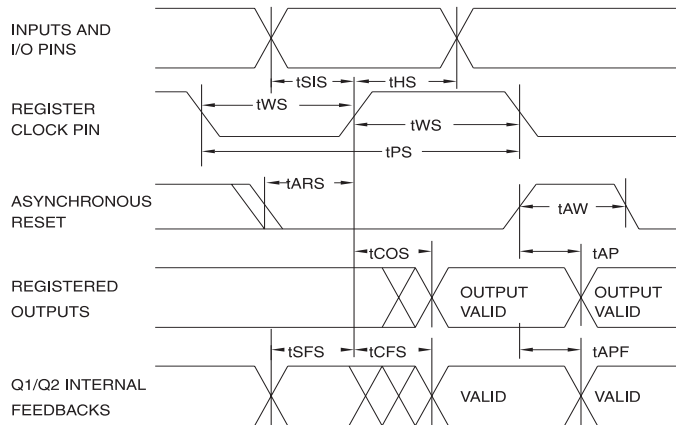

## AC Waveforms<sup>(1)</sup> Product Term Clock

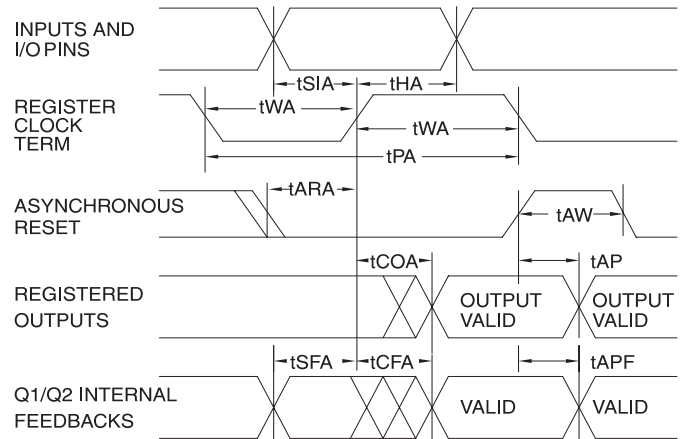

Note: 1. Timing measurement reference is 1.5V. Input AC driving levels are 0.0V and 3.0V, unless otherwise specified.

## Register AC Characteristics, Input Pin Clock

| Symbol     | Parameter                                 | -12 |     | -15 |     | -20 |     | -25 |     | -30 |     | Units |
|------------|---|-----|-----|-----|-----|-----|-----|-----|-----|-----|-----|-------|
|            |   | Min | Max | Min | Max | Min | Max | Min | Max | Min | Max |       |
| $t_{COS}$  | Clock to Output                           |     | 7.5 |     | 10  |     | 11  |     | 12  |     | 15  | ns    |
| $t_{CFS}$  | Clock to Feedback                         | 0   | 4   | 0   | 5   | 0   | 6   | 0   | 7   | 0   | 8   | ns    |
| $t_{SIS}$  | Input Setup Time                          | 7   |     | 9   |     | 14  |     | 20  |     | 23  |     | ns    |
| $t_{SFS}$  | Feedback Setup Time                       | 7   |     | 9   |     | 14  |     | 20  |     | 23  |     | ns    |
| $t_{HS}$   | Hold Time                                 | 0   |     | 0   |     | 0   |     | 0   |     | 0   |     | ns    |
| $t_{WS}$   | Clock Width                               | 5   |     | 6   |     | 7   |     | 8   |     | 9   |     | ns    |
| $t_{PS}$   | Clock Period                              | 10  |     | 12  |     | 14  |     | 16  |     | 18  |     | ns    |
| $F_{MAXS}$ | External Feedback $1/(t_{SIS} + t_{COS})$ |     | 69  |     | 52  |     | 40  |     | 31  |     | 26  | MHz   |
|            | Internal Feedback $1/(t_{SFS} + t_{CFS})$ |     | 90  |     | 71  |     | 50  |     | 37  |     | 32  | MHz   |
|            | No Feedback $1/(t_{PS})$                  |     | 100 |     | 83  |     | 71  |     | 62  |     | 55  | MHz   |
| $t_{ARS}$  | Asynchronous Reset/Pre-set Recovery Time  | 7   |     | 12  |     | 15  |     | 20  |     | 25  |     | ns    |

## Register AC Characteristics, Product Term Clock

| Symbol     | Parameter                                 | -12 |      | -15 |     | -20 |     | -25 |     | -30 |     | Units |
|------------|---|-----|------|-----|-----|-----|-----|-----|-----|-----|-----|-------|
|            |   | Min | Max  | Min | Max | Min | Max | Min | Max | Min | Max |       |
| $t_{COA}$  | Clock to Output                           |     | 12   |     | 15  |     | 20  |     | 22  |     | 25  | ns    |
| $t_{CFA}$  | Clock to Feedback                         | 3   | 7    | 5   | 12  | 10  | 16  | 12  | 18  | 13  | 20  | ns    |
| $t_{SIA}$  | Input Setup Time                          | 4   |      | 5   |     | 10  |     | 15  |     | 19  |     | ns    |
| $t_{SFA}$  | Feedback Setup Time                       | 4   |      | 5   |     | 8   |     | 10  |     | 10  |     | ns    |
| $t_{HA}$   | Hold Time                                 | 3   |      | 5   |     | 10  |     | 12  |     | 13  |     | ns    |
| $t_{WA}$   | Clock Width                               | 5.5 |      | 7.5 |     | 11  |     | 14  |     | 15  |     | ns    |
| $t_{PA}$   | Clock Period                              | 11  |      | 15  |     | 22  |     | 28  |     | 30  |     | ns    |
| $F_{MAXA}$ | External Feedback $1/(t_{SIA} + t_{COA})$ |     | 62.5 |     | 50  |     | 33  |     | 27  |     | 23  | MHz   |
|            | Internal Feedback $1/(t_{SFA} + t_{CFA})$ |     | 90   |     | 58  |     | 38  |     | 36  |     | 24  | MHz   |
|            | No Feedback $1/(t_{PS})$                  |     | 90   |     | 66  |     | 45  |     | 36  |     | 33  | MHz   |
| $t_{ARA}$  | Asynchronous Reset/Preset Recovery Time   | 3   |      | 8   |     | 12  |     | 15  |     | 18  |     | ns    |

## AC Waveforms<sup>(1)</sup> Combinatorial Outputs and Feedback

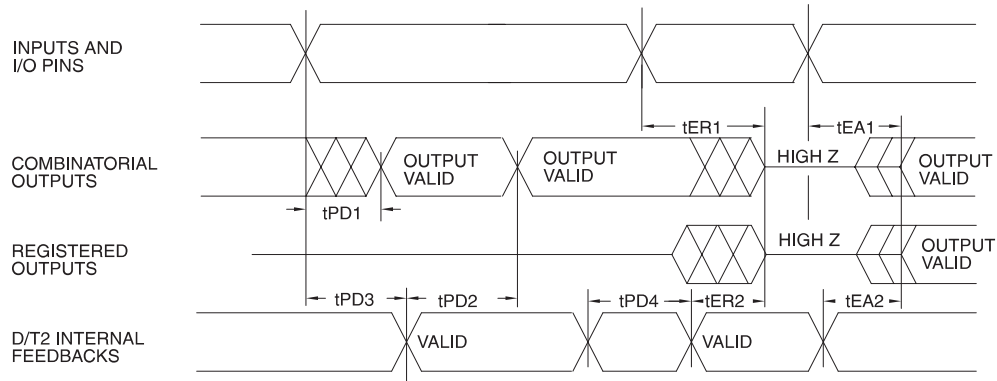

Note: 1. Timing measurement reference is 1.5V. Input AC driving levels are 0.0V and 3.0V, unless otherwise specified.



## AC Characteristics

| Symbol    | Parameter                                 | -12 |     | -15 |     | -20 |     | -25 |     | -30 |     | Units |
|-----------|---|-----|-----|-----|-----|-----|-----|-----|-----|-----|-----|-------|
|           |   | Min | Max | Min | Max | Min | Max | Min | Max | Min | Max |       |
| $t_{PD1}$ | Input to Non-Registered Output            |     | 12  |     | 15  |     | 20  |     | 25  |     | 30  | ns    |
| $t_{PD2}$ | Feedback to Non-Registered Output         |     | 12  |     | 15  |     | 20  |     | 25  |     | 30  | ns    |
| $t_{PD3}$ | Input to Non-Registered Feedback          |     | 8   |     | 11  |     | 15  |     | 18  |     | 20  | ns    |
| $t_{PD4}$ | Feedback to Non-Registered Feedback       |     | 8   |     | 11  |     | 15  |     | 18  |     | 20  | ns    |
| $t_{EA1}$ | Input to Output Enable                    |     | 12  |     | 15  |     | 20  |     | 25  |     | 30  | ns    |
| $t_{ER1}$ | Input to Output Disable                   |     | 12  |     | 15  |     | 20  |     | 25  |     | 30  | ns    |
| $t_{EA2}$ | Feedback to Output Enable                 |     | 12  |     | 15  |     | 20  |     | 25  |     | 30  | ns    |
| $t_{ER2}$ | Feedback to Output Disable                |     | 12  |     | 15  |     | 20  |     | 25  |     | 30  | ns    |
| $t_{AW}$  | Asynchronous Reset Width                  | 6   |     | 8   |     | 12  |     | 15  |     | 18  |     | ns    |
| $t_{AP}$  | Asynchronous Reset to Registered Output   |     | 15  |     | 18  |     | 22  |     | 28  |     | 30  | ns    |
| $t_{APF}$ | Asynchronous Reset to Registered Feedback |     | 12  |     | 15  |     | 19  |     | 25  |     | 30  | ns    |

### Input Test Waveforms and Measurement Levels

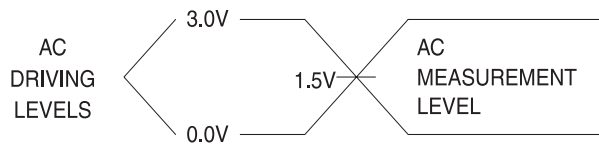

### Output Test Load

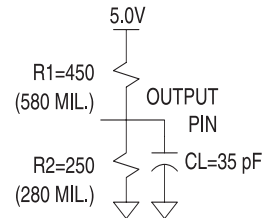

### Preload and Observability of Registered Outputs

The ATV2500Bs registers are provided with circuitry to allow loading of each register asynchronously with either a high or a low. This feature will simplify testing since any state can be forced into the registers to control test sequencing. A  $V_{IH}$  level on the odd I/O pins will force the appropriate register high; a  $V_{IL}$  will force it low, independent of the polarity or other configuration bit settings.

The PRELOAD state is entered by placing an 10.25V to 10.75V signal on SMP lead 42. When the preload clock

SMP lead 23 is pulsed high, the data on the I/O pins is placed into the 12 registers chosen by the Q select and even/odd select pins.

Register 2 observability mode is entered by placing an 10.25V to 10.75V signal on pin/lead 2. In this mode, the contents of the buried register bank will appear on the associated outputs when the OE control signals are active.

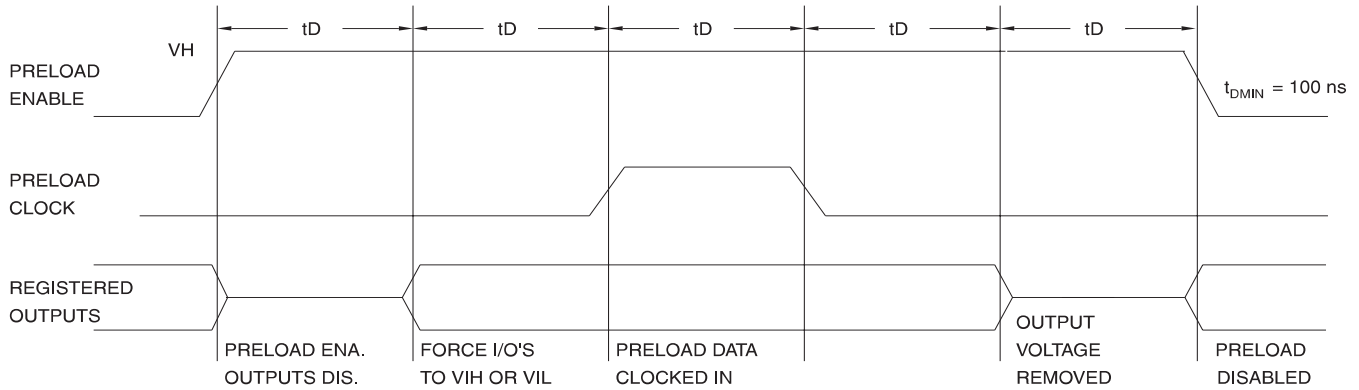

| Level forced on Odd I/O pin during PRELOAD cycle | Q Select Pin State | Even/Odd Select | Even Q1 state after cycle | Even Q2 state after cycle | Odd Q1 state after cycle | Odd Q2 state after cycle |
|--|--------------------|-----------------|---------------------------|---------------------------|--------------------------|--------------------------|
| $V_{IH}/V_{IL}$                                  | Low                | Low             | High/Low                  | X                         | X                        | X                        |
| $V_{IH}/V_{IL}$                                  | High               | Low             | X                         | High/Low                  | X                        | X                        |
| $V_{IH}/V_{IL}$                                  | Low                | High            | X                         | X                         | High/Low                 | X                        |
| $V_{IH}/V_{IL}$                                  | High               | High            | X                         | X                         | X                        | High/Low                 |

## Power-Up Reset

The registers in the ATV2500Bs are designed to reset during power up. At a point delayed slightly from  $V_{CC}$  crossing  $V_{RST}$ , all registers will be reset to the low state. The output state will depend on the polarity of the output buffer.

This feature is critical for state as nature of reset and the uncertainty of how  $V_{CC}$  actually rises in the system, the following conditions are required:

1. The  $V_{CC}$  rise must be monotonic,
2. After reset occurs, all input and feedback setup times must be met before driving the clock pin or terms high, and
3. The clock pin, and any signals from which clock terms are derived, must remain stable during  $t_{PR}$ .

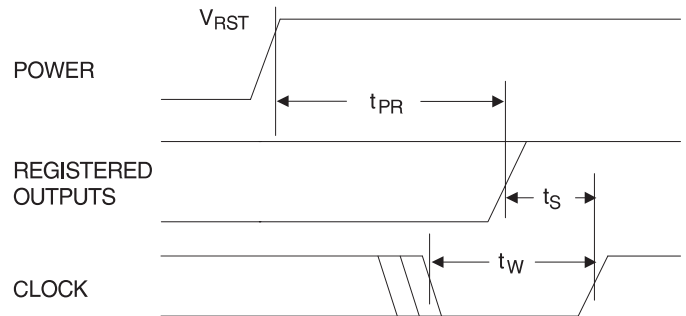

| Parameter | Description            | Typ | Max  | Units |
|-----------|------------------------|-----|------|-------|
| $t_{PR}$  | Power-Up Reset Time    | 600 | 1000 | ns    |
| $V_{RST}$ | Power-Up Reset Voltage | 3.8 | 4.5  | V     |

## Security Fuse Usage

A single fuse is provided to prevent unauthorized copying of ATV2500B fuse patterns. Once programmed, the outputs will read programmed during verify. The security fuse should be programmed last, as its effect is immediate.

The security fuse also inhibits Preload and Q2 observability.

## Atmel CMOS PLDs

The ATV2500Bs utilize an advanced 0.65-micron CMOS EPROM technology. This technology's state of the art features are the optimum combination for PLDs:

- CMOS technology provides high speed, low power, and high noise immunity.
- EPROM technology is the most cost effective method for producing PLDs - surpassing bipolar fusible link technology in low cost, while providing the necessary reprogrammability.
- EPROM reprogrammability, which is 100% tested before shipment, provides inherently better programmability and reliability than one-time fusible PLDs.

## Using the ATV2500Bs Many Advanced Features

The ATV2500Bs advanced flexibility packs more usable gates into 44 leads than other PLDs. Some of the ATV2500Bs key features are:

- Fully Connected Logic Array -

Each array input is always available to every product term. This makes logic placement a breeze.

- Selectable D- and T-Type Registers -

Each ATV2500B flip-flop can be individually configured as either D- or T-type. Using the T-type configuration, JK and SR flip-flops are also easily created. These options allow more efficient product term usage.

- Buried Combinatorial Feedback -

Each macrocell's Q2 register may be bypassed to feed its input (D/T2) directly back to the logic array. This provides further logic expansion capability without using precious pin resources.

- Selectable Synchronous/Asynchronous Clocking -

Each of the ATV2500Bs flip-flops has a dedicated clock product term. This removes the constraint that all registers use the same clock. Buried state machines, counters and registers can all coexist in one device while running on separate clocks. Individual flip-flop clock source selection further allows mixing higher performance pin clocking and flexible product term clocking within one design.

- A Total of 48 Registers -

The ATV2500B provides two flip-flops per macrocell - a total of 48. Each register has its own clock and reset terms, as well as its own sum term.

- Independent I/O Pin and Feedback Paths -

Each I/O pin on the ATV2500B has a dedicated input path. Each of the 48 registers has its own feedback term into the array as well. These features, combined with individual product terms for each I/O's output enable, facilitate true bi-directional I/O design.

- Combinable Sum Terms -

Each output macrocell's three sum terms may be combined into a single term. This provides a fan in of up to 12 product terms per sum term with *no speed penalty*.

## Programming Software Support

As with all other Atmel PLDs, several third party PLD development software products and programmers will support the ATV2500Bs.

Several third party programmers will support the ATV2500B as well. Additionally, the ATV2500B may be programmed to perform the ATV2500H/Ls functional subset (no T-type flip-flops, pin clocking or D/T2 feedback) using the ATV2500H/L JEDEC file. In this case, the ATV2500B becomes a direct replacement or speed upgrade for the ATV2500H/L (additional GND connections are required). Please refer to the Programmable Logic Development Tools section for a complete PLD software and programmer listing.

## Erase Characteristics

The entire memory array of an ATV2500B is erased after exposure to ultraviolet light at a wavelength of 2537 Å. Complete erasure is assured after a minimum of 20 minutes exposure using 12,000  $\mu\text{W}/\text{cm}^2$  intensity lamps spaced one inch away from the chip. Minimum erase time for lamps at other intensity ratings can be calculated from the minimum integrated erasure dose of 15  $\text{W}\cdot\text{sec}/\text{cm}^2$ . To prevent unintentional erasure, an opaque label is recommended to cover the clear window on any UV erasable PLD which will be subjected to continuous fluorescent indoor lighting or sunlight.

SUPPLY CURRENT vs. INPUT FREQUENCY

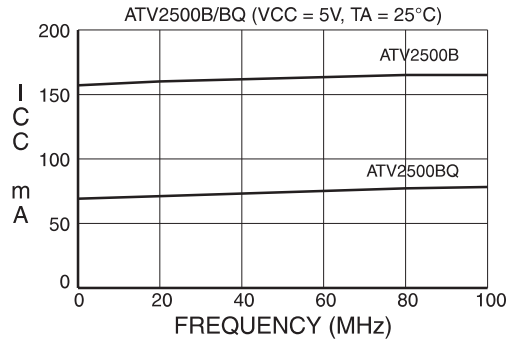

SUPPLY CURRENT vs. INPUT FREQUENCY

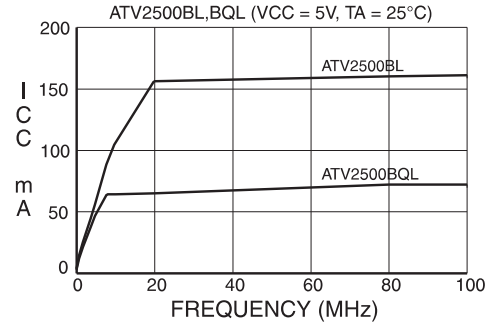

SUPPLY CURRENT vs. SUPPLY VOLTAGE

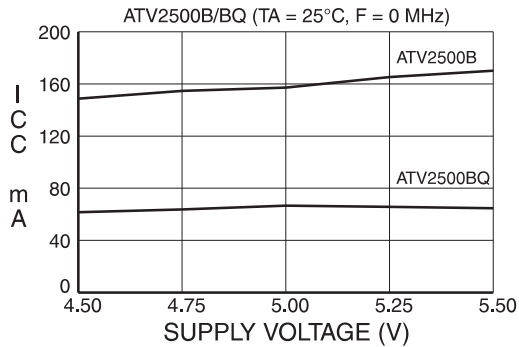

SUPPLY CURRENT vs. SUPPLY VOLTAGE

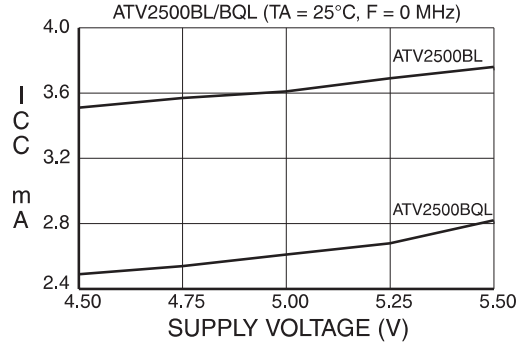

SUPPLY CURRENT vs. AMBIENT TEMPERATURE

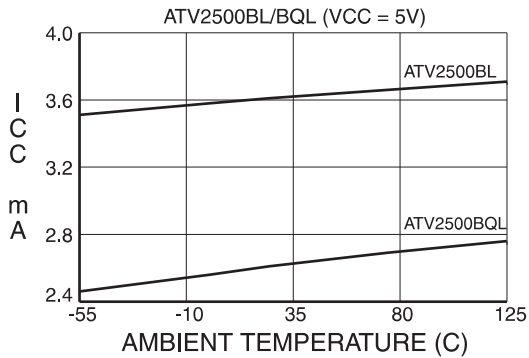

SUPPLY CURRENT vs. AMBIENT TEMPERATURE

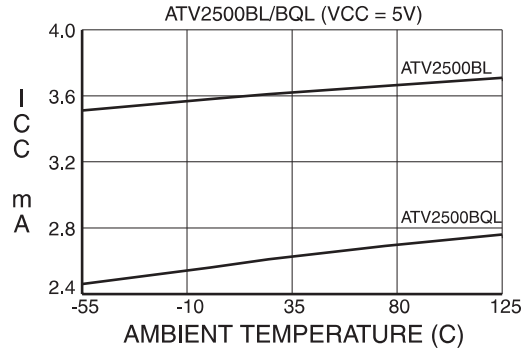

OUTPUT SOURCE CURRENT vs SUPPLY VOLTAGE

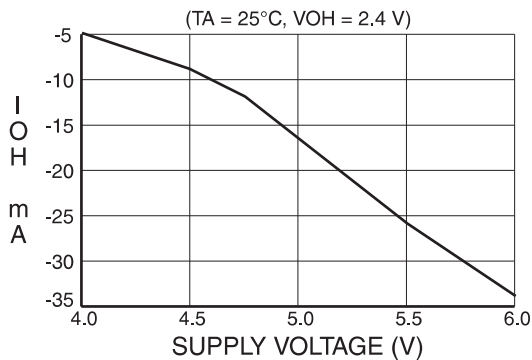

OUTPUT SINK CURRENT vs SUPPLY VOLTAGE

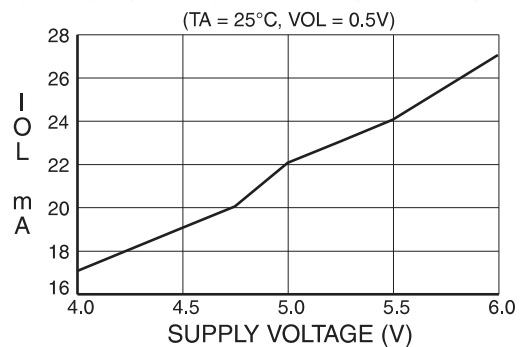

Note: 1. All normalized values referenced to maximum specification in AC Characteristics of data sheet.

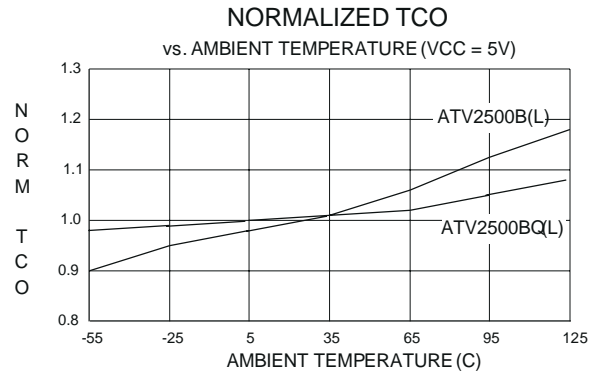
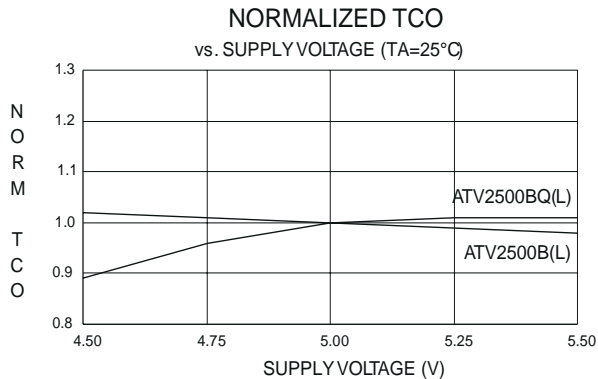
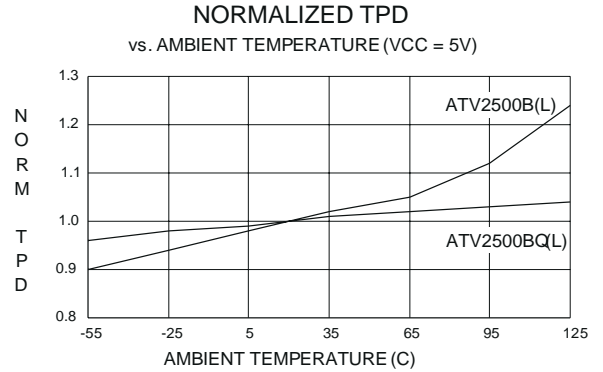
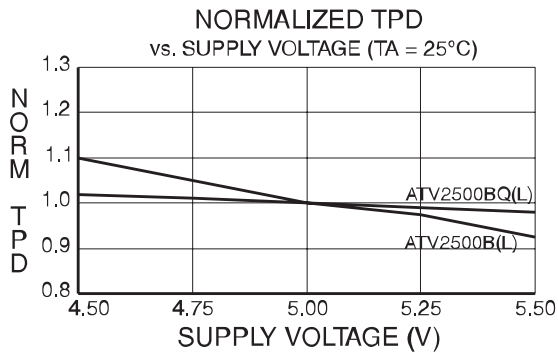
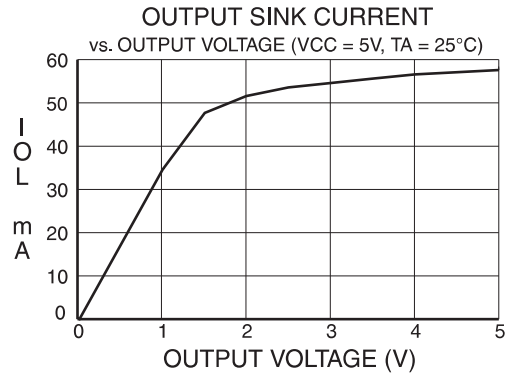
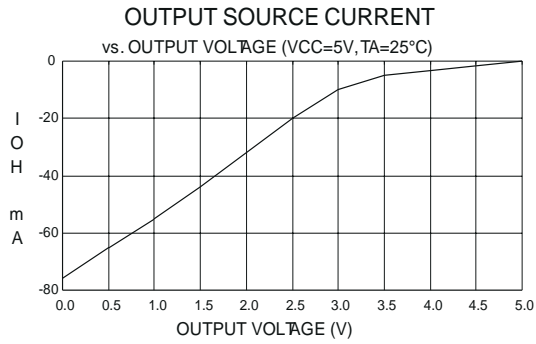
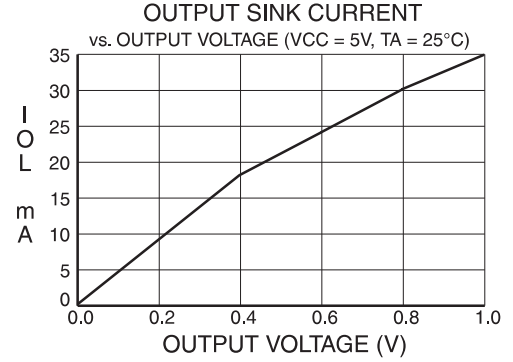
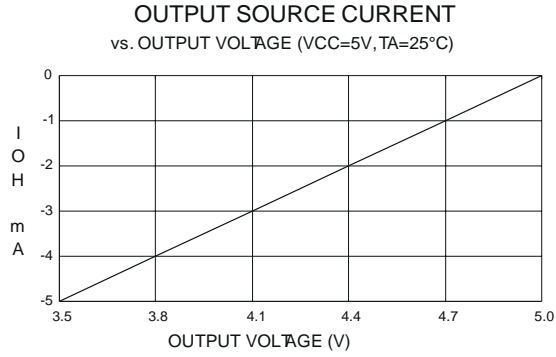

Note: 1. All normalized values referenced to maximum specification in AC Characteristics of data sheet.

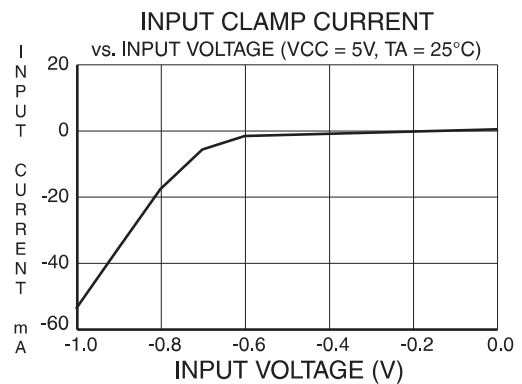
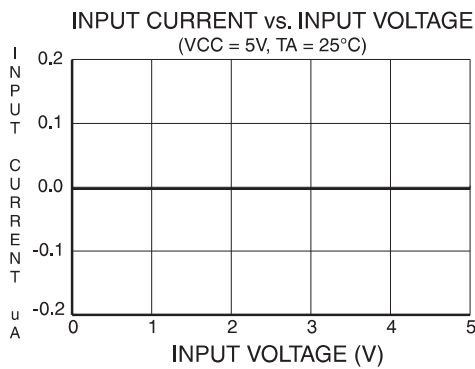
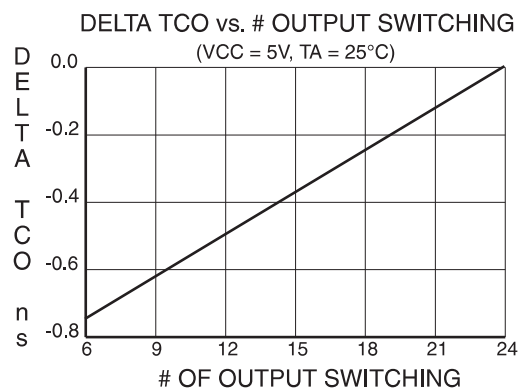
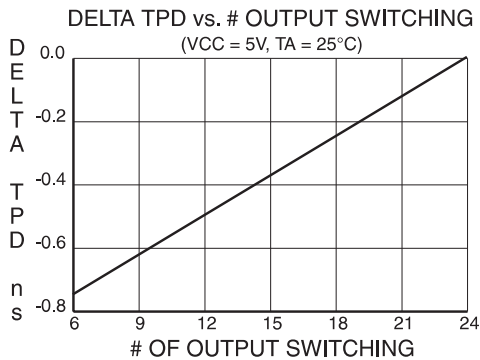
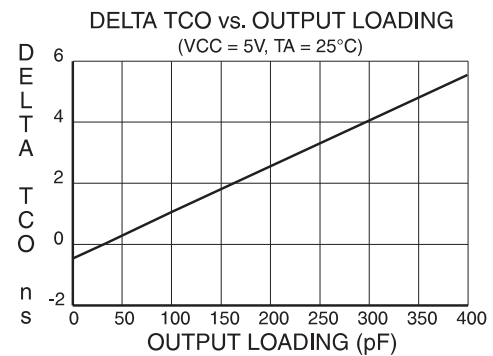
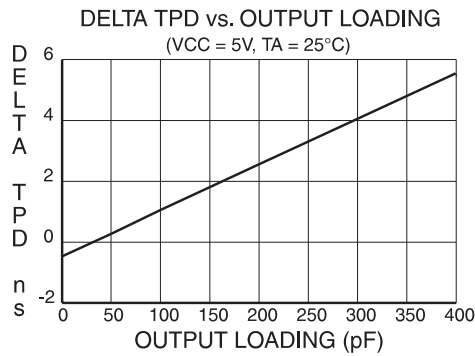
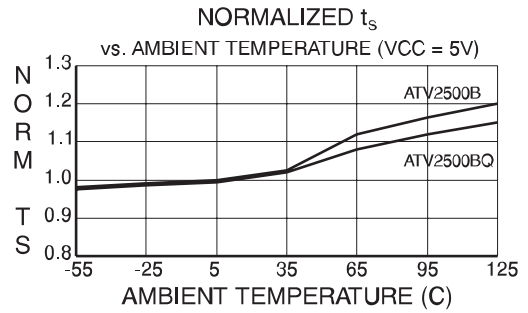
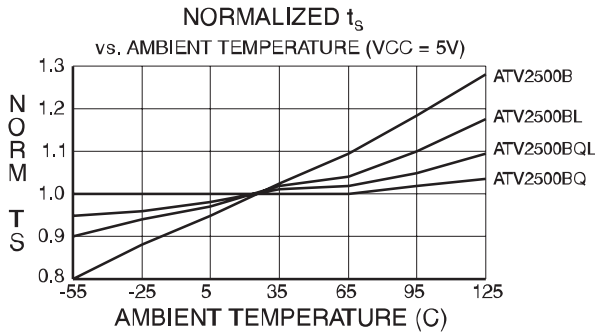

Note: 1. All normalized values referenced to maximum specification in AC Characteristics of data sheet.

## Ordering Information

| $t_{PD}$<br>(ns) | $t_{COS}$<br>(ns) | Ext. $f_{MAXS}$<br>(MHz) | Ordering Code      | Package | Operation Range   |                               |
|------------------|-------------------|--------------------------|--------------------|---------|---|-------------------------------|
| 12               | 7.5               | 69                       | ATV2500B-12JC      | 44J     | Commercial<br>(0°C to 70°C)                                   |                               |
|                  |                   |                          | ATV2500B-12KC      | 44KW    |   |                               |
| 15               | 10                | 52                       | ATV2500B-15JC      | 44J     | Commercial<br>(0°C to 70°C)                                   |                               |
|                  |                   |                          | ATV2500B-15KC      | 44KW    |   |                               |
|                  |                   |                          | ATV2500B-15JI      | 44J     | Industrial<br>(-40°C to 85°C)                                 |                               |
|                  |                   |                          | ATV2500B-15KI      | 44KW    |   |                               |
|                  |                   |                          | ATV2500B-15KM      | 44KW    | Military<br>(-55°C to 125°C)                                  |                               |
|                  |                   |                          | ATV2500B-15LM      | 44LW    |   |                               |
|                  |                   |                          | ATV2500B-15KM/883  | 44KW    | Military/883C<br>(-55°C to 125°C)<br>Class B, Fully Compliant |                               |
|                  |                   |                          | ATV2500B-15LM/883  | 44LW    |   |                               |
| 20               | 11                | 40                       | ATV2500BL-20JC     | 44J     | Commercial<br>(0°C to 70°C)                                   |                               |
|                  |                   |                          | ATV2500BL-20KC     | 44KW    |   |                               |
|                  |                   |                          | ATV2500BL-20JI     | 44J     | Industrial<br>(-40°C to 85°C)                                 |                               |
|                  |                   |                          | ATV2500BL-20KI     | 44KW    |   |                               |
|                  |                   |                          | ATV2500BL-20KM     | 44KW    | Military<br>(-55°C to 125°C)                                  |                               |
|                  |                   |                          | ATV2500BL-20LM     | 44LW    |   |                               |
|                  |                   |                          | ATV2500BL-20KM/883 | 44KW    | Military/883C<br>(-55°C to 125°C)<br>Class B, Fully Compliant |                               |
|                  |                   |                          | ATV2500BL-20LM/883 | 44LW    |   |                               |
| 20               | 11                | 40                       | ATV2500BQ-20DC     | 40DW6   | Commercial<br>(0°C to 70°C)                                   |                               |
|                  |                   |                          | ATV2500BQ-20JC     | 44J     |   |                               |
|                  |                   |                          | ATV2500BQ-20KC     | 44KW    |   |                               |
|                  |                   |                          | ATV2500BQ-20PC     | 40P6    |   |                               |
|                  |                   |                          | ATV2500BQ-25DC     | 40DW6   |   |                               |
| 25               | 12                | 31                       | ATV2500BQ-25JC     | 44J     | Commercial<br>(0°C to 70°C)                                   |                               |
|                  |                   |                          | ATV2500BQ-25KC     | 44KW    |   |                               |
|                  |                   |                          | ATV2500BQ-25PC     | 40P6    |   |                               |
|                  |                   |                          | ATV2500BQ-25DI     | 40DW6   |   | Industrial<br>(-40°C to 85°C) |
|                  |                   |                          | ATV2500BQ-25JI     | 44J     |   |                               |
|                  |                   |                          | ATV2500BQ-25KI     | 44KW    |   |                               |
|                  |                   |                          | ATV2500BQ-25PI     | 40P6    |   |                               |
|                  |                   |                          | ATV2500BQ-25DM     | 40DW6   | Military/883C<br>(-55°C to 125°C)                             |                               |
|                  |                   |                          | ATV2500BQ-25KM     | 44KW    |   |                               |
|                  |                   |                          | ATV2500BQ-25LM     | 44LW    |   |                               |
|                  |                   |                          | ATV2500BQ-25DM/883 | 40DW6   |   |                               |
|                  |                   |                          | ATV2500BQ-25KM/883 | 44KW    | Military/883C<br>(-55°C to 125°C)<br>Class B, Fully Compliant |                               |
|                  |                   |                          | ATV2500BQ-25LM/883 | 44LW    |   |                               |



## Ordering Information (Continued)

| $t_{PD}$<br>(ns) | $t_{COS}$<br>(ns) | Ext. $f_{MAXS}$<br>(MHz) | Ordering Code       | Package | Operation Range   |
|------------------|-------------------|--------------------------|---------------------|---------|---|
| 25               | 12                | 31                       | ATV2500BQL-25DC     | 40DW6   | Commercial<br>(0°C to 70°C)                                   |
|                  |                   |                          | ATV2500BQL-25JC     | 44J     |   |
|                  |                   |                          | ATV2500BQL-25KC     | 44KW    |   |
|                  |                   |                          | ATV2500BQL-25PC     | 40P6    |   |
| 25               | 12                | 31                       | ATV2500BQL-25DI     | 40DW6   | Industrial<br>(-40°C to 85°C)                                 |
|                  |                   |                          | ATV2500BQL-25JI     | 44J     |   |
|                  |                   |                          | ATV2500BQL-25KI     | 44KW    |   |
|                  |                   |                          | ATV2500BQL-25PI     | 40P6    |   |
| 30               | 15                | 26                       | ATV2500BQL-30DM     | 40DW6   | Military/883C<br>(-55°C to 125°C)                             |
|                  |                   |                          | ATV2500BQL-30KM     | 44KW    |   |
|                  |                   |                          | ATV2500BQL-30LM     | 44LW    |   |
|                  | 15                | 26                       | ATV2500BQL-30DM/883 | 40DW6   | Military/883C<br>(-55°C to 125°C)<br>Class B, Fully Compliant |
|                  |                   |                          | ATV2500BQL-30KM/883 | 44KW    |   |
|                  |                   |                          | ATV2500BQL-30LM/883 | 44LW    |   |
| 15               | 10                | 52                       | 5962 - 9154504MXX   | 44LW    | Military/883C<br>(-55°C to 125°C)<br>Class B, Fully Compliant |
|                  |                   |                          | 5962 - 9154504MYX   | 44KW    |   |
| 20               | 11                | 40                       | 5962 - 9154505MXX   | 44LW    | Military/883C<br>(-55°C to 125°C)<br>Class B, Fully Compliant |
|                  |                   |                          | 5962 - 9154505MYX   | 44KW    |   |
| 25               | 12                | 31                       | 5962 - 9154506MXX   | 44LW    | Military/883C<br>(-55°C to 125°C)<br>Class B, Fully Compliant |
|                  |                   |                          | 5962 - 9154506MYX   | 44KW    |   |
|                  |                   |                          | 5962 - 9154506MQA   | 40DW6   |   |
| 30               | 15                | 26                       | 5962 - 9154507MXX   | 44LW    | Military/883C<br>(-55°C to 125°C)<br>Class B, Fully Compliant |
|                  |                   |                          | 5962 - 9154507MYX   | 44KW    |   |
|                  |                   |                          | 5962 - 9154507MQA   | 40DW6   |   |

| Package Type |   |
|--------------|---|
| <b>40DW6</b> | 40-Lead, 0.600" Wide, Ceramic, Dual Inline Package (Cerdip)   |
| <b>44J</b>   | 44-Lead, Plastic J-Leaded Chip Carrier OTP (PLCC)             |
| <b>44KW</b>  | 44-Lead, Windowed, Ceramic J-Leaded Chip Carrier (JLCC)       |
| <b>40P6</b>  | 40-Lead, 0.600" Wide, Plastic, Dual Inline Package OTP (PDIP) |
| <b>44LW</b>  | 44-Pad, Windowed, Ceramic Leadless Chip Carrier (LCC)         |





## Packaging Information

**44LW, 44-Pad, Windowed, Ceramic Leadless Chip Carrier (LCC)**

Dimensions in Inches and (Millimeters)\*

MIL-STD-1835 C-5

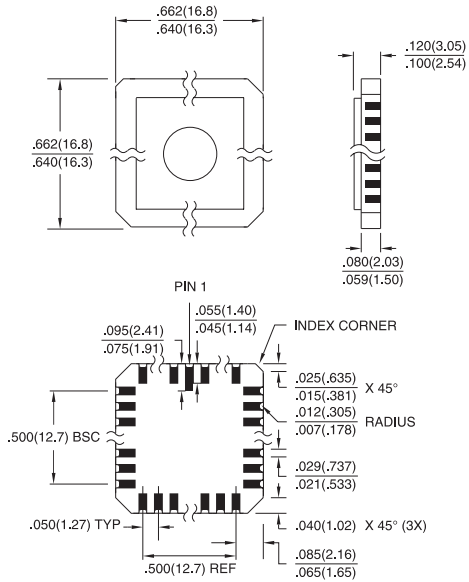

\*Controlling dimension: millimeters

## Данный компонент на территории Российской Федерации

### Вы можете приобрести в компании MosChip.

Для оперативного оформления запроса Вам необходимо перейти по данной ссылке:

<http://moschip.ru/get-element>

Вы можете разместить у нас заказ для любого Вашего проекта, будь то серийное производство или разработка единичного прибора.

В нашем ассортименте представлены ведущие мировые производители активных и пассивных электронных компонентов.

Нашей специализацией является поставка электронной компонентной базы двойного назначения, продукции таких производителей как XILINX, Intel (ex.ALTERA), Vicor, Microchip, Texas Instruments, Analog Devices, Mini-Circuits, Amphenol, Glenair.

Сотрудничество с глобальными дистрибьюторами электронных компонентов, предоставляет возможность заказывать и получать с международных складов практически любой перечень компонентов в оптимальные для Вас сроки.

На всех этапах разработки и производства наши партнеры могут получить квалифицированную поддержку опытных инженеров.

Система менеджмента качества компании отвечает требованиям в соответствии с ГОСТ Р ИСО 9001, ГОСТ РВ 0015-002 и ЭС РД 009

### Офис по работе с юридическими лицами:

105318, г.Москва, ул.Щербаковская д.3, офис 1107, 1118, ДЦ «Щербаковский»

Телефон: +7 495 668-12-70 (многоканальный)

Факс: +7 495 668-12-70 (доб.304)

E-mail: [info@moschip.ru](mailto:info@moschip.ru)

Skype отдела продаж:

moschip.ru

moschip.ru\_4

moschip.ru\_6

moschip.ru\_9