

Switching Mode Power Supply ZEN-PA03024

CSM_ZEN-PA03024_DS_E_3_1

New Compact Power Supply (30 W) for ZEN Programmable Relays

- Slim size with a depth of 56 mm (W × H × D: 70 × 90 × 56 mm).
- EMI: Conforms to EN61000-6-3 (Class B).
- Allows parallel operation.
- Safety standards: UL508/UL60950-1/UL1604, CSA C22.2 No. 14/No.60950-1/No.213 (Evaluated by UL), EN60950-1 (VDE 0805 Teil 1), EN50178 (VDE0160)
- Output voltage: 24 VDC; Output current: 1.3 A; Capacity: 30 W
- Uses lead-free soldering.



 Refer to *Safety Precautions* on page 6

Model Number Structure

Model Number Legend

ZEN-PA 030 24
1 2 3

1. Unit
PA: Power supply unit
2. Power Ratings
030: 30 W
3. Output voltage
24: 24 V

Ordering Information

List of Models

| Power ratings | Input voltage | Output voltage | Output current | Model number |
|---------------|----------------|----------------|----------------|--------------|
| 30 W | 100 to 240 VAC | 24 VDC | 1.3 A | ZEN-PA03024 |

Accessories (Order Separately)

| Name | | Models |
|----------------|------------------------|-----------|
| Mounting Track | 50 cm (l) × 7.3 mm (t) | PFP-50N |
| | 1 m (l) × 7.3 mm (t) | PFP-100N |
| | 1 m (l) × 16 mm (t) | PFP-100N2 |
| End Plate | | PFP-M |
| Spacer | | PFP-S |

Specifications

■ Ratings/Characteristics

| | | | |
|----------------------|--|--|-----------------------------------|
| Efficiency (typical) | | 80% min. | |
| Input | Voltage | 100 to 240 VAC (85 to 264 VAC), 95 to 350 VDC (See note 1.) | |
| | Frequency | 50/60 Hz (47 to 450 Hz) | |
| | Current | 100 VAC input | 0.8 A max. |
| | | 200 VAC input | 0.45 A max. |
| | Leakage current | 100 VAC input | 0.4 mA max. |
| | | 200 VAC input | 0.75 mA max. |
| | Inrush current (See note 2.) | 100 VAC input | 25 A max. |
| 200 VAC input | | 50 A max. | |
| Output | Voltage adjustment range (See note 3.) | -10 to 15% (with V.ADJ) of rated output voltage | |
| | Ripple | 2% (p-p) max. (-25 to -10°C: 4% max.) | |
| | Input variation influence | 0.5% max. | |
| | Load variation influence (rated input voltage) | 1.5% max. | |
| | Temperature variation influence | 0.05%/°C max. | |
| | Start up time (See note 2.) | 1,000 ms max. (100 VAC or 200 VAC, at rated output voltage) | |
| | Hold time (See note 2.) | 15 ms min., 20 ms (typical) (100 VAC or 200 VAC, at rated output voltage) | |
| Additional functions | Overload protection (See note 2.) | 105% to 135% of rated load current, inverted L drop, intermittent, automatic reset | |
| | Parallel operation | Yes (2 units max. For details, refer to the derating curve in <i>Engineering Data</i> on page 4. For DC input, parallel operation is possible only for 110 to 350 VDC.) | |
| | Series operation | No | |
| Others | Ambient temperature | Operating: Refer to the derating curve in <i>Engineering Data</i> on page 4. (with no icing or condensation) Storage: -25 to 75°C (with no icing or condensation) | |
| | Ambient humidity | Operating: 10 to 90% Storage: 10 to 90% | |
| | Mounting method | DIN track mounting, surface mounting | |
| | Dielectric strength | 2.0 kVAC for 1 min. (between all inputs and exposed non-current-carrying metal parts; detection current: 10 mA max.) 3.0 kVAC for 1 min. (between all inputs and all outputs; detection current: 20 mA max.) 1.0 kVAC for 1 min. (between all outputs and non-current-carrying metal parts; detection current: 10 mA max.) | |
| | Insulation resistance | 100 MΩ min. (between all outputs and all inputs/exposed non-current-carrying metal parts) at 500 VDC | |
| | Vibration resistance | 10 to 55 Hz, 0.375-mm single amplitude for 2 h each in X, Y, and Z direction | |
| | Shock resistance | 300 m/s ² , 3 times each in ±X, ±Y, ±Z directions | |
| | Output indicator | Yes (color: green) | |
| | EMI | Conducted emissions | Conforms to EN61000-6-3 (Class B) |
| | | Radiated emissions | Conforms to EN61000-6-3 (Class B) |
| | Approved standards | UL: UL508 (listing, Class 2: Per UL1310), UL60950-1, UL1604 (Class I/Division 2) cUL: CSA C22.2 No. 14 (listing, Class2: Per CSA C22.2 No. 223), CSA C22.2 No. 213 (Class I/Division 2) cUR: CSA C22.2 No.60950-1 EN/VDE: EN60950-1 (=VDE 0805 Teil 1), EN50178 (=VDE 0160) | |
| | Weight | 240 g max. | |

Note: 1. This product has been approved for safety standards only when an AC input is used. It has not been approved when a DC input is used.

2. Refer to the Engineering Data section on page 4 for details.

3. If the V. ADJ adjuster is turned, the voltage will increase by more than 15% of the voltage adjustment range.

Check the output voltage of the power supply when converting the output voltage, and make sure that the load will not be damaged.

Connections

Block Diagram

ZEN-PA03024

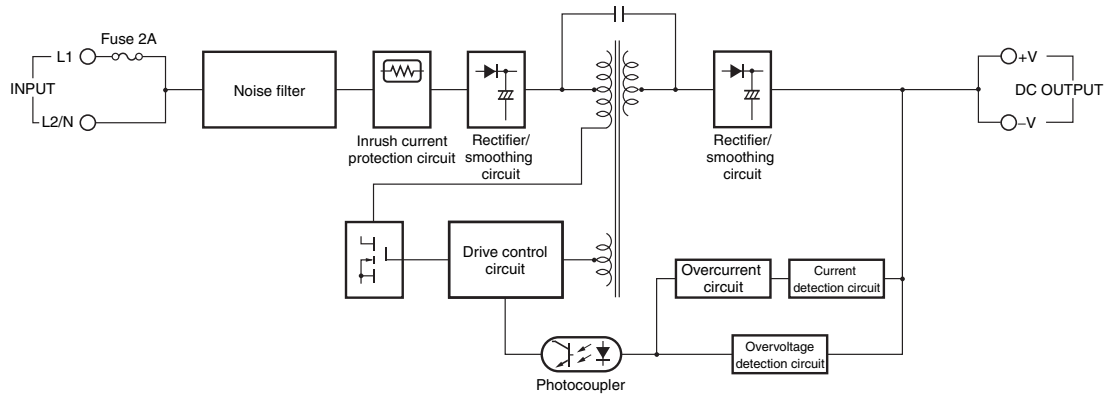

Note: The Power Supply is provided with reinforced insulation between the input and output terminals.

Installation

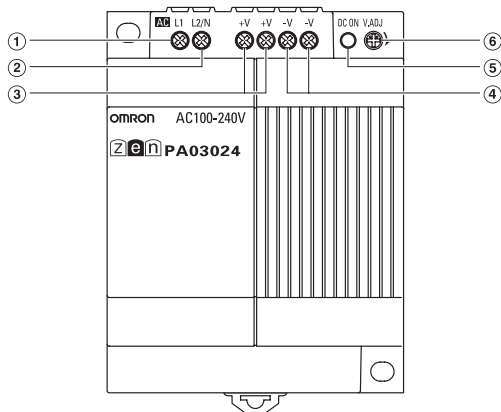

| No. | Name | Function |
|-----|---------------------------------|---|
| 1 | AC input terminal (L1) | Connect the input line to this terminal. A fuse is included in the circuit. |
| 2 | AC input terminal (L2/N) | Connect the input line to this terminal. Negative pole for DC input. |
| 3 | DC output terminals (+V) | Connect the load lines to these terminals. |
| 4 | DC output terminals (-V) | Connect the load lines to these terminals. |
| 5 | Output indicator (DC ON: Green) | Lights while a direct current (DC) output is ON. |
| 6 | Output voltage adjuster (V.ADJ) | Use to adjust the voltage. |

Engineering Data

Derating Curve

85 to 264 VAC or 110 to 350 VDC input

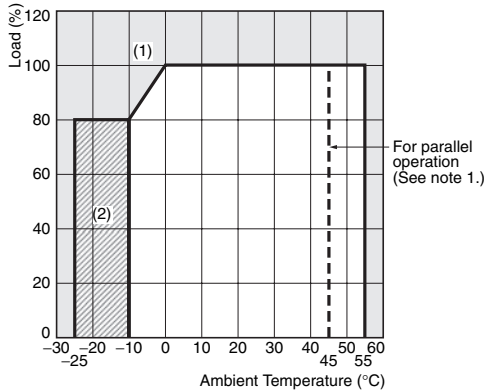

95 to 110 VDC input

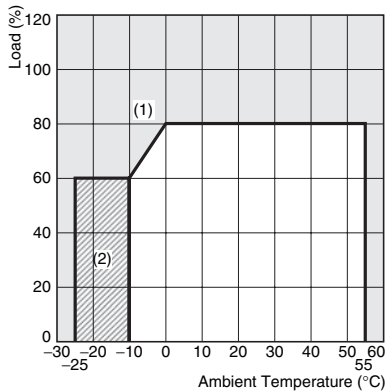

- Note:**
1. The maximum ambient temperature for parallel operation is 45°C.
 2. Parallel operation is not possible for an input of 95 to 110 VDC.
 3. Although operation is possible in the (2) portion of the derating curve, performance may be adversely affected, i.e., ripple noise may increase.
 4. Internal parts may occasionally deteriorate or be damaged. Do not use the Power Supply in areas outside the derating curve (i.e., the area shown by shading (1) in the above graph).

Installation

Correct

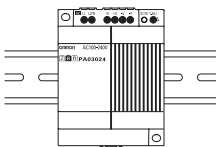

Standard mounting

Incorrect



Face-up mounting

- Note:**
1. Improper mounting will interfere with heat dissipation and may occasionally result in deterioration or damage of internal parts. Use the standard mounting.
 2. If there is a derating problem, use forced air-cooling. The ambient temperature is specified for a point 50 mm below the Power Supply.

Overload Protection

The Power Supply is provided with an overload protection function that protects the load and the power supply from possible damage by overcurrent. When the output current rises above 105% min. of the rated current, the protection function is triggered, decreasing the output voltage. When the output current falls within the rated range, the overload protection function is automatically cleared.

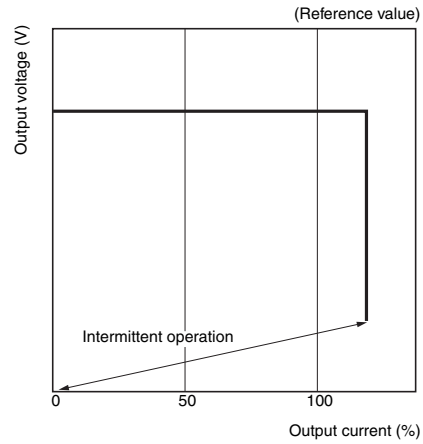

The values shown in the above diagrams are for reference only.

- Note:**
1. Internal parts may occasionally deteriorate or be damaged if a short-circuited or overcurrent state continues during operation.
 2. Internal parts may possibly deteriorate or be damaged if the Power Supply is used for applications with frequent inrush current or overloading at the load end. Do not use the Power Supply for such applications.

Inrush Current, Start Up Time, Hold Time

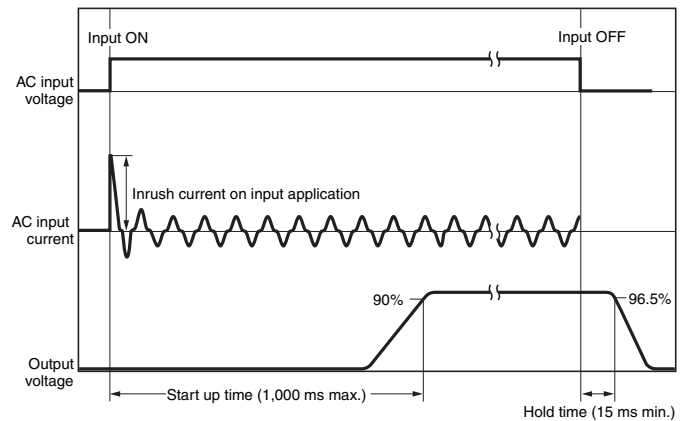

Dimensions

Note: All units are in millimeters unless otherwise indicated.

ZEN-PA03024

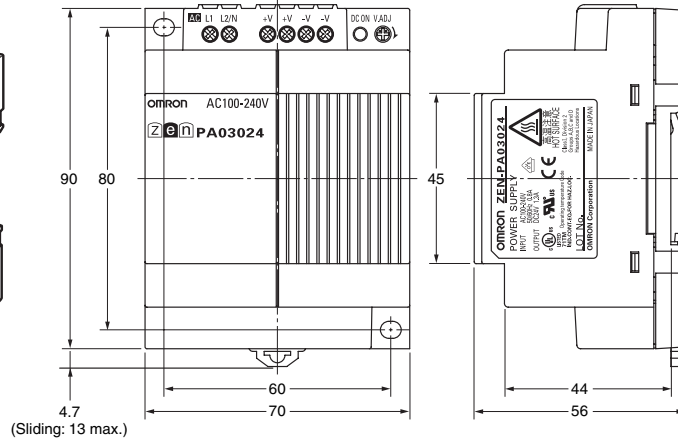
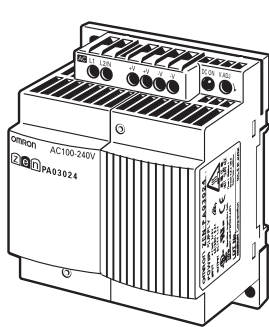

Surface Mounting Holes

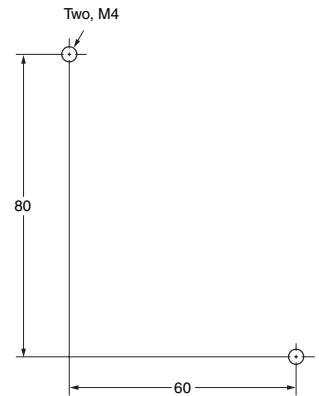

Accessories (Order Separately)

Mounting Track PFP-100N, PFP-50N

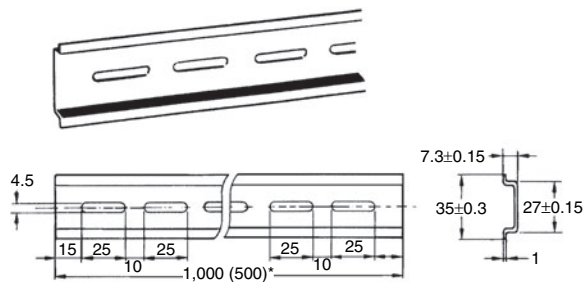

PFP-100N2

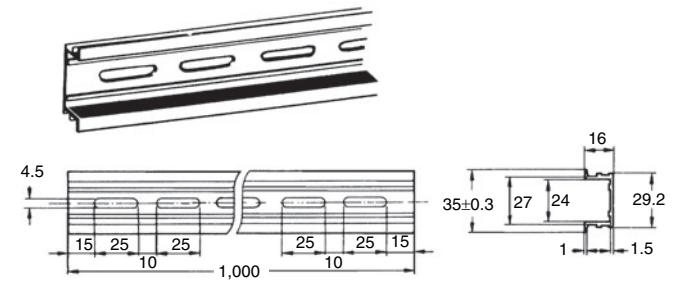

* The value shown in parentheses is for the PFP-50N.

End Plate PFP-M

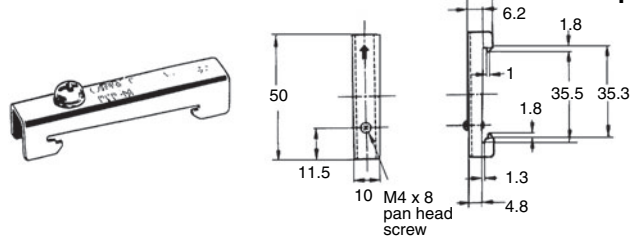

Spacer PFP-S

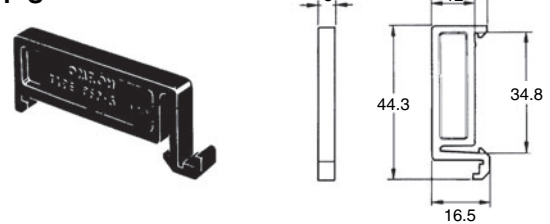

Safety Precautions

Refer to *Safety Precautions for All Timers*.

CAUTION

Minor electric shock may occasionally occur. Do not disassemble the product or touch internal parts.

Minor fires may occasionally occur. Do not attempt to repair or modify the product.

Minor burns may occasionally occur. Do not touch the product while power is being supplied or immediately after power is turned OFF.

Minor fires may occasionally occur. Tighten terminal screws to a torque of 0.5 to 0.6 N·m so that they do not become loose.

Minor electric shock may occasionally occur during operation. Do not touch the input and output terminals while power is being supplied.

The product may occasionally be damaged. Do not allow any clippings or cuttings to enter the product during installation work.

Working voltage can be 350 V max. inside. This voltage can be also available 10 s after the switch off.

Precautions for Safe Use

The following precautions must be observed to ensure safety.

Mounting

- Mounting Direction
(Refer to *Installation* in *Engineering Data* on page 4.)

| | |
|---------------------|---------|
| Standard Mounting | Valid |
| Horizontal Mounting | Invalid |
| Other Mounting | Invalid |

The internal parts may occasionally deteriorate or be broken due to adverse heat dissipation depending on the mounting status. Do not use the product in any way other than the standard mounting direction.

- Mounting Space

Make sure that sufficient heat dissipation is provided when installing the Power Supply to increase its long-term reliability. Install the product in a location that allows a natural airflow to occur around the Power Supply.

We recommend using End Plates (PFP-M) to secure the Power Supply and to ensure that a space of at least 10 mm is maintained between Power Supplies.

If the installation space above and below the Power Supply is less than 50 mm, reduce the ambient temperature by 5°C. A minimum space of 20 mm is required.

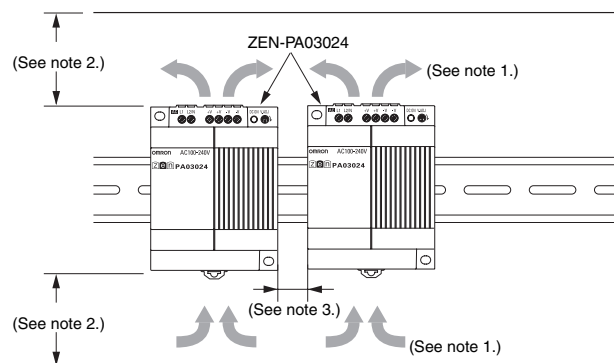

- Note:**
1. Convection of air
 2. 50 mm min.
 3. 10 mm min.

Wiring

- Minor fire may possibly occur. Ensure that input and output terminals are wired correctly.
- Use the following material for the wires to be connected to the Power Supply to prevent smoking or ignition caused by abnormal loads.

Use solid wires. Always attach pin crimp terminals when using stranded wire. The stripping distance should be 6.5 mm.

Recommended Wire Type

| | |
|---------------------|--|
| Solid wire | Cross section 0.5 to 2.5 mm ² (Equivalent to AWG20 to AWG14) |
| Stranded wire | Cross section 0.5 to 2.5 mm ² (Equivalent to AWG20 to AWG14) |
| Pin crimp terminals | Dia.: 1.1 to 2.3 mm |

- Do not apply more than 100 N force to the terminal block when tightening the terminals.
- Be sure to remove the sheet covering the product before turning ON the Power Supply and confirm that nothing is interfering with heat dissipation.

Installation Environment

- Do not use the Power Supply in locations subject to shocks or vibrations. In particular, install the Power Supply as far away as possible from contactors or other devices that are a vibration source.
- Install the Power Supply well away from any sources of strong, high-frequency noise.

Operating and Storage Conditions

- When installing the Power Supply, check for any signs that the product or packaging has been struck. If internal parts have been damaged, overvoltages may be output depending on the location of the damage.
- Internal parts may occasionally deteriorate or be damaged. Store the Power Supply at a temperature of -25 to 65°C and a humidity of 10% to 90%.
- Internal parts may occasionally deteriorate or be damaged. Do not use the Power Supply in areas outside the derating curve (i.e., the area shown by shading (1) in the graph on page 4). For UL508 Listing, the surrounding air temperature should be 40°C.
- Use the Power Supply at a humidity of 10% to 90%.
- Do not use the Power Supply in locations where condensation may occur due to high humidity or where temperature changes are severe.
- Do not use the Power Supply in locations subject to direct sunlight.
- Do not use the Power Supply in locations where liquids, foreign matter, or corrosive gases may enter the interior of products.

Overload Protection

- Internal parts may possibly deteriorate or be damaged if a short-circuited or overcurrent state continues during operation.
- Internal parts may possibly deteriorate or be damaged if the Power Supply is used for applications with frequent inrush current or overloading at the load end. Do not use the Power Supply for such applications.

Charging the Battery

- This product is not intended to function as a battery charger. If a battery is to be connected as the load, mount an overcurrent limiting circuit and an overvoltage protection circuit.

Output Voltage Adjuster

- The output voltage adjuster (V.ADJ) may possibly be damaged if it is turned with unnecessary force. Do not turn the adjuster with excessive force.
- After changing the setting of the adjuster, make sure that the output capacity and output current do not exceed the rated output capacity and rated output current.
- Output voltage is adjustable with the output voltage adjuster (V.ADJ) on the front surface of the product from -10% to $+15\%$ of the rated output voltage.
Do not increase the output voltage by more than 10% when connected to a ZEN CPU Unit rated for 24 VDC.

DIN Track Mounting

To mount the Power Supply on a DIN track, hook portion (A) of the Power Supply onto the track and press the Power Supply in direction (B).

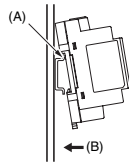

To dismount the Power Supply, pull down portion (C) with a flat-blade screwdriver and pull out the Power Supply.

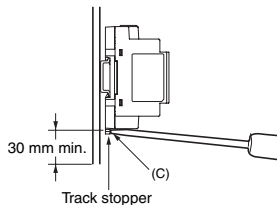

Series Operation

The Power Supply is not designed for series operation.

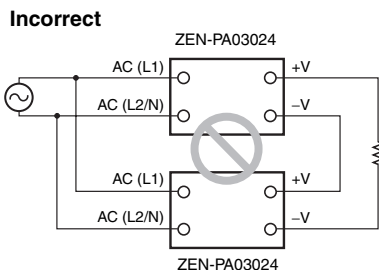

Output voltage (\pm)

Two Power Supplies can be used to create a \pm output.

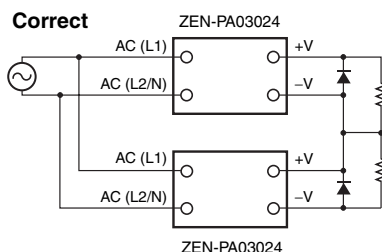

Note: When the load is an operational amplifier or other device allowing series operation, a startup failure may occur when the Power Supply is turned ON and internal circuits may be damaged. Connect a diode as shown in the figure to prevent this.

Use the following guidelines to select the diode.

| Type | Schottky Barrier diode |
|-----------------------------------|---|
| Dielectric strength (V_{RRM}) | Twice the rated output voltage or above |
| Forward current (I_F) | Twice the rated output voltage or above |

Parallel Operation

Two Power Supplies can be operated in parallel.

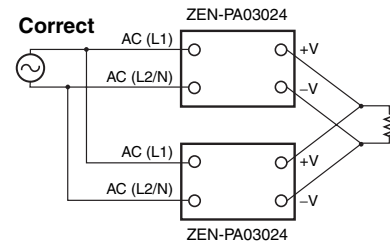

- Note:**
- For parallel operation, a maximum of two Power Supplies of the same model can be connected.
 - For a DC input, parallel operation is possible only for 110 to 350 VDC.
 - To ensure that the voltage drop between each Power Supply and the load is the same, use the same wire length and thickness to connect the load.
 - The load current will become imbalanced if the output voltages are different, possibly causing a serious reduction in the life of one of the Power Supplies. Adjust the output voltages of the Power Supplies to the same value.

In Case there is No Output Voltage

The possible cause for no output voltage may be the presence of an overload or overvoltage condition, or may be due to the functioning of a latching protective device. The latching protection may operate if a large amount of surge voltage such as a lightning surge occurs while turning ON the Power Supply.

In case there is no output voltage, please check the following points before contacting us:

- Check the overload protected status:
Check whether the load is in overload status or is short-circuited. Remove wires to load when checking.
- Attempt to clear the latching protection function:
Turn the power supply OFF once, and leave it OFF for at least 1 minute. Then turn it on again to see if this clears the condition.

Insulation Resistance Test

When performing the test, be sure to short-circuit all the output terminals to protect them from damage.

Dielectric Strength Test

- When a high voltage is applied between the input terminals and the output terminals, electric energy builds up across the inductor L and capacitor C of the internal noise filter. This energy may generate a voltage surge when a high voltage is applied to the Power Supply by a switch or timer, and as a result, the internal parts of the Power Supply may possibly be damaged. To prevent voltage impulses when testing, decrease the applied voltage using the variable resistor on the dielectric strength testing equipment, or apply the voltage so that it crosses the zero point when it rises or falls.
- When performing the test, be sure to short-circuit all the output terminals to protect them from damage.

ALL DIMENSIONS SHOWN ARE IN MILLIMETERS.

To convert millimeters into inches, multiply by 0.03937. To convert grams into ounces, multiply by 0.03527.

In the interest of product improvement, specifications are subject to change without notice.

Read and Understand This Catalog

Please read and understand this catalog before purchasing the products. Please consult your OMRON representative if you have any questions or comments.

Warranty and Limitations of Liability

WARRANTY

OMRON's exclusive warranty is that the products are free from defects in materials and workmanship for a period of one year (or other period if specified) from date of sale by OMRON.

OMRON MAKES NO WARRANTY OR REPRESENTATION, EXPRESS OR IMPLIED, REGARDING NON-INFRINGEMENT, MERCHANTABILITY, OR FITNESS FOR PARTICULAR PURPOSE OF THE PRODUCTS. ANY BUYER OR USER ACKNOWLEDGES THAT THE BUYER OR USER ALONE HAS DETERMINED THAT THE PRODUCTS WILL SUITABLY MEET THE REQUIREMENTS OF THEIR INTENDED USE. OMRON DISCLAIMS ALL OTHER WARRANTIES, EXPRESS OR IMPLIED.

LIMITATIONS OF LIABILITY

OMRON SHALL NOT BE RESPONSIBLE FOR SPECIAL, INDIRECT, OR CONSEQUENTIAL DAMAGES, LOSS OF PROFITS OR COMMERCIAL LOSS IN ANY WAY CONNECTED WITH THE PRODUCTS, WHETHER SUCH CLAIM IS BASED ON CONTRACT, WARRANTY, NEGLIGENCE, OR STRICT LIABILITY.

In no event shall the responsibility of OMRON for any act exceed the individual price of the product on which liability is asserted.

IN NO EVENT SHALL OMRON BE RESPONSIBLE FOR WARRANTY, REPAIR, OR OTHER CLAIMS REGARDING THE PRODUCTS UNLESS OMRON'S ANALYSIS CONFIRMS THAT THE PRODUCTS WERE PROPERLY HANDLED, STORED, INSTALLED, AND MAINTAINED AND NOT SUBJECT TO CONTAMINATION, ABUSE, MISUSE, OR INAPPROPRIATE MODIFICATION OR REPAIR.

Application Considerations

SUITABILITY FOR USE

OMRON shall not be responsible for conformity with any standards, codes, or regulations that apply to the combination of products in the customer's application or use of the products.

At the customer's request, OMRON will provide applicable third party certification documents identifying ratings and limitations of use that apply to the products. This information by itself is not sufficient for a complete determination of the suitability of the products in combination with the end product, machine, system, or other application or use.

The following are some examples of applications for which particular attention must be given. This is not intended to be an exhaustive list of all possible uses of the products, nor is it intended to imply that the uses listed may be suitable for the products:

- Outdoor use, uses involving potential chemical contamination or electrical interference, or conditions or uses not described in this catalog.
- Nuclear energy control systems, combustion systems, railroad systems, aviation systems, medical equipment, amusement machines, vehicles, safety equipment, and installations subject to separate industry or government regulations.
- Systems, machines, and equipment that could present a risk to life or property.

Please know and observe all prohibitions of use applicable to the products.

NEVER USE THE PRODUCTS FOR AN APPLICATION INVOLVING SERIOUS RISK TO LIFE OR PROPERTY WITHOUT ENSURING THAT THE SYSTEM AS A WHOLE HAS BEEN DESIGNED TO ADDRESS THE RISKS, AND THAT THE OMRON PRODUCTS ARE PROPERLY RATED AND INSTALLED FOR THE INTENDED USE WITHIN THE OVERALL EQUIPMENT OR SYSTEM.

PROGRAMMABLE PRODUCTS

OMRON shall not be responsible for the user's programming of a programmable product, or any consequence thereof.

Disclaimers

CHANGE IN SPECIFICATIONS

Product specifications and accessories may be changed at any time based on improvements and other reasons.

It is our practice to change model numbers when published ratings or features are changed, or when significant construction changes are made. However, some specifications of the products may be changed without any notice. When in doubt, special model numbers may be assigned to fix or establish key specifications for your application on your request. Please consult with your OMRON representative at any time to confirm actual specifications of purchased products.

DIMENSIONS AND WEIGHTS

Dimensions and weights are nominal and are not to be used for manufacturing purposes, even when tolerances are shown.

PERFORMANCE DATA

Performance data given in this catalog is provided as a guide for the user in determining suitability and does not constitute a warranty. It may represent the result of OMRON's test conditions, and the users must correlate it to actual application requirements. Actual performance is subject to the OMRON Warranty and Limitations of Liability.

ERRORS AND OMISSIONS

The information in this document has been carefully checked and is believed to be accurate; however, no responsibility is assumed for clerical, typographical, or proofreading errors, or omissions.

2010.10

In the interest of product improvement, specifications are subject to change without notice.

OMRON Corporation
Industrial Automation Company

<http://www.ia.omron.com/>

(c)Copyright OMRON Corporation 2010 All Right Reserved.

Данный компонент на территории Российской Федерации

Вы можете приобрести в компании MosChip.

Для оперативного оформления запроса Вам необходимо перейти по данной ссылке:

<http://moschip.ru/get-element>

Вы можете разместить у нас заказ для любого Вашего проекта, будь то серийное производство или разработка единичного прибора.

В нашем ассортименте представлены ведущие мировые производители активных и пассивных электронных компонентов.

Нашей специализацией является поставка электронной компонентной базы двойного назначения, продукции таких производителей как XILINX, Intel (ex.ALTERA), Vicor, Microchip, Texas Instruments, Analog Devices, Mini-Circuits, Amphenol, Glenair.

Сотрудничество с глобальными дистрибьюторами электронных компонентов, предоставляет возможность заказывать и получать с международных складов практически любой перечень компонентов в оптимальные для Вас сроки.

На всех этапах разработки и производства наши партнеры могут получить квалифицированную поддержку опытных инженеров.

Система менеджмента качества компании отвечает требованиям в соответствии с ГОСТ Р ИСО 9001, ГОСТ РВ 0015-002 и ЭС РД 009

Офис по работе с юридическими лицами:

105318, г.Москва, ул.Щербаковская д.3, офис 1107, 1118, ДЦ «Щербаковский»

Телефон: +7 495 668-12-70 (многоканальный)

Факс: +7 495 668-12-70 (доб.304)

E-mail: info@moschip.ru

Skype отдела продаж:

moschip.ru

moschip.ru_4

moschip.ru_6

moschip.ru_9