

Description

The 74HCT32 provides provides four independent 2-input OR gates with standard push-pull outputs. The device is designed for operation with a power supply range of 4.5V to 5.5V.

The gates perform the Boolean function:

$$Y = A + B \text{ or } Y = \overline{\overline{A} \bullet \overline{B}}$$

Features

- Wide Supply Voltage Range from 4.5V to 5.5V
- Pin Compatible with Low Power Schottky (LSTTL)
- Inputs Are TTL Voltage Level Compatible
- Sinks or Sources 4mA at $V_{CC} = 4.5V$
- CMOS Low Power Consumption
- Schmitt Trigger Action at All Inputs
- ESD Protection Exceeds JESD 22
 - 200-V Machine Model (A115-A)
 - 2000-V Human Body Model (A114-A)
 - Exceeds 1000-V Charged Device Model (C101C)
- Range of Package Options SO-14 and TSSOP-14
- **Totally Lead-Free & Fully RoHS Compliant (Notes 1 & 2)**
- **Halogen and Antimony Free. "Green" Device (Note 3)**

- Notes:
1. No purposely added lead. Fully EU Directive 2002/95/EC (RoHS) & 2011/65/EU (RoHS 2) compliant.
 2. See <http://www.diodes.com> for more information about Diodes Incorporated's definitions of Halogen- and Antimony-free, "Green" and Lead-free.
 3. Halogen- and Antimony-free "Green" products are defined as those which contain <900ppm bromine, <900ppm chlorine (<1500ppm total Br + Cl) and <1000ppm antimony compounds.

Pin Assignments

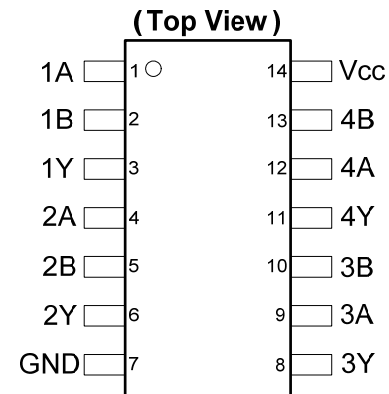

SO-14 / TSSOP-14

Applications

- General Purpose Logic
- Wide array of products such as:
 - PCs, networking, notebooks, netbooks
 - Computer peripherals, hard drives, CD/DVD ROM
 - TV, DVD, DVR, set top box

Pin Descriptions

Pin Number	Pin Name	Function
1	1A	Data Input
2	1B	Data Input
3	1Y	Data Output
4	2A	Data Input
5	2B	Data Input
6	2Y	Data Output
7	GND	Ground
8	3Y	Data Output
9	3A	Data Input
10	3B	Data Input
11	4Y	Data Output
12	4A	Data Input
13	4B	Data Input
14	V _{CC}	Supply Voltage

Logic Diagram

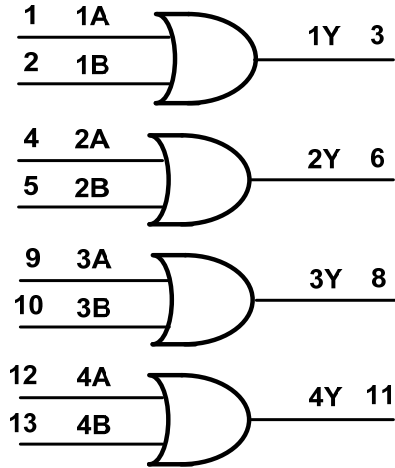

Function Table

Inputs		Output
A	B	Y
L	L	L
L	H	H
H	L	H
H	H	H

Absolute Maximum Ratings (Note 4) (@ $T_A = +25^\circ\text{C}$, unless otherwise specified.)

Symbol	Description	Rating	Unit
ESD HBM	Human Body Model ESD Protection	2	KV
ESD CDM	Charged Device Model ESD Protection	1	KV
ESD MM	Machine Model ESD Protection	200	V
V_{CC}	Supply Voltage Range	-0.5 to +7.0	V
V_I	Input Voltage Range (Note 5)	-0.5 to +7.0	V
I_{IK}	Input Clamp Current $V_I < -0.5\text{V}$ or $V_I > V_{CC} + 0.5\text{V}$	± 20	mA
I_{OK}	Output Clamp Current $V_O < -0.5\text{V}$ or $V_O > V_{CC} + 0.5\text{V}$	± 20	mA
I_O	Continuous Output Current $-0.5\text{V} < V_O < V_{CC} + 0.5\text{V}$	+/- 25	mA
I_{CC}	Continuous Current Through V_{CC}	50	mA
I_{GND}	Continuous Current Through GND	-50	mA
T_J	Operating Junction Temperature	-40 to +150	$^\circ\text{C}$
T_{STG}	Storage Temperature	-65 to +150	$^\circ\text{C}$
P_{TOT}	Total Power Dissipation	500	mW

- Notes: 4. Stresses beyond the absolute maximum may result in immediate failure or reduced reliability. These are stress values and device operation should be within recommend values.
5. Input Voltage cannot exceed V_{CC} to the extent the Maximum clamp current is exceeded.

Recommended Operating Conditions (Note 6) (@ $T_A = +25^\circ\text{C}$, unless otherwise specified.)

Symbol	Parameter	Conditions	Min	Max	Unit
V_{CC}	Supply Voltage		4.5	5.5	V
V_I	Input Voltage		0	V_{CC}	V
V_O	Output Voltage		0	V_{CC}	V
$\Delta t/\Delta V$	Input Transition Rise or Fall Rate	$V_{CC} = 4.5\text{V}$ to 5.5V		500	ns/V
T_A	Operating Free-Air Temperature		-40	+125	$^\circ\text{C}$

Note: 6. Unused inputs should be held at V_{CC} or Ground.

Electrical Characteristics (@ $T_A = +25^\circ\text{C}$, unless otherwise specified.)

Symbol	Parameter	Test Conditions	V_{CC}	$T_A = -40^\circ\text{C}$ to $+85^\circ\text{C}$		$T_A = -40^\circ\text{C}$ to $+125^\circ\text{C}$		Unit
				Min	Max	Min	Max	
V_{IH}	High-level Input Voltage		4.5V to 5.5V	2.0		2.0		V
V_{IL}	Low-level Input Voltage		4.5V to 5.5V		0.8		0.8	V
V_{OH}	High-level Output Voltage	$I_{OH} = -20\mu\text{A}$	4.5V	4.4		4.4		V
		$I_{OH} = -4\text{mA}$	4.5V	3.80		3.70		
V_{OL}	Low-level Output Voltage	$I_{OL} = 20\mu\text{A}$	4.5V		0.1		0.1	V
		$I_{OL} = 4\text{mA}$	4.5V		0.33		0.4	
I_I	Input Current	$V_I = \text{GND}$ to 6.0V	6.0V		± 1		± 1	μA
I_{CC}	Supply Current	$V_I = \text{GND}$ or V_{CC} , $I_O = 0$	6.0V		20		40	μA
ΔI_{CC}	Additional Supply Current	One input at $V_{CC} - 2.1\text{V}$ Other pins at V_{CC} or GND	4.5V to 5.5V		675		735	μA

Switching Characteristics

Symbol	Parameter	Test Conditions	V _{CC}	T _A = +25°C			-40°C to +85°C	-40°C to +125°C	Unit
				Min	Typ	Max	Max	Max	
t _{PD}	Propagation Delay A _N to Y _N	Figure 1 C _L = 50pF	4.5V	—	11	24	30	36	ns
t _t	Transition Time	Figure 1 C _L = 50pF	4.5V	—	7	15	19	22	ns

Operating Characteristics (@T_A = +25°C, unless otherwise specified.)

Parameter		Test Conditions	V _{CC} = 5.5 V	Unit
			Typ	
C _{pd}	Power Dissipation Capacitance per Gate	f = 1 MHz	28	pF
C _i	Input Capacitance	V _i = V _{CC} – or GND	4	pF

Parameter Measurement Information

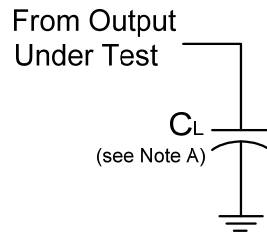

V _{CC}	Inputs		V _M	C _L
	V _i	t _r /t _f		
4.5V	3.0V	3ns	1.5V	V _{OH} /2

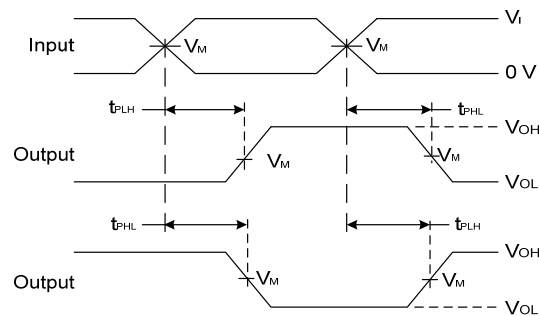
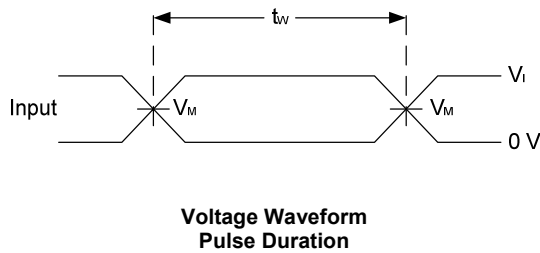

- Notes:
- A. Includes test lead and test apparatus capacitance.
 - B. All pulses are supplied at pulse repetition rate ≤ 1 MHz.
 - C. Inputs are measured separately one transition per measurement.
 - D. t_{PLH} and t_{PHL} are the same as t_{PD}.

Figure 1 Load Circuit and Voltage Waveforms

Ordering Information

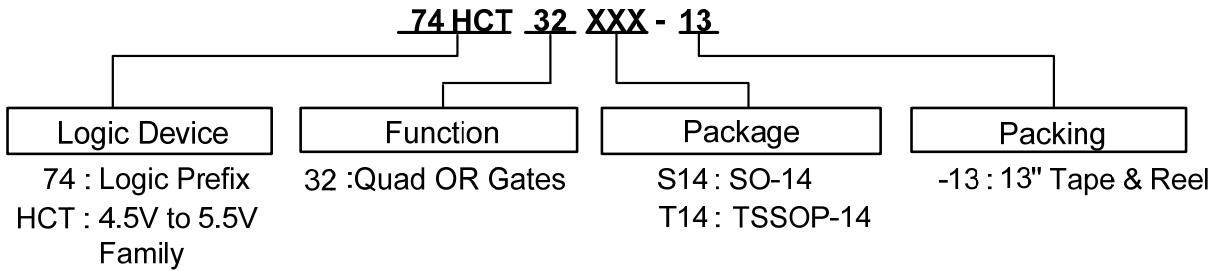

Part Number	Package Code	Packaging	7" Tape and Reel	
			Quantity	Part Number Suffix
74HCT32S14-13	S14	SO-14	2500/Tape & Reel	-13
74HCT32T14-13	T14	TSSOP-14	2500/Tape & Reel	-13

Marking Information

(1) SO-14, TSSOP-14

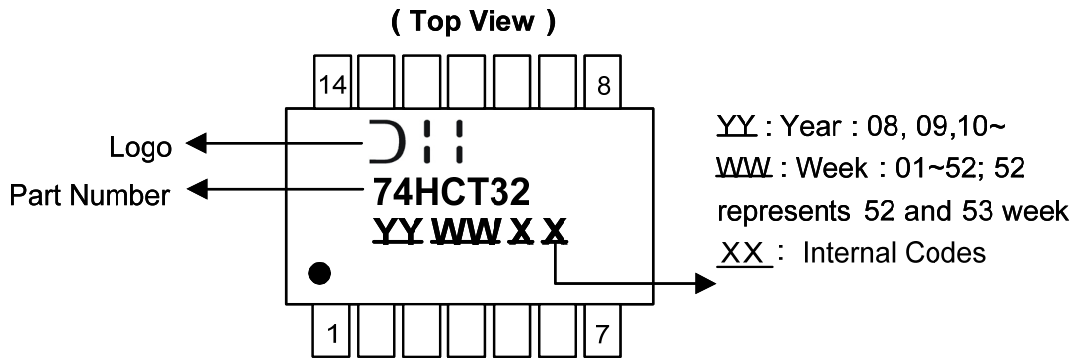

Part Number	Package
74HCT32S14	SO-14
74HCT32T14	TSSOP-14

Package Outline Dimensions (All dimensions in mm.)

Please see AP02002 at <http://www.diodes.com/datasheets/ap02002.pdf> for latest version.

Package Type: SO-14

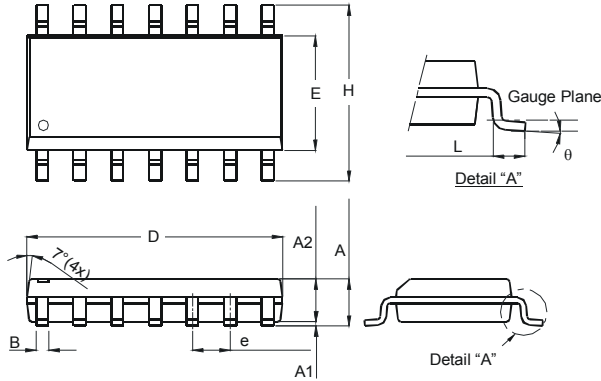

SO-14		
Dim	Min	Max
A	1.47	1.73
A1	0.10	0.25
A2	1.45 Typ	
B	0.33	0.51
D	8.53	8.74
E	3.80	3.99
e	1.27 Typ	
H	5.80	6.20
L	0.38	1.27
θ	0°	8°
All Dimensions in mm		

Package Type: TSSOP-14

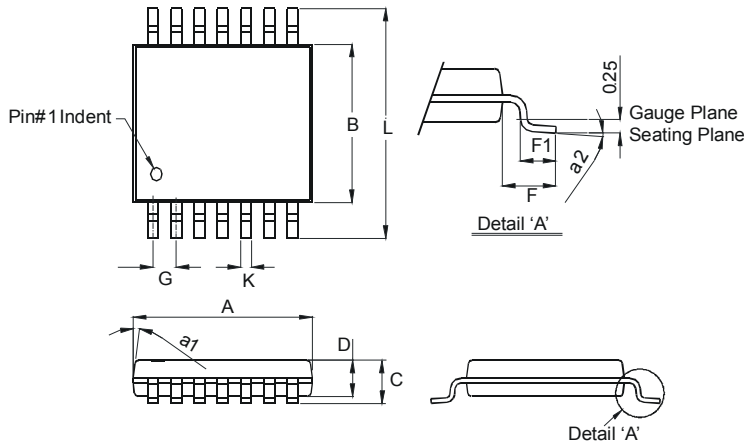

TSSOP-14		
Dim	Min	Max
a1	7° (4X)	
a2	0°	8°
A	4.9	5.10
B	4.30	4.50
C	— 1.2	
D	0.8	1.05
F	1.00 Typ	
F1	0.45	0.75
G	0.65 Typ	
K	0.19	0.30
L	6.40 Typ	
All Dimensions in mm		

Suggested Pad Layout

Please see AP02001 at <http://www.diodes.com/datasheets/ap02001.pdf> for latest version.

Package Type: SO-14

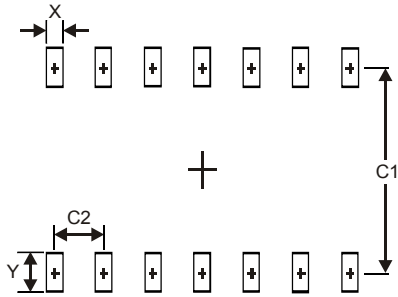

Dimensions	Value (in mm)
X	0.60
Y	1.50
C1	5.4
C2	1.27

Package Type: TSSOP-14

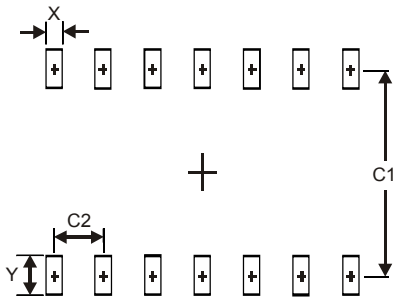

Dimensions	Value (in mm)
X	0.45
Y	1.45
C1	5.9
C2	0.65

IMPORTANT NOTICE

DIODES INCORPORATED MAKES NO WARRANTY OF ANY KIND, EXPRESS OR IMPLIED, WITH REGARDS TO THIS DOCUMENT, INCLUDING, BUT NOT LIMITED TO, THE IMPLIED WARRANTIES OF MERCHANTABILITY AND FITNESS FOR A PARTICULAR PURPOSE (AND THEIR EQUIVALENTS UNDER THE LAWS OF ANY JURISDICTION).

Diodes Incorporated and its subsidiaries reserve the right to make modifications, enhancements, improvements, corrections or other changes without further notice to this document and any product described herein. Diodes Incorporated does not assume any liability arising out of the application or use of this document or any product described herein; neither does Diodes Incorporated convey any license under its patent or trademark rights, nor the rights of others. Any Customer or user of this document or products described herein in such applications shall assume all risks of such use and will agree to hold Diodes Incorporated and all the companies whose products are represented on Diodes Incorporated website, harmless against all damages.

Diodes Incorporated does not warrant or accept any liability whatsoever in respect of any products purchased through unauthorized sales channel. Should Customers purchase or use Diodes Incorporated products for any unintended or unauthorized application, Customers shall indemnify and hold Diodes Incorporated and its representatives harmless against all claims, damages, expenses, and attorney fees arising out of, directly or indirectly, any claim of personal injury or death associated with such unintended or unauthorized application.

Products described herein may be covered by one or more United States, international or foreign patents pending. Product names and markings noted herein may also be covered by one or more United States, international or foreign trademarks.

This document is written in English but may be translated into multiple languages for reference. Only the English version of this document is the final and determinative format released by Diodes Incorporated.

LIFE SUPPORT

Diodes Incorporated products are specifically not authorized for use as critical components in life support devices or systems without the express written approval of the Chief Executive Officer of Diodes Incorporated. As used herein:

A. Life support devices or systems are devices or systems which:

1. are intended to implant into the body, or
2. support or sustain life and whose failure to perform when properly used in accordance with instructions for use provided in the labeling can be reasonably expected to result in significant injury to the user.

B. A critical component is any component in a life support device or system whose failure to perform can be reasonably expected to cause the failure of the life support device or to affect its safety or effectiveness.

Customers represent that they have all necessary expertise in the safety and regulatory ramifications of their life support devices or systems, and acknowledge and agree that they are solely responsible for all legal, regulatory and safety-related requirements concerning their products and any use of Diodes Incorporated products in such safety-critical, life support devices or systems, notwithstanding any devices- or systems-related information or support that may be provided by Diodes Incorporated. Further, Customers must fully indemnify Diodes Incorporated and its representatives against any damages arising out of the use of Diodes Incorporated products in such safety-critical, life support devices or systems.

Copyright © 2013, Diodes Incorporated

www.diodes.com

Данный компонент на территории Российской Федерации

Вы можете приобрести в компании MosChip.

Для оперативного оформления запроса Вам необходимо перейти по данной ссылке:

<http://moschip.ru/get-element>

Вы можете разместить у нас заказ для любого Вашего проекта, будь то серийное производство или разработка единичного прибора.

В нашем ассортименте представлены ведущие мировые производители активных и пассивных электронных компонентов.

Нашей специализацией является поставка электронной компонентной базы двойного назначения, продукции таких производителей как XILINX, Intel (ex.ALTERA), Vicor, Microchip, Texas Instruments, Analog Devices, Mini-Circuits, Amphenol, Glenair.

Сотрудничество с глобальными дистрибьюторами электронных компонентов, предоставляет возможность заказывать и получать с международных складов практически любой перечень компонентов в оптимальные для Вас сроки.

На всех этапах разработки и производства наши партнеры могут получить квалифицированную поддержку опытных инженеров.

Система менеджмента качества компании отвечает требованиям в соответствии с ГОСТ Р ИСО 9001, ГОСТ РВ 0015-002 и ЭС РД 009

Офис по работе с юридическими лицами:

105318, г.Москва, ул.Щербаковская д.3, офис 1107, 1118, ДЦ «Щербаковский»

Телефон: +7 495 668-12-70 (многоканальный)

Факс: +7 495 668-12-70 (доб.304)

E-mail: info@moschip.ru

Skype отдела продаж:

moschip.ru

moschip.ru_4

moschip.ru_6

moschip.ru_9