

## 5 Amp Output Current IGBT Gate Drive Optocoupler with 100 kV/ $\mu$ s Noise Immunity

### Data Sheet

---

#### Description

The ACNW3430 contains an LED, which is optically coupled to an integrated circuit with a power output stage. This optocoupler is ideally suited for driving IGBTs and power MOSFETs used in motor control inverter applications. The 100 kV/ $\mu$ s noise immunity prevents erroneous drive in noisy industrial environments. The voltage and high peak output current supplied by this optocoupler make it ideally suited for driving IGBTs directly. The ACNW3430 has the highest insulation voltage of  $V_{IORM} = 1414 V_{peak}$  in the IEC/EN/DIN EN 60747-5-5.

**CAUTION** It is advised that normal static precautions be taken in handling and assembly of this component to prevent damage and/or degradation that may be induced by ESD.

#### Features

- 5.0 A maximum peak output current
- Rail-to-rail output voltage
- UVLO with  $V_E$  reference for negative power supply
- 150 ns maximum propagation delay
- 90 ns maximum propagation delay difference
- LED current input with hysteresis
- 100 kV/ $\mu$ s minimum Common Mode Rejection (CMR) at  $V_{CM} = 1500 V$
- $I_{CC} = 5.0 mA$  maximum supply current
- Under Voltage Lock-Out Protection (UVLO) with Hysteresis
- Wide Operating  $V_{CC}$  Range: 15 V to 30 V
- Industrial Temperature Range:  $-40^\circ C$  to  $105^\circ C$
- Safety Approval
  - UL Recognized 5000  $V_{RMS}$  for 1min.
  - CSA
  - IEC/EN/DIN EN 60747-5-5  $V_{IORM} = 1414 V_{peak}$

#### Applications

- IGBT/MOSFET gate drive
- AC and brushless DC motor drives
- Renewable energy inverters
- Industrial inverters
- Switching power supplies

## Functional Diagram

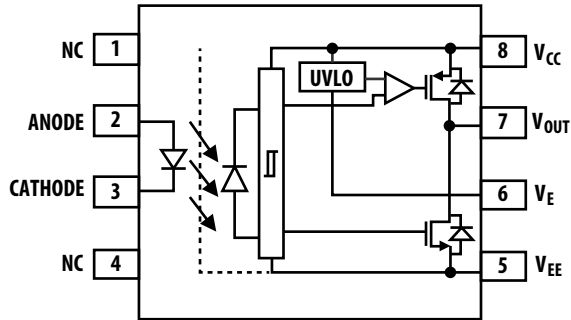

**Design Notes:** A 1- $\mu$ F bypass capacitor must be connected between pins  $V_{CC}$  and  $V_{EE}$ .

## Truth Table – ACNW3430

LED	$V_{CC} - V_{EE}$ "POSITIVE GOING" (i.e., TURN-ON)	$V_{CC} - V_{EE}$ "NEGATIVE GOING" (i.e., TURN-OFF)	VO
OFF	0 V to 30 V	0 V to 30 V	LOW
ON	0 V to 11.9 V	0 V to 10.9 V	LOW
ON	11.9 V - to 13.2 V	10.9 V to 12.2 V	TRANSITION
ON	13.2 V – to 30 V	12.2 V to 30V	HIGH

## Ordering Information

ACNW3430 is UL Recognized with 5000  $V_{RMS}$  for 1 minute per UL1577.

Part Number	Option	Package	Gull Wing Surface Mount	Tape and Reel	IEC/EN/DIN EN 60747-5-5	Quantity
	RoHS Compliant					
ACNW3430	-000E	400mil DIP-8			X	42 per tube
	-300E		X		X	42 per tube
	-500E		X	X	X	750 per reel

To order, choose a part number from the part number column and combine with the desired option from the option column to form an order entry.

Example 1:

ACNW3430-500E to order product of 400mil DIP Gull Wing Surface Mount package in Tape and Reel packaging with IEC/EN/DIN EN 60747-5-5 Safety Approval in RoHS compliant.

Example 2:

ACNW3430-000E to order product of 400mil DIP package in Tube packaging and RoHS compliant.

Option data sheets are available. Contact your Avago sales representative or authorized distributor for information.

## Package Outline Drawings

### ACNW3430 Outline Drawing (8-pin Wide Body Package / 400mil DIP)

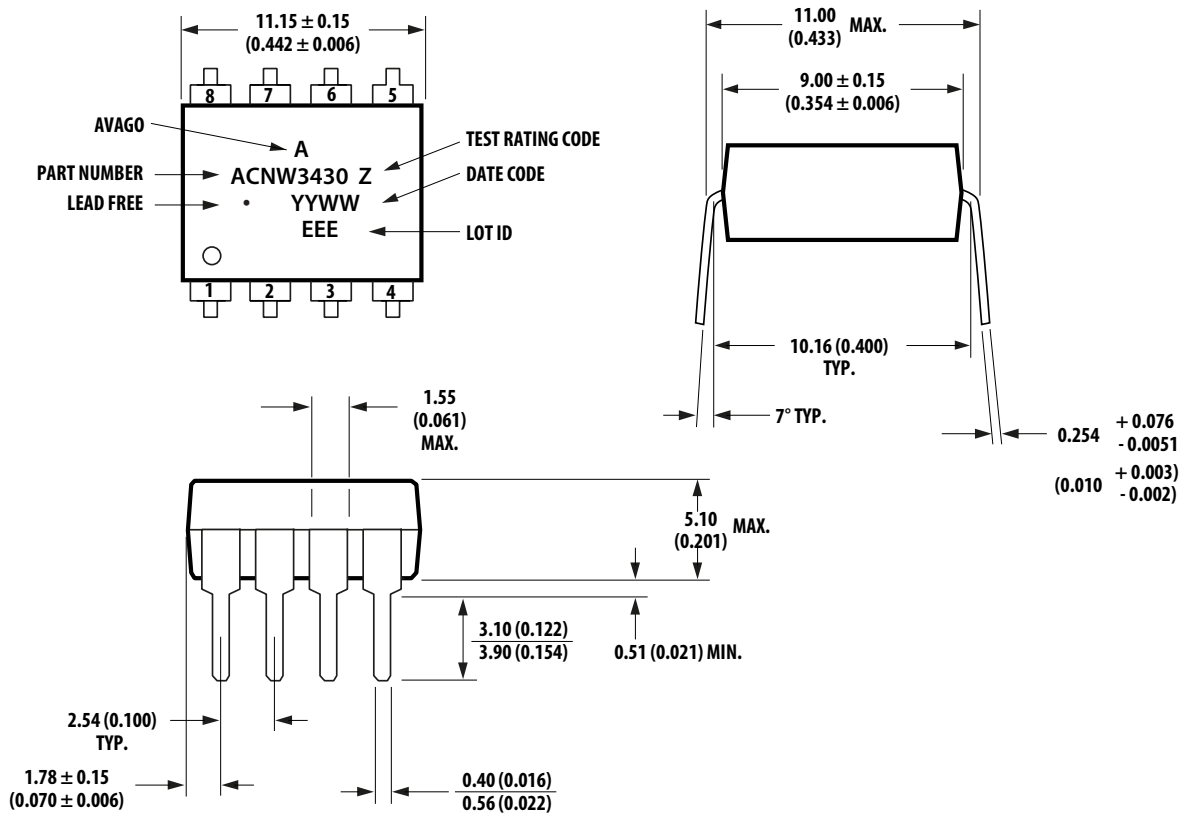

Dimensions in millimeters (inches).

**NOTE** Floating Lead Protrusion is 0.25 mm (10 mils) maximum.

## ACNW3430 Gull Wing Surface Mount Option 300 Outline Drawing

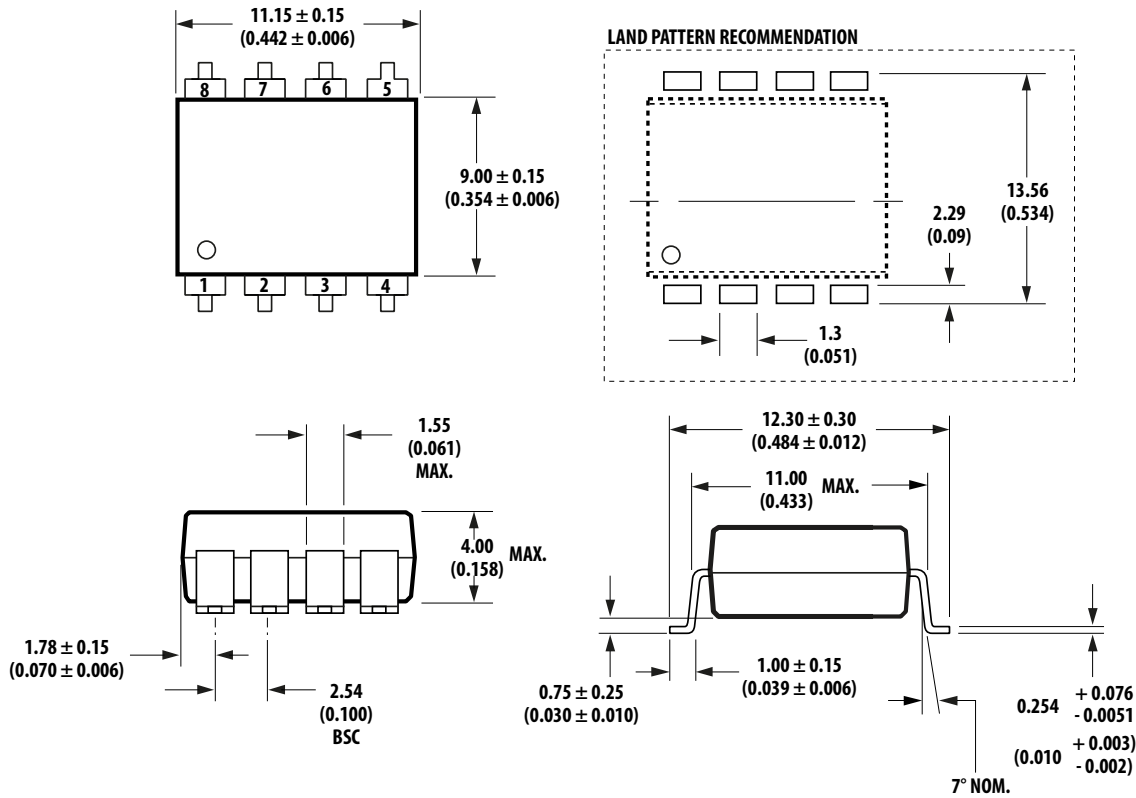

Dimensions in millimeters (inches).

Lead coplanarity = 0.10 mm (0.004 inches).

**NOTE** Floating lead protrusion is 0.25 mm (10 mils) maximum.

## Recommended Pb-Free IR Profile

Recommended reflow condition as per JEDEC Standard, J-STD-020 (latest revision). Non-Halide Flux should be used.

## Regulatory Information

The ACNW3430 is approved by the following organizations:

<b>UL</b>	Recognized under UL 1577, component recognition program up to $V_{ISO} = 5000 V_{RMS}$ , File E55361
<b>CSA</b>	CSA Component Acceptance Notice #5, File CA 88324
<b>IEC/EN/DIN EN 60747-5-5</b>	Maximum Working Insulation Voltage $V_{IORM} = 1414 V_{peak}$

**Table 1. IEC/EN/DIN EN 60747-5-5 Insulation Characteristics (see Note 1)**

Description	Symbol	Characteristic	Unit
Installation classification per DIN VDE 0110/39, Table 1 for rated mains voltage $\leq 600 V_{RMS}$ for rated mains voltage $\leq 1000 V_{RMS}$		I – IV I – III	
Climatic Classification		40/105/21	
Pollution Degree (DIN VDE 0110/39)		2	
Maximum Working Insulation Voltage	$V_{IORM}$	1414	$V_{peak}$
Input to Output Test Voltage, Method b (see Note 1) $V_{IORM} \times 1.875 = V_{PR}$ , 100% Production Test with $t_m = 1$ sec, Partial discharge $< 5$ pC	$V_{PR}$	2652	$V_{peak}$
Input to Output Test Voltage, Method a (see Note 1) $V_{IORM} \times 1.6 = V_{PR}$ , Type and Sample Test, $t_m = 10$ sec, Partial discharge $< 5$ pC	$V_{PR}$	2262	$V_{peak}$
Highest Allowable Overvoltage (see Note 1) (Transient Overvoltage $t_{ini} = 60$ sec)	$V_{IOTM}$	8000	$V_{peak}$
Safety-limiting values – maximum values allowed in the event of a failure. Case Temperature Input Current Output Power	$T_S$ $I_{S, INPUT}$ $P_{S, OUTPUT}$	150 400 800	$^{\circ}C$ mA mW
Insulation Resistance at $T_S$ , $V_{IO} = 500$ V	$R_S$	$> 10^9$	$\Omega$

**NOTE**

1. Refer to IEC/EN/DIN EN 60747-5-5 Optoisolator Safety Standard section of the *Avago Regulatory Guide to Isolation Circuits*, AV02-2041EN for a detailed description of Method a and Method b partial discharge test profiles.
2. These optocouplers are suitable for “safe electrical isolation” only within the safety limit data. Maintenance of the safety data shall be ensured by means of protective circuits. Surface mount classification is Class A in accordance with CECC 00802.

**Table 2. Insulation and Safety Related Specifications**

Parameter	Symbol	ACNW3430	Units	Conditions
Minimum External Air Gap (Clearance)	L(101)	9.6	mm	Measured from input terminals to output terminals, shortest distance through air.
Minimum External Tracking (Creepage)	L(102)	10.0	mm	Measured from input terminals to output terminals, shortest distance path along body.
Minimum Internal Plastic Gap (Internal Clearance)		1.0	mm	Through insulation distance conductor to conductor, usually the straight line distance thickness between the emitter and detector.
Tracking Resistance (Comparative Tracking Index)	CTI	> 200	V	DIN IEC 112/VDE 0303 Part 1
Isolation Group		IIIa		Material Group (DIN VDE 0110, 1/89, Table 1)

**NOTE** All Avago data sheets report the creepage and clearance inherent to the optocoupler component itself. These dimensions are needed as a starting point for the equipment designer when determining the circuit insulation requirements. However, once mounted on a printed circuit board, minimum creepage and clearance requirements must be met as specified for individual equipment standards. For creepage, the shortest distance path along the surface of a printed circuit board between the solder fillets of the input and output leads must be considered (the recommended Land Pattern does not necessarily meet the minimum creepage of the device). There are recommended techniques, such as grooves and ribs, that may be used on a printed circuit board to achieve desired creepage and clearances. Creepage and clearance distances will also change depending on factors, such as pollution degree and insulation level.

**Table 3. Absolute Maximum Ratings**

Parameter	Symbol	Min.	Max.	Units	Note
Storage Temperature	$T_S$	-55	125	°C	
Operating Temperature	$T_A$	-40	105	°C	
Average Input Current	$I_{F(AVG)}$		25	mA	a
Peak Transient Input Current (<1 ms pulse width, 300pps)	$I_{F(TRAN)}$		1	A	
Reverse Input Voltage	$V_R$		5	V	
“High” Peak Output Current	$I_{OH(PEAK)}$		5.0	A	b
“Low” Peak Output Current	$I_{OL(PEAK)}$		5.0	A	b
Total Output Supply Voltage	$(V_{CC} - V_{EE})$	-0.5	35	V	
Negative Output Supply Voltage	$(V_E - V_{EE})$	-0.5	15	V	
Positive Output Supply Voltage	$(V_{CC} - V_E)$	-0.5	$35 - (V_E - V_{EE})$	V	
Output Voltage	$V_{O(PEAK)}$	-0.5	$V_{CC}$	V	
Output IC Power Dissipation	$P_O$		800	mW	c
Total Power Dissipation	$P_T$		850	mW	d

- Derate linearly above 70 °C free-air temperature at a rate of 0.3 mA/°C.
- Maximum pulse width = 10  $\mu$ s. This value is intended to allow for component tolerances for designs with  $I_{OH}$  peak minimum = 4 A. See the Applications section for additional details on limiting  $I_{OH}$  peak.
- Derate linearly above 85 °C free-air temperature at a rate of 20 mW/°C.
- Derate linearly above 85 °C free-air temperature at a rate of 21.25 mW/°C. The maximum LED junction temperature should not exceed 125 °C.

**Table 4. Recommended Operating Conditions**

Parameter	Symbol	Min	Max.	Units	Note
Operating Temperature	$T_A$	-40	105	°C	
Output Supply Voltage	$(V_{CC} - V_{EE})$	15	30	V	
Negative Output Supply Voltage	$(V_E - V_{EE})$	0	15	V	
Positive Output Supply Voltage	$(V_{CC} - V_E)$	15	$30 - (V_E - V_{EE})$	V	
Input Current (ON)	$I_{F(ON)}$	8	12	mA	
Input Voltage (OFF)	$V_{F(OFF)}$	-3.6	0.5	V	

**Table 5. Electrical Specifications (DC)**

All typical values are at  $T_A = 25\text{ }^\circ\text{C}$ ,  $V_{CC} - V_E = 15\text{ V}$ ,  $V_E - V_{EE} = 15\text{ V}$ . All minimum and maximum specifications are at recommended operating conditions ( $T_A = -40\text{ }^\circ\text{C}$  to  $105\text{ }^\circ\text{C}$ ,  $I_{F(ON)} = 8\text{ mA}$  to  $12\text{ mA}$ ,  $V_{F(OFF)} = -3.6\text{ V}$  to  $0.5\text{ V}$ ,  $V_{CC} - V_E = 15\text{ V}$ ,  $V_E - V_{EE} = 15\text{ V}$ ), unless otherwise noted.

Parameter	Symbol	Min.	Typ.	Max.	Units	Test Conditions	Fig.	Note
High Level Peak Output Current	$I_{OH}$	-4.0	-7.5		A	$V_{CC} - V_O = 15$	2, 3	a
Low Level Peak Output Current	$I_{OL}$	4.0	6.2		A	$V_O - V_{EE} = 15$	5, 6	a
High Output Transistor RDS(ON)	$R_{DS,OH}$	0.5	1.2	2.1	$\Omega$	$I_{OH} = 4\text{ A}$	7	b
Low Output Transistor RDS(ON)	$R_{DS,OL}$	0.2	0.65	1.3	$\Omega$	$I_{OL} = -4\text{ A}$	8	b
High Level Output Voltage	$V_{OH}$	$V_{CC} - 0.3$	$V_{CC} - 0.12$		V	$I_O = -100\text{ mA}$	1	c, d
High Level Output Voltage	$V_{OH}$		$V_{CC}$		V	$I_O = 0\text{ mA}$ , $I_F = 10\text{ mA}$		
Low Level Output Voltage	$V_{OL}$		0.09	0.25	V	$I_O = 100\text{ mA}$	4	
High Level Output Supply Current ( $V_{CC}$ )	$I_{CCH}$		3	5	mA	$I_F = 10\text{ mA}$	9	
Low Level Output Supply Current ( $V_{CC}$ )	$I_{CCL}$		3	5	mA	$V_F = 0\text{ V}$	9	
$V_E$ High Level Output Supply Current	$I_{EH}$	-1.3	-0.9		mA	$I_F = 10\text{ mA}$	10	
$V_E$ Low Level Output Supply Current	$I_{EL}$	-1.0	-0.7		mA	$V_F = 0\text{ V}$	10	
Threshold Input Current Low to High	$I_{FLH}$	0.50	2.5	6	mA	$V_O > 5\text{ V}$	11, 12	
Threshold Input Voltage High to Low	$V_{FHL}$	0.5			V			
Input Forward Voltage	$V_F$	1.20	1.45	1.85	V	$I_F = 10\text{ mA}$		
Temperature Coefficient of Input Forward Voltage	$\Delta V_F / \Delta T_A$		-1.5		mV/ $^\circ\text{C}$	$I_F = 10\text{ mA}$		
Input Reverse Breakdown Voltage	$BV_R$	5			V	$I_R = 100\text{ mA}$		
Input Capacitance	$C_{IN}$		23		pF	$f = 1\text{ MHz}$ , $V_F = 0\text{ V}$		
UVLO Threshold	$V_{UVLO+}$	11.9	12.6	13.2	V	$V_O > 5\text{ V}$ , $I_F = 10\text{ mA}$		
	$V_{UVLO-}$	10.9	11.6	12.2				
UVLO Hysteresis	$UVLO_{HYS}$		1.0		V			

- Maximum pulse width = 10 ms.
- Output is sourced at -4.0 A/4.0 A with a maximum pulse width = 10  $\mu\text{s}$ .
- In this test,  $V_{OH}$  is measured with a dc load current. When driving capacitive loads,  $V_{OH}$  will approach  $V_{CC}$  as  $I_{OH}$  approaches zero amps.
- Maximum pulse width = 1 ms.



## Table 6. Switching Specifications (AC)

All typical values are at  $T_A = 25\text{ }^\circ\text{C}$ ,  $V_{CC} - V_E = 15\text{ V}$ ,  $V_E - V_{EE} = 15\text{ V}$ . All minimum and maximum specifications are at recommended operating conditions ( $T_A = -40\text{ }^\circ\text{C}$  to  $105\text{ }^\circ\text{C}$ ,  $I_{F(ON)} = 8$  to  $12\text{ mA}$ ,  $V_{F(OFF)} = -3.6\text{ V}$  to  $0.5\text{ V}$ ,  $V_{CC} - V_E = 15\text{ V}$ ,  $V_E - V_{EE} = 15\text{ V}$ ), unless otherwise noted.

Parameter	Symbol	Min.	Typ.	Max.	Units	Test Conditions	Fig.	Note
Propagation Delay Time to High Output Level	$t_{PLH}$	50	75	150	ns	$R_G = 7.5\ \Omega$ , $C_G = 25\text{ nF}$ , $f = 10\text{ kHz}$ , Duty Cycle = 50%, $I_F = 10\text{ mA}$ ,	13, 14, 17	
Propagation Delay Time to Low Output Level	$t_{PHL}$	50	68	150	ns			
Pulse Width Distortion	PWD			80	ns		17	a
Propagation Delay Difference Between Any Two Parts	PDD ( $t_{PHL} - t_{PLH}$ )	-90		90	ns		17	b
Propagation Delay Skew	$t_{PSK}$			80	ns		17	c
Rise Time	$t_R$		20	50	ns		15, 17	
Fall Time	$t_F$		10	30	ns			
Output High Level Common Mode Transient Immunity	$ CM_H $	100			kV/ $\mu\text{s}$	$T_A = 25\text{ }^\circ\text{C}$ , $I_F = 10\text{ mA}$ , $V_{CM} = 1500\text{ V}$ ,	18	d, e
Output Low Level Common Mode Transient Immunity	$ CM_L $	100			kV/ $\mu$	$T_A = 25\text{ }^\circ\text{C}$ , $V_F = 0\text{ V}$ , $V_{CM} = 1500\text{ V}$		d, f

- Pulse Width Distortion (PWD) is defined as  $|t_{PHL} - t_{PLH}|$  for any given device.
- The difference between  $t_{PHL}$  and  $t_{PLH}$  between any two ACNW3430 parts under the same test condition.
- $t_{PSK}$  is equal to the worst case difference in  $t_{PHL}$  or  $t_{PLH}$  that will be seen between units at any given temperature and specified test conditions.
- Pin 1 and 4 need to be connected to LED common. Split resistor network in the ratio 1:1 with  $178\ \Omega$  at the anode and  $178\ \Omega$  at the cathode.
- Common mode transient immunity in the high state is the maximum tolerable  $dV_{CM}/dt$  of the common mode pulse,  $V_{CM}$ , to assure that the output will remain in the high state (i.e.,  $V_O > 15.0\text{ V}$ ).
- Common mode transient immunity in a low state is the maximum tolerable  $dV_{CM}/dt$  of the common mode pulse,  $V_{CM}$ , to assure that the output will remain in a low state (i.e.,  $V_O < 1.0\text{ V}$ ).

## Table 7. Package Characteristics

All typical values are at  $T_A = 25^\circ\text{C}$ . All minimum/maximum specifications are at recommended operating conditions, unless otherwise noted.

Parameter	Symbol	Min.	Typ.	Max.	Units	Test Conditions	Fig.	Note
Input-Output Momentary Withstand Voltage <sup>a</sup>	$V_{ISO}$	5000			$V_{RMS}$	RH < 50%, t = 1 min., $T_A = 25^\circ\text{C}$		b, c
Input-Output Resistance	$R_{I-O}$		$10^{12}$		$\Omega$	$V_{I-O} = 500 V_{DC}$		c
Input-Output Capacitance	$C_{I-O}$		0.5		pF	f = 1 MHz		
LED-to-Ambient Thermal Resistance	$R_{11}$		139		$^\circ\text{C}/\text{W}$	Thermal Model in Application Notes Below		d
LED-to-Detector Thermal Resistance	$R_{12}$		25.3					
Detector-to-LED Thermal Resistance	$R_{21}$		40.2					
Detector-to-Ambient Thermal Resistance	$R_{22}$		87.5					

- The Input-Output Momentary Withstand Voltage is a dielectric voltage rating that should not be interpreted as an input-output continuous voltage rating. For the continuous voltage rating, refer to your equipment level safety specification or Avago Technologies Application Note 1074, *Optocoupler Input-Output Endurance Voltage*.
- In accordance with UL1577, each optocoupler is proof tested by applying an insulation test voltage  $\geq 6000 V_{RMS}$  for 1 second (leakage detection current limit,  $I_{I-O} \leq 5 \mu\text{A}$ ).
- The device is considered to be a two-terminal device: pins 1, 2, 3, and 4 shorted together and pins 5, 6, 7, and 8 shorted together.
- The device was mounted on a high conductivity test board as per JEDEC 51-7.

Figure 1  $V_{OH}$  vs. Temperature

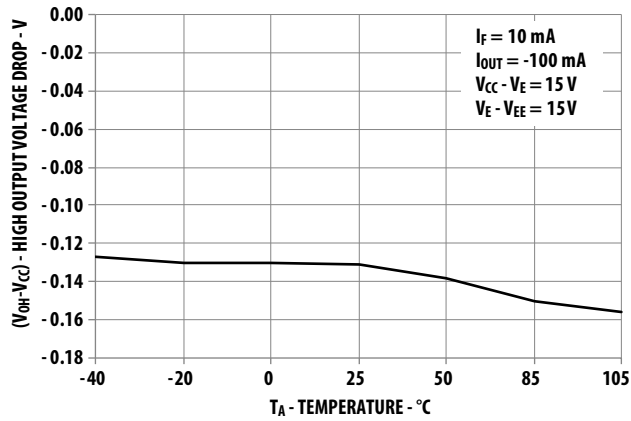

Figure 2  $I_{OH}$  vs. Temperature

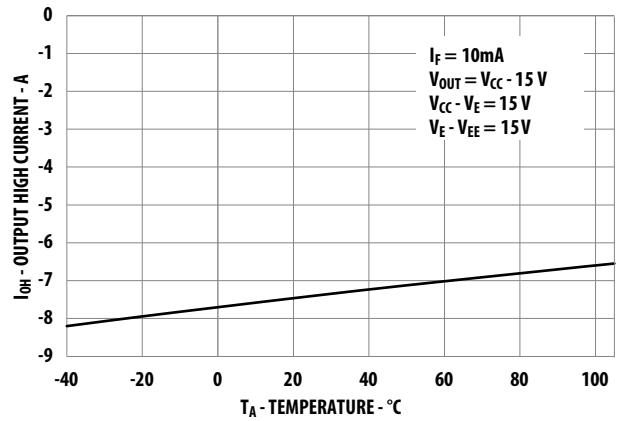

Figure 3  $I_{OH}$  vs.  $V_{OH}$

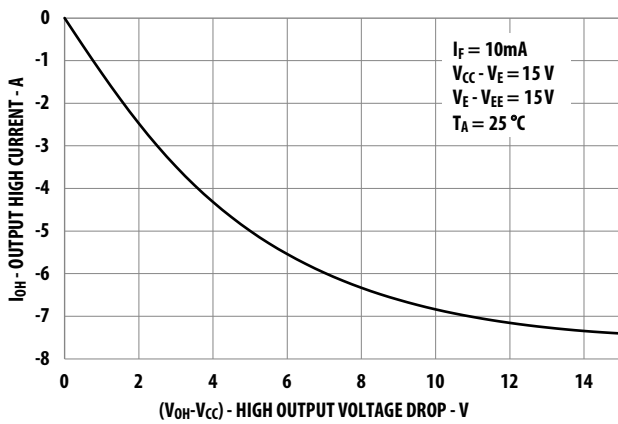

Figure 4  $V_{OL}$  vs. Temperature

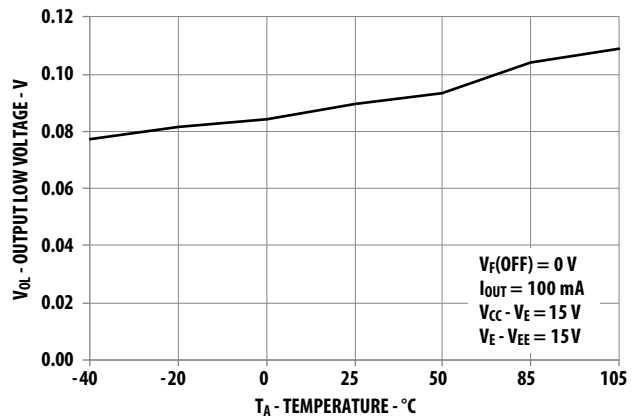

Figure 5  $I_{OL}$  vs. Temperature

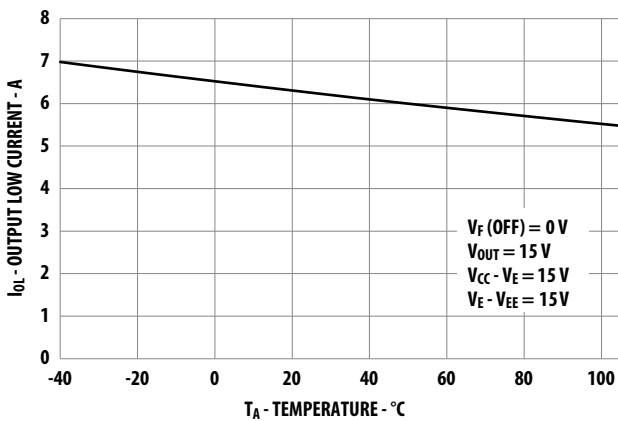

Figure 6  $I_{OL}$  vs.  $V_{OL}$

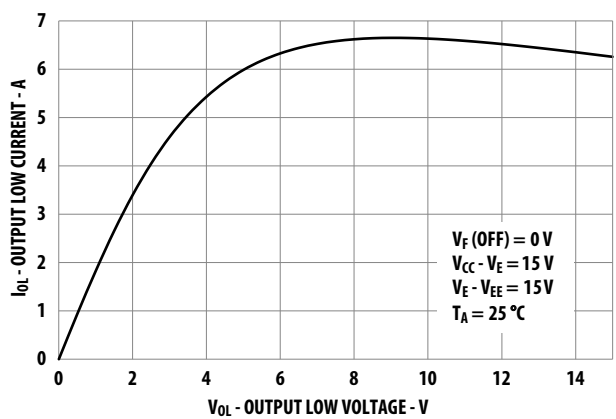

Figure 7  $R_{DS,OH}$  vs. Temperature

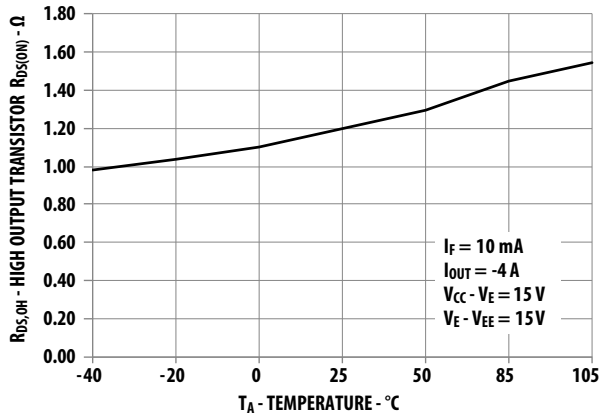

Figure 8  $R_{DS,OL}$  vs. Temperature

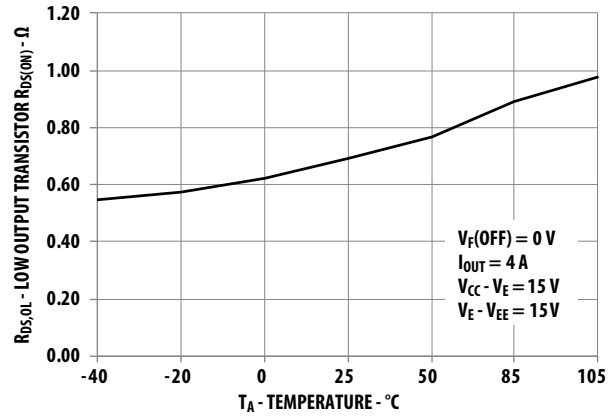

Figure 9  $I_{CC}$  vs. Temperature

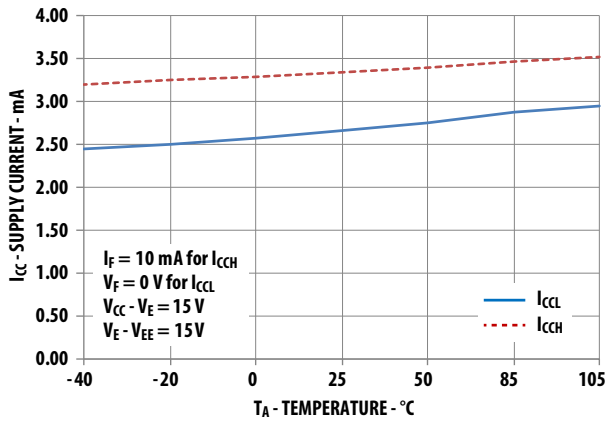

Figure 10  $I_E$  vs. Temperature

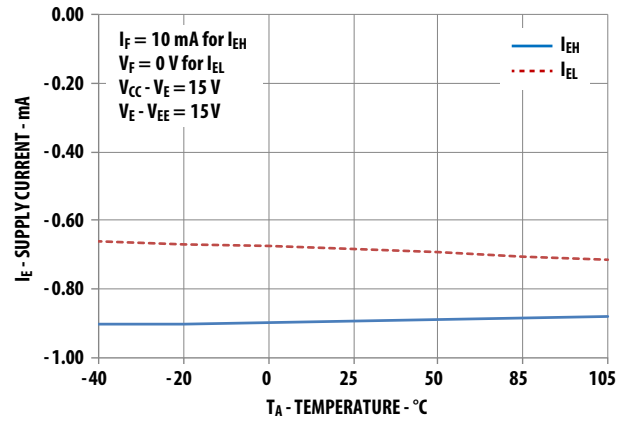

Figure 11  $I_{FLH}$  Hysteresis

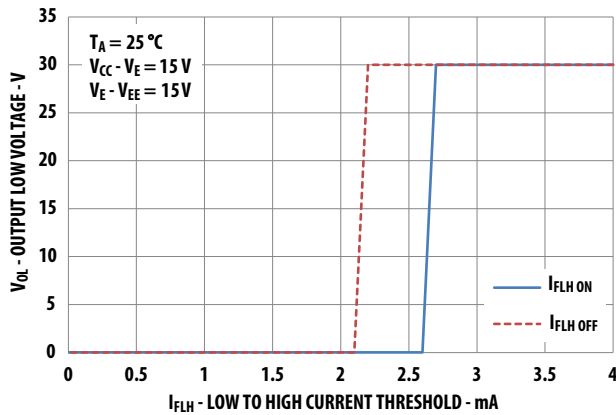

Figure 12  $I_{FLH}$  vs. Temperature

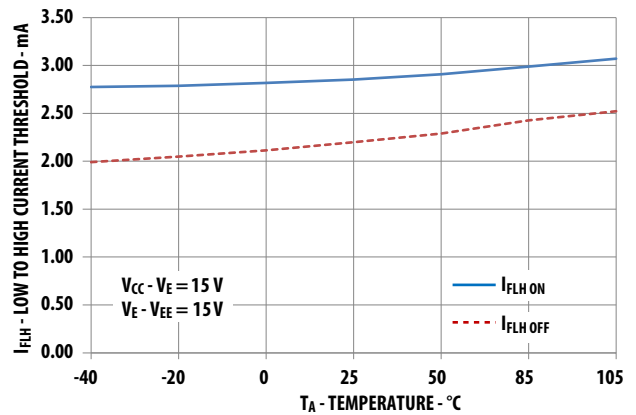

Figure 13 Propagation Delay vs.  $I_F$

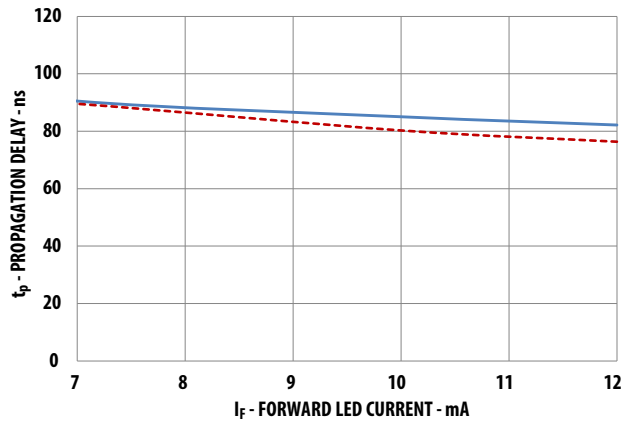

Figure 14 Propagation Delay vs. Temperature

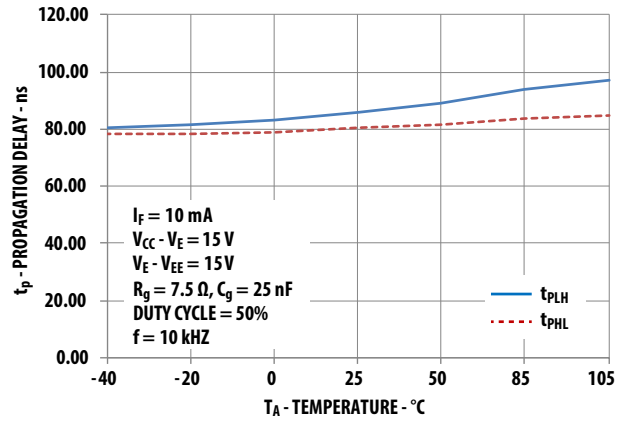

Figure 15 Rise and Fall Time vs. Temperature

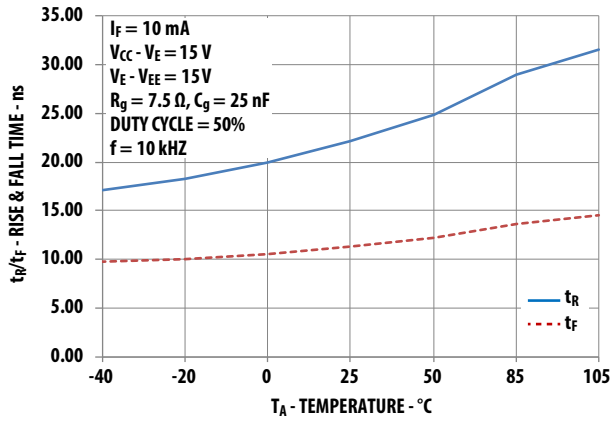
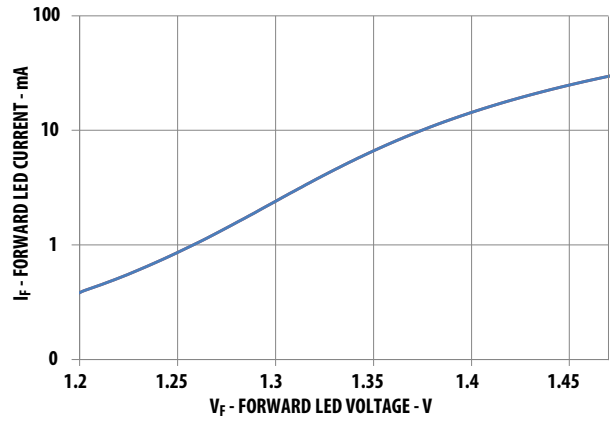
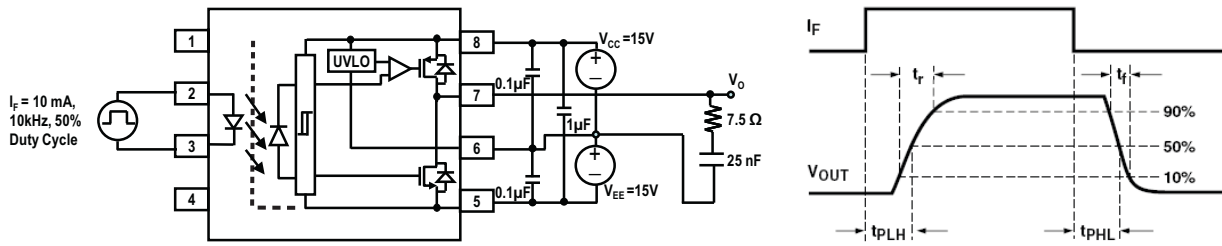

Figure 16 Input Current vs. Forward Voltage



**Figure 17**  $t_{PLH}$ ,  $t_{PHL}$ , PWD PDD,  $t_{PSK}$ ,  $t_r$  and  $t_f$  Test Circuit and Waveforms



**Figure 18** CMR Test Circuit with Split Resistors Network and Waveforms

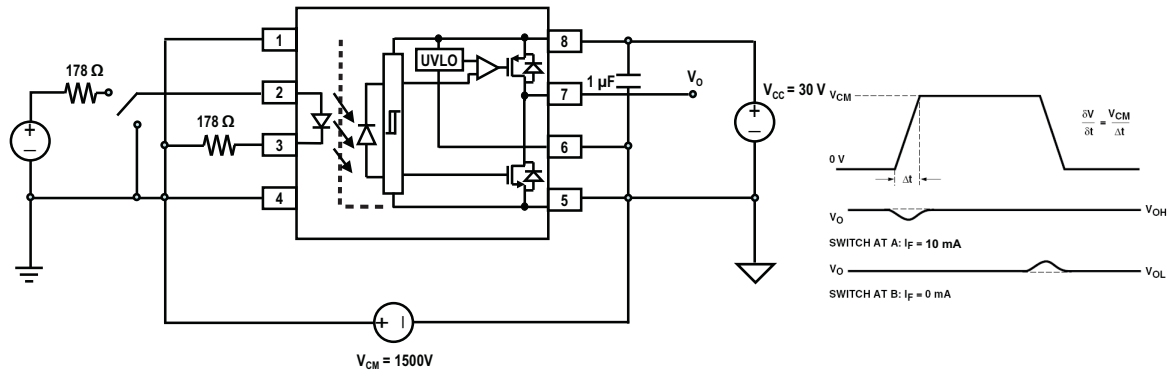

## Application Information

### Product Overview Description

The ACNW3430 is an optically isolated power output stage capable of driving IGBT or power MOSFET. Based on BCDMOS technology, this gate drive optocoupler delivers higher peak output current, better rail-to-rail output voltage performance and faster speed than the previous generation products.

The high peak output current and short propagation delay are needed for fast IGBT switching to reduce dead time and improve system overall efficiency. Rail-to-rail output voltage ensures that the MOSFET's gate voltage is driven to the optimum intended level with no power loss across the MOSFET. This helps the designer lower the system power which is suitable for bootstrap power supply operation.

The ACNW3430 has a  $V_E$  pin that allows of use negative power supply without affecting the UVLO monitoring the positive power supply. It has very high CMR (common mode rejection) rating which allows the microcontroller and the MOSFET to operate at very large common mode noise found in industrial motor drives and other power switching applications. The input is driven by direct LED current and has a hysteresis that prevents output oscillation if insufficient LED driving current is applied. This will eliminates the need of additional Schmitt trigger circuit at the input LED.

### Recommended Application Circuit

The recommended application circuit shown in Figure 19 illustrates a typical gate drive implementation using the ACNW3430.

The supply bypass capacitors provide the large transient currents necessary during a switching transition. Because of the transient nature of the charging currents, a low current (5.0 mA) power supply will be enough to power the device. The split resistors (in the ratio of 1:1) across the LED will provide a high CMR response by providing a balanced resistance network across the LED. Connect pin 1 and pin 4 to LED common.

The gate resistor  $R_G$  serves to limit gate charge current and controls the IGBT switching times.

In PC board design, care should be taken to avoid routing the IGBT's collector or emitter traces close to the ACNW3430 input as this can result in unwanted coupling of transient signals into ACNW3430 and degrade performance.

**Figure 19 Recommended Application Circuit with Split Resistors LED Drive**

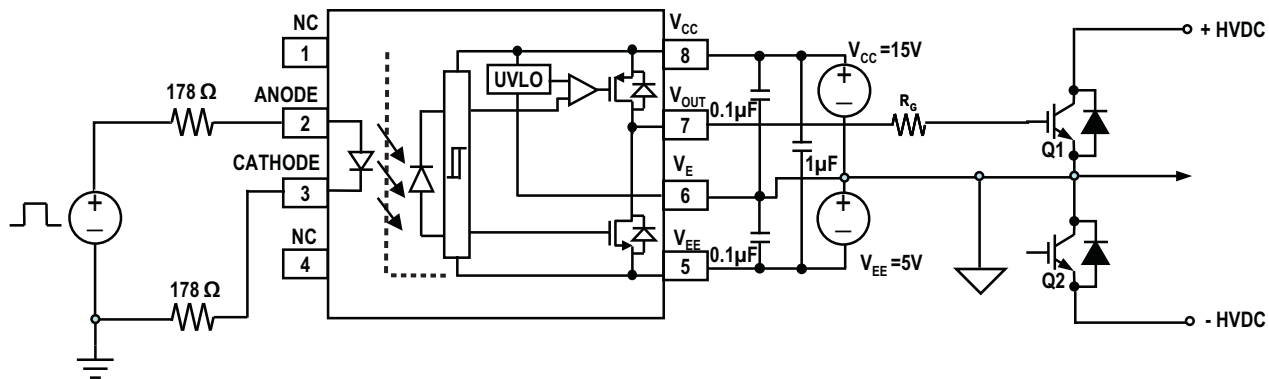

## Thermal Model for ACNW3430 400mil DIP-8 Package Optocoupler

Definitions:

- $R_{11}$ : Junction to Ambient Thermal Resistance of LED due to heating of LED  
 $R_{12}$ : Junction to Ambient Thermal Resistance of LED due to heating of Detector (Output IC)  
 $R_{21}$ : Junction to Ambient Thermal Resistance of Detector (Output IC) due to heating of LED.  
 $R_{22}$ : Junction to Ambient Thermal Resistance of Detector (Output IC) due to heating of Detector (Output IC).  
 $P_1$ : Power dissipation of LED (W).  
 $P_2$ : Power dissipation of Detector / Output IC (W).  
 $T_1$ : Junction temperature of LED (C).  
 $T_2$ : Junction temperature of Detector (C).  
 $T_A$ : Ambient temperature.

Ambient Temperature: Junction to Ambient Thermal Resistances were measured approximately 1.25 cm above the optocoupler at ~23 °C in still air.

Thermal Resistance	°C/W
$R_{11}$	139
$R_{12}$	25.3
$R_{21}$	40.2
$R_{22}$	87.5

This thermal model assumes that an 8-pin single-channel plastic package optocoupler is soldered into a 7.62 cm × 7.62 cm printed circuit board (PCB) per JEDEC standards. The temperature at the LED and Detector junctions of the optocoupler can be calculated using the following equations.

$$T_1 = (R_{11} * P_1 + R_{12} * P_2) + T_A \text{ -- (1)}$$

$$T_2 = (R_{21} * P_1 + R_{22} * P_2) + T_A \text{ -- (2)}$$

For product information and a complete list of distributors, please go to our web site:

[www.avagotech.com](http://www.avagotech.com)

Avago Technologies and the A logo are trademarks of Avago Technologies in the United States and other countries. All other brand and product names may be trademarks of their respective companies.

Data subject to change. Copyright © 2015–2016 Avago Technologies. All Rights Reserved.

AV02-4666EN – June 30, 2016

**AVAGO**  
TECHNOLOGIES





## Данный компонент на территории Российской Федерации

### Вы можете приобрести в компании MosChip.

Для оперативного оформления запроса Вам необходимо перейти по данной ссылке:

<http://moschip.ru/get-element>

Вы можете разместить у нас заказ для любого Вашего проекта, будь то серийное производство или разработка единичного прибора.

В нашем ассортименте представлены ведущие мировые производители активных и пассивных электронных компонентов.

Нашей специализацией является поставка электронной компонентной базы двойного назначения, продукции таких производителей как XILINX, Intel (ex.ALTERA), Vicor, Microchip, Texas Instruments, Analog Devices, Mini-Circuits, Amphenol, Glenair.

Сотрудничество с глобальными дистрибьюторами электронных компонентов, предоставляет возможность заказывать и получать с международных складов практически любой перечень компонентов в оптимальные для Вас сроки.

На всех этапах разработки и производства наши партнеры могут получить квалифицированную поддержку опытных инженеров.

Система менеджмента качества компании отвечает требованиям в соответствии с ГОСТ Р ИСО 9001, ГОСТ РВ 0015-002 и ЭС РД 009

### Офис по работе с юридическими лицами:

105318, г.Москва, ул.Щербаковская д.3, офис 1107, 1118, ДЦ «Щербаковский»

Телефон: +7 495 668-12-70 (многоканальный)

Факс: +7 495 668-12-70 (доб.304)

E-mail: [info@moschip.ru](mailto:info@moschip.ru)

Skype отдела продаж:

moschip.ru

moschip.ru\_4

moschip.ru\_6

moschip.ru\_9