

AT90-1413



Digital Attenuator
15 dB, 4-Bit, TTL Driver, DC-4.0 GHz

Rev. V9

Features

- Attenuation: 1 dB Steps to 15 dB
- Single Positive Supply
- Contains Internal DC to DC Converter
- Integral TTL Driver
- 50 Ohm Impedance
- Test Boards Available
- Tape and Reel Packaging Available
- CSP-1 Package

Description

M/A-COM's AT90-1413 is a GaAs FET 4-Bit digital attenuator with integral driver. Step size is 1 dB providing a 15 dB attenuation range. This device is in an PQFN plastic surface mount package. The AT90-1413 is suited for single supply applications where accuracy, fast speed, low power consumption and low costs are required. For dual supply designs without switching noise, use AT90-0413.

Functional Schematic

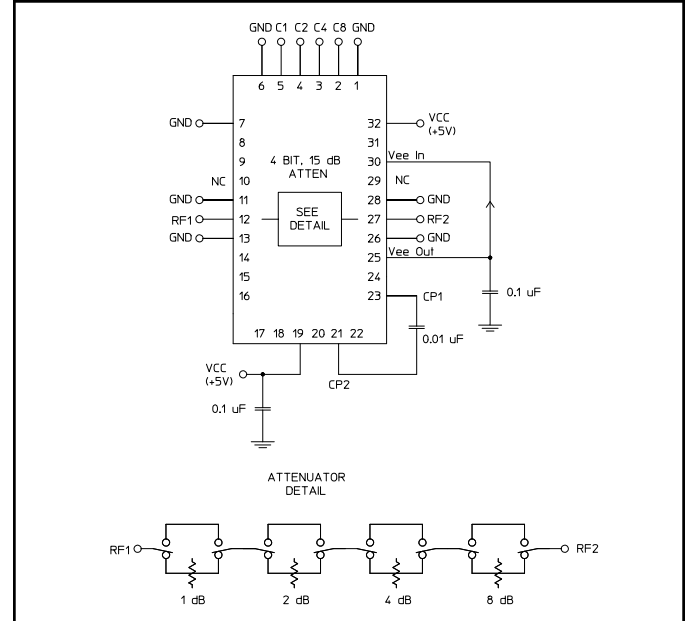

Pin Configuration

Pin No.	Function	Pin No.	Function
1	GND	17	NC
2	C8	18	NC
3	C4	19	Vcc
4	C2	20	N/C
5	C1	21	Cp
6	GND	22	NC
7	GND	23	Cp
8	NC	24	NC
9	NC	25	Vee ²
10	NC ¹	26	GND
11	GND	27	RF2
12	RF1	28	GND
13	GND	29	NC ¹
14	NC	30	Vee ²
15	NC	31	NC
16	NC	32	Vcc

1. Pins 10 & 29 must be isolated.
2. Vee is produced internally and requires a .1 μ F cap to GND. Generated noise is typical of switching DC-DC Converters.
3. The exposed pad centered on the package bottom must be connected to RF and DC ground. (For PQFN Packages)

Ordering Information

Part Number	Package
AT90-1413	Bulk Packaging
AT90-1413TR	1000 piece reel
AT90-1413-TB	Sample Test Board

Note: Reference Application Note M513 for reel size information.

ADVANCED: Data Sheets contain information regarding a product M/A-COM Technology Solutions is considering for development. Performance is based on target specifications, simulated results, and/or prototype measurements. Commitment to develop is not guaranteed.
PRELIMINARY: Data Sheets contain information regarding a product M/A-COM Technology Solutions has under development. Performance is based on engineering tests. Specifications are typical. Mechanical outline has been fixed. Engineering samples and/or test data may be available. Commitment to produce in volume is not guaranteed.

• **North America** Tel: 800.366.2266 • **Europe** Tel: +353.21.244.6400
• **India** Tel: +91.80.4155721 • **China** Tel: +86.21.2407.1588
Visit www.macomtech.com for additional data sheets and product information.

M/A-COM Technology Solutions Inc. and its affiliates reserve the right to make changes to the product(s) or information contained herein without notice.

Digital Attenuator 15 dB, 4-Bit, TTL Driver, DC-4.0 GHz

Rev. V9

Electrical Specifications: $T_A = 25^\circ\text{C}$, $Z_0 = 50\Omega$

Parameter	Test Conditions	Frequency	Units	Min	Typ	Max
Insertion Loss	—	DC-2.5 GHz	dB	—	2.0	2.5
		DC-4.0 GHz	dB	—	2.5	3.0
Attenuation Accuracy	Individual Bits or Combination of Bits	DC-2.5 GHz	dB	—	—	$\pm(0.3+4\%$ of atten setting)
		DC-4.0 GHz	dB	—	—	$\pm(0.3+6\%$ of atten setting)
VSWR	Full Attenuation Range	DC-2.5 GHz	Ratio	—	1.5:1	1.8:1
		DC-4.0 GHz	Ratio	—	1.8:1	2.0:1
Switching Speed	50% Cntl to 90%/10% RF 10% to 90% or 90% to 10%	—	ns	—	75	150
		—	ns	—	20	50
1 dB Compression	—	50 MHz	dBm	—	+21	—
		0.5-4.0 GHz	dBm	—	+29	—
Input IP_3	Two-tone Inputs up to +5 dBm	50 MHz	dBm	—	+35	—
		0.5-4.0 GHz	dBm	—	+48	—
V_{CC}	—	—	V	4.75	5.0	5.25
V_{IL} V_{IH}	LOW-level input voltage	—	V	0.0	—	0.8
	HIGH-level input voltage	—	V	2.0	—	5.0
I_{in} (Input Leakage Current)	$V_{in} = V_{CC}$ or GND	—	μA	-1.0	—	1.0
I_{CC}^4	V_{CC} min to max, Logic "0" or "1"	—	mA	—	6	10
Turn-on Current ⁵	For guaranteed start-up	—	mA	—	—	125
ΔI_{CC} (Additional Supply Current Per TTL Input Pin)	$V_{CC} = \text{Max}$, $V_{cntrl} = V_{CC} - 2.1 \text{ V}$	—	mA	—	—	1.0
Switching Noise	Generated from DC-DC Converter with recommended capacitors	3.5 MHz	dBm	—	-93	—
Thermal Resistance θ_{jc}	—	—	$^\circ\text{C/W}$	—	15	—

- During turn-on, the device requires an initial start up current (I_{CC}) specified as "Turn-on Current". Once operational, I_{CC} will drop to the specified levels.
- The DC-DC converter is guaranteed to start in 100 μs as long as the power supplies have the maximum turn-on current available for start-up.

Absolute Maximum Ratings ^{6,7}

Parameter	Absolute Maximum
Max. Input Power 0.05 GHz 0.5 - 4.0 GHz	+27 dBm +34 dBm
V_{CC}	$-0.5\text{V} \leq V_{CC} \leq +6.0\text{V}$
V_{in}^8	$-0.5\text{V} \leq V_{in} \leq V_{CC} + 0.5\text{V}$
Operating Temperature	-40°C to $+85^\circ\text{C}$
Storage Temperature	-65°C to $+125^\circ\text{C}$

- Exceeding any one or combination of these limits may cause permanent damage to this device.
- M/A-COM does not recommend sustained operation near these survivability limits.
- Standard CMOS TTL interface, latch-up will occur if logic signal is applied prior to power supply.

Recommended PCB Configuration⁹

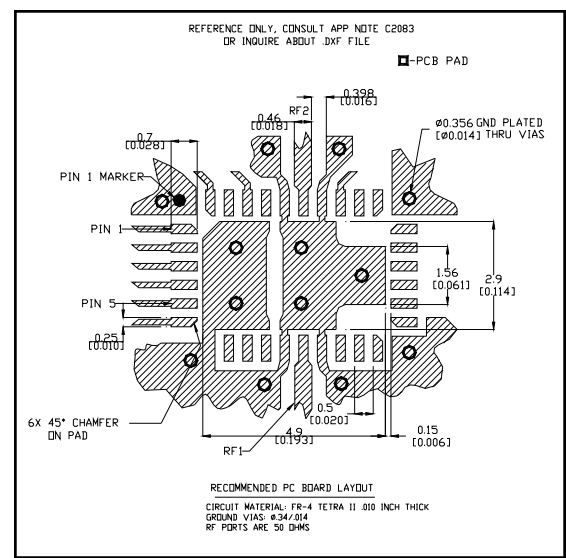

9. Application Note S2083 is available on line at www.macom.com

Handling Procedures

Please observe the following precautions to avoid damage:

Static Sensitivity

Gallium Arsenide Integrated Circuits are sensitive to electrostatic discharge (ESD) and can be damaged by static electricity. Proper ESD control techniques should be used when handling these devices.

Moisture Sensitivity

The MSL rating for this part is defined as Level 2 per IPC/JEDEC J-STD-020. Parts shall be stored and/or baked as required for MSL Level 2 parts.

Typical Performance Curves

Insertion Loss

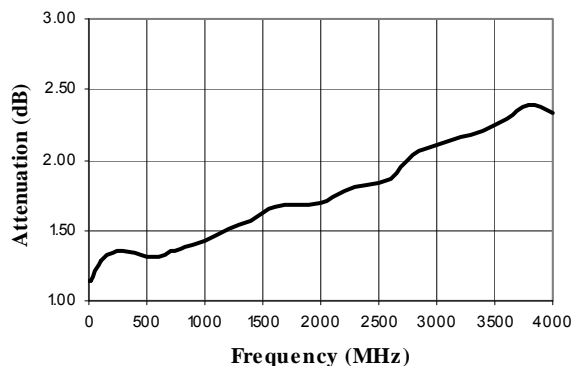

Attenuation Error, 1 dB Bit

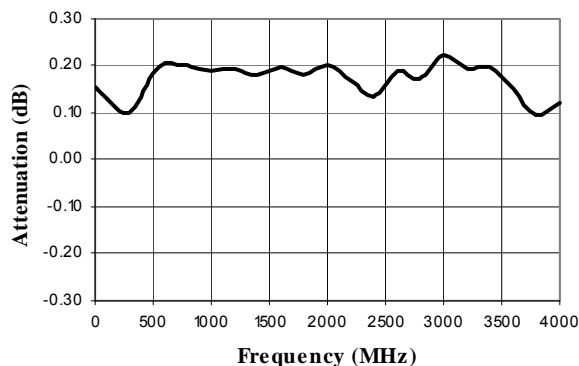

Truth Table (Digital Attenuator)

C8	C4	C2	C1	Attenuation
0	0	0	0	Loss, Reference
0	0	0	1	1.0 dB
0	0	1	0	2.0 dB
0	1	0	0	4.0 dB
1	0	0	0	8.0 dB
1	1	1	1	15.0 dB

0 = TTL Low; 1 = TTL High

VSWR @ Insertion Loss

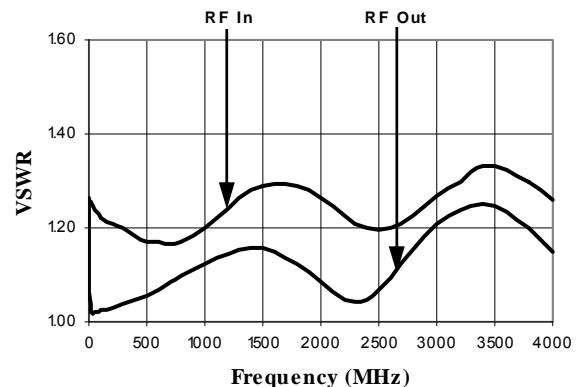

Attenuation Error, 2 dB Bit

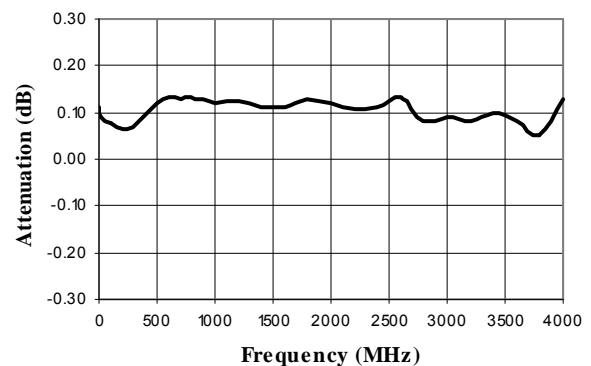

Typical Performance Curves

Attenuation Error, 4 dB Bit

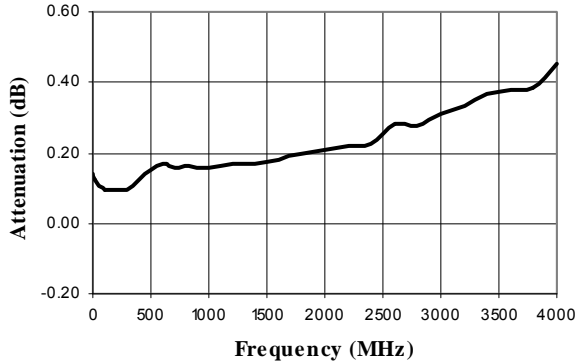

Attenuation Error, 8 dB Bit

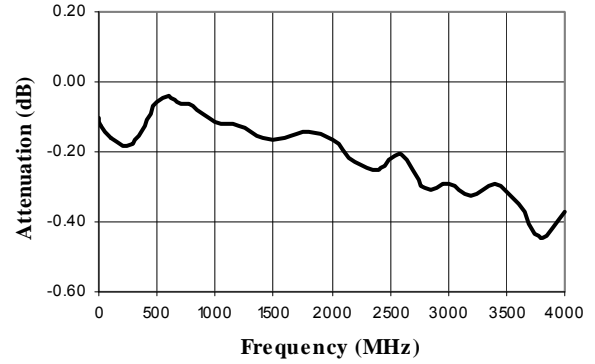

Attenuation Error, Max. Attenuation

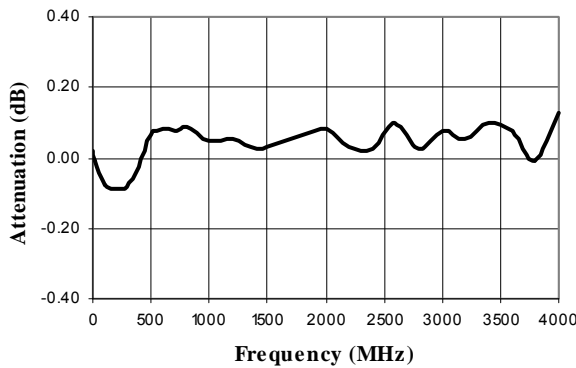

VSWR, 1 dB Bit

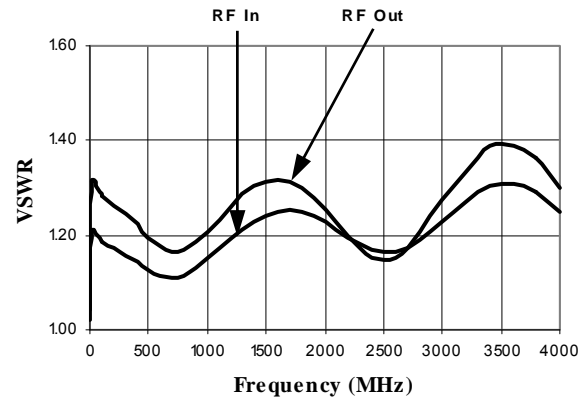

VSWR, 2 dB Bit

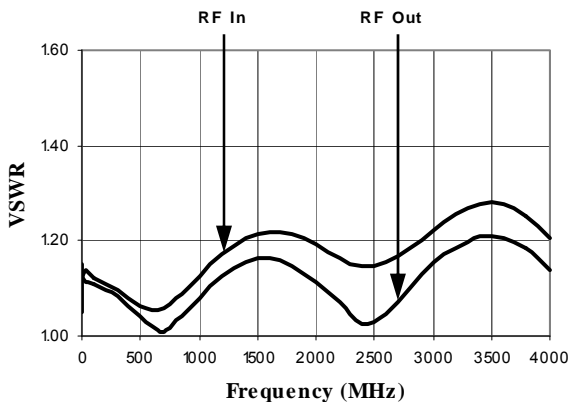

VSWR, 4 dB Bit

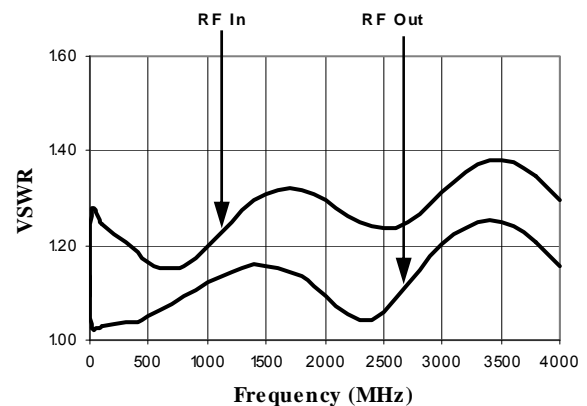

Typical Performance Curves

VSWR, 8 dB Bit

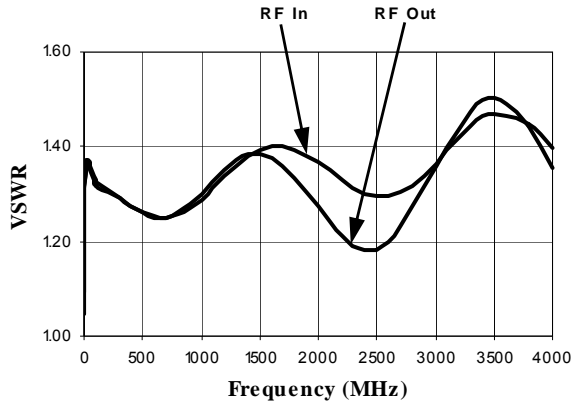

VSWR, Maximum Attenuation

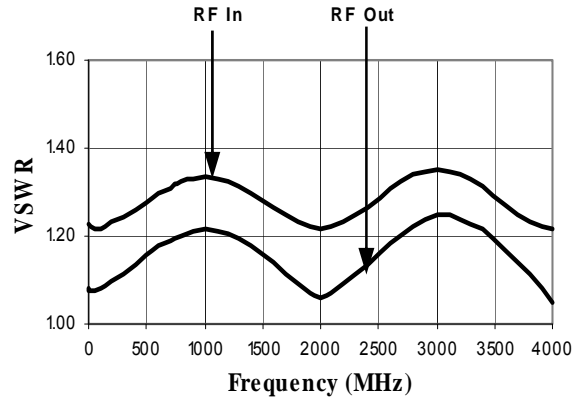

CSP-1, 4 x 6 mm, 32-lead PQFN†

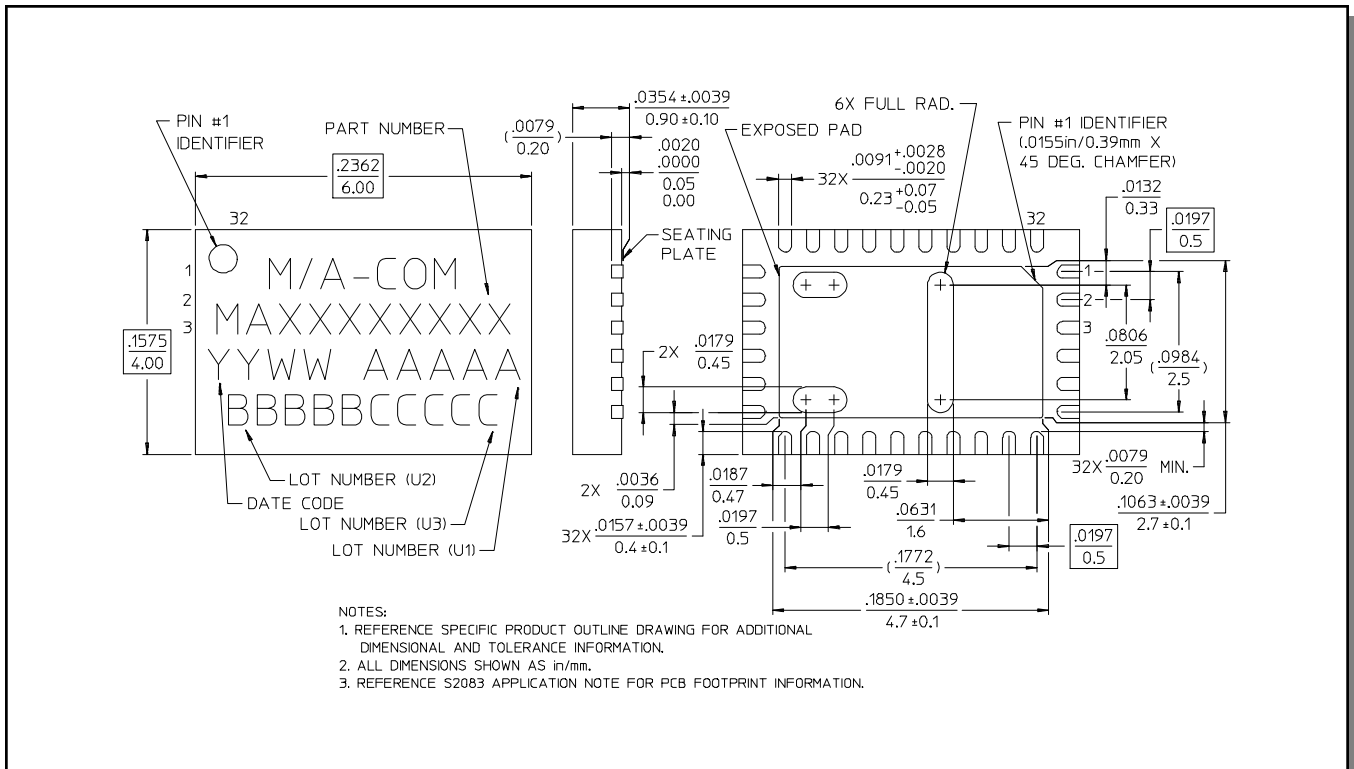

† Reference Application Note M538 for lead-free solder reflow recommendations.

Данный компонент на территории Российской Федерации

Вы можете приобрести в компании MosChip.

Для оперативного оформления запроса Вам необходимо перейти по данной ссылке:

<http://moschip.ru/get-element>

Вы можете разместить у нас заказ для любого Вашего проекта, будь то серийное производство или разработка единичного прибора.

В нашем ассортименте представлены ведущие мировые производители активных и пассивных электронных компонентов.

Нашей специализацией является поставка электронной компонентной базы двойного назначения, продукции таких производителей как XILINX, Intel (ex.ALTERA), Vicor, Microchip, Texas Instruments, Analog Devices, Mini-Circuits, Amphenol, Glenair.

Сотрудничество с глобальными дистрибьюторами электронных компонентов, предоставляет возможность заказывать и получать с международных складов практически любой перечень компонентов в оптимальные для Вас сроки.

На всех этапах разработки и производства наши партнеры могут получить квалифицированную поддержку опытных инженеров.

Система менеджмента качества компании отвечает требованиям в соответствии с ГОСТ Р ИСО 9001, ГОСТ РВ 0015-002 и ЭС РД 009

Офис по работе с юридическими лицами:

105318, г.Москва, ул.Щербаковская д.3, офис 1107, 1118, ДЦ «Щербаковский»

Телефон: +7 495 668-12-70 (многоканальный)

Факс: +7 495 668-12-70 (доб.304)

E-mail: info@moschip.ru

Skype отдела продаж:

moschip.ru

moschip.ru_4

moschip.ru_6

moschip.ru_9