

Comlinear[®] CLC1200

Instrumentation Amplifier

FEATURES

- $\pm 2.3\text{V}$ to $\pm 18\text{V}$ supply voltage range
- Gain range of 1 to 10,000
- Gain set with one external resistor
- $\pm 125\mu\text{V}$ maximum input offset voltage
- $0.1\mu\text{V}/^\circ\text{C}$ input offset drift
- 700kHz bandwidth at $G = 1$
- $1.2\text{V}/\mu\text{s}$ slew rate
- 90dB minimum CMRR at $G = 10$
- 2.2mA maximum supply current
- $6.6\text{nV}/\sqrt{\text{Hz}}$ input voltage noise
- $70\text{nV}/\sqrt{\text{Hz}}$ output voltage noise
- $0.2\mu\text{V}_{\text{pp}}$ noise (0.1Hz to 10Hz)
- DIP-8 or Pb-free SOIC-8

APPLICATIONS

- Bridge amplifier
- Scales
- Thermocouple amplifier
- ECG and medical instrumentation
- MRI (Magnetic Resonance Imaging)
- Patient Monitors
- Transducer interface
- Data acquisition systems
- Strain gauge amplifier
- Industrial process controls

General Description

The CLC1200 is a low power, general purpose instrumentation amplifier with a gain range of 1 to 10,000. The CLC1200 is offered in 8-lead SOIC or DIP packages and requires only one external gain setting resistor making it smaller and easier to implement than discrete, 3-amp designs.

While consuming only 2.2mA of supply current, the CLC1200 offers a low $6.6\text{nV}/\text{Hz}$ input voltage noise and $0.2\mu\text{V}_{\text{pp}}$ noise from 0.1Hz to 10Hz.

The CLC1200 offers a low input offset voltage of $\pm 125\mu\text{V}$ that only varies $0.1\mu\text{V}/^\circ\text{C}$ over its operating temperature range of -40°C to $+85^\circ\text{C}$. The CLC1200 also features 50ppm maximum nonlinearity. These features make it well suited for use in data acquisition systems.

Functional Block Diagram

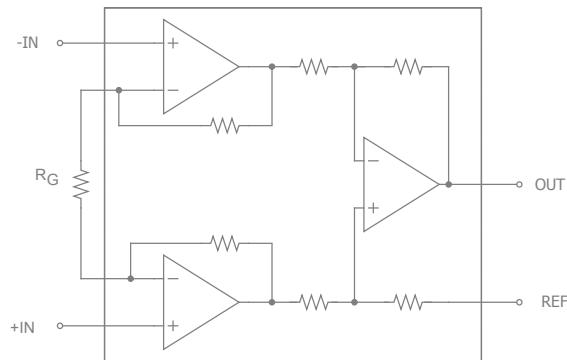

Competitive Comparison Plots (continued on page 9)

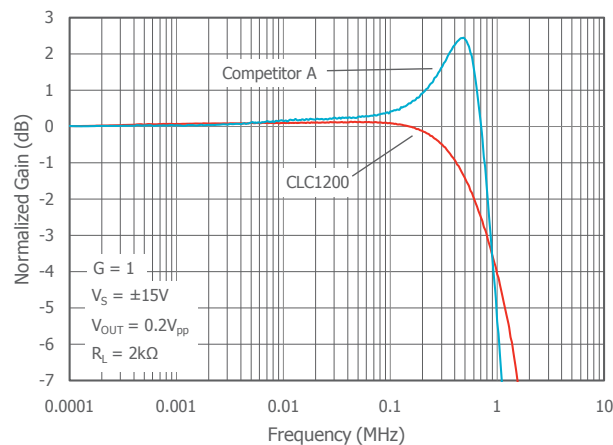

Ordering Information

Part Number	Package	Pb-Free	RoHS Compliant	Operating Temperature Range	Packaging Method
CLC1200ISO8	SOIC-8	Yes	Yes	-40°C to $+85^\circ\text{C}$	Rail
CLC1200ISO8X	SOIC-8	Yes	Yes	-40°C to $+85^\circ\text{C}$	Reel
CLC1200IDP8	DIP-8	Yes	Yes	-40°C to $+85^\circ\text{C}$	Rail

Moisture sensitivity level for all parts is MSL-1.

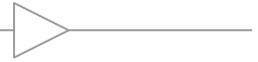

Pin Configuration

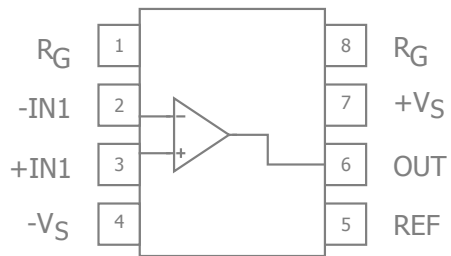

Pin Assignments

Pin No.	Pin Name	Description
1, 8	R _G	R _G sets gain
2	-IN	Negative input
3	+IN	Positive input
4	-V _S	Negative supply
5	REF	Output is referred to the REF pin potential
6	OUT	Output
7	+V _S	Positive supply



Electrical Characteristics

$T_A = 25^\circ\text{C}$, $V_S = \pm 15\text{V}$, $R_L = 2\text{k}\Omega$ to GND; unless otherwise noted.

$G = 1 + (49.4\text{k}\Omega / R_G)$; Total RTI Error = $V_{OSI} + (V_{OSO} / G)$

Symbol	Parameter	Conditions	Min	Typ	Max	Units
Gain						
	Gain Range		1		10,000	
	Gain Error	$G = 1, V_{OUT} = \pm 10\text{V}$	-0.1		0.1	%
		$G = 10, V_{OUT} = \pm 10\text{V}$	-0.375		0.375	%
		$G = 100, V_{OUT} = \pm 10\text{V}$	-0.375		0.375	%
		$G = 1,000, V_{OUT} = \pm 10\text{V}$	-0.8		0.8	%
	Nonlinearity	$G = 1 - 100, V_{OUT} = -10\text{V to } 10\text{V}, R_L = 10\text{k}\Omega$		10	50	ppm
		$G = 1 - 100, V_{OUT} = -10\text{V to } 10\text{V}, R_L = 2\text{k}\Omega$		10	95	ppm
	Gain vs. Temperature	$G = 1$		<10		ppm/ $^\circ\text{C}$
		$G > 1$			<-50	
	Reference Gain Error ⁽²⁾	$V_S = \pm 16.5$	-0.03		0.03	%
Voltage Offset						
V_{OSI}	Input Offset Voltage	$V_S = \pm 4.5$ to ± 16.5	-125		125	μV
	Average Temperature Coefficient	$V_S = \pm 4.5$ to ± 16.5		0.1		$\mu\text{V}/^\circ\text{C}$
V_{OSO}	Output Offset Voltage	$V_S = \pm 4.5$ to $\pm 16.5, G = 1$	-1500	200	1500	μV
	Average Temperature Coefficient	$V_S = \pm 4.5$ to ± 16.5		2.5		$\mu\text{V}/^\circ\text{C}$
PSR	Offset Referred to the Input vs. Supply	$G = 1, V_S = \pm 2.3$ to $\pm 18\text{V}$	80	100		dB
		$G = 10, V_S = \pm 2.3$ to $\pm 18\text{V}$	95	120		dB
		$G = 100, V_S = \pm 2.3$ to $\pm 18\text{V}$	110	140		dB
		$G = 1,000, V_S = \pm 2.3$ to $\pm 18\text{V}$	110	140		dB
Input Current						
I_B	Input Bias Current	$V_S = \pm 16.5$	-2	0.5	2	nA
	Average Temperature Coefficient	$V_S = \pm 16.5$		3		$\text{pA}/^\circ\text{C}$
I_{OS}	Input Offset Current	$V_S = \pm 16.5$	-1		1	nA
Input						
	Input Impedance	Differential		10, 2		$\text{G}\Omega, \text{pF}$
		Common-Mode		10, 2		$\text{G}\Omega, \text{pF}$
	Input Voltage Range ⁽³⁾	$V_S = \pm 4.5, G = 1$	$-V_S + 1.9$		$+V_S - 1.2$	V
		$V_S = \pm 16.5, G = 1$	$-V_S + 1.9$		$+V_S - 1.4$	V
CMRR	Common Mode Rejection Ratio	$G = 1, V_S = \pm 16.5\text{V}$	70	90		dB
		$G = 10, V_S = \pm 16.5\text{V}$	90	110		dB
		$G = 100, V_S = \pm 16.5\text{V}$	108	130		dB
		$G = 1,000, V_S = \pm 16.5\text{V}$	108	130		dB
Output						
V_{OUT}	Output Swing	$V_S = \pm 2.3\text{V to } \pm 4.5\text{V}$	$-V_S + 1.1$		$+V_S - 1.2$	V
		$V_S = \pm 18, G = 1$	$-V_S + 1.4$		$+V_S - 1.2$	V
I_{SC}	Short Circuit Current			± 20		mA
Dynamic Performance						
$BW_{-3\text{dB}}$	Small Signal Bandwidth	$G = 1$		700		kHz
		$G = 10$		400		kHz
		$G = 100$		100		kHz
		$G = 1,000$		12		kHz
SR	Slew Rate	$G = 10, V_S = \pm 15\text{V}$	0.6	1.2		$\text{V}/\mu\text{s}$



Symbol	Parameter	Conditions	Min	Typ	Max	Units
t_s	Settling Time to 0.01%	$G = 1$ to 100, 5V step		13		μs
		$G = 1,000$, 5V step		110		μs
e_{ni}	Input Voltage Noise	1kHz, $G = 1,000$, $V_S = \pm 15V$		6.6	13	nV/\sqrt{Hz}
e_{no}	Output Voltage Noise	1kHz, $G = 1$, $V_S = \pm 15V$		70	100	nV/\sqrt{Hz}
RTI	RTI, 0.1Hz to 10Hz	$G = 1$		5		μV_{pp}
		$G = 10$, $V_S = \pm 15V$			0.8	μV_{pp}
		$G = 100$, $V_S = \pm 15V$		0.2	0.4	μV_{pp}
	Current Noise	$f = 1kHz$		100		fA/\sqrt{Hz}
		0.1Hz to 10Hz		10		pA_{pp}
Reference Input						
R_{IN}	Input Impedance			20		$k\Omega$
I_{IN}	Input Current	$V_S = \pm 16.5V$		50	60	μA
	Voltage Range	$V_S = \pm 15V$	$-V_S + 1.6$		$+V_S - 1.6$	V
	Gain to Output		1 \pm 0.0001			
Power Supply						
V_S	Operating Range		± 2.3		± 18	V
I_S	Supply Current	$V_S = \pm 16.5V$		1.3	2.2	mA

Notes:

- 100% tested at 25°C
- Nominal reference voltage gain is 1.0
- Input voltage range = $CMV + (G V_{DIFF})/2$



Absolute Maximum Ratings

The safety of the device is not guaranteed when it is operated above the "Absolute Maximum Ratings". The device should not be operated at these "absolute" limits. Adhere to the "Recommended Operating Conditions" for proper device function. The information contained in the Electrical Characteristics tables and Typical Performance plots reflect the operating conditions noted on the tables and plots.

Parameter	Min	Max	Unit
Supply Voltage	0	±18	V
Input Voltage Range	-V _S	+V _S	V
Differential Input Voltage, G = 1 to 10		25	V
Differential Input Voltage, G > 10		≤ 0.05 (R _G + 800) + 1	V
Load Resistance	0.001		kΩ

Reliability Information

Parameter	Min	Typ	Max	Unit
Junction Temperature			150	°C
Storage Temperature Range	-65		150	°C
Lead Temperature (Soldering, 10s)			260	°C
Package Thermal Resistance				
8-Lead SOIC		100		°C/W
8-Lead DIP		TBD		°C/W

Notes:

Package thermal resistance (θ_{JA}), JEDEC standard, multi-layer test boards, still air.

ESD Protection

Product	SOIC-8	DIP-8
Human Body Model (HBM)	1.5kV	TBD
Charged Device Model (CDM)	2kV	TBD

Recommended Operating Conditions

Parameter	Min	Typ	Max	Unit
Operating Temperature Range	-40		+85	°C
Supply Voltage Range	±2.3		±18	V



Typical Performance Characteristics

$T_A = 25^\circ\text{C}$, $V_S = \pm 15\text{V}$, $R_L = 2\text{k}\Omega$ to GND; unless otherwise noted.

Input Offset Distribution (typical)

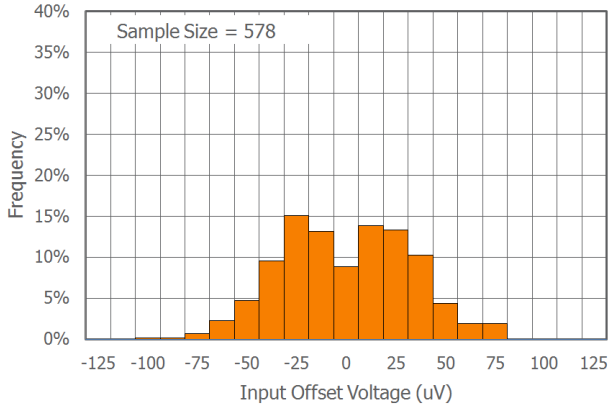

Input Bias Current Distribution (typical)

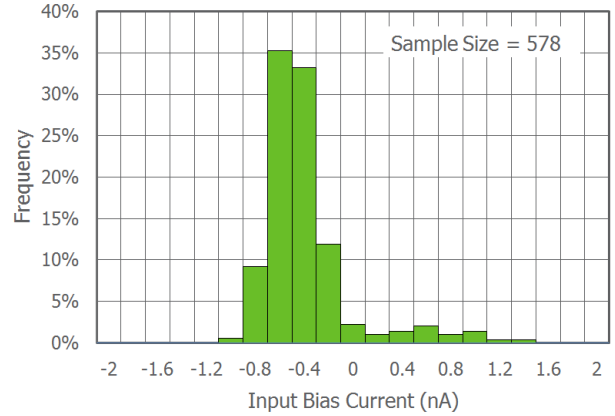

Input Offset Distribution (typical)

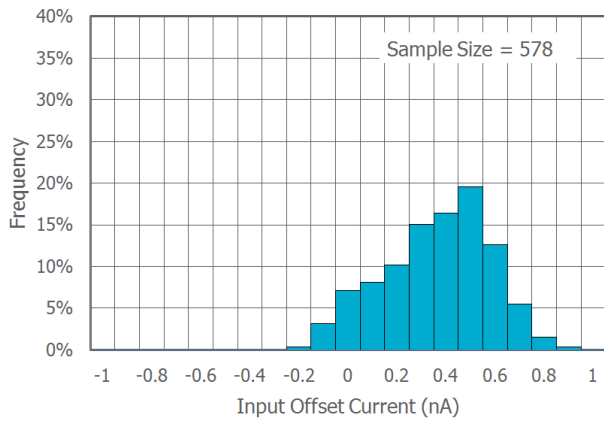



Typical Performance Characteristics

$T_A = 25^\circ\text{C}$, $V_S = \pm 15\text{V}$, $R_L = 2\text{k}\Omega$ to GND; unless otherwise noted.

Gain vs. Frequency

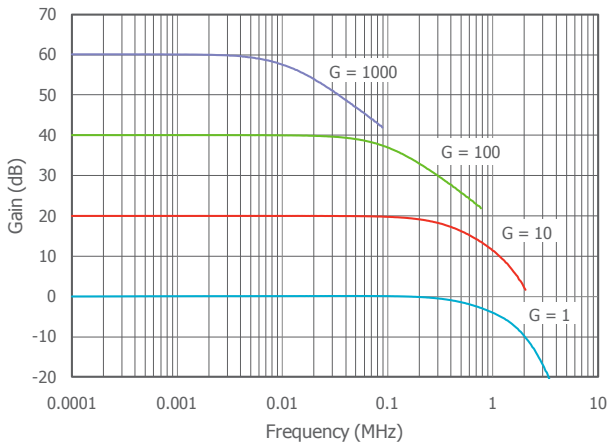

Output Voltage Swing vs. V_S

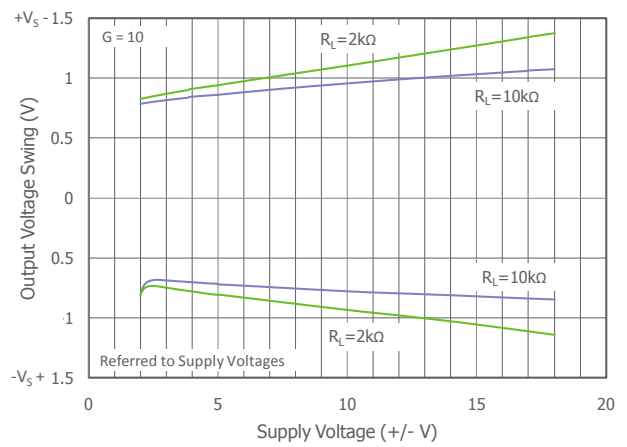

Input Voltage Range vs. V_S

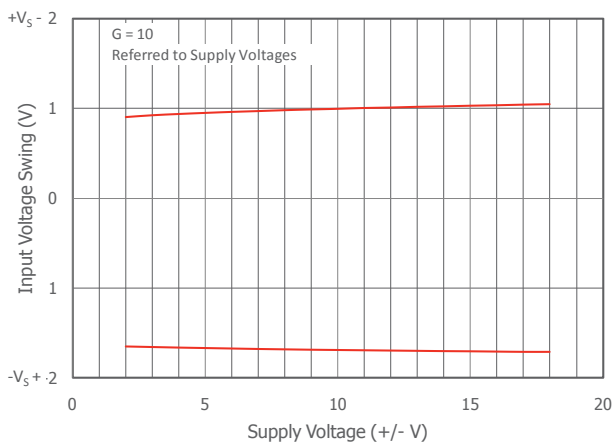

Output Voltage Swing vs. R_L

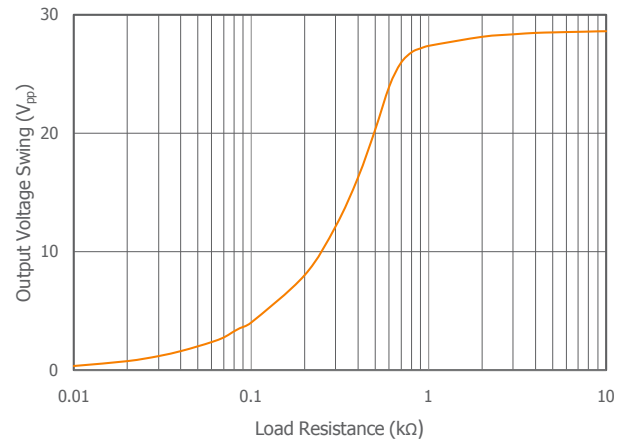

Large Signal Pulse Response ($G = 1$)

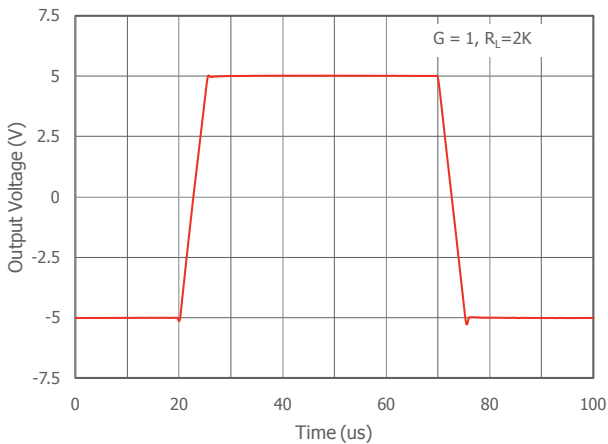

Large Signal Settling Time ($G = 1$)

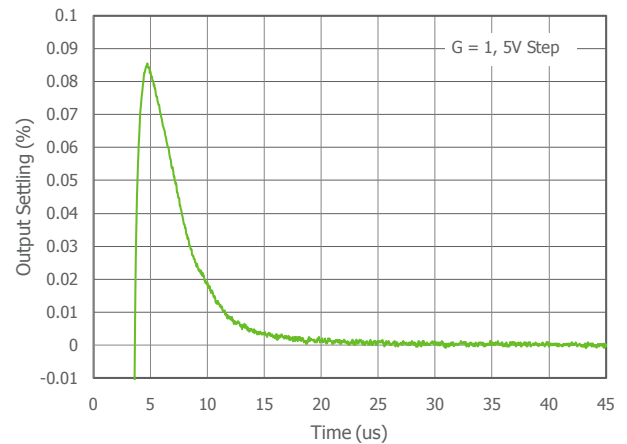



Typical Performance Characteristics

$T_A = 25^\circ\text{C}$, $V_S = \pm 15\text{V}$, $R_L = 2\text{k}\Omega$ to GND; unless otherwise noted.

Large Signal Pulse Response (G = 10)

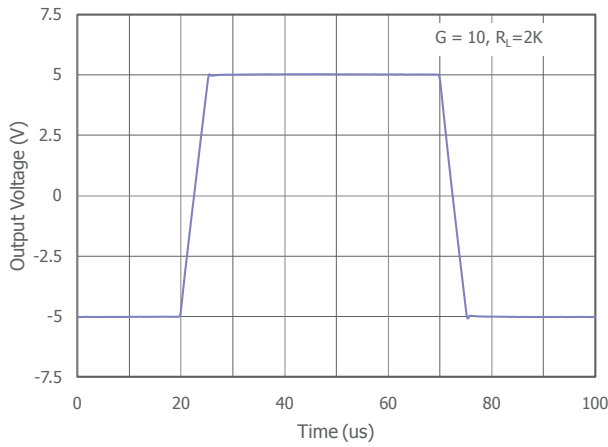

Large Signal Settling Time (G = 10)

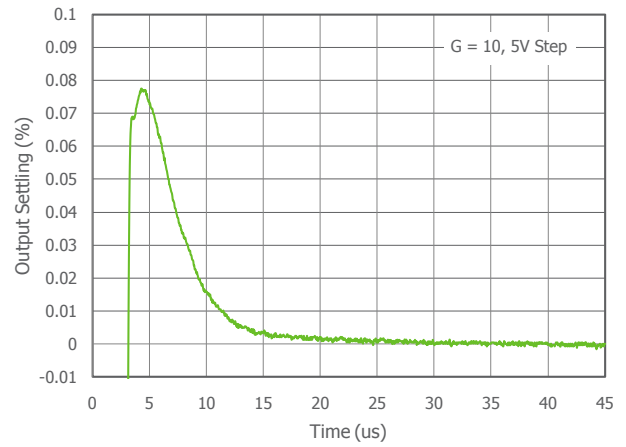

Large Signal Pulse Response (G = 100)

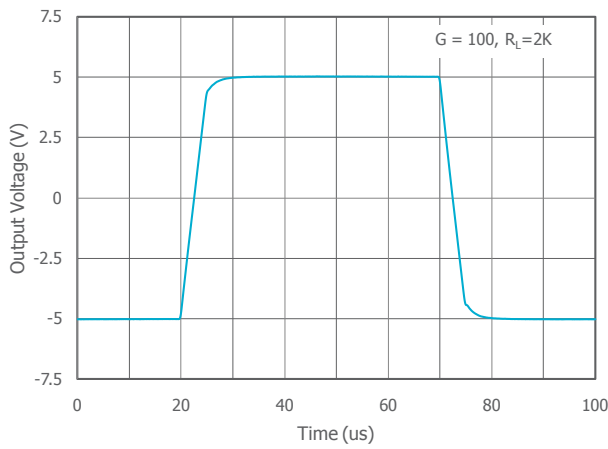

Large Signal Settling Time (G = 100)

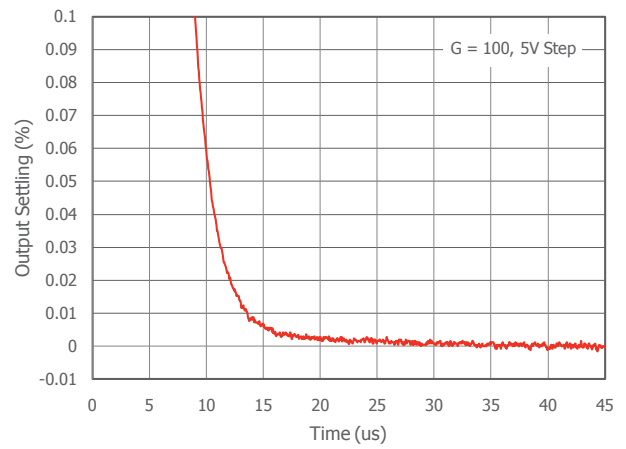

Large Signal Pulse Response (G = 1000)

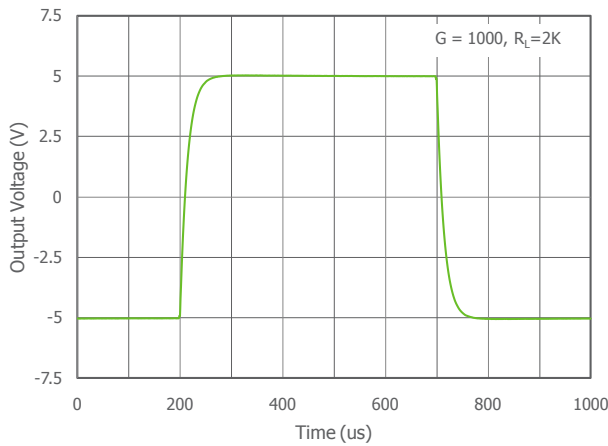

Large Signal Settling Time (G = 1000)

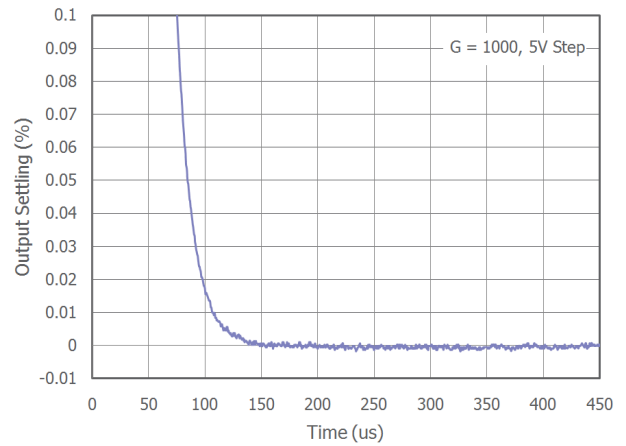



Typical Performance Characteristics

$T_A = 25^\circ\text{C}$, $V_S = \pm 15\text{V}$, $R_L = 2\text{k}\Omega$ to GND; unless otherwise noted.

Small Signal Pulse Response ($G = 1$)

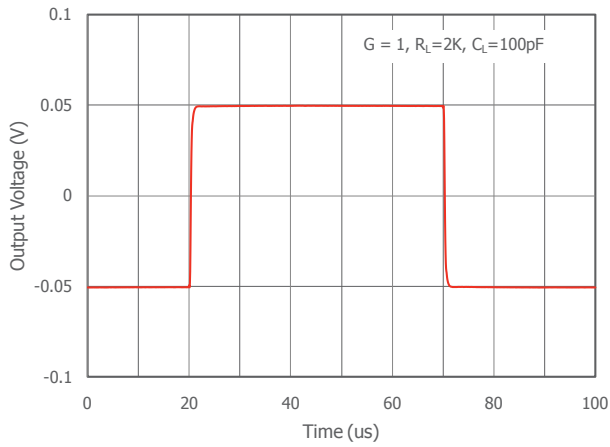

Small Signal Pulse Response ($G = 10$)

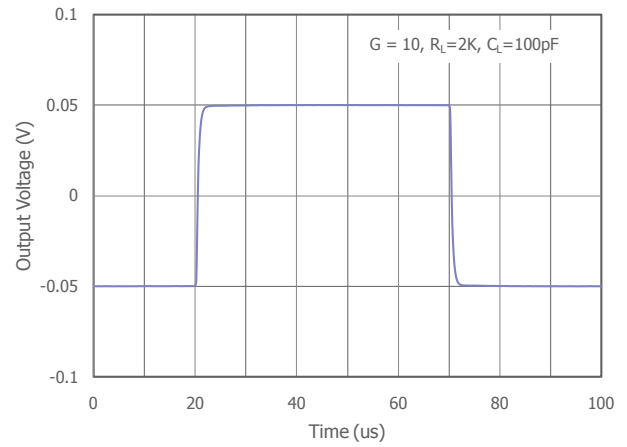

Small Signal Pulse Response ($G = 100$)

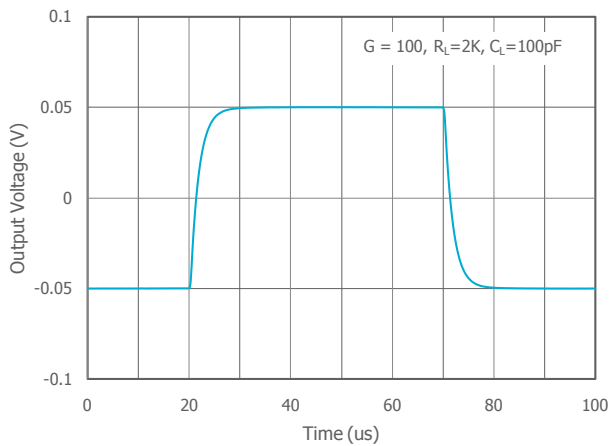

Small Signal Pulse Response ($G = 1000$)

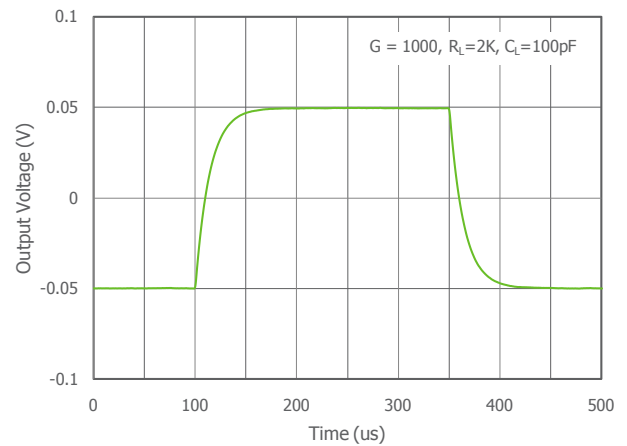



Typical Competitive Comparison Plots

$T_A = 25^\circ\text{C}$, $V_S = \pm 15\text{V}$, $R_L = 2\text{k}\Omega$, CADEKA evaluation board; unless otherwise noted.

Frequency Response ($G = 1$)

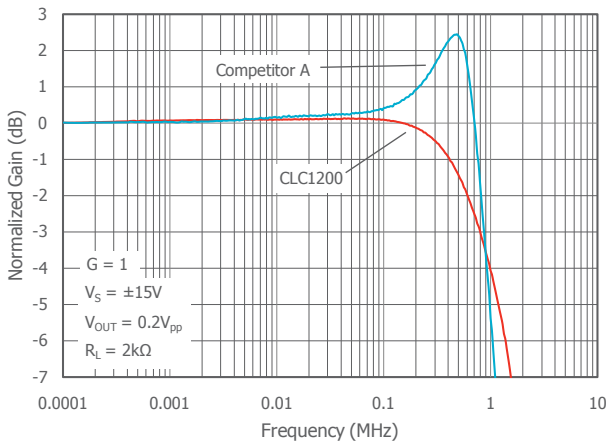

Frequency Response ($G = 10$)

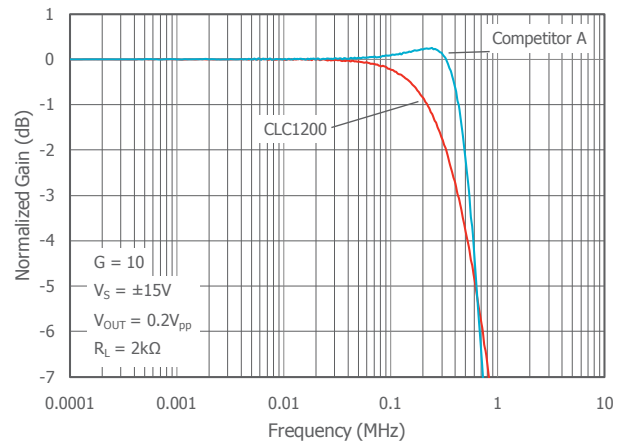

Frequency Response ($G = 100$)

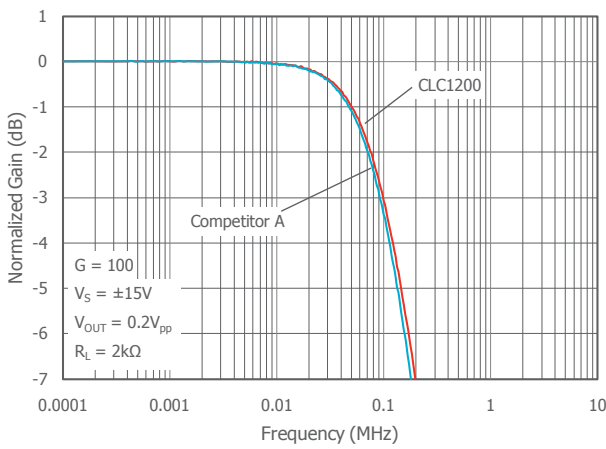

Frequency Response ($G = 1,000$)

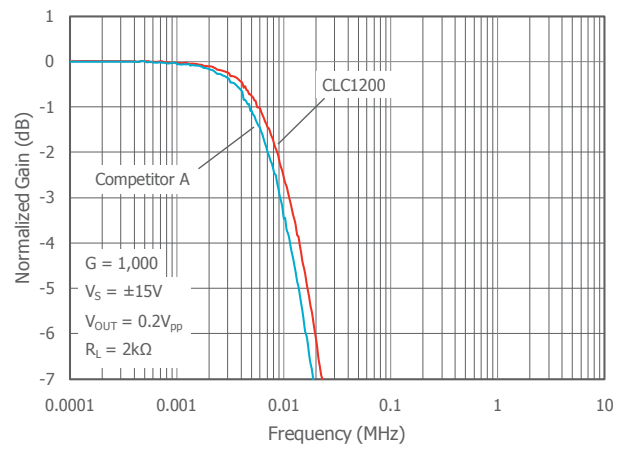

Large Signal Settling Time ($G = 1$)

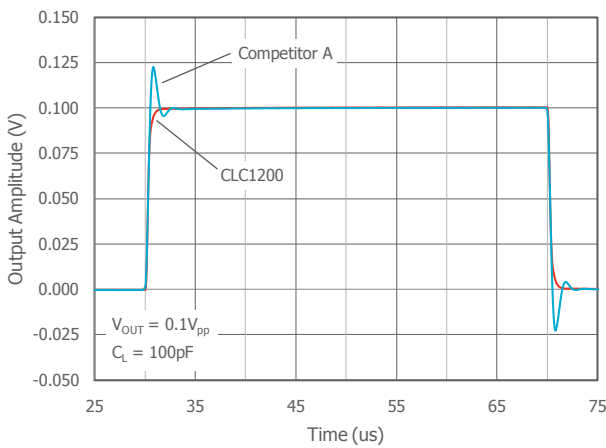

Large Signal Settling Time ($G = 10$)

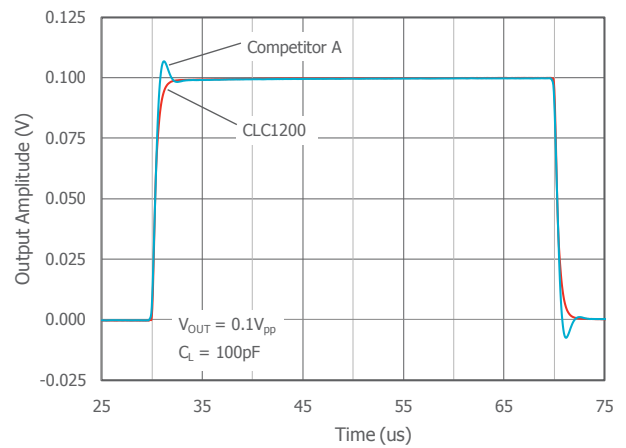



Application Information

Basic Operation

The CLC1200 is a monolithic instrumentation amplifier based on the classic three op amp solution, refer to the Functional Block Diagram on page 1. The CLC1200 produces a single-ended output referred to the REF pin potential.

The internal resistors are trimmed which allows the gain to be accurately adjusted with one external resistor R_G .

$$G = \frac{49.4k}{R_G} + 1; \quad R_G = \frac{49.4k}{G - 1}$$

R_G also determines the transconductance of the preamp stage. As R_G is reduced for larger gains, the transconductance increases to that of the input transistors. Producing the following advantages:

- Open-loop gain increases as the gain is increased, reducing gain related errors
- Gain-bandwidth increases as the gain is increased, optimizing frequency response
- Reduced input voltage noise which is determined by the collector current and base resistance of the input devices

Gain Selection

The impedance between pins 1 and 8, R_G , sets the gain of the CLC1200. Table 1 shows the required standard table values of R_G for various calculated gains. For $G = 1$, $R_G = \infty$.

1% R_G (Ω)	Calculated Gain	0.1% R_G (Ω)	Calculated Gain
49.9k	1.990	49.3k	2.002
12.4k	4.984	12.4k	4.984
5.49k	9.998	5.49k	9.998
2.61k	19.93	2.61k	19.93
1.00k	50.40	1.01k	49.91
499	100.0	499	100.0
249	199.4	249	199.4
100	495.0	98.8	501.0
49.9	991.0	49.3	1,003.0

Table 1: Recommended R_G Values

Follow these guidelines for improved performance:

- To maintain gain accuracy, use 0.1% to 1% resistors
- To minimize gain error, avoid high parasitic resistance in series with R_G
- To minimize gain drift, use low TC resistors (<10ppm/°C)

Common Mode Rejection

The CLC1200 offers high CMRR. To achieve optimal CMRR performance:

- Connect the reference terminal (pin 5) to a low impedance source
- Minimize capacitive and resistive differences between the inputs

In many applications, shielded cables are used to minimize noise. Properly drive the shield for best CMRR performance over frequency. Figures 1 and 2 show active data guards that are configured to improve AC common-mode rejections. the capacitances of input cable shields are "bootstrapped" to minimize the capacitance mismatch between the inputs.

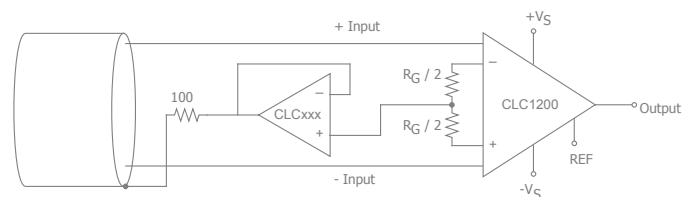

Figure 1: Common-mode Shield Driver

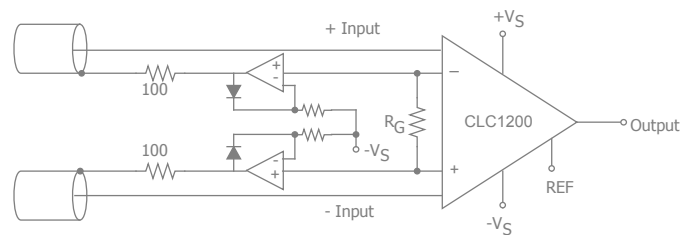

Figure 2: Differential Shield Driver



Pressure Measurement Applications

The CLC1200 is especially suitable for higher resistance pressure sensors powered at lower voltages where small size and low power become more significant.

Figure 3 shows a 3kΩ pressure transducer bridge powered from 5V. In such a circuit, the bridge consumes only 1.7mA. Adding the CLC1200 and a buffered voltage divider allows the signal to be conditioned for only 3.8mA of total supply current.

Small size and low cost make the CLC1200 especially attractive for voltage output pressure transducers. Since it delivers low noise and drift, it will also serve applications such as diagnostic noninvasive blood pressure measurement.

Medical ECG

The CLC1200 is perfect for ECG monitors because of its low current noise. A typical application is shown in Figure 4. The CLC1200's low power, low supply voltage requirements, and space-saving 8-lead SOIC package offerings make it an excellent choice for battery-powered data recorders.

Furthermore, the low bias currents and low current noise, coupled with the low voltage noise of the CLC1200, improve the dynamic range for better performance.

The value of capacitor C1 is chosen to maintain stability of the right leg drive loop. Proper safeguards, such as isolation, must be added to this circuit to protect the patient from possible harm.

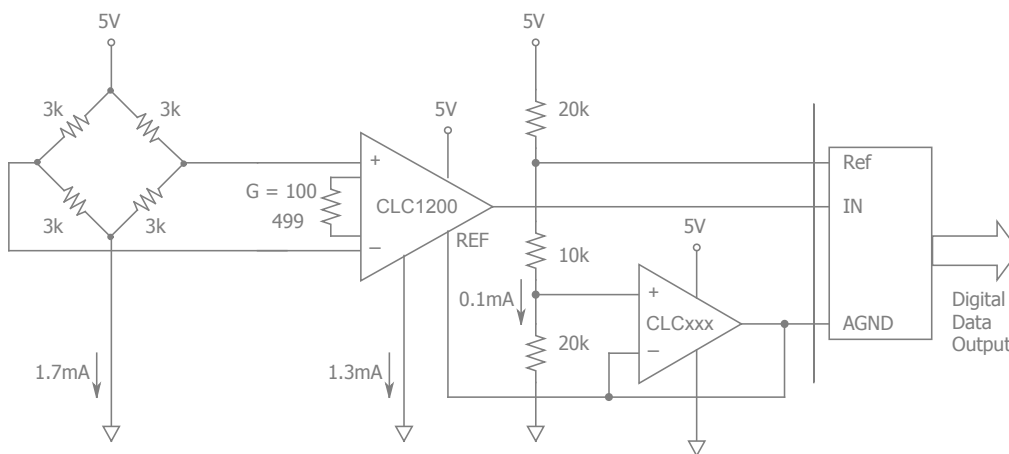

Figure 3: Pressure Monitoring Circuits Operating on a Single 5V Supply

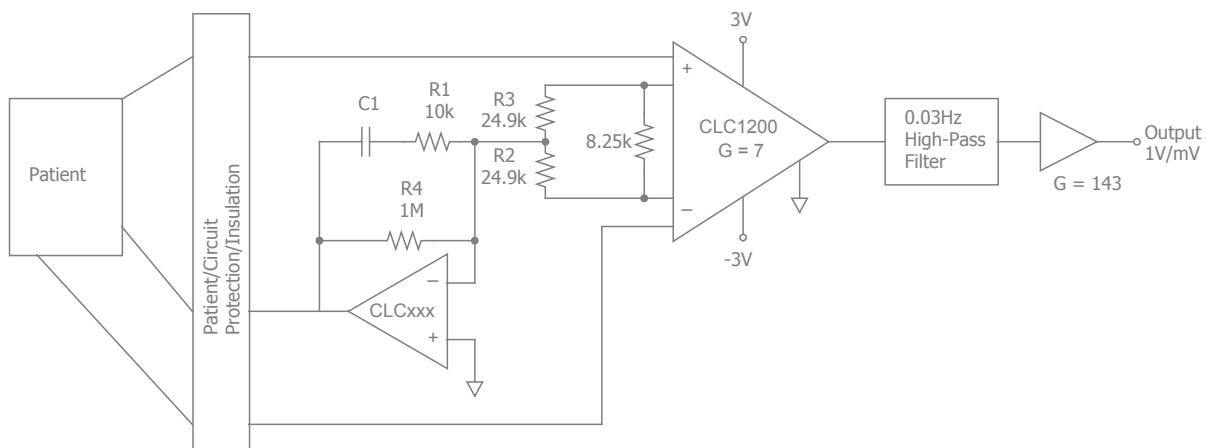

Figure 4: Typical Circuit for ECG Monitor Applications



Grounding

The output voltage of the CLC1200 is developed with respect to the potential on the reference terminal (pin 8). Simply tie the REF pin to the appropriate "local ground" to resolve many grounding problems.

To isolate low level analog signals from a noisy digital environment, many data-acquisition components have separate analog and digital ground pins. Use separate ground lines (analog and digital) to minimize current flow from sensitive areas to system ground. These ground returns must be tied together at some point, usually best at the ADC.

Layout Considerations

General layout and supply bypassing play major roles in high frequency performance. CADEKA has evaluation boards to use as a guide for high frequency layout and as an aid in device testing and characterization. Follow the steps below as a basis for high frequency layout:

- Include 6.8 μ F and 0.1 μ F ceramic capacitors for power supply decoupling
- Place the 6.8 μ F capacitor within 0.75 inches of the power pin
- Place the 0.1 μ F capacitor within 0.1 inches of the power pin
- Remove the ground plane under and around the part, especially near the input and output pins to reduce parasitic capacitance
- Minimize all trace lengths to reduce series inductances

Refer to the evaluation board layouts below for more information.

Evaluation Board Information

The following evaluation boards are available to aid in the testing and layout of these devices:

Evaluation Board	Products
CEB024	CLC1200 in SOIC-8

Evaluation Board Schematics

Evaluation board schematics and layouts are shown in Figures 5-7. These evaluation boards are built for dual-supply operation. Follow these steps to use the board in a single-supply application:

1. Short -Vs to ground.
2. Use C3 and C4, if the -Vs pin of the amplifier is not directly connected to the ground plane.

Figure 5. CEB00x Schematic

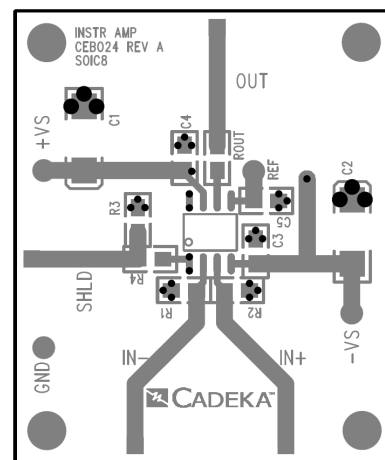

Figure 6. CEB024 Top View

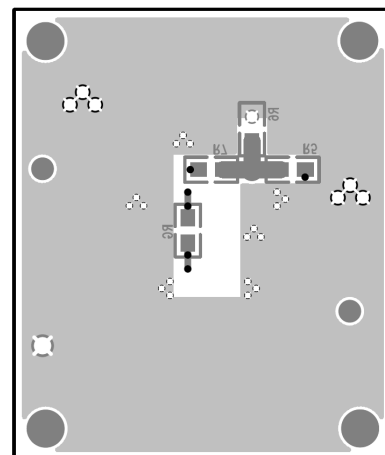

Figure 7. CEB024 Bottom View





Mechanical Dimensions

SOIC-8 Package

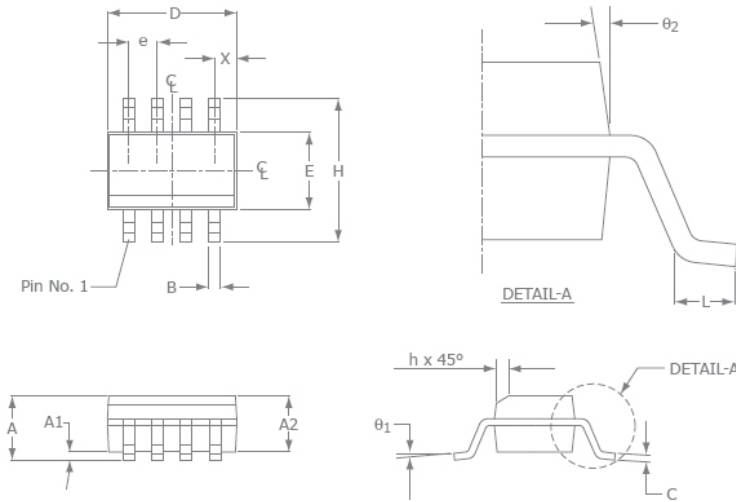

SOIC-8		
SYMBOL	MIN	MAX
A1	0.10	0.25
B	0.36	0.48
C	0.19	0.25
D	4.80	4.98
E	3.81	3.99
e	1.27 BSC	
H	5.80	6.20
h	0.25	0.5
L	0.41	1.27
A	1.37	1.73
θ_1	0°	8°
X	0.55 ref	
θ_2	7° BSC	

NOTE:

1. All dimensions are in millimeters.
2. Lead coplanarity should be 0 to 0.1mm (0.004") max.
3. Package surface finishing: VDI 24~27
4. All dimension excluding mold flashes.
5. The lead width, B to be determined at 0.1905mm from the lead tip.

For additional information regarding our products, please visit CADEKA at: cadeka.com

CADEKA Headquarters Loveland, Colorado
 T: 970.663.5452
 T: 877.663.5452 (toll free)

CADEKA, the CADEKA logo design, COMLINEAR, and the COMLINEAR logo design are trademarks or registered trademarks of CADEKA Microcircuits LLC. All other brand and product names may be trademarks of their respective companies.

CADEKA reserves the right to make changes to any products and services herein at any time without notice. CADEKA does not assume any responsibility or liability arising out of the application or use of any product or service described herein, except as expressly agreed to in writing by CADEKA; nor does the purchase, lease, or use of a product or service from CADEKA convey a license under any patent rights, copyrights, trademark rights, or any other of the intellectual property rights of CADEKA or of third parties.

Copyright ©2008, 2010-2011 by CADEKA Microcircuits LLC. All rights reserved.



Данный компонент на территории Российской Федерации

Вы можете приобрести в компании MosChip.

Для оперативного оформления запроса Вам необходимо перейти по данной ссылке:

<http://moschip.ru/get-element>

Вы можете разместить у нас заказ для любого Вашего проекта, будь то серийное производство или разработка единичного прибора.

В нашем ассортименте представлены ведущие мировые производители активных и пассивных электронных компонентов.

Нашей специализацией является поставка электронной компонентной базы двойного назначения, продукции таких производителей как XILINX, Intel (ex.ALTERA), Vicor, Microchip, Texas Instruments, Analog Devices, Mini-Circuits, Amphenol, Glenair.

Сотрудничество с глобальными дистрибьюторами электронных компонентов, предоставляет возможность заказывать и получать с международных складов практически любой перечень компонентов в оптимальные для Вас сроки.

На всех этапах разработки и производства наши партнеры могут получить квалифицированную поддержку опытных инженеров.

Система менеджмента качества компании отвечает требованиям в соответствии с ГОСТ Р ИСО 9001, ГОСТ РВ 0015-002 и ЭС РД 009

Офис по работе с юридическими лицами:

105318, г.Москва, ул.Щербаковская д.3, офис 1107, 1118, ДЦ «Щербаковский»

Телефон: +7 495 668-12-70 (многоканальный)

Факс: +7 495 668-12-70 (доб.304)

E-mail: info@moschip.ru

Skype отдела продаж:

moschip.ru

moschip.ru_4

moschip.ru_6

moschip.ru_9