

FEATURES

- Low noise: 1.1 nV/ $\sqrt{\text{Hz}}$ at 1 kHz
- Low distortion: -120 dB THD @ 1 kHz
- Input noise, 0.1 Hz to 10 Hz: <76 nV p-p
- Slew rate: 14 V/ μs
- Wide bandwidth: 10 MHz
- Supply current: 4.8 mA/amp typical
- Low offset voltage: 10 μV typical
- CMRR: 120 dB
- Unity-gain stable
- ± 15 V operation

APPLICATIONS

- Professional audio preamplifiers
- ATE/precision testers
- Imaging systems
- Medical/physiological measurements
- Precision detectors/instruments
- Precision data conversion

GENERAL DESCRIPTION

The AD8597/AD8599 are very low noise, low distortion operational amplifiers ideal for use as preamplifiers. The low noise of 1.1 nV/ $\sqrt{\text{Hz}}$ and low harmonic distortion of -120 dB (or better) at audio bandwidths give the AD8597/AD8599 the wide dynamic range necessary for preamplifiers in audio, medical, and instrumentation applications. The excellent slew rate of 14 V/ μs and 10 MHz gain bandwidth make them highly suitable for medical applications. The low distortion and fast settling time make them ideal for buffering of high resolution data converters.

PIN CONFIGURATIONS

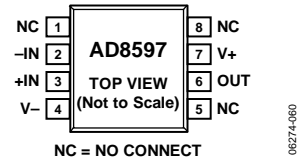

Figure 1. AD8597 8-Lead SOIC (R-8)

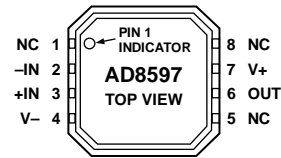

Figure 2. AD8597 8-Lead LFCSP (CP-8-2)

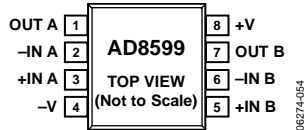

Figure 3. AD8599 8-Lead SOIC (R-8)

The AD8597 is available in 8-lead SOIC and LFCSP packages, while the AD8599 is available in an 8-lead SOIC package. They are both specified over a -40°C to $+125^{\circ}\text{C}$ temperature range. The AD8597 and AD8599 are members of a growing series of low noise op amps offered by Analog Devices, Inc., (see Table 1).

Table 1. Low Noise Op Amps

Package	0.9 nV	1.1 nV	1.8 nV	2.8 nV	3.8 nV
Single	AD797	AD8597	ADA4004-1	AD8675	AD8671
Dual		AD8599	ADA4004-2	AD8676	AD8672
Quad			ADA4004-4		AD8674

TABLE OF CONTENTS

Features	1	ESD Caution.....	5
Applications.....	1	Typical Performance Characteristics	6
Pin Configurations	1	Functional Operation.....	15
General Description	1	Input Voltage Range.....	15
Revision History	2	Output Phase Reversal.....	15
Specifications.....	3	Noise and Source Impedance Considerations	15
Absolute Maximum Ratings.....	5	Outline Dimensions	17
Thermal Resistance	5	Ordering Guide	17
Power Sequencing	5		

REVISION HISTORY

2/13—Rev. C to Rev. D

Changes to Figure 44	12
Changes to Figure 46 and Figure 49.....	13

12/09—Rev. B to Rev. C

Changes to Table 1	1
--------------------------	---

10/08—Rev. A to Rev. B

Added AD8597	Universal
Added LFCSP_VD	Universal
Added Table 1.....	1
Changes to Specifications Section	3
Changes to Absolute Maximum Ratings Section	5
Changes to Typical Performance Characteristics Section.....	6
Added Figure 12 and Figure 15.....	7
Added Figure 18 and Figure 19.....	8
Added Figure 30 and Figure 33.....	10

Added Figure 34 to Figure 38	11
Added Figure 42 and Figure 45	12
Added Figure 52, Figure 55, Figure 57	14
Added Functional Operation Section.....	15
Added Figure 58	15
Updated Outline Dimensions	17
Changes to Ordering Guide	17

4/07—Rev. 0 to Rev. A

Updated Layout	5
Changes to Figure 45 Caption	12
Added Figure 48	12
Changes to Figure 51 Caption	13

2/07—Revision 0: Initial Version

SPECIFICATIONS

$V_{SY} = \pm 5\text{ V}$, $V_{CM} = 0\text{ V}$, $V_O = 0\text{ V}$, $T_A = 25^\circ\text{C}$, unless otherwise specified.

Table 2.

Parameter	Symbol	Conditions	Min	Typ	Max	Unit
INPUT CHARACTERISTICS						
Offset Voltage	V_{OS}	$-40^\circ\text{C} \leq T_A \leq +125^\circ\text{C}$		15	120	μV
					180	μV
Offset Voltage Drift	$\Delta V_{OS}/\Delta T$	$-40^\circ\text{C} \leq T_A \leq +125^\circ\text{C}$		0.8	2.2	$\mu\text{V}/^\circ\text{C}$
Input Bias Current	I_B	$-40^\circ\text{C} \leq T_A \leq +125^\circ\text{C}$		40	210	nA
					340	nA
Input Offset Current	I_{OS}	$-40^\circ\text{C} \leq T_A \leq +125^\circ\text{C}$		65	250	nA
					340	nA
Input Voltage Range	IVR		-2.0		+2.0	V
Common-Mode Rejection Ratio	CMRR	$-2.0\text{ V} \leq V_{CM} \leq +2.0\text{ V}$ $-40^\circ\text{C} \leq T_A \leq +125^\circ\text{C}$	120	135		dB
			105			dB
Large Signal Voltage Gain	A_{VO}	$R_L \geq 600\ \Omega$, $V_O = -11\text{ V to } +11\text{ V}$ $-40^\circ\text{C} \leq T_A \leq +125^\circ\text{C}$	105	110		dB
			100			dB
Input Capacitance						
Differential Capacitance	C_{DIFF}			15.4		pF
Common-Mode Capacitance	C_{CM}			5.5		pF
OUTPUT CHARACTERISTICS						
Output Voltage High	V_{OH}	$R_L = 600\ \Omega$ $-40^\circ\text{C} \leq T_A \leq +125^\circ\text{C}$	3.5	3.7		V
			3.3			V
		$R_L = 2\ \text{k}\Omega$ $-40^\circ\text{C} \leq T_A \leq +125^\circ\text{C}$	3.7	3.8		V
			3.5			V
Output Voltage Low	V_{OL}	$R_L = 600\ \Omega$ $-40^\circ\text{C} \leq T_A \leq +125^\circ\text{C}$		-3.6	-3.4	V
					-3.3	V
		$R_L = 2\ \text{k}\Omega$ $-40^\circ\text{C} \leq T_A \leq +125^\circ\text{C}$		-3.7	-3.5	V
					-3.4	V
Output Short-Circuit Current	I_{SC}			± 52		mA
Closed-Loop Output Impedance	Z_{OUT}	At 1 MHz, $A_V = 1$		5		Ω
POWER SUPPLY						
Power Supply Rejection Ratio	PSRR	$V_{SY} = \pm 18\text{ V to } \pm 4.5\text{ V}$ $-40^\circ\text{C} \leq T_A \leq +125^\circ\text{C}$	120	140		dB
			118			dB
Supply Current per Amplifier	I_{SY}	$-40^\circ\text{C} \leq T_A \leq +125^\circ\text{C}$		4.8	5.5	mA
					6.5	mA
DYNAMIC PERFORMANCE						
Slew Rate	SR	$A_V = -1$, $R_L = 2\ \text{k}\Omega$ $A_V = 1$, $R_L = 2\ \text{k}\Omega$		14		V/ μs
				14		V/ μs
Settling Time	t_S	To 0.01%, step = 10 V		2		μs
Gain Bandwidth Product	GBP			10		MHz
Phase Margin	Φ_M			60		Degrees
NOISE PERFORMANCE						
Peak-to-Peak Noise	e_n p-p	0.1 Hz to 10 Hz		76		nV p-p
Voltage Noise Density	e_n	$f = 1\ \text{kHz}$		1.07	1.15	nV/ $\sqrt{\text{Hz}}$
		$f = 10\ \text{Hz}$			1.5	nV/ $\sqrt{\text{Hz}}$
Correlated Current Noise		$f = 1\ \text{kHz}$		2.0		pA/ $\sqrt{\text{Hz}}$
		$f = 10\ \text{Hz}$		4.2		pA/ $\sqrt{\text{Hz}}$
Uncorrelated Current Noise		$f = 1\ \text{kHz}$		2.4		pA/ $\sqrt{\text{Hz}}$
		$f = 10\ \text{Hz}$		5.2		pA/ $\sqrt{\text{Hz}}$
Total Harmonic Distortion + Noise	THD + N	$G = 1$, $R_L \geq 1\ \text{k}\Omega$, $f = 1\ \text{kHz}$, $V_{RMS} = 1\text{ V}$		-120		dB
Channel Separation	CS	$f = 10\ \text{kHz}$		-120		dB

$V_S = \pm 15\text{ V}$, $V_{CM} = 0\text{ V}$, $V_O = 0\text{ V}$, $T_A = +25^\circ\text{C}$, unless otherwise specified.

Table 3.

Parameter	Symbol	Conditions	Min	Typ	Max	Unit
INPUT CHARACTERISTICS						
Offset Voltage	V_{OS}	$-40^\circ\text{C} \leq T_A \leq +125^\circ\text{C}$		10	120	μV
					180	μV
Offset Voltage Drift	$\Delta V_{OS}/\Delta T$	$-40^\circ\text{C} \leq T_A \leq +125^\circ\text{C}$		0.8	2.2	$\mu\text{V}/^\circ\text{C}$
Input Bias Current	I_B	$-40^\circ\text{C} \leq T_A \leq +125^\circ\text{C}$		25	200	nA
					300	nA
Input Offset Current	I_{OS}	$-40^\circ\text{C} \leq T_A \leq +125^\circ\text{C}$		50	200	nA
					300	nA
Input Voltage Range	IVR		-12.5		+12.5	V
Common-Mode Rejection Ratio	CMRR	$-12.5\text{ V} \leq V_{CM} \leq +12.5\text{ V}$ $-40^\circ\text{C} \leq T_A \leq +125^\circ\text{C}$		120	135	dB
				115		dB
Large Signal Voltage Gain	A_{VO}	$R_L \geq 600\ \Omega$, $V_O = -11\text{ V to } +11\text{ V}$ $-40^\circ\text{C} \leq T_A \leq +125^\circ\text{C}$		110	116	dB
				106		dB
Input Capacitance						
Differential Capacitance	C_{DIFF}			12.1		pF
Common-Mode Capacitance	C_{CM}			5.1		pF
OUTPUT CHARACTERISTICS						
Output Voltage High	V_{OH}	$R_L = 600\ \Omega$ $-40^\circ\text{C} \leq T_A \leq +125^\circ\text{C}$	13.1	13.4		V
			12.8			V
			13.5	13.7		V
			13.2			V
Output Voltage Low	V_{OL}	$R_L = 600\ \Omega$ $-40^\circ\text{C} \leq T_A \leq +125^\circ\text{C}$		-13.2	-12.9	V
					-12.8	V
				-13.5	-13.4	V
					-13.3	V
Output Short-Circuit Current	I_{SC}			± 52		mA
Closed-Loop Output Impedance	Z_{OUT}	At 1 MHz, $A_V = 1$		5		Ω
POWER SUPPLY						
Power Supply Rejection Ratio	PSRR	$V_{SY} = \pm 18\text{ V to } \pm 4.5\text{ V}$ $-40^\circ\text{C} \leq T_A \leq +125^\circ\text{C}$	120	140		dB
			118			dB
Supply Current per Amplifier	I_{SY}	$-40^\circ\text{C} \leq T_A \leq +125^\circ\text{C}$		5.0	5.7	mA
					6.75	mA
DYNAMIC PERFORMANCE						
Slew Rate	SR	$A_V = -1$, $R_L = 2\text{ k}\Omega$ $A_V = 1$, $R_L = 2\text{ k}\Omega$		16		V/ μs
					15	V/ μs
Settling Time	t_s	To 0.01%, step = 10 V		2		μs
Gain Bandwidth Product	GBP			10		MHz
Phase Margin	Φ_M			65		Degrees
NOISE PERFORMANCE						
Peak-to-Peak Noise	e_n p-p	0.1 Hz to 10 Hz		76		nV p-p
Voltage Noise Density	e_n	$f = 1\text{ kHz}$ $f = 10\text{ Hz}$		1.07	1.15	nV/ $\sqrt{\text{Hz}}$
					1.5	nV/ $\sqrt{\text{Hz}}$
Correlated Current Noise		$f = 1\text{ kHz}$ $f = 10\text{ Hz}$		1.9		pA/ $\sqrt{\text{Hz}}$
				4.3		pA/ $\sqrt{\text{Hz}}$
Uncorrelated Current Noise		$f = 1\text{ kHz}$ $f = 10\text{ Hz}$		2.3		pA/ $\sqrt{\text{Hz}}$
				5.3		pA/ $\sqrt{\text{Hz}}$
Total Harmonic Distortion + Noise	THD + N	$G = 1$, $R_L \geq 1\text{ k}\Omega$, $f = 1\text{ kHz}$, $V_{RMS} = 3\text{ V}$		-120		dB
Channel Separation	CS	$f = 10\text{ kHz}$		-120		dB

ABSOLUTE MAXIMUM RATINGS

Table 4.

Parameter	Rating
Supply Voltage	$\pm 18\text{ V}$
Input Voltage	$-V \leq V_{IN} \leq +V$
Differential Input Voltage ¹	$\pm 1\text{ V}$
Output Short-Circuit to GND	Indefinite
Storage Temperature Range	-65°C to $+150^{\circ}\text{C}$
Operating Temperature Range	-40°C to $+125^{\circ}\text{C}$
Lead Temperature Range (Soldering 60 sec)	300°C
Junction Temperature	150°C

¹ If the differential input voltage exceeds 1 V, the current should be limited to 5 mA.

Stresses above those listed under Absolute Maximum Ratings may cause permanent damage to the device. This is a stress rating only; functional operation of the device at these or any other conditions above those indicated in the operational section of this specification is not implied. Exposure to absolute maximum rating conditions for extended periods may affect device reliability.

THERMAL RESISTANCE

θ_{JA} is specified with the device soldered on a circuit board with its exposed paddle soldered to a pad (if applicable) on a 4-layer JEDEC standard PCB with zero air flow.

Table 5.

Package Type	θ_{JA}	θ_{JC}	Unit
8-Lead LFCSP_VD (CP-8-2)	78	20	$^{\circ}\text{C}/\text{W}$
8-Lead SOIC (R-8) (AD8597)	140	39	$^{\circ}\text{C}/\text{W}$
8-Lead SOIC (R-8) (AD8599)	120	36	$^{\circ}\text{C}/\text{W}$

POWER SEQUENCING

The op amp supplies should be applied simultaneously. The op amp supplies should be stable before any input signals are applied. In any case, the input current must be limited to 5 mA.

ESD CAUTION



ESD (electrostatic discharge) sensitive device. Charged devices and circuit boards can discharge without detection. Although this product features patented or proprietary protection circuitry, damage may occur on devices subjected to high energy ESD. Therefore, proper ESD precautions should be taken to avoid performance degradation or loss of functionality.

TYPICAL PERFORMANCE CHARACTERISTICS

T_A = 25°C, unless otherwise noted.

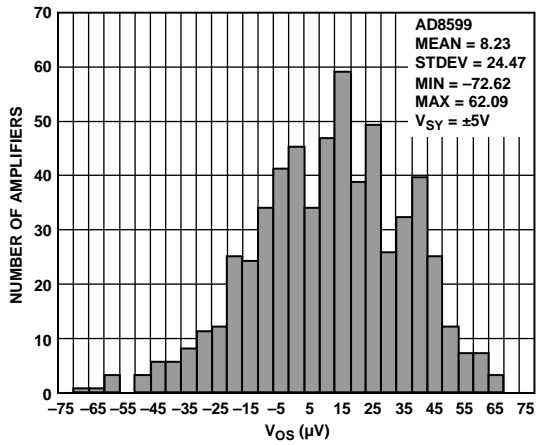

Figure 4. Input Offset Voltage Distribution

06274-001

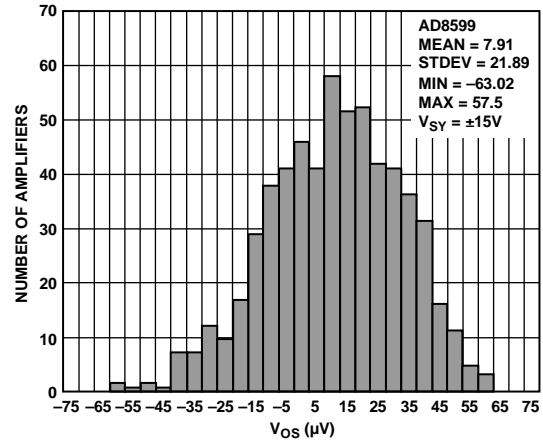

Figure 7. Input Offset Voltage Distribution

06274-002

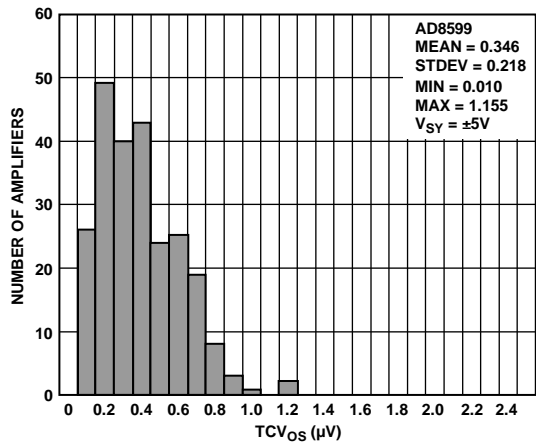

Figure 5. TCV_{os} Distribution, -40°C ≤ T_A ≤ +125°C

06274-004

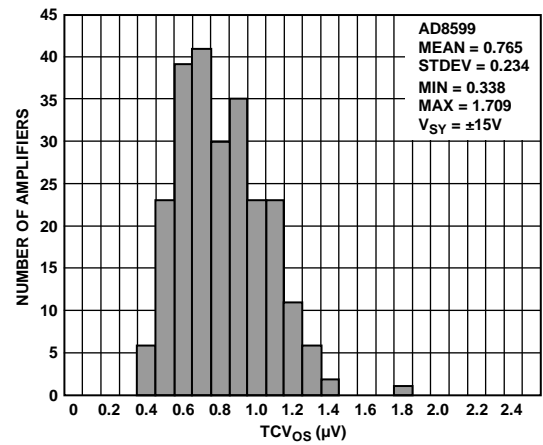

Figure 8. TCV_{os} Distribution, -40°C ≤ T_A ≤ +125°C

06274-007

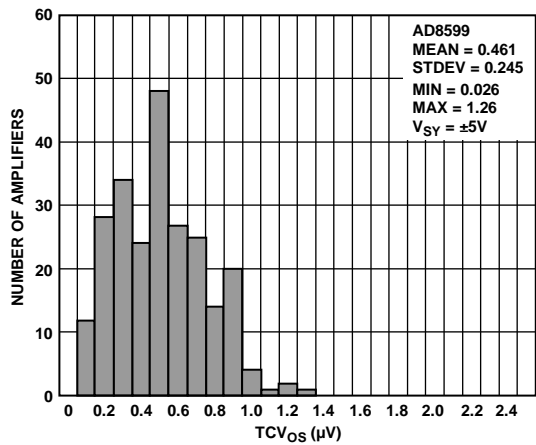

Figure 6. TCV_{os} Distribution, -40°C ≤ T_A ≤ +85°C

06274-006

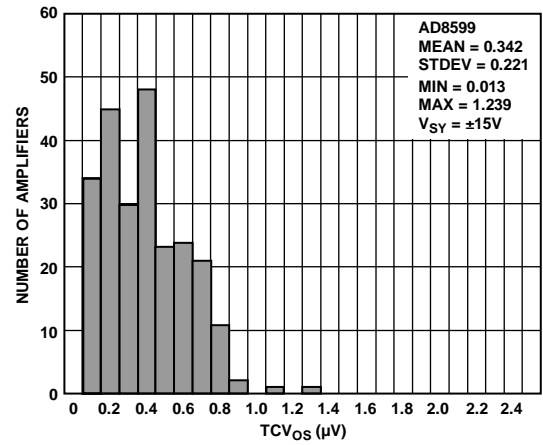

Figure 9. TCV_{os} Distribution, -40°C ≤ T_A ≤ +85°C

06274-005

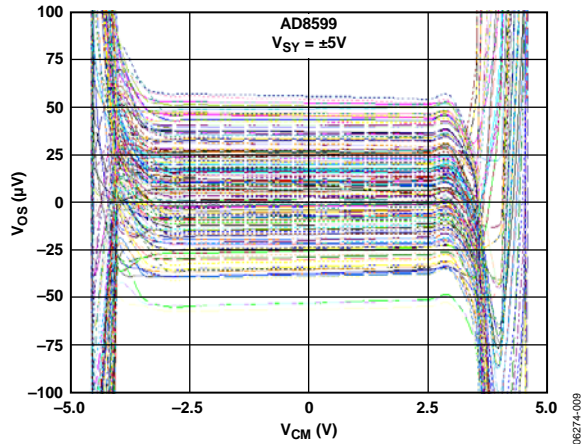

Figure 10. Offset Voltage vs. V_{CM}

06274-009

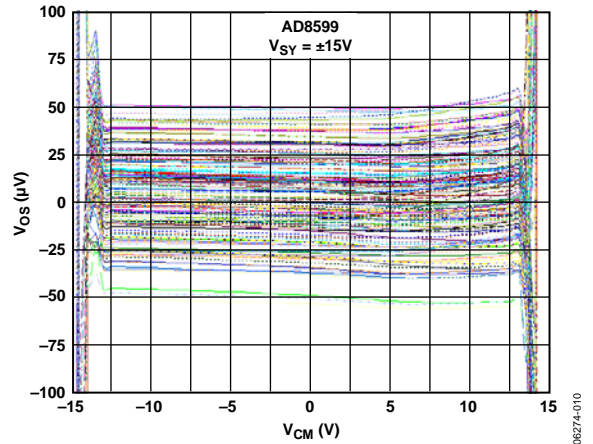

Figure 13. Offset Voltage vs. V_{CM}

06274-010

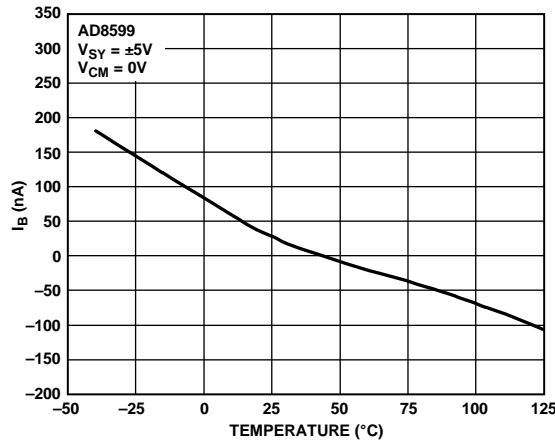

Figure 11. Input Bias Current vs. Temperature

06274-011

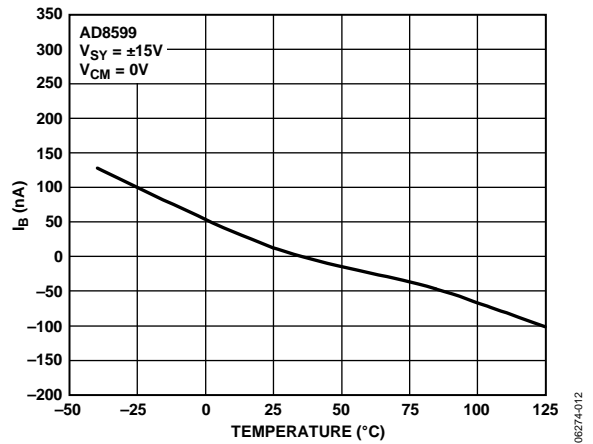

Figure 14. Input Bias Current vs. Temperature

06274-012

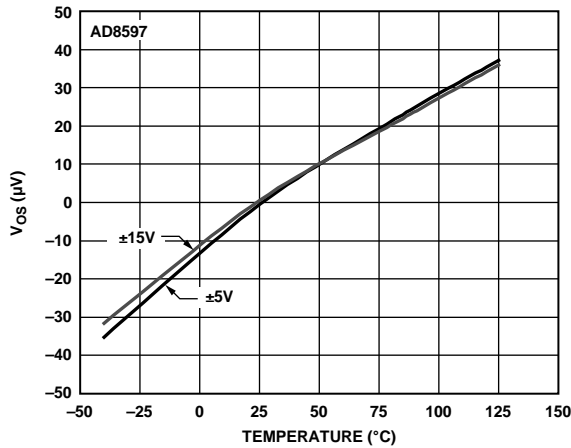

Figure 12. Input Offset Voltage vs. Temperature

06274-062

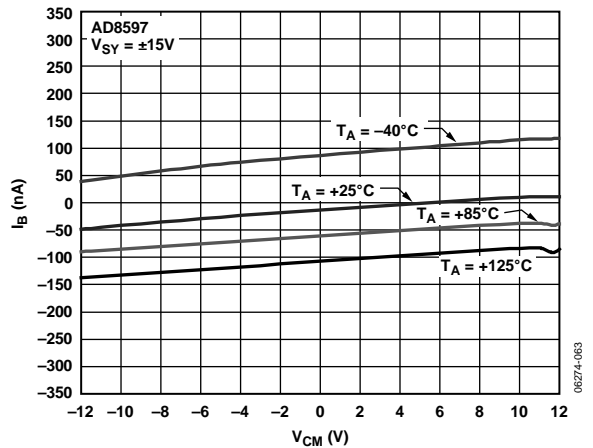

Figure 15. Input Bias Current vs. Temperature

06274-063

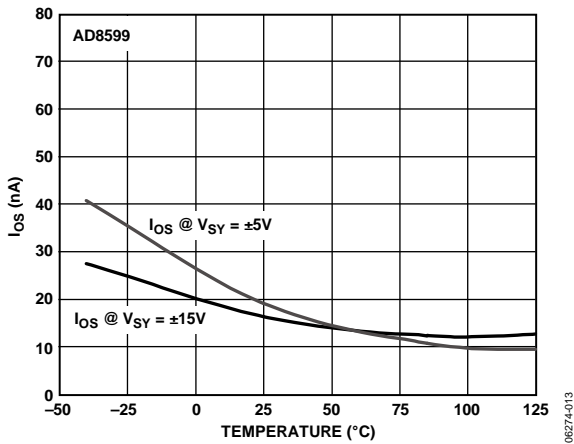

Figure 16. Input Offset Current vs. Temperature

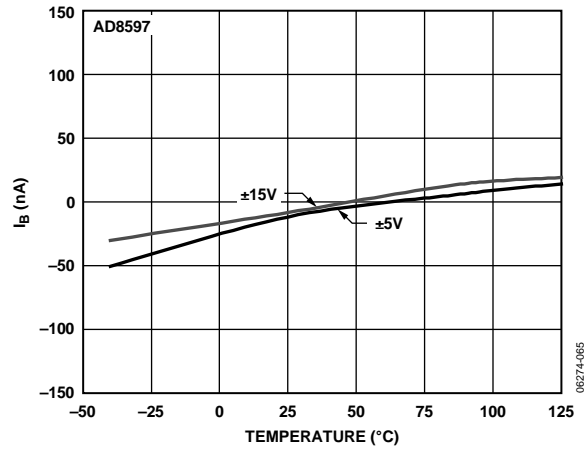

Figure 19. Input Offset Current vs. Temperature

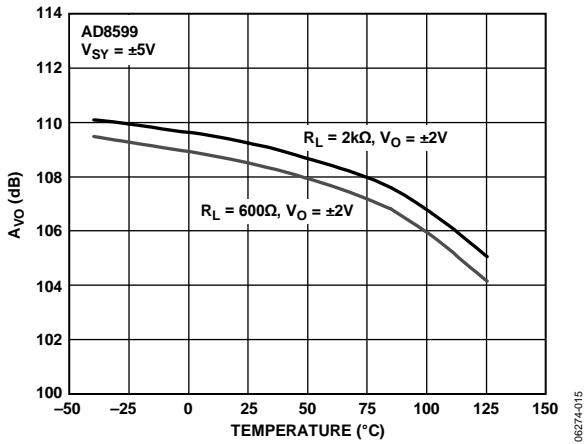

Figure 17. Large Signal Voltage Gain vs. Temperature

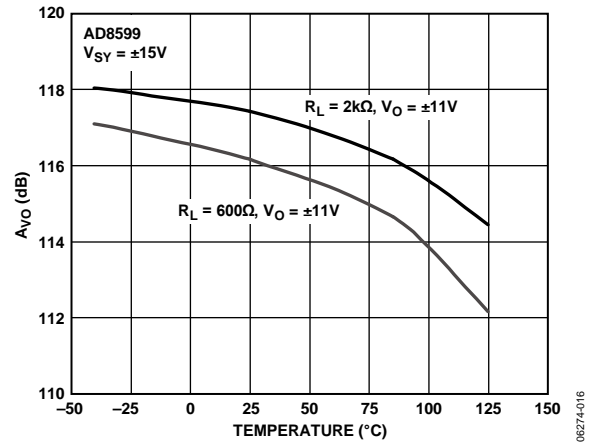

Figure 20. Large Signal Voltage Gain vs. Temperature

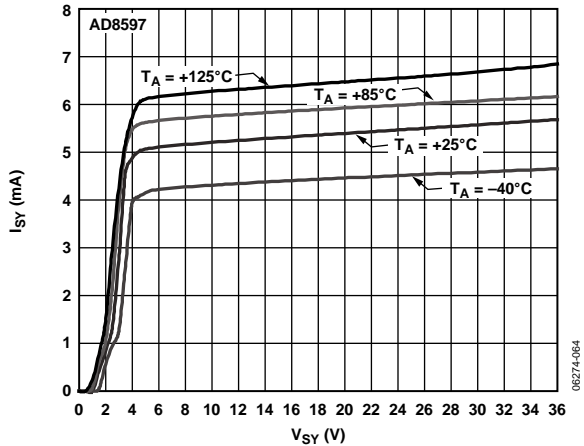

Figure 18. Supply Current vs. Supply Voltage

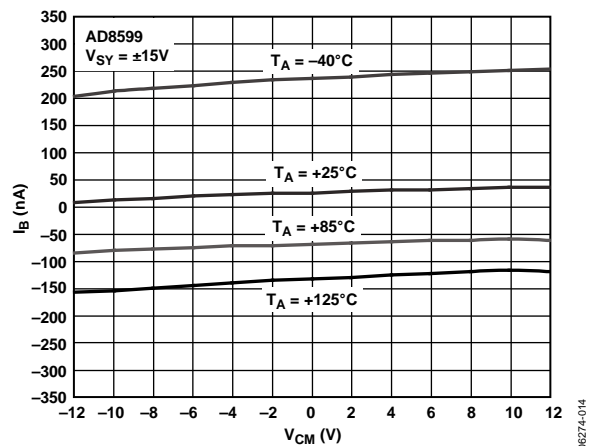

Figure 21. Input Bias Current vs. V_{CM}

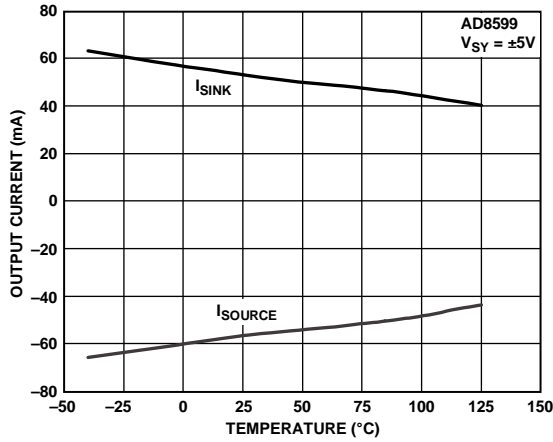

Figure 22. I_{sc} vs. Temperature

06274-017

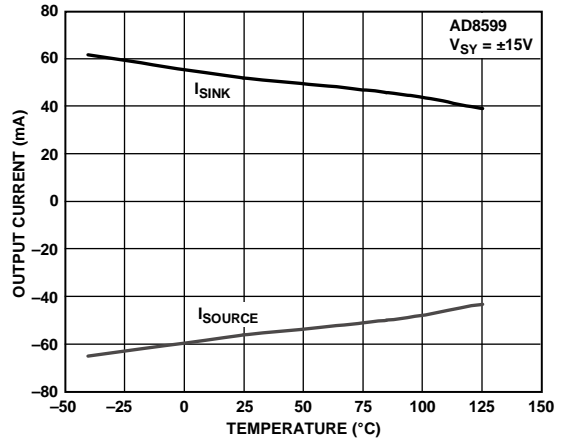

Figure 25. I_{sc} vs. Temperature

06274-018

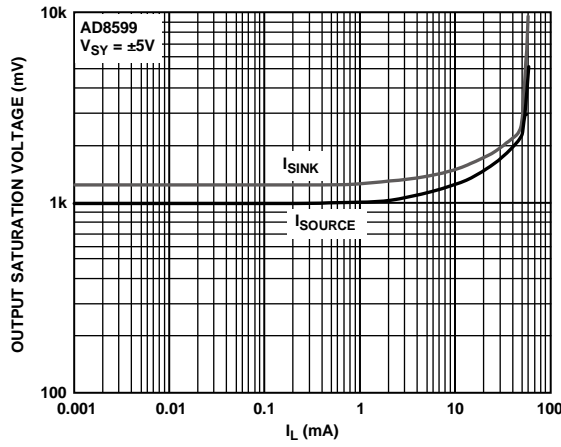

Figure 23. Output Saturation Voltage vs. Current Load

06274-021

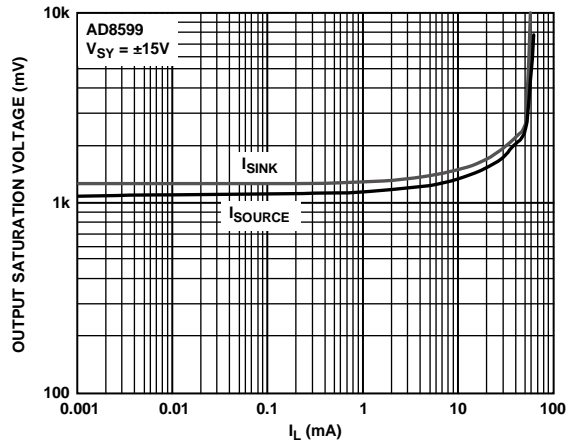

Figure 26. Output Saturation Voltage vs. Current Load

06274-022

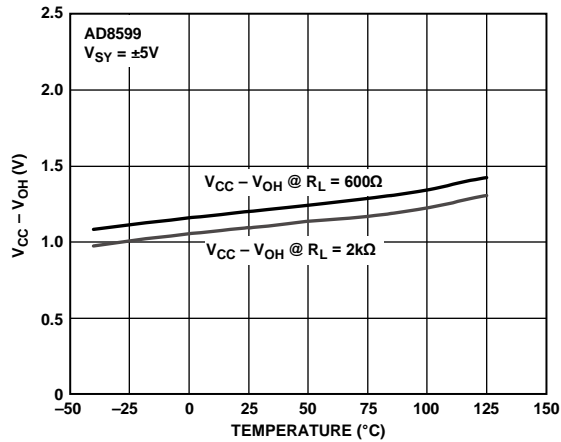

Figure 24. Output Saturation Voltage vs. Temperature

06274-027

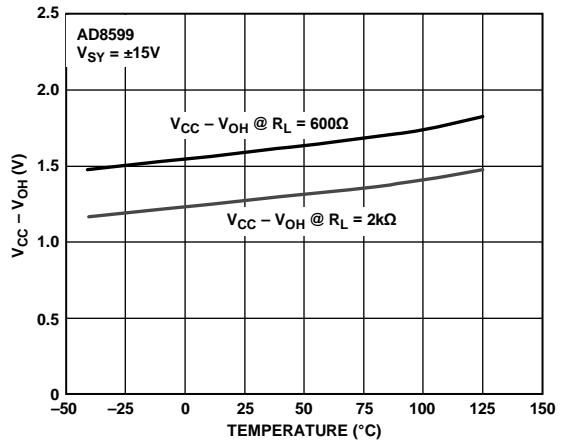

Figure 27. Output Saturation Voltage vs. Temperature

06274-029

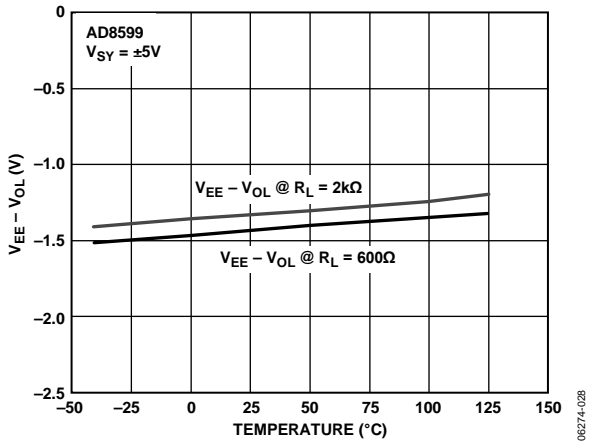

Figure 28. Output Saturation Voltage vs. Temperature

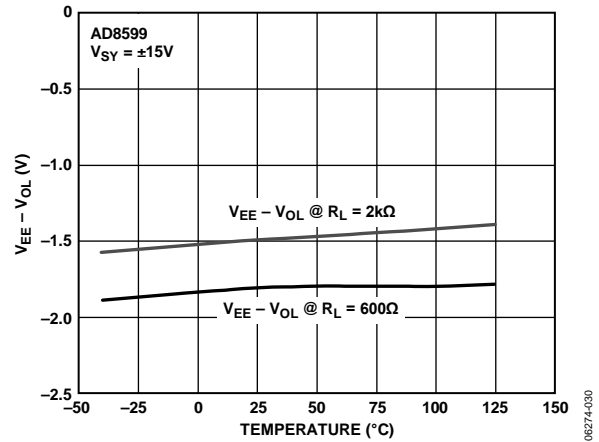

Figure 31. Output Saturation Voltage vs. Temperature

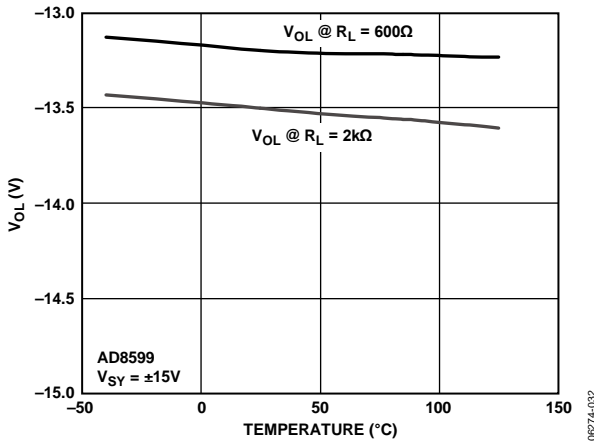

Figure 29. Output Voltage Low vs. Temperature

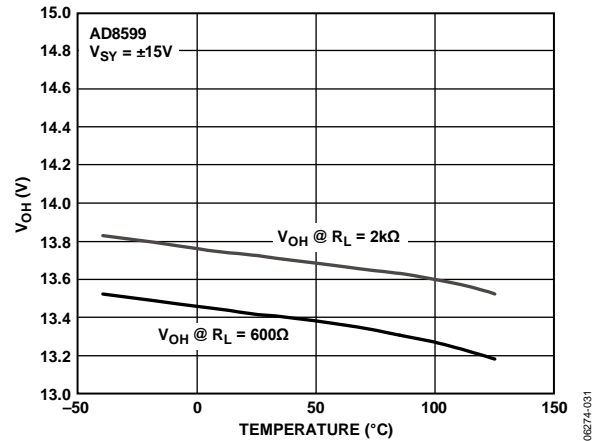

Figure 32. Output Voltage High vs. Temperature

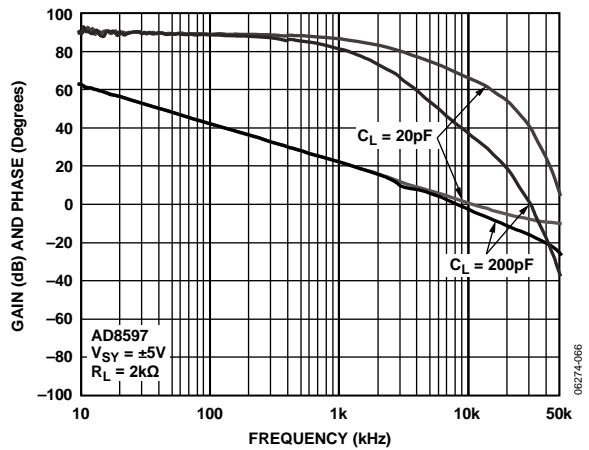

Figure 30. Gain and Phase vs. Frequency

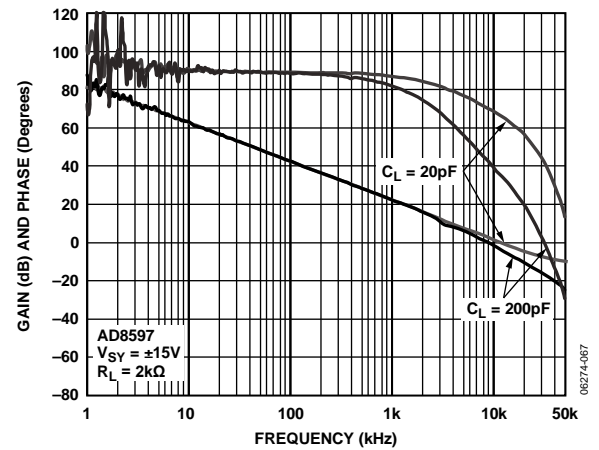

Figure 33. Gain and Phase vs. Frequency

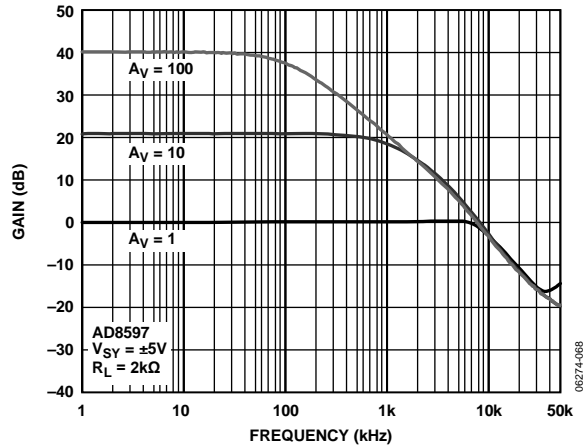

Figure 34. Closed-Loop Gain vs. Frequency

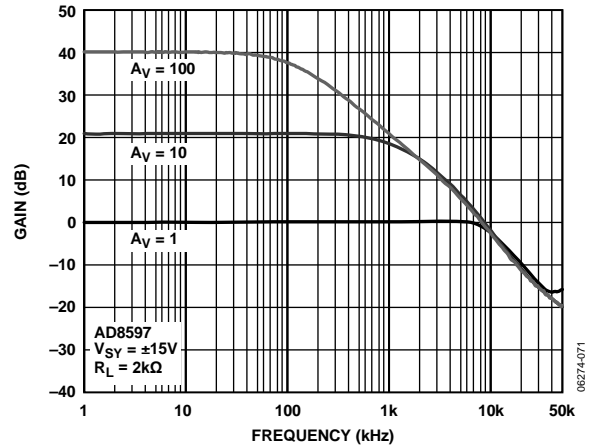

Figure 37. Closed-Loop Gain vs. Frequency

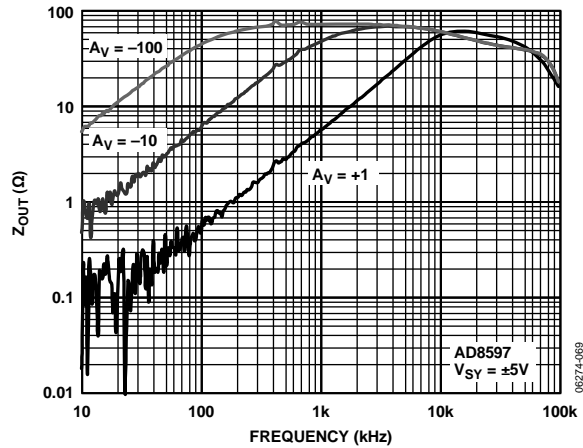

Figure 35. Closed-Loop Output Impedance vs. Frequency

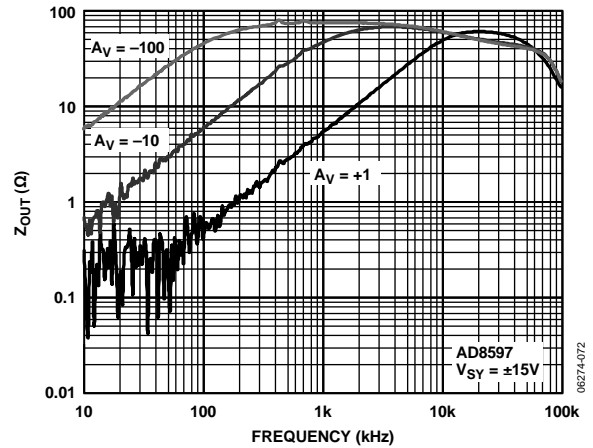

Figure 38. Closed-Loop Output Impedance vs. Frequency

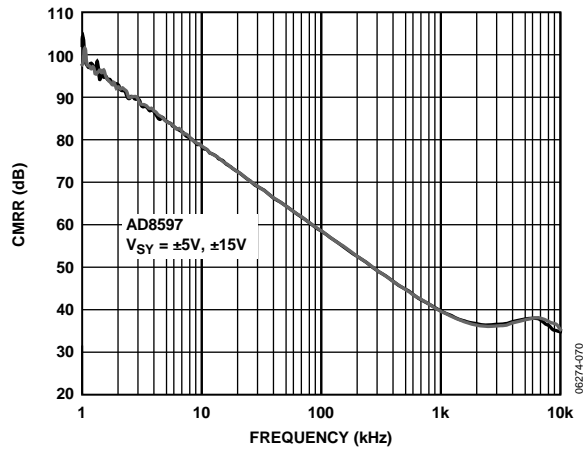

Figure 36. Common-Mode Rejection Ratio vs. Frequency

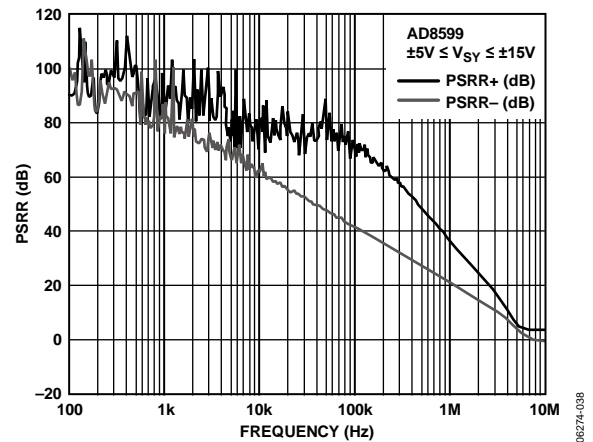

Figure 39. Power Supply Rejection Ratio vs. Frequency

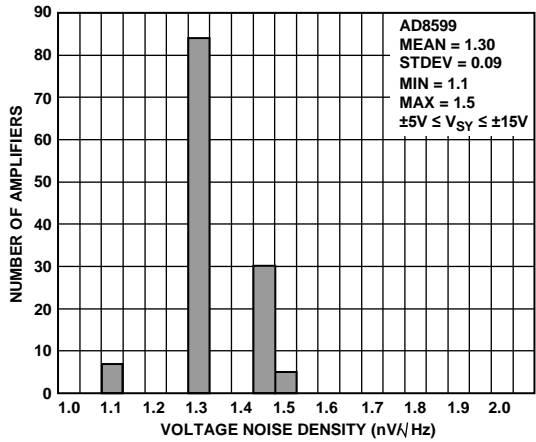

Figure 40. Voltage Noise Density @ 10 Hz

06274-039

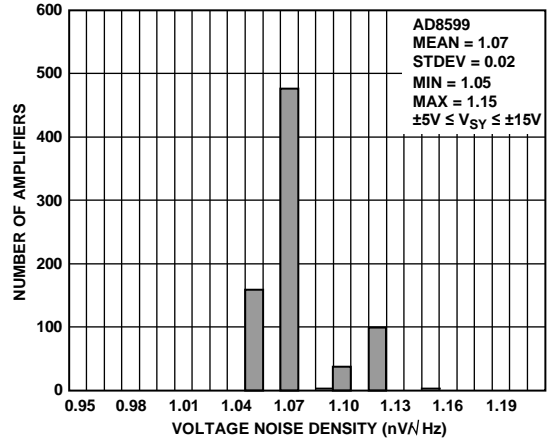

Figure 43. Voltage Noise Density @ 1 kHz

06274-040

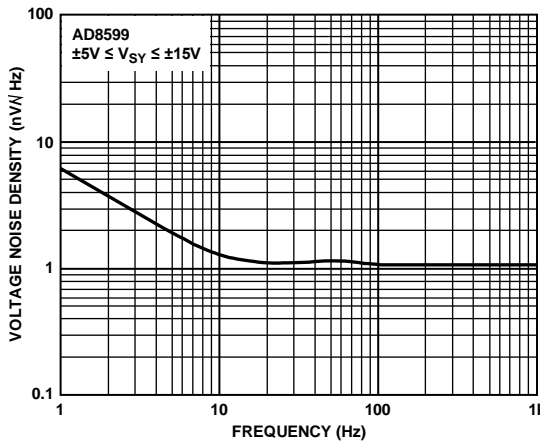

Figure 41. Voltage Noise Density vs. Frequency

06274-041

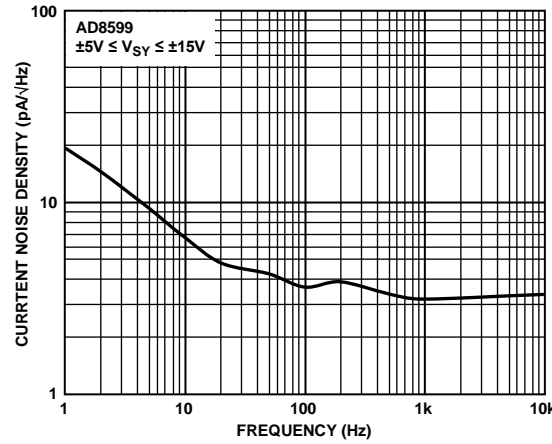

Figure 44. Current Noise Density vs. Frequency

06274-042

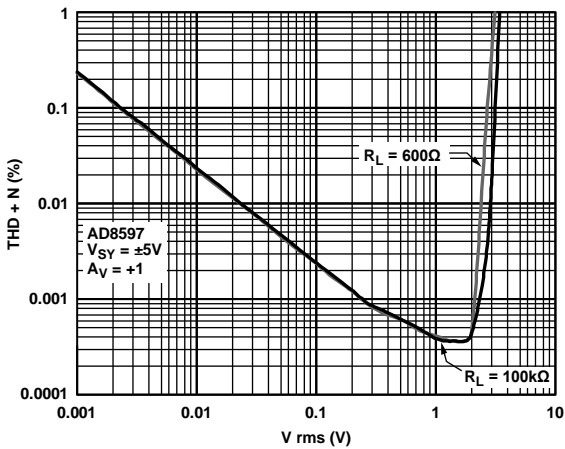

Figure 42. THD + N vs. Amplitude

06274-073

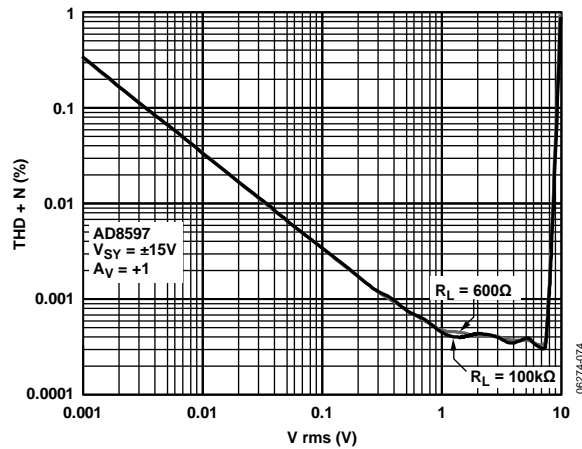

Figure 45. THD + N vs. Amplitude

06274-074

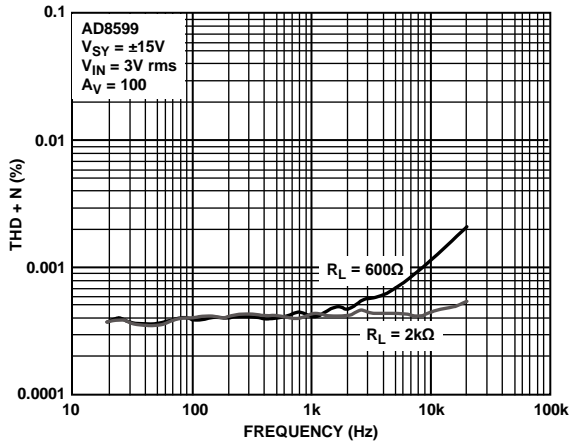

Figure 46. THD + N vs. Frequency

06274-043

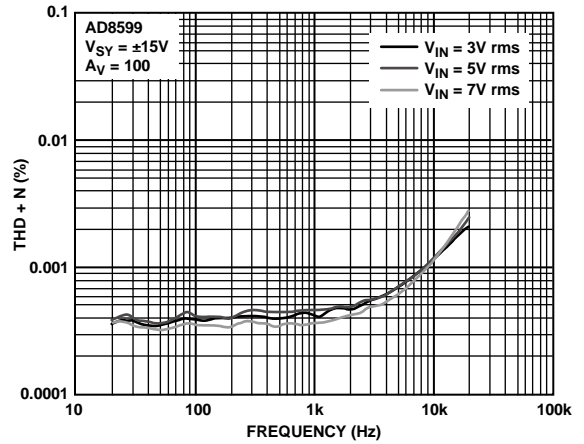

Figure 49. THD + N vs. Frequency

06274-044

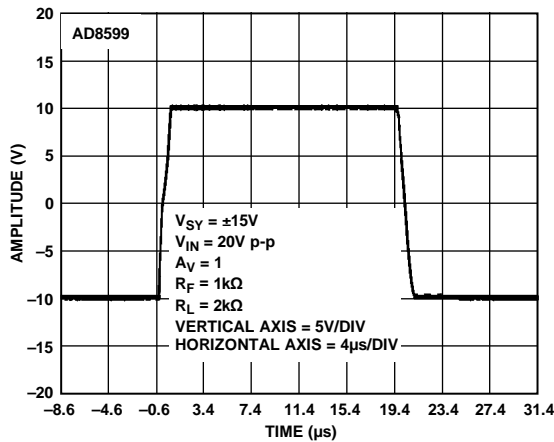

Figure 47. Large Signal Response

06274-047

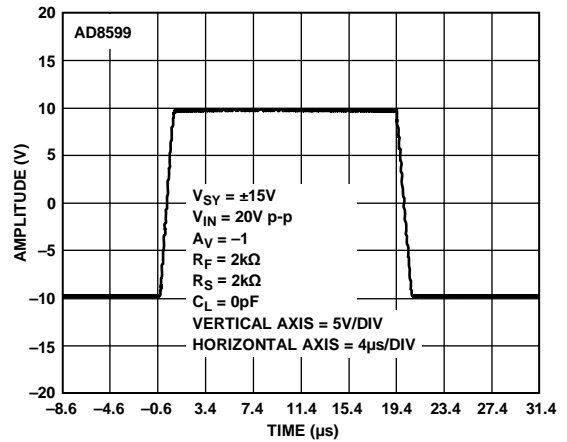

Figure 50. Large Signal Response

06274-048

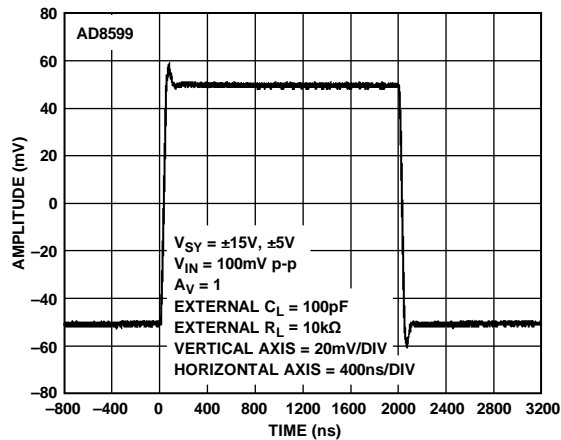

Figure 48. Small Signal Response

06274-046

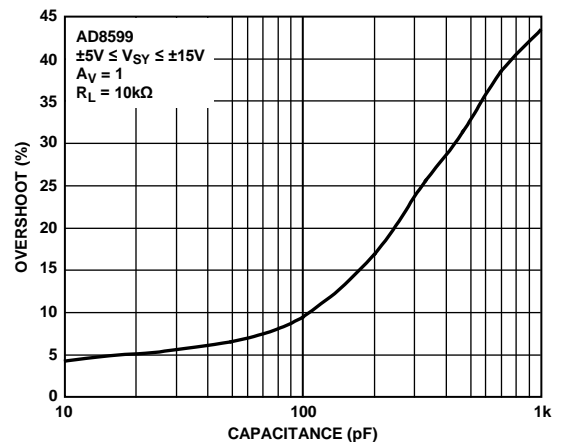

Figure 51. Overshoot vs. Capacitance

06274-049

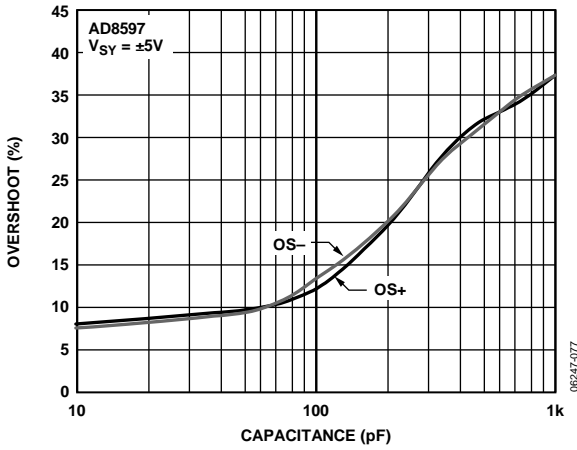

Figure 52. Overshoot vs. Capacitive Load

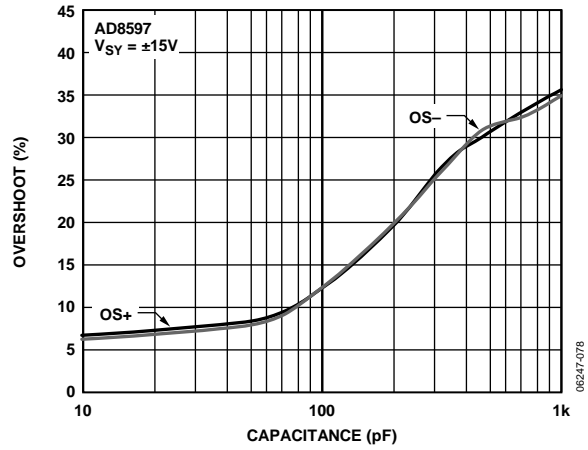

Figure 55. Overshoot vs. Capacitive Load

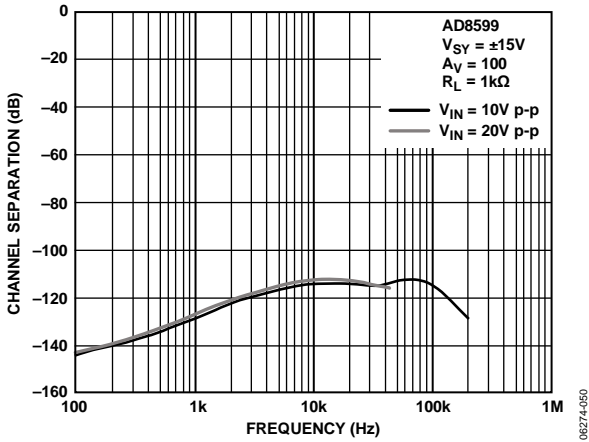

Figure 53. Channel Separation vs. Frequency

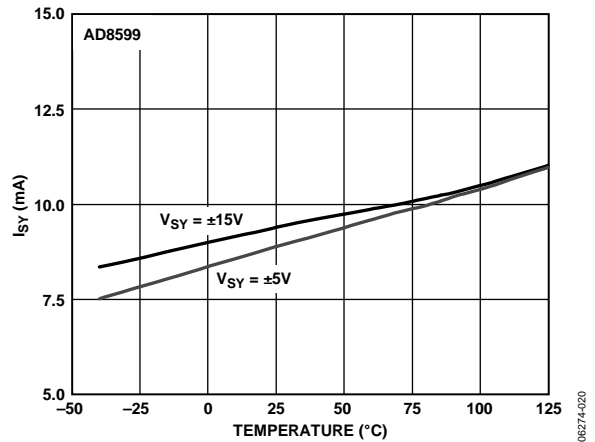

Figure 56. Supply Current vs. Temperature

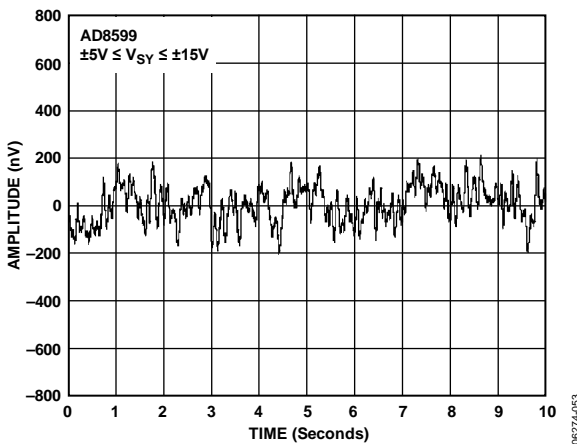

Figure 54. Peak-to-Peak Noise

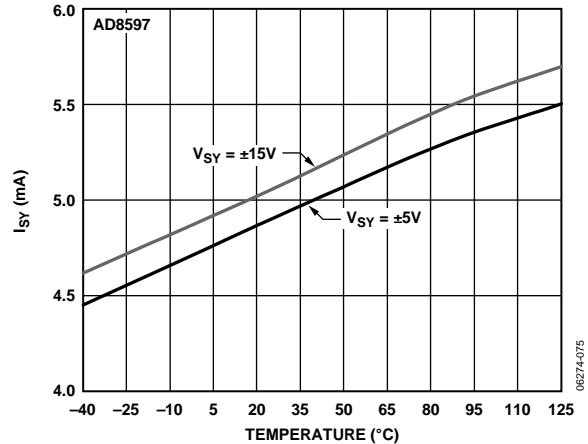

Figure 57. Supply Current vs. Temperature

FUNCTIONAL OPERATION

INPUT VOLTAGE RANGE

The AD8597/AD8599 are not rail-to-rail input amplifiers; therefore, care is required to ensure that both inputs do not exceed the input voltage range. Under normal negative feedback operating conditions, the amplifier corrects its output to ensure that the two inputs are at the same voltage. However, if either input exceeds the input voltage range, the loop opens and large currents begin to flow through the ESD protection diodes in the amplifier.

These diodes are connected between the inputs and each supply rail to protect the input transistors against an electrostatic discharge event and they are normally reverse-biased. However, if the input voltage exceeds the supply voltage, these ESD diodes can become forward-biased. Without current limiting, excessive amounts of current may flow through these diodes, causing permanent damage to the device. If inputs are subject to over-voltage, insert appropriate series resistors to limit the diode current to less than 5 mA maximum.

The input stage has two diodes between the input pins to protect the differential pair. Under high slew rate conditions, when the op amp is connected as a voltage follower, the diodes may become forward-biased and the source may try to drive the output. A small resistor should be placed in the feedback loop and in the noninverting input. The noise of a 100 Ω resistor at room temperature is ~ 1.25 nV/ $\sqrt{\text{Hz}}$, which is higher than the AD8597/AD8599. Thus, there is a tradeoff between noise performance and protection. If possible, limiting should be placed earlier in the signal path. For further details, see the *Amplifier Input Protection...Friend or Foe* article at http://www.analog.com/amplifier_input.

Because of the large transistors used to achieve low noise, the input capacitance may seem rather high. To take advantage of the low noise performance, impedance around the op amp should be low, less than 500 Ω . Under these conditions, the pole from the input capacitance should be greater than 50 MHz, which does not affect the signal bandwidth.

OUTPUT PHASE REVERSAL

Output phase reversal occurs in some amplifiers when the input common-mode voltage range is exceeded. As the common-mode voltage is moved outside the input voltage range, the outputs of these amplifiers can suddenly jump in the opposite direction to the supply rail. This is the result of the differential input pair shutting down that causes a radical shifting of internal voltages that results in the erratic output behavior.

The AD8597/AD8599 amplifiers have been carefully designed to prevent any output phase reversal if both inputs are maintained within the specified input voltage range. If one or both inputs exceed the input voltage range but remain within the supply rails, the op amp specifications, such as CMRR, are not guaranteed, but the output remains close to the correct value.

NOISE AND SOURCE IMPEDANCE CONSIDERATIONS

The AD8597/AD8599 ultralow voltage noise of 1.1 nV/ $\sqrt{\text{Hz}}$ is achieved with special input transistors running at high collector current. Therefore, it is important to consider the total input-referred noise (e_N total), which includes contributions from voltage noise (e_N), current noise (i_N), and resistor noise ($\sqrt{4 kTR_S}$).

$$e_N \text{ total} = [e_N^2 + 4 kTR_S + (i_N \times R_S)^2]^{1/2} \quad (1)$$

where R_S is the total input source resistance.

This equation is plotted for the AD8597/AD8599 in Figure 58. Because optimum dc performance is obtained with matched source resistances, this case is considered even though it is clear from Equation 1 that eliminating the balancing source resistance lowers the total noise by reducing the total R_S by a factor of 2.

At a very low source resistance ($R_S < 50 \Omega$), the voltage noise of the amplifier dominates. As source resistance increases, the Johnson noise of R_S dominates until a higher resistance of $R_S > 2 \text{ k}\Omega$ is achieved; the current noise component is larger than the resistor noise.

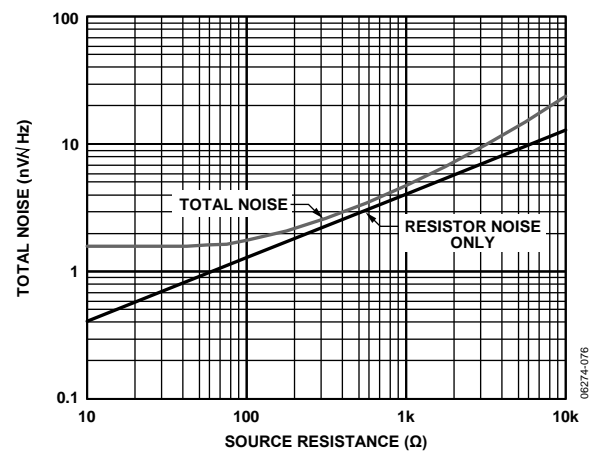

Figure 58. Noise vs. Source Resistance

The AD8597/AD8599 are the optimum choice for low noise performance if the source resistance is kept < 1 kΩ. At higher values of source resistance, optimum performance with respect to only noise is obtained with other amplifiers from Analog Devices. Both voltage noise and current noise need to be considered. For more information on avoiding noise from grounding problems and inadequate bypassing, see the AN-345 Application Note, *Grounding for Low- and High-Frequency Circuits*. For

general noise theory with extensive calculations, see the AN-358 Application Note, *Noise and Operational Amplifier Circuits*. A good selection table for low noise op amps can be found in AN-940 Application Note, *Low Noise Amplifier Selection Guide for Optimal Noise Performance*. An interesting note on using one section of a monolithic dual to phase compensate the other section is in the AN-107 Application Note, *Active Feedback Improves Amplifier Phase Accuracy*.

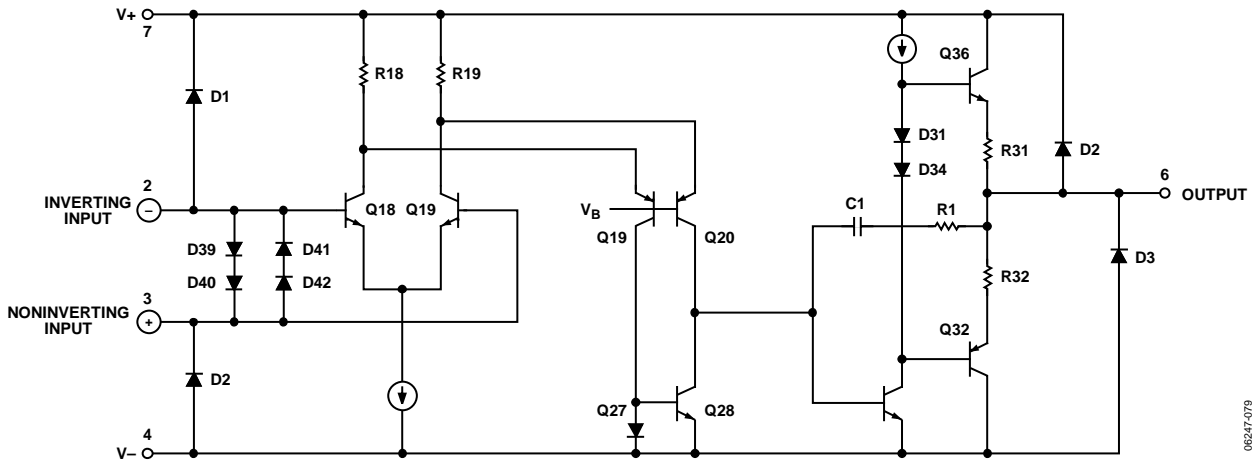
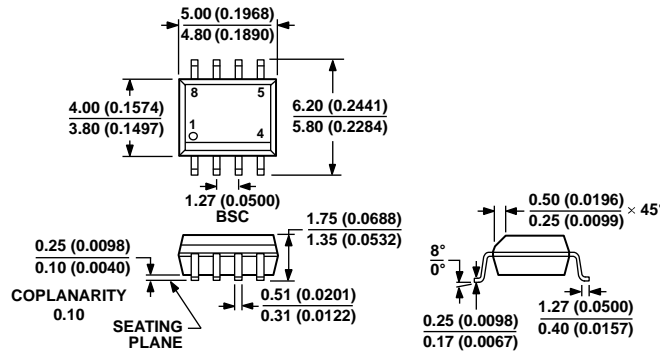

Figure 59. Simplified Schematic

06247-079

OUTLINE DIMENSIONS



COMPLIANT TO JEDEC STANDARDS MS-012-AA
 CONTROLLING DIMENSIONS ARE IN MILLIMETERS; INCH DIMENSIONS
 (IN PARENTHESES) ARE ROUNDED-OFF MILLIMETER EQUIVALENTS FOR
 REFERENCE ONLY AND ARE NOT APPROPRIATE FOR USE IN DESIGN.

Figure 60. 8-Lead Standard Small Outline Package [SOIC_N]
 Narrow Body (R-8)
 Dimensions shown in millimeters and (inches)

012407-A

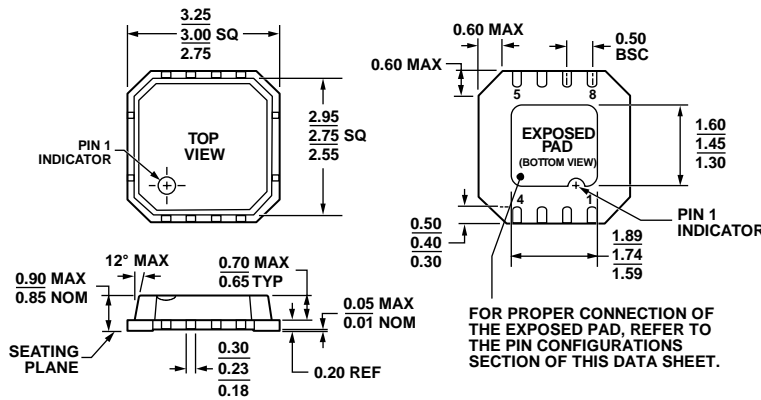

Figure 61. 8-Lead Lead Frame Chip Scale Package [LFCSP_VD]
 3 mm x 3 mm Body, Very Thin, Dual Lead
 (CP-8-2)
 Dimensions shown in millimeters

04-04-2012-A

ORDERING GUIDE

Model ¹	Temperature Range	Package Description	Package Option	Branding
AD8597ACPZ-R2	-40°C to +125°C	8-Lead Lead Frame Chip Scale Package [LFCSP_VD]	CP-8-2	A22
AD8597ACPZ-REEL	-40°C to +125°C	8-Lead Lead Frame Chip Scale Package [LFCSP_VD]	CP-8-2	A22
AD8597ACPZ-REEL7	-40°C to +125°C	8-Lead Lead Frame Chip Scale Package [LFCSP_VD]	CP-8-2	A22
AD8597ARZ	-40°C to +125°C	8-Lead Standard Small Outline Package [SOIC_N]	R-8	
AD8597ARZ-REEL	-40°C to +125°C	8-Lead Standard Small Outline Package [SOIC_N]	R-8	
AD8597ARZ-REEL7	-40°C to +125°C	8-Lead Standard Small Outline Package [SOIC_N]	R-8	
AD8599ARZ	-40°C to +125°C	8-Lead Standard Small Outline Package [SOIC_N]	R-8	
AD8599ARZ-REEL	-40°C to +125°C	8-Lead Standard Small Outline Package [SOIC_N]	R-8	
AD8599ARZ-REEL7	-40°C to +125°C	8-Lead Standard Small Outline Package [SOIC_N]	R-8	

¹ Z = RoHS Compliant Part.

NOTES

NOTES

NOTES

Данный компонент на территории Российской Федерации

Вы можете приобрести в компании MosChip.

Для оперативного оформления запроса Вам необходимо перейти по данной ссылке:

<http://moschip.ru/get-element>

Вы можете разместить у нас заказ для любого Вашего проекта, будь то серийное производство или разработка единичного прибора.

В нашем ассортименте представлены ведущие мировые производители активных и пассивных электронных компонентов.

Нашей специализацией является поставка электронной компонентной базы двойного назначения, продукции таких производителей как XILINX, Intel (ex.ALTERA), Vicor, Microchip, Texas Instruments, Analog Devices, Mini-Circuits, Amphenol, Glenair.

Сотрудничество с глобальными дистрибьюторами электронных компонентов, предоставляет возможность заказывать и получать с международных складов практически любой перечень компонентов в оптимальные для Вас сроки.

На всех этапах разработки и производства наши партнеры могут получить квалифицированную поддержку опытных инженеров.

Система менеджмента качества компании отвечает требованиям в соответствии с ГОСТ Р ИСО 9001, ГОСТ РВ 0015-002 и ЭС РД 009

Офис по работе с юридическими лицами:

105318, г.Москва, ул.Щербаковская д.3, офис 1107, 1118, ДЦ «Щербаковский»

Телефон: +7 495 668-12-70 (многоканальный)

Факс: +7 495 668-12-70 (доб.304)

E-mail: info@moschip.ru

Skype отдела продаж:

moschip.ru

moschip.ru_4

moschip.ru_6

moschip.ru_9