

DC Backup Block for S8TS

S8T-DCBU-01

CSM_S8T-DCBU-01_DS_E_7_1

DC Backup Block for S8TS Prevents 24-VDC Outages Due to Power Interruptions or Failures



- Supplies 24 VDC for a fixed period of time even during AC input outages to considerably improve system reliability.
- Block Power Supply Basic Block is connected using a Bus Line Connector to achieve a simple system configuration.
- Notification of alarms is provided by indications on the main unit and alarm signal output.
- RoHS-Compliant

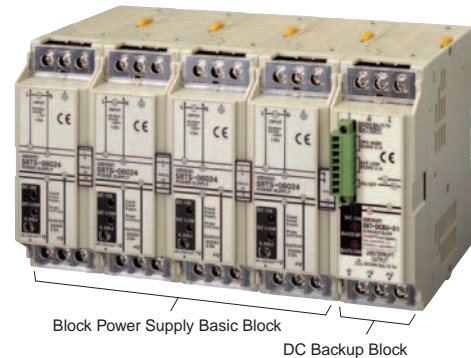

⚠ Refer to *Safety Precautions for All Power Supplies and Safety Precautions* on page 15.

For the most recent information on models that have been certified for safety standards, refer to your OMRON website.

Ordering Information

Note: For details on normal stock models, contact your nearest OMRON representative.

■ DC Backup Block (See note 1.)

| Input voltage | Output voltage | Output current | Model number |
|---------------|----------------|-------------------------|--------------|
| 24 to 28 VDC | 24 V | 3.7 A/8 A (See note 2.) | S8T-DCBU-01 |

- Note:** 1. One S8T-BUS03 Connector is included as an accessory.
 2. The output current can be selected by a switch.

■ Bus Line Connector

| Type | Number of Connectors | Model number |
|-----------------------|----------------------|--------------|
| DC Bus Line Connector | 1 | S8T-BUS03 |
| | 10 (See note.) | S8T-BUS13 |

Note: One package contains 10 S8T-BUS03 Connectors.

■ Basic Block

| Type | Output voltage/Output current | Model number |
|-------------------------|-------------------------------|-----------------------------|
| Screw terminal type | 24 V/2.5 A | With Bus Line Connectors |
| | | Without Bus Line Connectors |
| Connector terminal type | 24 V/2.5 A | With Bus Line Connectors |
| | | Without Bus Line Connectors |

Note: Use S8T-DCBU-01 in a pair with the Block Power Supply Basic Block.

■ Battery Holder

| Model number |
|--------------|
| S82Y-TS01 |

Note: Can be set two batteries.

■ Battery

| Model number |
|--------------|
| S82Y-BAT01 |
| S82Y-BAT02 |

Note: A set of two batteries.
 Designated battery varies on the number of multi-connected S8TS-06024□.
 Refer to "Number of Multi-Connected S8TS-06024□ and Designated Battery" on page 2.

Basic Configuration

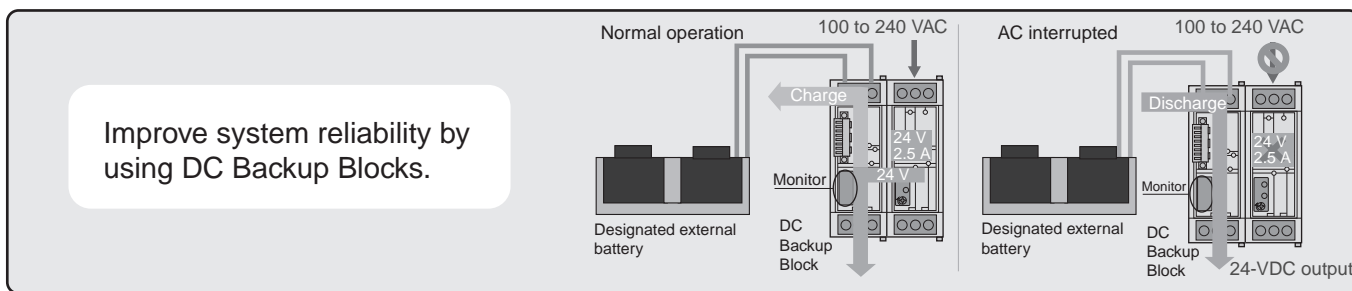
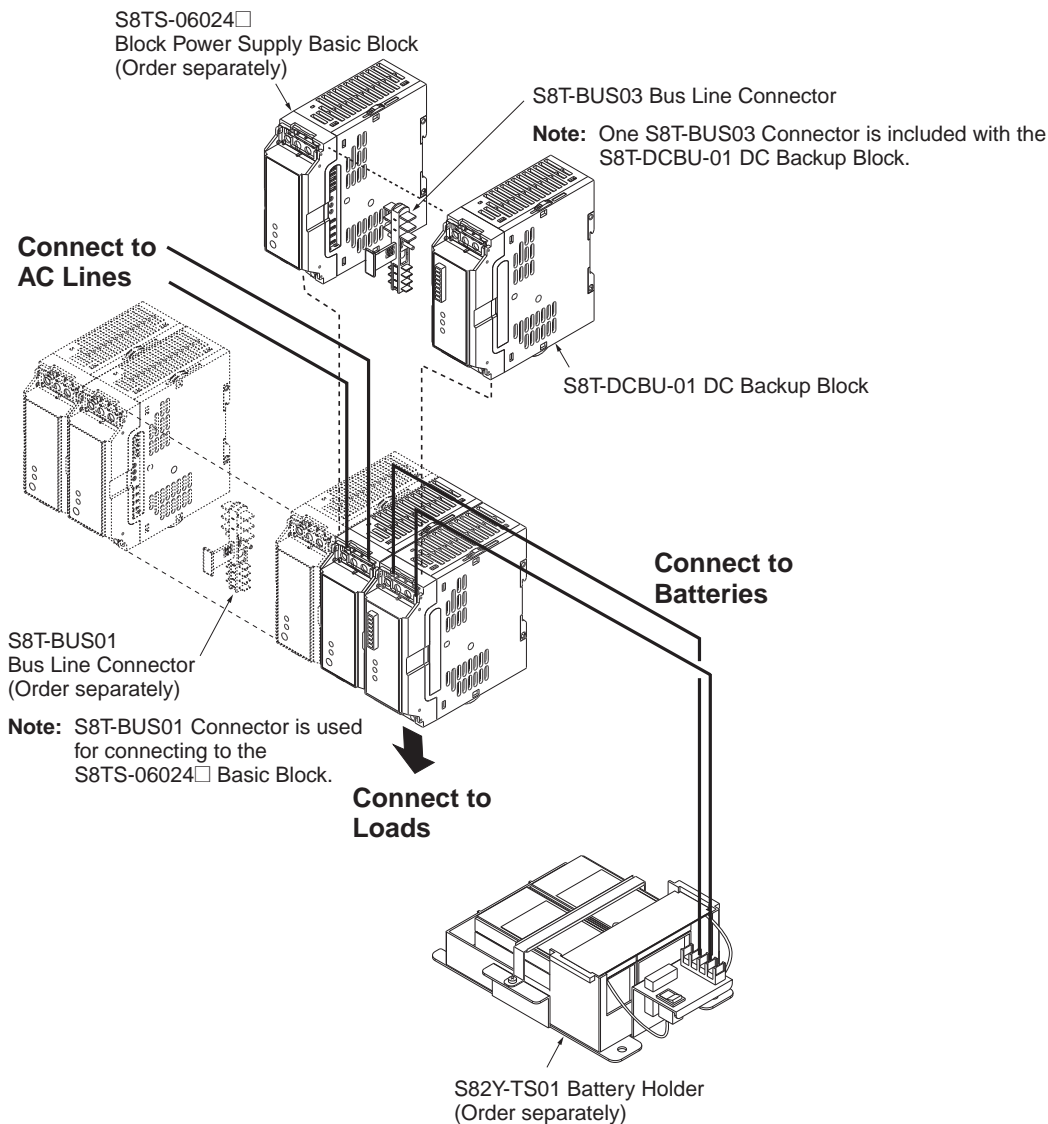

■ Number of Multi-Connected S8TS-06024□ and Designated Battery

| Area where battery is sold | | Japan | | Europe | | Areas other than Japan and Europe | |
|--|--|------------|------------|-------------|-------------|-----------------------------------|------------|
| | | S82Y-BAT01 | S82Y-BAT02 | LC-R122R2PG | LC-R123R4PG | LC-R122R2P | LC-R123R4P |
| Overload protection operating point selector | Max. No. of connected S8TS-06024□ units | | | | | | |
| 5.7 A (typical) | 2 (3 in the case of N+1 redundant operation) | Yes | Yes | Yes | Yes | Yes | Yes |
| 11.7 A (typical) | 4 (5 in the case of N+1 redundant operation) | — | Yes | — | Yes | — | Yes |

- Note:**
- The designated battery is rated at 12 V. Use two batteries in series.
 - S8T-DCBU-01 shall be connected with S8TS-06024□ when in use.
 - A set of two batteries.

Specifications

■ Ratings/Characteristics

| Item | | Model | S8T-DCBU-01 | |
|---|--------------------------------------|---|--|---|
| Input | | Voltage (See note 1.) | 24 to 28 VDC | |
| Output (See note 2.) | Normal operation | Voltage | 24 VDC (See note 3.) | |
| | | Load variation influence (See note 4.) | 6% max. | |
| | Backup operation | Voltage | 21.0 to 27.4 VDC (See note 5.) | |
| | | Min. output current (See note 6.) | S82Y-BAT01 | 0.11 A |
| | | | S82Y-BAT02 | 0.17 A |
| Backup time (reference value) (See note 7.) | S82Y-BAT01 | 8 min./3.7 A (at 25°C, battery fully charged, start of battery service life) | | |
| | S82Y-BAT02 | 4 min./8.0 A (at 25°C, battery fully charged, start of battery service life) | | |
| Charging | Method | | Stable voltage/current charging method | |
| | Charging voltage (See note 8.) | | 27.4 V/26.2 V (typical) | |
| | Max. charging current | | 0.35 A (typical) | |
| | Overvoltage protection (See note 8.) | | Yes (30 V typical) | |
| Additional functions | Protection functions | Overdischarge protection (See note 8.) | Yes (18.5 V typical) | |
| | | Overload protection (See note 8.) | Yes (5.7 A/11.7 A typical) | |
| | | Battery misconnection protection (See note 8.) | Yes | |
| | Input function | Backup ON/OFF input (See note 8.) | Yes | |
| | Output functions | Output indicator | Yes (color: green) | |
| | | Battery status indicator (See note 8.) | Yes (color: red) | |
| | | Battery status output (See note 8.) | Yes (relay: 24 VDC, 0.1 A) | |
| | | Backup status indicator | Yes (color: red) | |
| | | Operation mode output | Yes (relay: 24 VDC, 0.1 A) | |
| | Other | Ambient operating temperature (See note 4.) | | Operating: Refer to the derating curve in <i>Engineering Data</i> . (with no condensation or icing) Storage: -25 to 65°C |
| Ambient humidity | | Operating: 25% to 85%; Storage: 25% to 90% | | |
| Dielectric strength (See notes 4 and 9.) | | 3.0 kVAC for 1 minute (between all S8TS-06024□ AC inputs, and all S8T-DCBU-01 terminals/ all S8TS-06024□ outputs; detection current: 20 mA) 2.0 kVAC for 1 minute (between all S8TS-06024□ AC inputs and PE terminal; detection current: 20 mA) 1.0 kVAC for 1 minute (between all S8T-DCBU-01 terminals/all S8TS-06024□ outputs, and PE terminal; detection current: 20 mA) | | |
| Insulation resistance (See note 4.) | | 100 MΩ min. (between all S8T-DCBU-01 terminals and all S8TS-06024□ outputs, and between all S8TS-06024□ AC inputs and PE terminal) at 500 VDC | | |
| Vibration resistance (See notes 4 and 10.) | | 10 to 55 Hz, 0.375-mm single amplitude for 2 h each in X, Y, and Z directions | | |
| Shock resistance (See notes 4 and 10.) | | 150 m/s ² , 3 times each in ±X, ±Y, and ±Z directions | | |
| EMI (See note 4.) | | Conducted Emission | | Conforms to EN61204-3 EN55011 Class A and based on FCC Class A |
| | | Radiated Emission | | Conforms to EN61204-3 EN55011 Class A |
| EMS (See note 4.) | | Conforms to EN61204-3 High severity levels | | |
| Approved standards | | UL: | | UL508 (Listing: Class 2: Per UL1310) (See note 11.), UL60950-1 |
| | | cUL: cUR: EN/VDE | | CSA C22.2 No. 14 (Class 2: Per No.223) (See note 11.) No. 60950-1 EN50178 (=VDE0160), EN60950-1 (=VDE0805 Teil 1) |
| Size | | 120 × 120 × 43 mm | | |
| Weight | | 350 g | | |

- Note:**
1. Refer to *Output Voltage Adjustment for S8TS-06024□* on page 6.
 2. The output specifications are defined at power output terminals.
 3. Specified by performance of S8TS-06024□ Basic Block.
 4. Specified by S8TS-06024□ connection.
 5. The output voltage will be 21.0 V (min.) when switching to backup operation.
 6. The life of the battery will greatly reduced when operating below the minimum output. Design the loadcircuit so that at least the minimum output is maintained.
 7. Refer to *Backup Time (Reference Value)* on page 12.
 8. Refer to *Functions* on page 7 for details.
 9. Set the detection current to 20 mA × N, where N is the number of S8TS-06024□ Basic Blocks connected.
 10. Be sure to mount End Plates (PFP-M) on both ends of the Power Supply.
 11. To ensure Class 2, take one of following measures.

Note that the number of S8TS-06024□ to be connected to the S8T-DCBU-01 shall be one.

 - Connect S8T-DCBU-01 to S82Y-TS01 having its fuse replaced with an UL-Listed and DC rated 32 VDC min./3 A max. one.
 - Connect an UL-Listed and DC rated 32 VDC min./2.5 A max. fuse at the location shown in *Fig. 1*.

(Fig. 1)

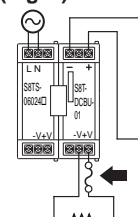

Connections

Block Diagram

S8T-DCBU-01

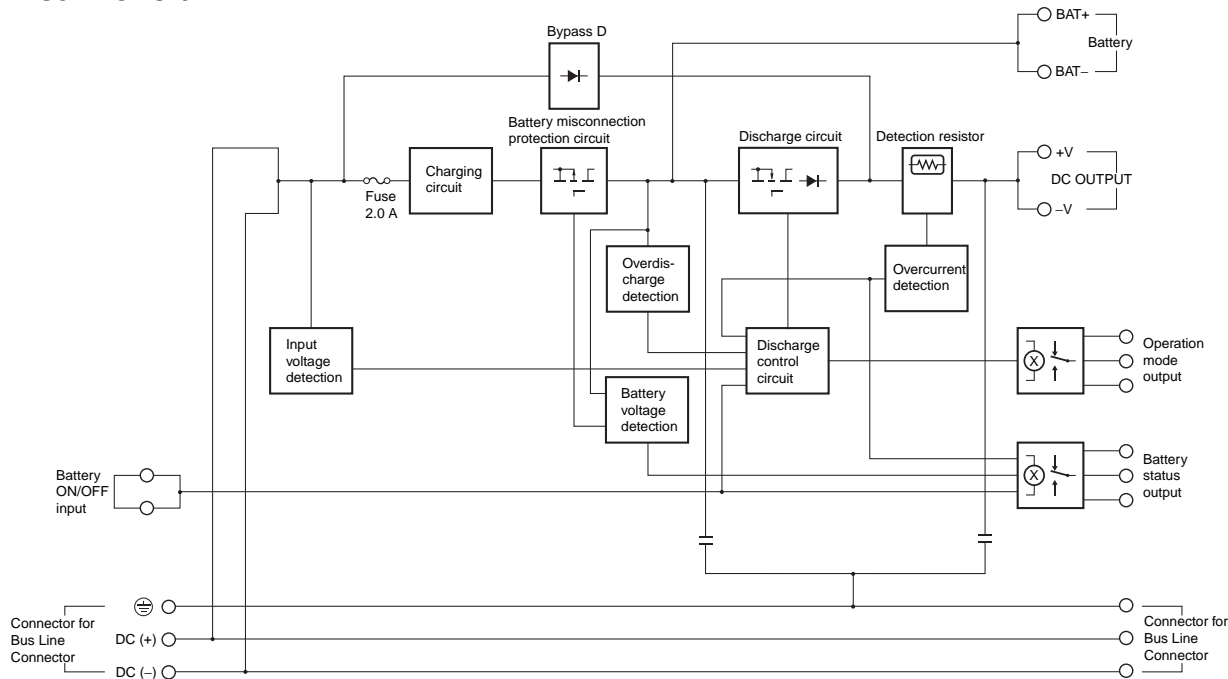

Operation

Operating Procedures

Battery Connection

Using the S82Y-TS01 Battery Holder is recommended for connecting and installing the battery. If the S82Y-TS01 is used, connect a switch and fuse between the battery and the S8T-DCBU-01. Refer to *Battery Holder S82Y-TS01* on page 6 for details on how to select and install the switch and fuse.

Battery Overdischarge

The battery will discharge according to the conditions given in items 1 to 3, below. Battery overdischarge may result in backup incapacity due to extremely shortened service life and an inability to recharge. Perform the following actions to prevent overdischarge.

1. Discharge Due to Load in Backup Operation (See note 1.)
Using the discharge protection function, rapid discharge is prevented by the battery connection terminal voltage automatically stopping backup operation at approximately 18.5 V. The standby current of the product, however, may result in continued discharge and overdischarge if discharge is performed after backup operation has been stopped. Therefore, refer to item 2.
2. Discharge Due to S8T-DCBU-01 Standby Current (See note 1.)
The AC power will turn OFF due to the standby current generated in the circuit configuration, and discharge will continue even if the load is no longer operating. In cases such as those described in *Table 1*, disconnect the battery to prevent overdischarge.
 - (1) Set the Battery Holder switch to OFF. (See notes 2 and 4.)
Connect the external circuit shown in *Figure 1* to protect against forgetting to change the switch. (See note 8.)
 - (2) Open the backup ON/OFF input using an external signal and disconnect the battery using an external relay. (See *Figure 1* and notes 2, 4, and 8.)

Table 1: Usage with Possible Overcharge Due to Standby Current

| | | Battery not disconnected | |
|--|---|---|---|
| | | Extreme shortening of battery life due to frequent backup operations or insufficient charging | Backup incapacity due to battery overcharge and inability to recharge |
| Turning OFF the AC power after assembly and installation (See note 7.) | | --- | Possible |
| Turning OFF the AC power during maintenance or inspection | | --- | Possible |
| Fre- quently turning the AC power OFF | Turning OFF the AC power during lunch breaks (1 hour/day) | Possible | --- |
| | Turning OFF the AC power at night (16 hours/day) | Possible | --- |
| | Turning OFF the AC power on Saturdays and Sundays | Possible | Possible |
| | Turning OFF the AC power during long vacations | --- | Possible |
| Storage or shipment | | --- | Possible |
| Long-term power outage | | --- | Possible |

Note:

1. The standby current of the S8T-DCBU-01 will cause the battery to discharge after backup operation has stopped because of the discharge protection function or the backup ON/OFF input is opened.
2. Before turning ON the AC power, turn OFF the Battery Holder switch or switch SW shown in *Figure 2*. Unnecessary backup operation will shorten the service life of the battery because of the two reasons listed below. Also, be sure to turn ON the Battery Holder switch or switch SW shown in *Figure 2* when turning ON the AC power.

- A period of 24 to 48 hours is required to fully charge the battery. If backup operation is performed before the battery is fully charged, the reduced charge will result in shortened battery service life.
 - The battery service life will be shortened with each repetition of charging and discharging.
- If the battery connection terminal voltage is 15.5 V (typical) or lower, the incorrect battery connection protection function will be activated, and charging will not be performed. When the battery is nearing the end of its service life (i.e., when the battery capacity is half its initial capacity), recharging and backup may not be possible if only the battery has been left turned AC power OFF for about two days (at an ambient temperature of 25°C). Refer to *Incorrect Battery Connection Protection* on page 8.
 - Do not use the S8T-DCBU-01 in locations subject to corrosive gases, such as silicon gas, sulfuric gas, organic gas, or chlorine gas. If relays (X in *Figure 1* and *Figure 2*) or switches (Battery Holder and switch SW in *Figure 2*) are used or left in atmospheres with corrosive gas, corroded contact surfaces may cause contact instability or contact failure and render battery backup or backup operation impossible.
 - The ambient operating temperature and humidity for the LY1-D (24 VDC) are given in the following table. The LY1-D (24 VDC) has a built-in diode to absorb inverted voltage that is generated from the operating coil. The operating coil therefore has polarity. Take this into account when performing wiring. Refer to individual datasheets for details.

| Model | Ambient operating temperature | Ambient operating humidity |
|----------------|--|----------------------------|
| LY1-D (24 VDC) | Output current of 4 A max.: -25 to 55°C Output current of 4 A min.: -25 to 40°C | 5% to 85% |

- A voltage of approximately 15 V is applied to switch SW in *Figure 2* when it is open and a current of approx. 2 mA when it is shorted. Take this into account when selecting a switch.
- The standby current will flow and discharging will continue if only the battery is wired and left without wiring the AC power.
- If the user has forgotten to turn OFF the Battery Holder switch in *Figure 1* or switch SW in *Figure 2*, backup operation will continue until the battery connection terminal voltage reaches 18.5 V (typical), and then the battery will be disconnected by the relay (X). If the battery is left in this condition for a period exceeding the times given in the following table, self-discharge will cause the battery to continue overdischarging, which may result in the inability to recharge and perform backup.

| S82Y-BAT01 | | | |
|---------------------|--------------|--|---------------------|
| Ambient temperature | Load current | Estimated months battery can be left until incapable of recharging | |
| | | Start of battery life | End of battery life |
| 20°C | 0.11 A | 1.0 | 0.5 |
| | 2.2 A | 2.0 | 1.0 |
| 40°C | 0.11 A | 0.5 | 0.25 |
| | 2.2 A | 1.0 | 0.5 |

| S82Y-BAT02 | | | |
|---------------------|--------------|--|---------------------|
| Ambient temperature | Load current | Estimated months battery can be left until incapable of recharging | |
| | | Start of battery life | End of battery life |
| 20°C | 0.17 A | 1.0 | 0.5 |
| | 4.8 A | 3.0 | 1.5 |
| 40°C | 0.17 A | 0.5 | 0.25 |
| | 4.8 A | 3.0 | 1.5 |

Figure 1 Overdischarge Protection Circuit When the User Forgets to Turn OFF the Battery Holder Switch

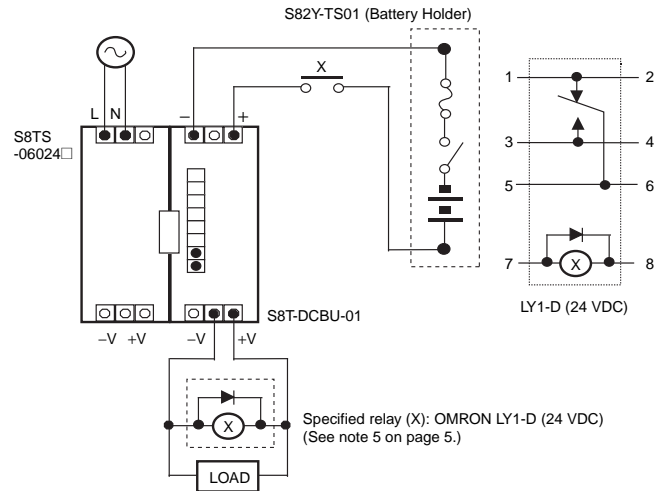

The following will occur if you forget to turn OFF the Battery Holder switch.

- Backup operation will start after the AC power has been turned OFF.
- When the battery connection terminal voltage reaches 18.5 V (typical), backup operation will stop, the relay contacts will open, and the battery will be disconnected from the DC Backup Block.

Figure 2 Overdischarge Protection Circuit Using an External Signal

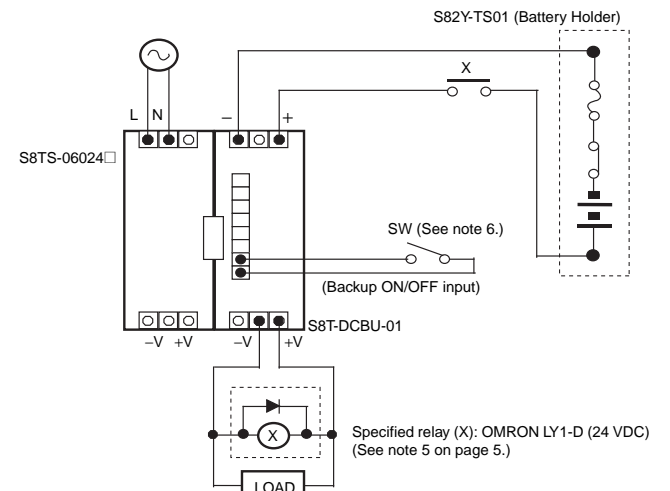

- The backup ON/OFF input is opened (making backup impossible) by the external signal (e.g., a switch).
 - If the AC power has been turned OFF, 24 VDC will turn OFF, the contacts will open, and the DC Backup Block will be disconnected.
- Battery Discharge Due to Self-discharging**
Even if the S8T-DCBU-01 Battery is disconnected, it will discharge naturally. To prevent overdischarge, charge the Battery completely before storing it for an extended period of time or shipping it, and then charge it at the interval given below.

| Ambient temperature | Months between charging |
|---------------------|-------------------------|
| 20°C or less | 9 |
| 20 to 30°C | 6 |
| 30 to 40°C | 3 |

Backup Function

S8T-DCBU-01 detects output voltage drop of S8TS-06024□ to switch to backup operation.

Indicator **Operation mode**
output relay



LED lit
(DC ON: Green)

LED lit
(BACKUP: Red)

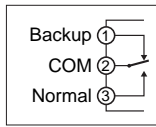

Relay (OPN MODE)
(1)-(2): ON

Backup operation continues for about 7 seconds even after the output voltage of S8TS-06024□ is restored.

| | Backup status | LED (BACKUP: Red) | Relay (OPN MODE) |
|---|---|---|---|
| Power failure | Continuous backup operation | Lit | Backup (1)-(2): ON |
| Failure of one unit of S8TS-06024□ | During operation of one unit of S8TS-06024□ | | |
| | During operation of multiple units of S8TS-06024□ | Repetition of switching between Normal operation and Backup operation at an interval of about 7 seconds | Repetition of switching between Normal ((3)-(2): ON) and BACK UP ((1)-(2): ON) at an interval of about 7 seconds. |
| Upon activation of overload protection function of S8TS-06024□ (See note.) | Repetition of switching between Normal operation and Backup operation at an interval of about 7 seconds | | |

Note: (1) If this state occurs, the S8TS-06024□ may be overloaded or malfunctioning. Immediately eliminate the cause of the trouble.

- (2) If switching between backup operation and normal operation is repeated, the output voltage changes accordingly.
- (3) The contact capacity of the relay is 24 VDC 0.1 A.
- (4) Do not use the S8TS-06024□ with sudden load fluctuations or load peaks exceeding the rated current. Doing so will cause the output voltage of the S8TS-06024□ to drop and backup to be performed, and may shorten the battery service life.
- (5) The maximum inrush current specified below flows when backup operation starts.

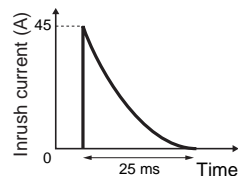

Battery charge status: Fully charged
Battery ambient temperature: 40°C
Input capacitor of connected equipment: 56,000 μF
Load power: 192 W

Charging Circuit

Charging Time (Reference Values)

| Battery used | 100% charged | 80% charged |
|--------------|----------------|-------------|
| LC-□122R2□□ | 24 to 48 hours | 5 hours |
| LC-□123R4□□ | | 8 hours |

Note: The battery takes the time specified above to be charged. If power is interrupted for shorter than the necessary charging time (i.e., power failure immediately after installation or repeated short power failures), backup operation may not continue for the necessary time.

Output Voltage Adjustment for S8TS-06024□

The DC Backup Block detects a drop in the output voltage (approx. 23 VDC) of the connected S8TS-06024□ to switch to backup operation.

The output voltage of the S8TS-06024□ can be adjusted using the output voltage adjuster. Do not, however, set the output voltage to lower than the factory shipment setting, if the S8TS-06024□ is used connected with a DC Backup Block.

Wiring Length between S8T-DCBU-01 and Battery

Connect S8T-DCBU-01 and the battery using a cable having a wire diameter specified in *Recommended Wire Diameter* on page 16 within a wiring length of 1.5 m.

Because the battery voltage is monitored at the battery connecting terminal, a large wiring impedance increases the voltage drop from wiring, reducing the backup time.

Battery Holder S82Y-TS01

We recommend using the S82Y-TS01 Battery Holder for connecting and installing the battery. Take the following points into consideration when using the S82Y-TS01:

- (1) Contact between leaking battery fluid and metal parts having an electric potential may cause ignition or fire. To prevent this, the Battery Holder uses a resin battery tray. Install the Battery Holder in the direction shown in the following figure.

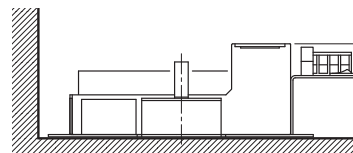

- (2) The inrush current shown below flows when backup operation is switched to. The peak value and time of this inrush current vary according to the capacity of the input capacitor of the connected equipment, battery charge status, battery wiring length, and ambient temperature. The switch and fuse of the S82Y-TS01 are selected taking this inrush current into consideration. When replacing the fuse, use only the specified fuse. (Littelfuse, 0287015* (15 A))

* The previously specified 257015 has been discontinued.

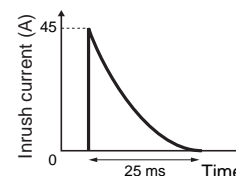

Battery charge status: Fully charged
Battery ambient temperature: 40°C
Input capacitor of connected equipment: 56,000 μF
Load power: 192 W

- (3) In the event that the battery generates inflammable gases, place the switch and fuse away from the convection path of the inflammable gas to prevent the switch or fuse from causing ignition and explosion.
- (4) If the S8T-DCBU-01 is stored with the AC power tuned OFF but the battery still connected, the standby current of the S8T-DCBU-0 may cause the battery to discharge, considerably reduce the service life of the battery, and render recharging and backup impossible. To prevent this, turn OFF the switch. (Refer to *Battery Overdischarge* on page 4.)

Inserting and Removing the Bus Line Connector

Pay attention to the following points to maintain electric characteristics.

- Do not insert/remove the Connectors more than 20 times.
- Do not touch the Connector terminals.
- To remove the Connectors, insert a flat-bladed screwdriver alternately at both ends.

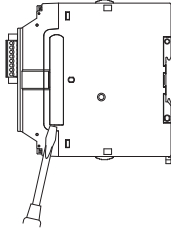

S8T-BUS03

Use the S8T-BUS03, which connects only the DC lines. (AC line not connected).

S8T-BUS03 is equipped with a selector to prevent incorrect connection to a power supply unit with a different output voltage specification. Slide the selector to the 24 V position.

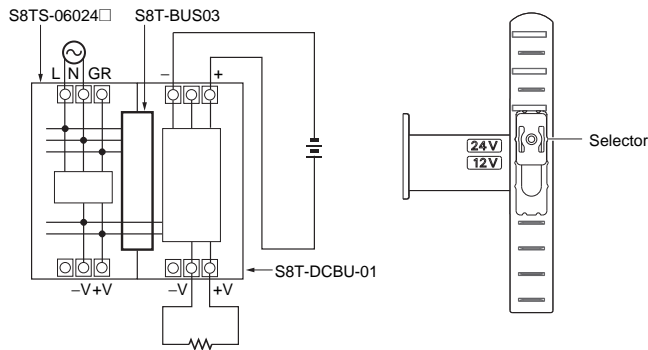

Mounting

Mounting Direction

| | |
|-------------------|-----|
| Standard mounting | Yes |
| Face-up mounting | No |
| Other mounting | No |

Use standard mounting only. Improper mounting will interfere with heat dissipation and may result in deterioration or damage to internal parts.

Standard mounting
Correct

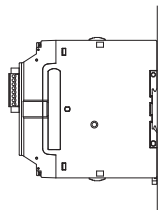

Face-up mounting
Incorrect

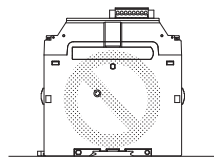

Operation Check

After connecting the S8TS-06024 and S8T-DCBU-01, it is recommended to use the following procedure to check whether the DC Backup Block is operating correctly.

- Turn ON the Battery Holder.
- Turn ON the AC power of the S8TS-06024.
- Wait for at least 10 s, and then check if the DC Backup Block is in the following status.

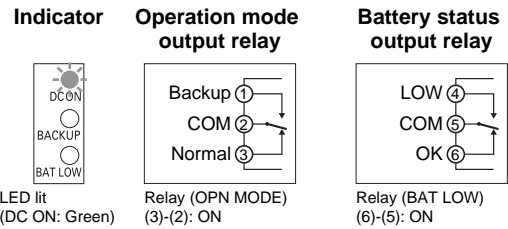

- Turn OFF the AC power of the S8TS-06024.
- Confirm that backup operation is correctly performed as shown below.

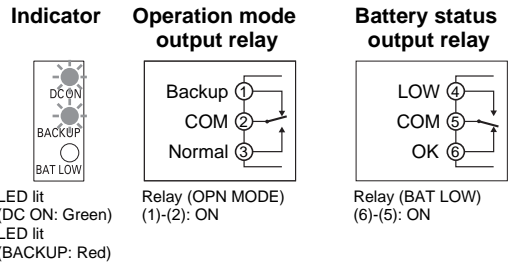

- Turn ON the AC power of the S8TS-06024.
- Note:**
- Check operation after arranging a state where no fault occurs even if the connected devices are turned OFF in the midway.
 - The operation mode may not be changed to Backup, if AC power is turned OFF within 10 sec. at Step 3.
 - After checking operation, follow the points listed in *Battery Overdischarge* on page 4 if the AC power is turned OFF or the equipment is stored or shipped.

Functions

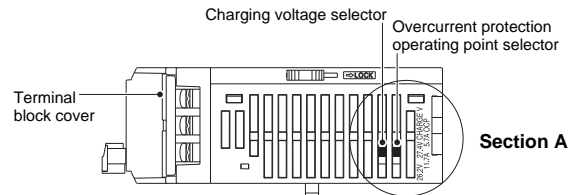

Charging Voltage Selector

Select either 27.4 V or 26.2 V at the charging voltage selector to select the charging voltage.

The shipment setting is 27.4 V.

Because the battery manufacturer recommends 27.4 V as charging voltage, it is recommended to charge at 27.4 V.

In this case, 27.4 VDC, which is the charging voltage of the batteries, may output depending on the state of connected load when the operation mode changes to Backup.

Note: If the battery is charged at 26.2 V, the battery capacity decreases each time the battery is charged, and the backup time gradually decreases.

The values shown below are for reference only.

| | Capacity reduction in each charge-and-discharge cycle |
|---------|---|
| At 25°C | Reduction by 10% |
| At 0°C | Reduction by 20% |

Enlarged View of Section A

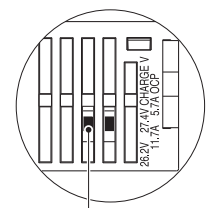

Charging voltage selector

Overvoltage Protection Circuit

If the charging voltage is about 30 V or above, the charging voltage is cut off to prevent the battery from being overcharged.

How to Reset Overvoltage Protection

Reset Overvoltage protection with following steps after arranging a state where no fault occurs even if the connected devices are turned off in the midway.

1. Turn OFF the Battery Holder.
2. Turn OFF the AC power of the S8TS-06024□.
3. Leave the power OFF for 1 minute or more.
4. Turn ON the Battery Holder.
5. Turn ON the AC power of the S8TS-06024□ again.

Note:

1. Do not turn ON the input power again until the cause of the overvoltage has been removed.
2. As an AC input OFF status is the same as a power failure, the S8T-DCBU-01 will perform backup operation. Sometimes backup operation cannot be performed for the required backup time as the battery is not sufficiently charged. For this reason, first make sure that backup operation is not needed before turning the battery holder OFF and then the AC input power OFF.
3. The time required for reset is specified for connection of five units of S8TS-06024□, without a load, and fully charged batteries.

Overload Protection Operating Point Selector

5.7 A (typical) or 11.7 A (typical) can be selected with the selector as an overload protection operating point during backup operation. Select 5.7 A (typical) for one or two units of S8TS-06024□ (or three units during N+1 redundancy operation), or select 11.7 A (typical) for three or four units (or five units during N+1 redundancy operation). The shipment setting is 5.7 A (typical).

Enlarged View of Section A

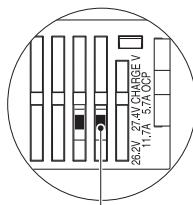

Overload protection operating point selector

Overload Protection Function

During Normal Operation

Notification of an overload status is provided in the following way.

- LED (BAT LOW: Red) lights up.
- Relay (BAT LOW) is in the LOW mode ((4)-(5): ON).

If power failure occurs in this state, an overload protection function is activated to fail to backup.

During Backup Operation

The overload protection operating point can be selected from either 5.7 A (typical) or 11.7 A (typical) using the overload protection function selector. The output is cut off when overload protection is activated.

Note: Continuation of operation in the overload status may cause deterioration or damage to internal parts.

Overdischarge Protection Function

When the battery connecting terminal voltage drops down to about 18.5 V, backup operation is automatically stopped to protect the battery against overdischarge.

Note:

1. The standby current of the S8T-DCBU-01 will cause overdischarge to continue even after backup operation has stopped. Do not leave the S8T-DCBU-01 for extended periods in this condition. (Refer to *Battery Overdischarge* on page 4.)
2. The residual capacity of the battery is zero when the battery voltage is 18.5 V (typical).

Backup ON/OFF Input Function

If the backup ON/OFF input terminals are short-circuited, backup is enabled, while if the terminals are open, backup is disabled. The terminal is non-voltage input type and the short and open circuits are specified below.

| | |
|--------------|--|
| Short | Impedance: 1 kΩ or below Flowing current at 0 Ω: About 2 mA Residual voltage: 1 V or below |
| Open | Impedance: 400 kΩ or more |

With the shipment setting, a short bar is installed to short-circuit across the backup ON/OFF input terminals.

When the backup ON/OFF input terminals are open, the following signs inform that backup is disabled.

- LED (Battery status indicator/BAT LOW: Red) is lit.
- Relay (Battery status output/BAT LOW) is in the LOW mode ((4)-(5): ON).

Note: The standby current of the S8T-DCBU-01 will cause overdischarge to continue even after backup operation has stopped. Do not leave the S8T-DCBU-01 for extended periods in this condition. (Refer to *Battery Overdischarge* on page 4.)

Incorrect Battery Connection Protection

When the DC Backup Block is turned ON, the charging circuit is separated if battery connection terminal voltage becomes below about 15.5 V. This function protects the battery and the main body upon incorrect connection of the batteries (with reverse polarity or with only one 12 V battery).

If an incorrect battery connection is detected, notification will be provided the following ways.

- LED (Battery status indicator/BAT LOW: Red) is lit.
- Relay (Battery status output/BAT LOW) is in the LOW mode ((4)-(5): ON).

Note: (1) After the battery has been properly connected, the battery status display and output will not respond even if the battery is disconnected (Battery Holder switch set to OFF, Battery Holder fuse blown, battery connection wiring disconnected) with the AC power turned ON.

(2) Do not replace the battery while power is being supplied. If the battery is replaced while power is being supplied, the incorrect battery connection protection will not operate even if the battery is connected with the polarity reversed. The S8T-DCBU-01 will be damaged and the Battery Holder fuse will blow.

Battery Status Indication and Battery Status Output

Notification of a battery charging/discharging fault (1. through 4. described below) is provided in the following way.

Indicator Battery status output relay

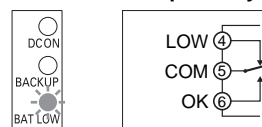

LED lit (BAT LOW: Red)

Relay (BAT LOW) (4)-(5): ON

If power failure occurs in this state, backup operation does not start or the backup time becomes shorter. Remove the cause of the fault immediately.

1. The battery connection terminal voltage is approx. 22.5 V or lower. (BAT LOW will be cleared when the voltage reaches or exceeds approx. 24.5 V.) (See note 1.)
2. The incorrect battery connection protection detected an incorrect connection.
3. The battery ON/OFF input terminals are open.
4. An overload status exists during normal operation.

Note:

1. BAT LOW being cleared does not mean that battery charging has been completed.
2. The contact capacity of the relay is 24 VDC 0.1 A.

Battery Replacement

Sealed lead-acid batteries have a limited service life.

Fire may be caused in the worst case if the batteries are used beyond their time for replacement. Replace batteries periodically to avoid the worst case by referring to the following replacement procedure.

- Note:**
1. Battery deterioration accelerates when its service life limit draws near.
 2. The battery replacement timing assumes the battery has reached half its original capacity.
 3. The life varies according to the storage and operating environment, output wattage, and the frequency of backup operation.
 4. Follow procedures specified by voluntary or regulatory regulations when disposing of or recycling batteries.
 5. Do not replace the battery while power is being supplied. If the battery is replaced while power is being supplied, the incorrect battery connection protection will not operate even if the battery is connected with the polarity reversed. The S8T-DCBU-01 will be damaged and the Battery Holder fuse will blow.

1. Replacement Guideline

Replace the battery using the following table as a guideline:

| Battery | Ambient temperature | Life of battery | Approximate replacement interval |
|-------------|---------------------|-------------------|----------------------------------|
| LC-R122R2□□ | 20 •C | 2 to 3 years | 2 years |
| LC-R123R4□□ | 30 •C | 1 to 1.5 years | 1 years |
| | 40 •C | 0.5 to 0.75 years | 0.5 year |
| LC-P122R2□□ | 20 •C | 4 to 6 years | 4 years |
| LC-P123R4□□ | 30 •C | 2 to 3 years | 2 years |
| | 40 •C | 1 to 2 years | 1 year |

Note: The conditions in the table above is estimated as: charged at 27.4 V, discharged with 8 A (for LC-□123R4□□), 3.7 A (LC-□122R2□□), backup operation once a month bases.

2. Measuring Backup Time

The backup time can be measured by the procedure below. If the battery is new, first measure the initial backup time value.

Replace the battery if backup operation is not performed for the required backup time during periodic maintenance or the backup time has fallen below the half or less of initial value.

- Note:**
1. Make sure that at least 48 hours have elapsed since the previous backup operation, and that the battery is correctly connected, and then measure the backup time.
 2. Measure the backup time after making sure that no problems will occur as a result of stopping the power supply.

- (1) Turn the AC power OFF and back up the S8T-DCBU-01.
- (2) Measure the time that the battery status output relay turns to LOW ((4)-(5): ON) after the operation mode output relay is backed up ((1)-(2): ON). (This is the backup time.)
- (3) When the battery status output relay turns LOW ((4)-(5): ON), turn the AC power ON.

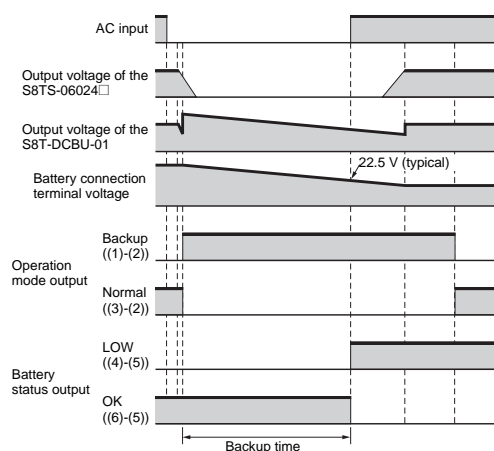

Periodic Inspection of the Battery

We recommend periodically inspecting the battery as follows:

- Check the battery voltage. (In a 27.4 V series connection, make sure that each battery is charged to 13.7 V.)
- Check battery wiring and connections. (Check the batteries and S8T-DCBU-01 connections for loose screws.)
- Make sure that backup operation is performed normally in a simulated power failure state.

Note: Check the backup operation after making sure that no problems will occur as a result of stopping the power supply.

Installation

DC Backup Block

S8T-DCBU-01

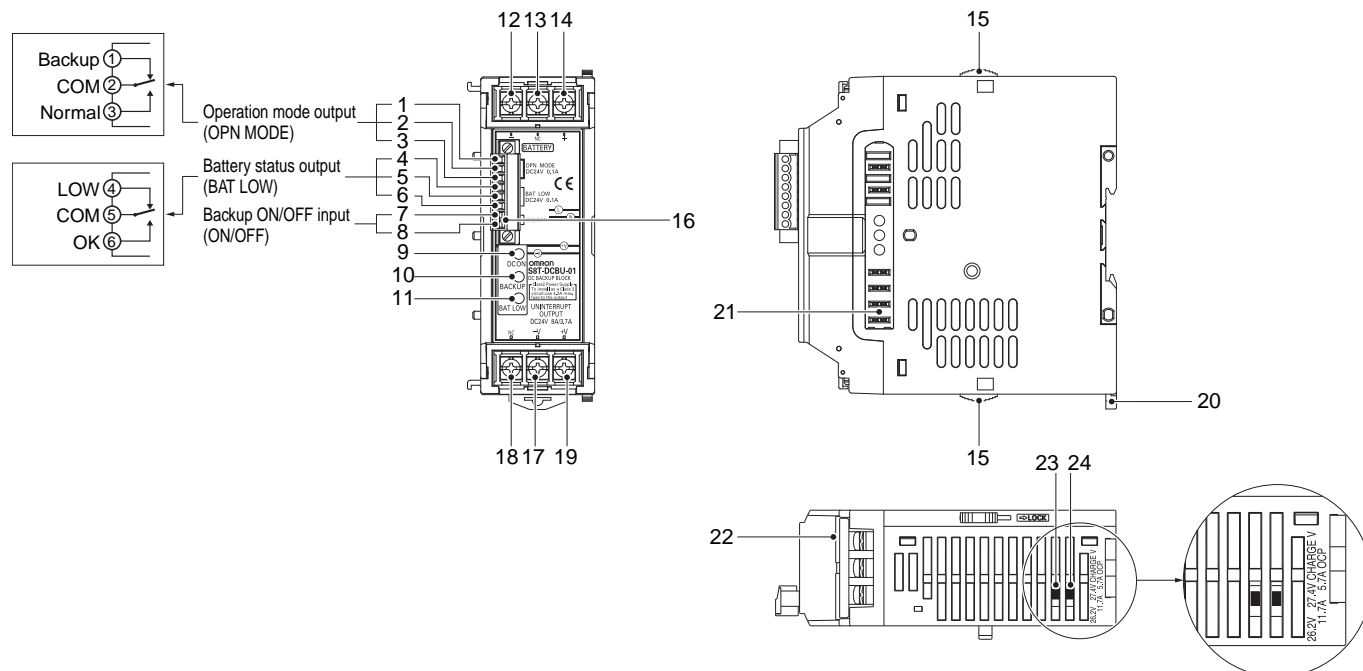

- | | | |
|---|--|--|
| (1) Backup: Operation mode output relay | (9) Output indicator (DC ON: Green) | (17) DC output terminal (-V) |
| (2) COM: Operation mode output relay | (10) Backup status indicator (BUCKUP: Red) | (18) NC |
| (3) Normal: Operation mode output relay | (11) Battery status indicator (BAT LOW: Red) | (19) DC output terminal (+V) |
| (4) LOW: Battery status output relay | (12) Battery connector terminal (-) | (20) Rail stopper |
| (5) COM: Battery status output relay | (13) NC | (21) Bus line connector |
| (6) OK: Battery status output relay | (14) Battery connector terminal (+) | (22) Terminal block cover |
| (7) ON/OFF: Backup ON/OFF input | (15) Slider | (23) Charging voltage selector |
| (8) GND: Backup ON/OFF input | (16) Short bar | (24) Overload protection function selector |

Bus Line Connector

S8T-BUS03

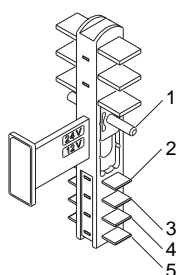

- (1) Selector
- (2) Ground Terminal
- (3) NC
- (4) DC Bus Line Connector Terminal (+)
- (5) DC Bus Line Connector Terminal (-)

Battery Holder

S82Y-TS01

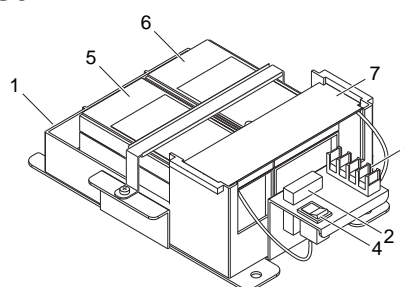

- (1) Battery Tray
- (2) Fuse
- (3) Terminal Block
- (4) Switch
- (5) Battery A (Order separately)
- (6) Battery B (Order separately)
- (7) Protection Cover

Engineering Data

Derating Curve

| Number of S8TS-06024□ units | S8TS-06024□ rated input | Derating curve | Rated output power |
|-----------------------------|-------------------------------|----------------|--------------------|
| 1 | 200 to 240 VAC | *1 | 36 W |
| | 100 to 120 VAC | *2 | |
| 1 (+1) | 100 to 120 VAC/200 to 240 VAC | *3 | 30 W |
| 2 | | *4 | 88.8 W |
| 2 (+1) | | *5 | 76.8 W |
| 3 | | *6 | 146.4 W |
| 3 (+1) | | *7 | 128.4 W |
| 4 | | *8 | 192 W |
| 4 (+1) | | *9 | 168 W |

Note: 1. "(+1)" indicates redundant operation.

- If there is derating problem, use forced air cooling.
- The ambient temperature is specified at a location 50 mm downward from the main body of the DC Backup Block.
- The ambient operating temperature range of the battery is 0 to 40°C; it is different from that of S8T-DCBU-01. And the ambient temperature of battery is specified with the temperature at the battery surface.
- The amount of output wattage at multi-connected S8TS-06024□ become smaller than the simple sum of each wattage, since S8T-DCBU-01 consumes energy from S8TS-06024□.

S8T-DCBU-01

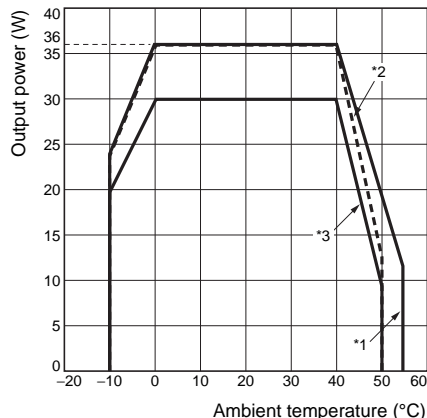

S8T-DCBU-01

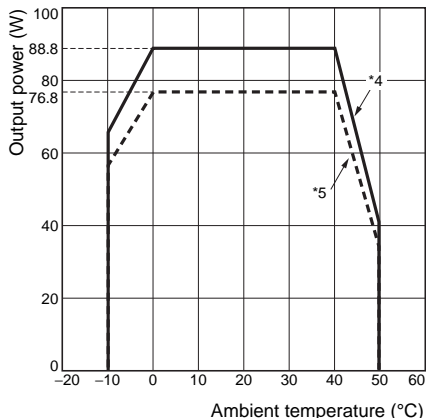

S8T-DCBU-01

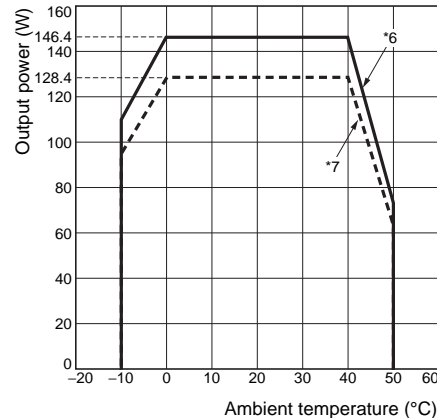

S8T-DCBU-01

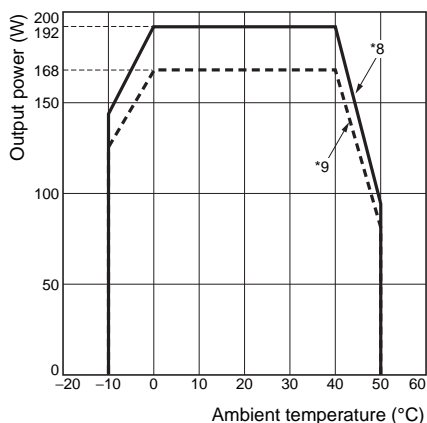

Time Charts

Startup

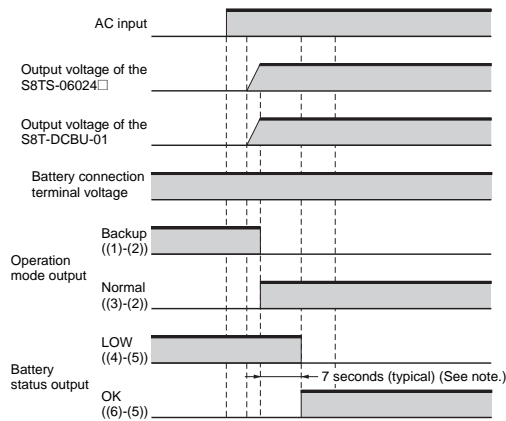

Note: Backup operation is not possible during the period (7 seconds (typical)) that the battery status output relay is LOW after the S8T-DCBU-01 is started up.

Power Failure (When the Battery Voltage does not Reach the BAT LOW Voltage)

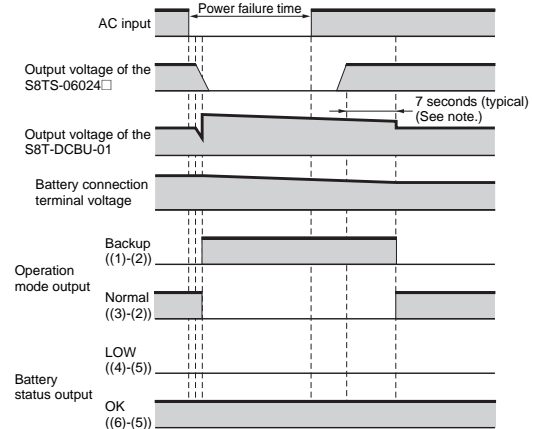

Note: Backup operation is continued for seven seconds (typical) after the power is restored from a power failure.

Power Failure (When the Battery Voltage Reaches the BAT LOW Voltage)

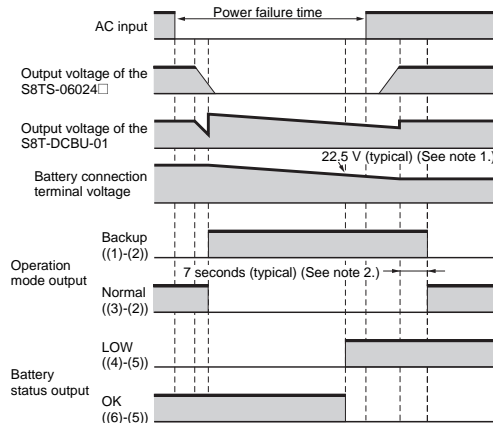

- Note:**
- When the battery voltage falls below 22.5 V (typical), the status of the battery status output relay changes to LOW.
 - Backup operation is continued for seven seconds (typical) after the power is restored from a power failure.

Power Failure (When the Battery Voltage Reaches the Overdischarge Protection Voltage)

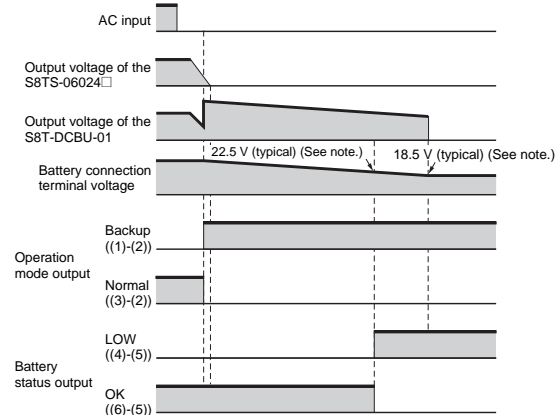

Note: When the battery voltage falls below 22.5 V (typical), the status of the battery status output relay changes to LOW. Backup operation is stopped when the battery voltage falls below 18.5 V (typical). If the battery is left with backup operation stopped, the standby current of the S8T-DCBU-01 may cause the battery to continue discharging, considerably reduce the service life of the battery, and render recharging and backup impossible. To prevent this, refer to *Battery Overdischarge* on page 4.

Backup Time (Reference Value)

Backup Time when LC-□122R2□□ is Used

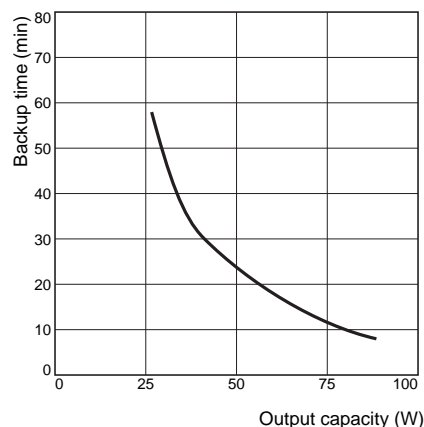

Backup Time when LC-□123R4□□ is Used

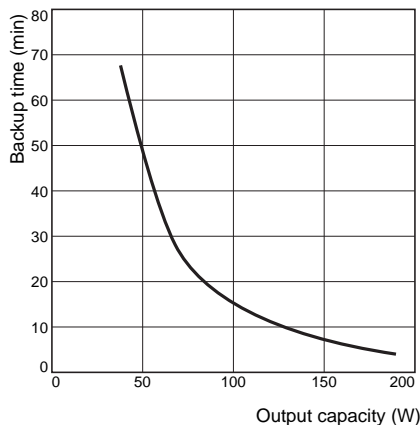

- Note:**
- Backup time conditions
 - Backup time: Time from start of backup until output voltage reaches 21.0 V.
 - Ambient temperature: 25°C
 - Battery: New product fully charged to 27.4 V
 - Length of wire between S8T-DCBU-01 and battery: 1.5 m
 - The backup time changes depending on the capacity of connected equipment, ambient temperature, and battery service life.

Dimensions

Note: All units are in millimeters unless otherwise indicated.

DC Backup Block

S8T-DCBU-01

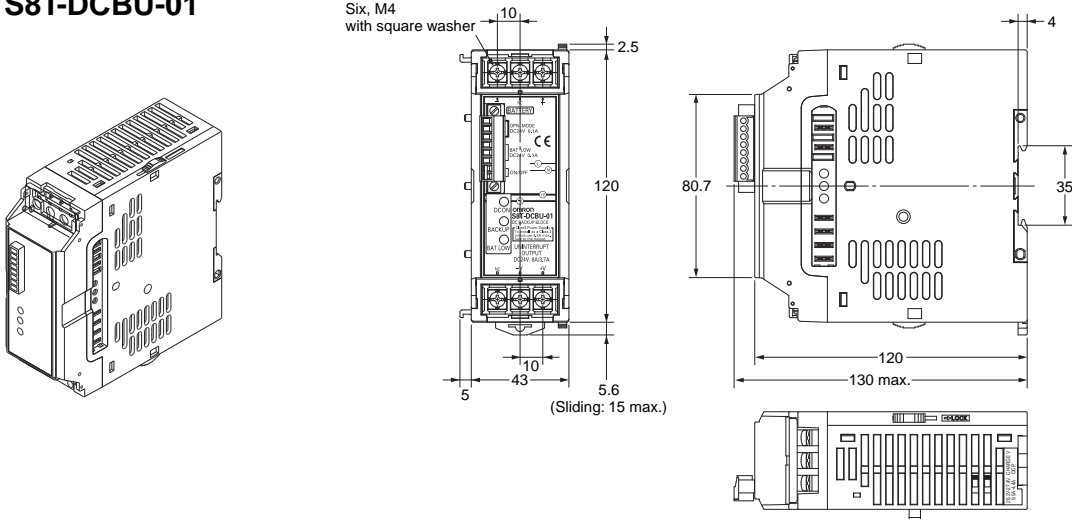

Bus Line Connector

S8T-BUS03

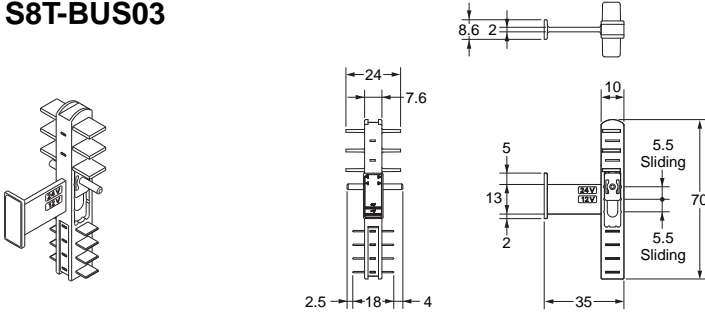

Battery Holder

S82Y-TS01

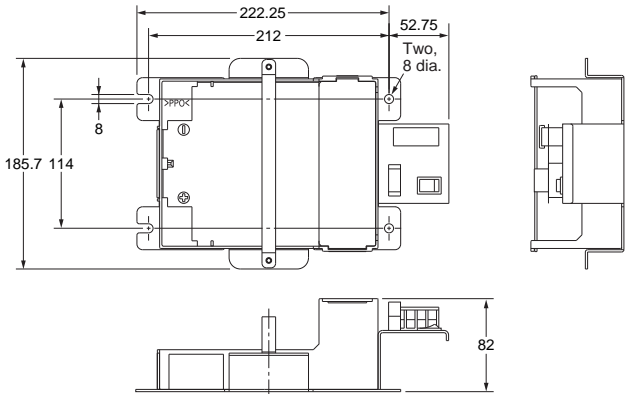

■ DIN Rail (Order Separately)

Note: All units are in millimeters unless otherwise indicated.

Mounting Rail (Material: Aluminum)

PFP-100N
PFP-50N

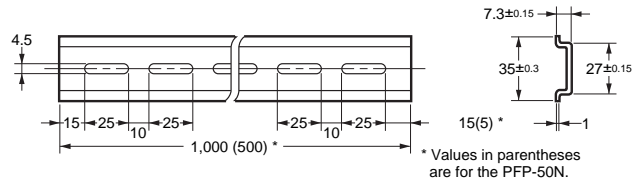
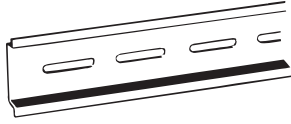

Mounting Rail (Material: Aluminum)

PFP-100N2

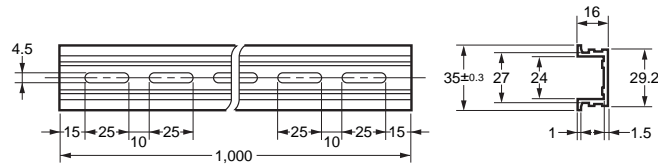
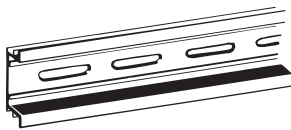

End Plate

PFP-M

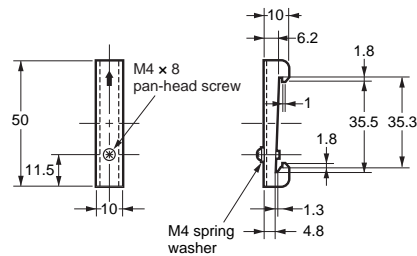

Safety Precautions

Refer to *Safety Precautions for All Power Supplies*.

WARNING

Application

Do not use the Product in applications in which there is a possibility of loss of life or bodily harm, such as with medical devices, or other devices that may significantly affect the public or society.



CAUTION

Application

This Product is intended for short-term backup in applications for which AC power is constantly supplied. Follow the procedure described in *Battery Overdischarge* on page 4 if the AC power is turned OFF or the power failure lasts for a number of hours. The service life of the battery will be considerably reduced, which may render recharging and backup impossible.



Battery Overdischarge

Follow the procedure described in *Battery Overdischarge* on page 4 to prevent battery overdischarge. If the battery is overdischarged, service life of the battery will be considerably reduced, which may render recharging and backup impossible.



Installation and Environment

The battery may generate flammable gases when it is charged, so that fire or explosion may be caused. Do not use the battery in a tight area or near an object that generates sparks, such as contactors, relays, or static charge.



Loose screws may cause fire. Tighten the terminal screws with torque of 1.08 N·m and tighten the connector screw and threaded flange with torque 0.20 N·m.



Loose screws may result in fire. The tightening torque for terminal screws on the Battery Holder is 0.74 N·m.



Electric shock may be caused. Do not remove any connector covers from a connector unless using Bus line connectors.



When connecting the Basic Block and DC Backup Block, lock the slider and rail stopper. If they are locked insufficiently, linkage may be disconnected due to vibration, causing electric shock.



Insufficient charge, overdischarge, or faulty operation of overload protection during backup operation switching will considerably reduce the service life of the battery, which may render backup impossible. Do not connect a load or capacitor between the S8T-DCBU-01 and the battery.



If a battery other than the designated ones is used, ignition and fire may be caused. Do not use batteries other than the designated ones.



Cracks will generate in the battery to cause leakage of electrolyte. Do not apply resin including a migrational plasticizer on the battery.



A short circuit may cause heat or spark, possibly causing a damage to battery, fire or explosion. When using metallic tools to install the battery to the Battery Holder, use one insulated with vinyl tape or the like.



Wrong connection may cause smoke or fire. Connect the battery correctly.



Install and ship the Battery Holder in the specified direction. Installing or shipping the Battery Holder in a non-specified direction may cause the battery fluid to leak. Protection against battery liquid leaking will not be possible, and the battery may produce smoke or may ignite.



The battery may deteriorate quickly and cause fire. (Operating temperature range of a battery: 0 to 40°C) Do not operate the battery in an area exceeding 40°C.



Do not use the Product in locations subject to corrosive gases. If the Product is used or left in atmospheres with corrosive gas, the corroded contact surfaces of the switches or relays may cause contact instability or contact failure and render battery recharging or backup operation impossible. In the worst case, corrosive gas entering the battery may cause fire.



Smoke and fire may be caused. Do not use new and old, different types, and different residual capacities of batteries mixed.



Internal parts may be deteriorated or damaged if the Product is used for applications with frequent inrush current at the load end. Do not use the Product for such applications.



Operation

A battery could be dangerous if it is used incorrectly. Follow the precautions of a battery when using.



Minor burns may occur due to high temperatures. Do not touch the Product while power is being supplied or immediately after power is turned OFF.



Electric shock may be caused. Do not add or separate the DC Backup Block during power-on.



If the equipment must be stopped in an emergency, turn OFF the AC power and disconnect the battery. If only the AC power is turned OFF, power will be supplied from the battery and the connected equipment will continue to operate. This may result in damage to equipment or injury.



Fire may be caused if the fully drained battery is kept in use. Replace the battery immediately if it is fully drained.



If malodor, abnormal noise, smoke, or fluid is issued from the battery, turn off the switch of the Battery Holder. Continuation of operation in this state may cause fire.



Battery fluid may cause loss of sight or burn injuries. Do not touch any fluid leaking from the battery. If the fluid comes into contact with your eyes or skin, immediately flush the area thoroughly with clean water and get medical attention.



Shocks or vibrations may cause battery performance to deteriorate. Do not use the Battery Holder in locations subject to shocks or vibrations.



Maintenance

Electric shock may be caused. Do not disassemble the Product or touch internal parts during power-on.







When performing maintenance, disconnect the battery before turning OFF the AC power. (Refer to *Battery Overdischarge* on page 4.) If only the AC power is turned OFF, power will be supplied from the battery and the connected equipment will continue to operate.



A dropping battery may cause injuries and burns caused by leaking electrolyte. Do not drop the battery during installation of the battery or Battery Holder or replacement of the battery.



- Sparks generated when the battery is connected may cause explosion or fire. Do not install or replace the battery in the presence of flammable gases. 
- Diluted sulfuric acid may leak, possibly causing loss of sight or burns. Do not disassemble or remodel the battery. 
- Electric shock, fire or burns may be caused. Do not short-circuit the battery using a metallic matter. 
- Explosion may be caused if a battery is thrown in fire. Observe self-imposed controls, laws and regulations for disposal or collection (recycle) of a battery. 

■ Precautions for Safe Use

Mounting

Ensure sufficient heat dissipation when installing the S8T-DCBU-01 to increase its long-term reliability. Natural cooling is used for the S8T-DCBU-01, so mount it so that there is airflow around it.

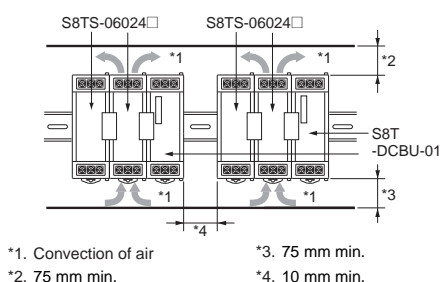

When cutting out holes for mounting, make sure that cuttings do not enter the interior of the products.

Be sure to remove the sheet covering the Power Supply for machining before turning ON the power so that it does not interfere with heat dissipation.

Connect the S8T-DCBU-01 to the right or left end of S8TS-06024 Basic Blocks.

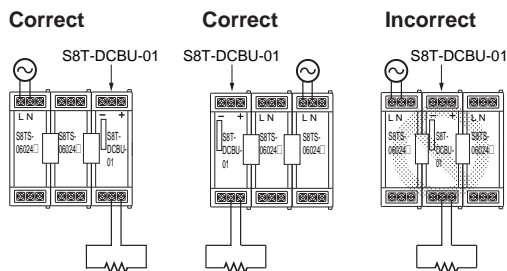

Wiring

During installation, make sure that the discharge voltage selector and the overload protection function selector are set correctly.

Minor fire may occur. Ensure that input and output terminals are wired correctly.

Connect the ground completely. Electric shock or malfunction may occur if the ground is not connected completely.

Do not apply more than 100-N force to the terminal block and connector terminal when tightening it.

Close the terminal cover to avoid short circuit of terminals with a foreign object.

Use the following material to wire to load and to the batteries for preventing wiring material from smoke or fire caused by the abnormal load.

Recommended Wire Diameter

| Overload protection operating point selector | Number of connected S8TS-06024 | Recommended wire diameter |
|--|--------------------------------|--|
| 5.7 A (typical) | 1, 2 | AWG 14 to 18 (cross-sectional area: 0.823 to 2.081 mm ²) |
| | 3 | AWG 14 to 16 (cross-sectional area: 1.309 to 2.081 mm ²) |
| 11.7 A (typical) | 3, 4, 5 | AWG 14 (cross-sectional area: 2.081 mm ²) |

Installation Environment

Do not use the Product in locations subject to shocks or vibrations. In particular, install the Product as far away as possible from contactors or other devices that are a vibration source. Be sure to mount End Plates (PFP-M) on both ends of the S8T-DCBU-01.

Install the S8T-DCBU-01 well away from any sources of strong, high-frequency noise and surge.

Ambient Operating and Storage Environment

Do not use or store the Product in the following locations. Doing so may result in product failure, incorrect operation, or deterioration.

- Usage in locations subject to direct sunlight
- Usage in locations with an ambient temperature outside the derating curve range
- Usage in locations with relative humidity outside 25% to 85% or condensation from rapid temperature change
- Storage in locations with an ambient temperature outside -25 to 65°C or relative humidity outside 25% to 90%
- Usage in locations where liquid, foreign matter, corrosive gas, or combustible gas may enter the product
- Follow the battery instructions regarding using the Battery Holder with the battery mounted and the storage environment.

When storing the battery for an extended period of time, observe the following two precautions.

- Turn OFF the battery switch. The standby current of the S8T-DCBU-01 will cause discharging to continue.
- Charge the battery at intervals specified by the manufacturer of the battery. Self-discharging during storage will cause battery to continue discharging.

Handling of Bus Line Connector

Do not drop or give strong impact on the Bus line connector.

DIN Rail Mounting

To mount the Block on a DIN rail, hook portion (A) of the Block onto the rail and press the Block in direction (B).

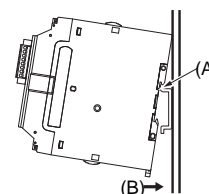

To dismount the Block, pull down portion (C) with a flat-blade screwdriver and pull out the Block.

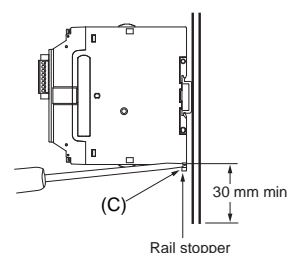

Troubleshooting

This page lists the errors that may occur when the S8T-DCBU-01 is used, along with their probable causes and remedies. Check the relevant item.

| When | Probable cause | Description | Remedies | |
|---|---|--|---|--|
| Installation | S8T-DCBU-01 cannot be connected. | The Bus Line Connector is provided with a selector for preventing misconnection of 5 V and 12 V specification of S8TS units. For this reason, connection is not successful if different specification units are installed. | Set the selector on the Bus Line Connector (provided) to 24 V. Refer to <i>S8T-BUS03</i> on page 7 for details. | |
| When checking the performances Refer to <i>Operation Check</i> on page 7 for details. | The S8T-DCBU-01 output indicator does not light in operation check procedure, step 2. | The S8T-DCBU-01 operates by the output of the S8TS-06024□. A probable cause is that the Bus Line Connector is not connected as the input voltage is connected by the Bus Line Connector (provided). | Connect the S8T-DCBU-01 to S8TS-06024□ using the Bus Line Connector (provided). Refer to <i>Basic Configuration</i> on page 2 for details. | |
| | The connected S8TS-06024□ does not operate in operation check procedure, step 2. | A probable cause is that the S8T-DCBU-01 is connected between S8TS-06024□ Basic Blocks. | The S8T-BUS03 Bus Line Connector for connecting the S8T-DCBU-01 is not connected to the AC power line. Connect the S8T-DCBU-01 to the left or right end of S8TS-06024□ Basic Blocks. | |
| | The battery status indicator is lit even 10 seconds or more after the power is turned ON in operation check procedure, step 3. | A probable cause is that the battery was connected with the + and – polarities reversed. | | Connect the battery correctly. Refer to <i>Incorrect Battery Connection Protection</i> on page 8 for details. |
| | | A probable cause is that the battery voltage falls below about 22.5 V. (Battery self-discharging or the standby current of the S8T-DCBU-01 may have caused discharging to continue.) | | Check the battery connection terminal voltage. If it is 18.5 V or lower, replace the battery. Subsequently, follow the procedure described in <i>Battery Overdischarge</i> on page 4. |
| | | A probable cause is that the backup ON/OFF input is open. | | Short the backup ON/OFF input. (At shipment, the backup ON/OFF input is shorted.) Refer to <i>Backup ON/OFF Input Function</i> on page 8 for details. |
| | | A probable cause is that the overload protection has been triggered in the connected S8TS-06024□. | | As energy is consumed by S8T-DCBU-01, the total output capacity of the number of connected S8TS-06024□s cannot be obtained. Connect one more S8TS-06024□ Basic Block. Refer to the <i>Derating Curve</i> on page 11 for details. |
| | | A probable cause is that the overload protection function selector switch on the S8T-DCBU-01 is set low. | | When three or more S8TS-06024□ Basic Blocks are connected, set the overload protection function selector to 11.7 A (typical). (The default setting is 5.7 A (typical).) Refer to <i>Overload Protection Operating Point Selector</i> on page 8 for details. |
| | A probable cause is that the output voltage adjuster (V. ADJ) of the connected S8TS-06024□ is set lower than the factory-set voltage. | | The S8T-DCBU-01 detects drops in the output voltage of the S8TS-06024□ and switches over to backup operation. Adjust the output voltage adjuster (V. ADJ) on the S8TS-06024□ so that the output in a no-load state is 24.5 V or more. Refer to <i>Output Voltage Adjustment for S8TS-06024□</i> on page 6 for details. | |
| The backup operation is not performed in operation check procedure, step 5. | A probable cause is that inrush current during backup operation caused the fuse on the battery to blow. | | Select a fuse taking the inrush current when backup operation is switched to into consideration. The recommended S82Y-TS01 Battery Holder is selected taking this inrush current into consideration. Refer to <i>Battery Holder S82Y-TS01</i> on page 6 for details. | |
| When S8T-DCBU-01 is used | The backup state is not returned to normal even after the power is restored from a power failure. | A probable cause is that a protection function on the S8TS-06024□ was activated to stop S8TS-06024□ operation. | Cancel the protection functions on the S8TS-06024□. (Turn OFF the power of S8TS-06024□ Basic Block, and after at least one minute turn ON the input voltage again.) | |
| | Output was cut during backup operation. | A probable cause is that the overdischarge protection function was activated by a battery voltage dropping due to discharge. | If a remedy is required during backup operation, allow backup to finish until the battery status indicator is lit. | |
| | | A probable cause is that an overload state is reached due to load fluctuations during backup operation. | Provide sufficient margin for the load capacity when using the S8T-DCBU-01. | |
| | Backup operation and normal operation are alternately repeated. | A probable cause is that one of the S8TS-06024□s is out of order when two or more S8TS-06024□s are connected. | Replace the out-of-order S8TS-06024□. Refer to <i>Backup Function</i> on page 6 for details. | |
| | | A probable cause is that the S8TS-06024□ is in an overload state due to load fluctuations during normal operation. | Provide sufficient margin for the load capacity when using the S8T-DCBU-01. | |
| The battery status indicator remains lit when a period of 24 hours has passed after power has been applied. | A probable cause is that discharging continued while the AC was turned OFF because of battery self-discharging or standby current of the S8T-DCBU-01. | Replace the battery. Subsequently, follow the procedure described in <i>Battery Overdischarge</i> on page 4. | | |

| When | Probable cause | Description | Remedies |
|---------------------------|--|--|---|
| When inspecting batteries | Backup time is too short. | A probable cause is that backup operation was performed frequently (e.g., turning OFF the AC power at night or on days off). | Replace the battery. Subsequently, follow the procedure described in <i>Battery Overdischarge</i> on page 4. |
| | | A probable cause is that the battery has reached the end of its service life. | We recommend periodically replacing the battery. Refer to <i>Battery Replacement</i> on page 9 for details. |
| | | A probable cause is that the S8T-DCBU-01 was stored for a long time with the battery connected. | Replace the battery. Subsequently, follow the procedure described in <i>Battery Overdischarge</i> on page 4. |
| | | A probable cause is that battery characteristics caused the backup time to shorten in low temperatures. | Check the backup time in the operating environment before use. |
| | The voltages of the two batteries used in series are considerably different. | A probable cause is a battery abnormality. | Replace both batteries. |

ALL DIMENSIONS SHOWN ARE IN MILLIMETERS.

To convert millimeters into inches, multiply by 0.03937. To convert grams into ounces, multiply by 0.03527.

In the interest of product improvement, specifications are subject to change without notice.

Terms and Conditions Agreement

Read and understand this catalog.

Please read and understand this catalog before purchasing the products. Please consult your OMRON representative if you have any questions or comments.

Warranties.

(a) Exclusive Warranty. Omron's exclusive warranty is that the Products will be free from defects in materials and workmanship for a period of twelve months from the date of sale by Omron (or such other period expressed in writing by Omron). Omron disclaims all other warranties, express or implied.

(b) Limitations. OMRON MAKES NO WARRANTY OR REPRESENTATION, EXPRESS OR IMPLIED, ABOUT NON-INFRINGEMENT, MERCHANTABILITY OR FITNESS FOR A PARTICULAR PURPOSE OF THE PRODUCTS. BUYER ACKNOWLEDGES THAT IT ALONE HAS DETERMINED THAT THE PRODUCTS WILL SUITABLY MEET THE REQUIREMENTS OF THEIR INTENDED USE.

Omron further disclaims all warranties and responsibility of any type for claims or expenses based on infringement by the Products or otherwise of any intellectual property right. (c) Buyer Remedy. Omron's sole obligation hereunder shall be, at Omron's election, to (i) replace (in the form originally shipped with Buyer responsible for labor charges for removal or replacement thereof) the non-complying Product, (ii) repair the non-complying Product, or (iii) repay or credit Buyer an amount equal to the purchase price of the non-complying Product; provided that in no event shall Omron be responsible for warranty, repair, indemnity or any other claims or expenses regarding the Products unless Omron's analysis confirms that the Products were properly handled, stored, installed and maintained and not subject to contamination, abuse, misuse or inappropriate modification. Return of any Products by Buyer must be approved in writing by Omron before shipment. Omron Companies shall not be liable for the suitability or unsuitability or the results from the use of Products in combination with any electrical or electronic components, circuits, system assemblies or any other materials or substances or environments. Any advice, recommendations or information given orally or in writing, are not to be construed as an amendment or addition to the above warranty.

See <http://www.omron.com/global/> or contact your Omron representative for published information.

Limitation on Liability; Etc.

OMRON COMPANIES SHALL NOT BE LIABLE FOR SPECIAL, INDIRECT, INCIDENTAL, OR CONSEQUENTIAL DAMAGES, LOSS OF PROFITS OR PRODUCTION OR COMMERCIAL LOSS IN ANY WAY CONNECTED WITH THE PRODUCTS, WHETHER SUCH CLAIM IS BASED IN CONTRACT, WARRANTY, NEGLIGENCE OR STRICT LIABILITY.

Further, in no event shall liability of Omron Companies exceed the individual price of the Product on which liability is asserted.

Suitability of Use.

Omron Companies shall not be responsible for conformity with any standards, codes or regulations which apply to the combination of the Product in the Buyer's application or use of the Product. At Buyer's request, Omron will provide applicable third party certification documents identifying ratings and limitations of use which apply to the Product. This information by itself is not sufficient for a complete determination of the suitability of the Product in combination with the end product, machine, system, or other application or use. Buyer shall be solely responsible for determining appropriateness of the particular Product with respect to Buyer's application, product or system. Buyer shall take application responsibility in all cases.

NEVER USE THE PRODUCT FOR AN APPLICATION INVOLVING SERIOUS RISK TO LIFE OR PROPERTY OR IN LARGE QUANTITIES WITHOUT ENSURING THAT THE SYSTEM AS A WHOLE HAS BEEN DESIGNED TO ADDRESS THE RISKS, AND THAT THE OMRON PRODUCT(S) IS PROPERLY RATED AND INSTALLED FOR THE INTENDED USE WITHIN THE OVERALL EQUIPMENT OR SYSTEM.

Programmable Products.

Omron Companies shall not be responsible for the user's programming of a programmable Product, or any consequence thereof.

Performance Data.

Data presented in Omron Company websites, catalogs and other materials is provided as a guide for the user in determining suitability and does not constitute a warranty. It may represent the result of Omron's test conditions, and the user must correlate it to actual application requirements. Actual performance is subject to the Omron's Warranty and Limitations of Liability.

Change in Specifications.

Product specifications and accessories may be changed at any time based on improvements and other reasons. It is our practice to change part numbers when published ratings or features are changed, or when significant construction changes are made. However, some specifications of the Product may be changed without any notice. When in doubt, special part numbers may be assigned to fix or establish key specifications for your application. Please consult with your Omron's representative at any time to confirm actual specifications of purchased Product.

Errors and Omissions.

Information presented by Omron Companies has been checked and is believed to be accurate; however, no responsibility is assumed for clerical, typographical or proofreading errors or omissions.

2013.11

In the interest of product improvement, specifications are subject to change without notice.

OMRON Corporation
Industrial Automation Company

<http://www.ia.omron.com/>

(c)Copyright OMRON Corporation 2013 All Right Reserved.

Mouser Electronics

Authorized Distributor

Click to View Pricing, Inventory, Delivery & Lifecycle Information:

[Omron:](#)

[S8T-DCBU-01](#)

Данный компонент на территории Российской Федерации

Вы можете приобрести в компании MosChip.

Для оперативного оформления запроса Вам необходимо перейти по данной ссылке:

<http://moschip.ru/get-element>

Вы можете разместить у нас заказ для любого Вашего проекта, будь то серийное производство или разработка единичного прибора.

В нашем ассортименте представлены ведущие мировые производители активных и пассивных электронных компонентов.

Нашей специализацией является поставка электронной компонентной базы двойного назначения, продукции таких производителей как XILINX, Intel (ex.ALTERA), Vicor, Microchip, Texas Instruments, Analog Devices, Mini-Circuits, Amphenol, Glenair.

Сотрудничество с глобальными дистрибьюторами электронных компонентов, предоставляет возможность заказывать и получать с международных складов практически любой перечень компонентов в оптимальные для Вас сроки.

На всех этапах разработки и производства наши партнеры могут получить квалифицированную поддержку опытных инженеров.

Система менеджмента качества компании отвечает требованиям в соответствии с ГОСТ Р ИСО 9001, ГОСТ РВ 0015-002 и ЭС РД 009

Офис по работе с юридическими лицами:

105318, г.Москва, ул.Щербаковская д.3, офис 1107, 1118, ДЦ «Щербаковский»

Телефон: +7 495 668-12-70 (многоканальный)

Факс: +7 495 668-12-70 (доб.304)

E-mail: info@moschip.ru

Skype отдела продаж:

moschip.ru

moschip.ru_4

moschip.ru_6

moschip.ru_9