



MIC3202/MIC3202-1

High-Brightness LED Driver with Integrated MOSFET and High-Side Current Sense

General Description

The MIC3202 is a hysteretic, step-down, constant-current, High-Brightness LED (HB LED) driver. It provides an ideal solution for interior/exterior lighting, architectural and ambient lighting, LED bulbs, and other general illumination applications.

The MIC3202 is well suited for lighting applications requiring a wide-input voltage range. The hysteretic control gives good supply rejection and fast response during load transients and PWM dimming. The high-side current sensing and on-chip current-sense amplifier delivers LED current with $\pm 5\%$ accuracy. An external high-side current-sense resistor is used to set the output current.

The MIC3202 offers a dedicated PWM input (DIM) which enables a wide range of pulsed dimming. High-frequency switching operation of up to 1MHz allows the use of smaller external components, minimizing space and cost. The MIC3202 offers a frequency dither feature for low-EMI applications.

The MIC3202 operates over a junction temperature from -40°C to $+125^{\circ}\text{C}$ and is available in an 8-pin e-PAD SOIC package.

A dither disabled version MIC3202-1 is also available in the same package as the MIC3202.

Datasheets and support documentation can be found on Micrel's web site at: www.micrel.com.

Features

- 6V to 37V input voltage range
- High efficiency ($>90\%$)
- $\pm 5\%$ LED current accuracy
- MIC3202: Dither enabled for low EMI
- MIC3202-1: Dither disabled
- High-side current sense (up to 1A)
- Dedicated dimming control input
- Hysteretic control (no compensation required)
- Up to 1MHz switching frequency
- Adjustable constant LED current
- Over-temperature protection
- -40°C to $+125^{\circ}\text{C}$ junction temperature range

Applications

- Architectural, industrial, and ambient lighting
- LED bulbs
- Indicators and emergency lighting
- Street lighting
- Channel letters
- 12V lighting systems (MR-16 bulbs, under-cabinet lighting, garden/pathway lighting)

Typical Application

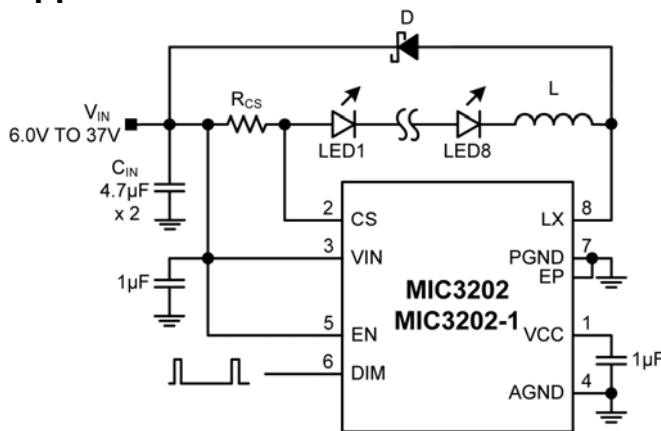

MIC3202 Step-Down LED Driver

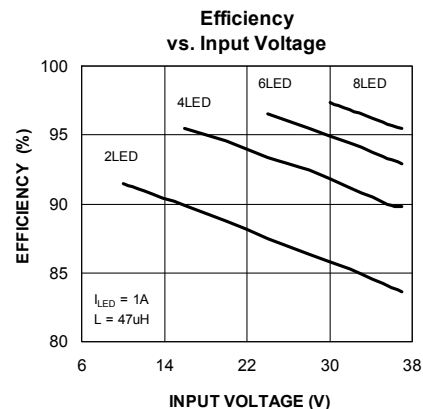

Ordering Information ⁽¹⁾

| Part Number | Marking | Junction Temperature Range | Package | PWM |
|--------------|--------------|----------------------------|------------|------------|
| MIC3202YME | MIC3202YME | -40°C to +125°C | 8-Pin SOIC | Dither |
| MIC3202-1YME | MIC3202-1YME | -40°C to +125°C | 8-Pin SOIC | Non-Dither |

Note:

1. YM[®] is a GREEN RoHS-compliant package. Lead finish is NiPdAu. Mold compound is Halogen Free.

Pin Configuration

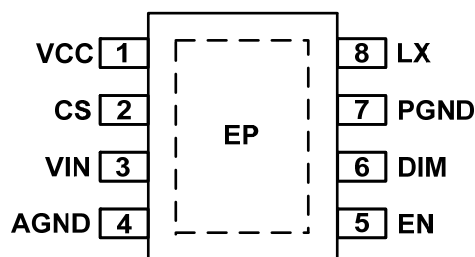

8-Pin ePAD SOIC
MIC3202/MIC3202-1

Pin Description

| Pin Number | Pin Name | Pin Function |
|------------|----------|---|
| 1 | VCC | Voltage Regulator Output. The VCC pin supplies the power to the internal circuitry. The VCC is the output of a linear regulator which is powered from VIN. A 1µF ceramic capacitor is recommended for bypassing and should be placed as close as possible to the VCC and AGND pins. |
| 2 | CS | Current-Sense Input. The CS pin provides the high-side current sense to set the LED current using an external sense resistor. |
| 3 | VIN | Input Power Supply. The VIN pin is the input supply pin to the internal circuitry and the positive input to the current sense comparator. Due to the high frequency switching noise, a 1µF ceramic capacitor is recommended to be placed as close as possible to VIN pin and the power ground (PGND) pin for bypassing. Please refer to layout recommendations. |
| 4 | AGND | Ground pin for analog circuitry. Internal signal ground for all low power sections. |
| 5 | EN | Enable Input. The EN pin provides a logic level control of the output. The voltage has to be 2.0V or higher to enable the current regulator. The output stage is also gated by the DIM input. When the EN pin is pulled low, the regulator goes to off state and the supply current of the device is greatly reduced (below 1µA). |
| 6 | DIM | PWM Dimming Input. The DIM pin provides the control for brightness of the LED. A PWM input can be used to control the brightness of LED. DIM high enables the output and its voltage has to be at least 2.0V or higher. DIM low disables the output, regardless of EN "high" state. |
| 7 | PGND | Power Ground pin for Internal Power FET. Power Ground (PGND) is the ground path for the high current. The current loop for the power ground should be as small as possible and separate from the Analog ground (AGND) loop. Refer to the layout considerations for more details. |
| 8 | LX | Drain of Internal Power MOSFET. The LX pin connects directly to the inductor and provides the switching current necessary to operate in hysteretic mode. Due to the high frequency switching and high voltage associated with this pin, the switch node should be routed away from sensitive nodes. |
| EP | GND | Connect to PGND. |

Absolute Maximum Ratings ^(1, 2)

| | |
|-------------------------------------|------------------------------|
| V_{IN} to PGND | -0.3V to +42V |
| V_{LX} to PGND | -0.3V to ($V_{IN} + 0.6V$) |
| V_{CS} to PGND | -0.3V to ($V_{IN} + 0.3V$) |
| V_{EN} to AGND | -0.3V to ($V_{IN} + 0.3V$) |
| V_{DIM} to AGND | -0.3V to ($V_{IN} + 0.3V$) |
| V_{CC} to PGND | -0.3V to +6.0V |
| PGND to AGND | -0.3V to +0.3V |
| Junction Temperature | 150°C |
| Storage Temperature Range | -60°C to +150°C |
| Lead Temperature (Soldering, 10sec) | 260°C |

Operating Ratings ⁽³⁾

| | |
|--------------------------------|-----------------|
| Supply Voltage (V_{IN}) | 6.0V to 37V |
| Enable Voltage (V_{EN}) | 0V to V_{IN} |
| Dimming Voltage (V_{DIM}) | 0V to V_{IN} |
| Junction Temperature (T_J) | -40°C to +125°C |
| Junction Thermal Resistance | |
| SOIC (θ_{JA}) | 41°C/W |
| SOIC (θ_{JC}) | 14.7°C/W |

Electrical Characteristics ⁽⁴⁾

$V_{IN} = V_{EN} = V_{DIM} = 12V$; $C_{VCC} = 1.0\mu F$; $T_J = 25^\circ C$, **bold** values indicate $-40^\circ C \leq T_J \leq +125^\circ C$; unless noted.

| Symbol | Parameter | Condition | Min. | Typ. | Max. | Units |
|----------------------------|--|--|------------|----------|-------------|---------|
| Input Supply | | | | | | |
| V_{IN} | Input Voltage Range (V_{IN}) | | 6.0 | | 37.0 | V |
| I_S | Supply Current | LX Pin = open | | 1.2 | 1.75 | mA |
| I_{SD} | Shut Down Current | $V_{EN} = 0V$; $T_J =$ from $-40^\circ C$ to $85^\circ C$ | | 0.05 | 5 | μA |
| UVLO | V_{IN} UVLO Threshold | V_{IN} Rinsing | 3.2 | 4 | 4.5 | V |
| UVLO _{HYS} | V_{IN} UVLO Hysteresis | | | 500 | | mV |
| VCC Supply | | | | | | |
| VCC | V_{CC} Output Voltage | $V_{CS} = V_{IN} = 12V$, $I_{CC} = 10mA$ | 4.5 | 5 | 5.5 | V |
| Current Limit | | | | | | |
| $V_{CS(MAX)}$ | Current-Sense Upper Threshold | $V_{CS(MAX)} = V_{IN} - V_{CS}$ | 199 | 212 | 225 | mV |
| $V_{CS(MIN)}$ | Current-Sense Lower Threshold | $V_{CS(MIN)} = V_{IN} - V_{CS}$ | 165 | 177 | 189 | mV |
| V_{CSHYS} | V_{CS} Hysteresis | | | 35 | | mV |
| | Current-Sense Response Time | V_{CS} Rising | | 60 | | ns |
| | | V_{CS} Falling | | 40 | | |
| | Current-Sense Input Current | $V_{IN} - V_{CS} = 200mV$ | | | 3 | μA |
| Frequency | | | | | | |
| F_{MAX} | Maximum Switching Frequency | | | | 1 | MHz |
| Dithering (MIC3202) | | | | | | |
| V_{DITH} | V_{CS} Hysteresis Dithering Range ⁽⁵⁾ | | | ± 6 | | mV |
| F_{DITHER} | Frequency Dithering Range ⁽⁵⁾ | % of Switching Frequency | | ± 12 | | % |
| Enable Input | | | | | | |
| EN_{HI} | EN Logic Level High | | 2.0 | | | V |
| EN_{LO} | EN Logic Level Low | | | | 0.4 | V |
| | EN Bias Current | $V_{EN} = 12V$ | | 30 | 60 | μA |
| | | $V_{EN} = 0V$ | | 0.1 | 1 | |
| | Start-up Time | From EN Pin going high to LX going low | | 30 | | μs |

Electrical Characteristics ⁽⁴⁾

$V_{IN} = V_{EN} = V_{DIM} = 12V$; $C_{VCC} = 1.0\mu F$; $T_J = 25^\circ C$, bold values indicate $-40^\circ C \leq T_J \leq +125^\circ C$; unless noted.

| Symbol | Parameter | Condition | Min. | Typ. | Max. | Units |
|---------------------------|--------------------------------------|---|------------|------|------------|------------|
| Dimming Input | | | | | | |
| DIM _{HI} | DIM Logic Level High | | 2.0 | | | V |
| DIM _{LO} | DIM Logic Level Low | | | | 0.4 | V |
| | DIM Bias Current | $V_{DIM} = 12V$ | | 20 | 35 | μA |
| $V_{DIM} = 0V$ | | | | 0.1 | 1 | |
| f _{DIM} | Maximum Dimming Frequency | | | | 20 | kHz |
| Internal MOSFET | | | | | | |
| R _{DS(ON)} | MOSFET R _{DS(ON)} | $I_{LX} = 200mA$ | | 275 | 625 | m Ω |
| | LX Leakage Current | $V_{EN} = 0V$; $V_{IN} = V_{LX} = 37V$ | | 5 | 50 | μA |
| Thermal Protection | | | | | | |
| T _{LIM} | Over-Temperature Shutdown | T _J Rising | | 160 | | $^\circ C$ |
| T _{LIMHYS} | Over-Temperature Shutdown Hysteresis | | | 20 | | |

Notes:

1. Exceeding the absolute maximum rating may damage the device.
2. Devices are ESD sensitive. Handling precautions recommended. Human body model, 1.5k in series with 100pF.
3. The device is not guaranteed to function outside its operating rating.
4. Specification for packaged product only.
5. Guaranteed by design.

Typical Characteristics

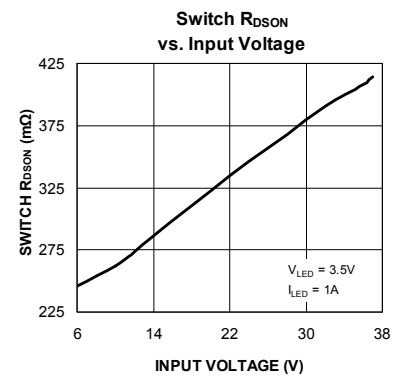
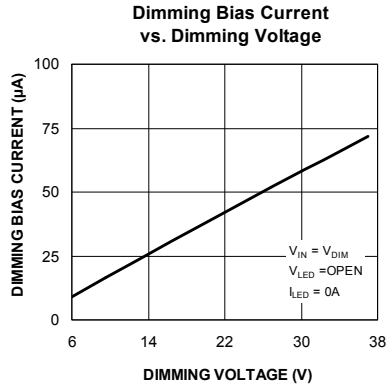
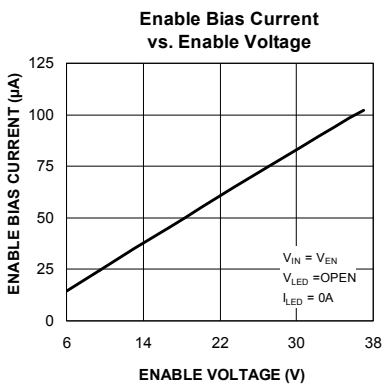
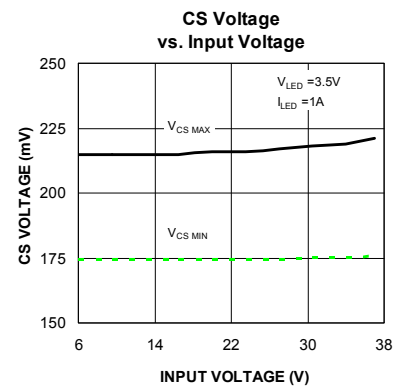
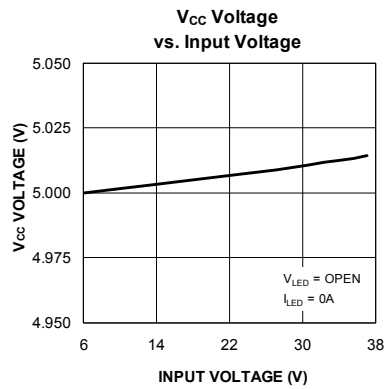
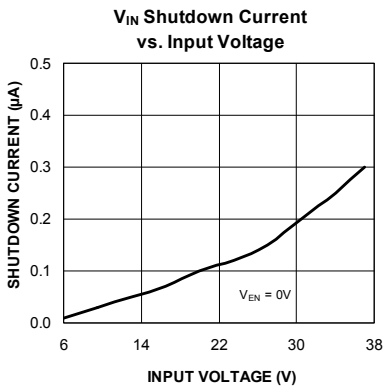
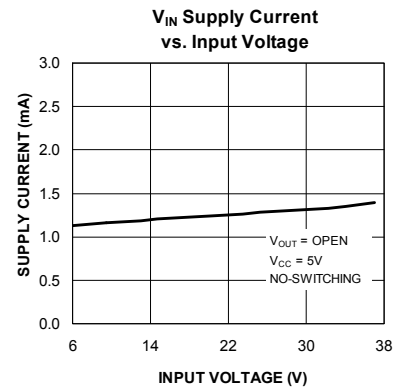
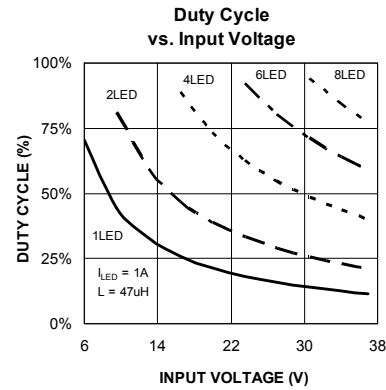
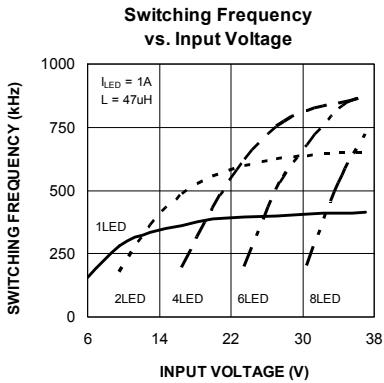
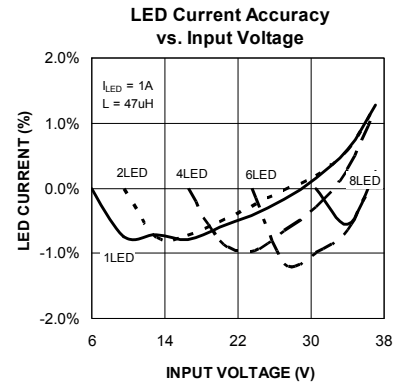
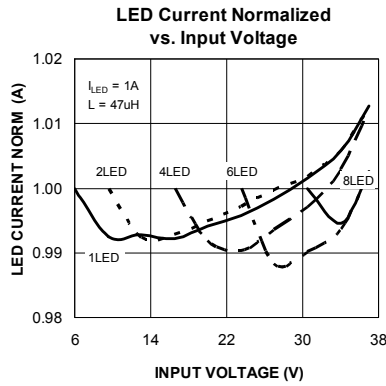
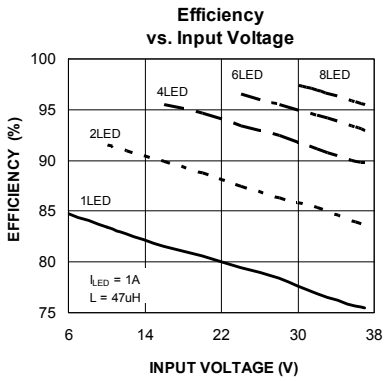

Typical Characteristics (Continued)

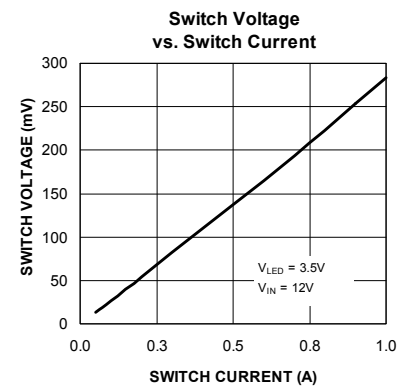
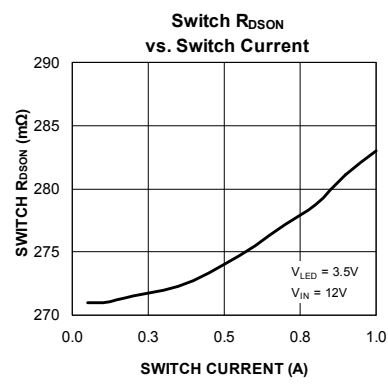
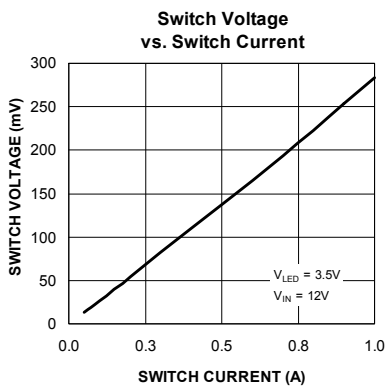
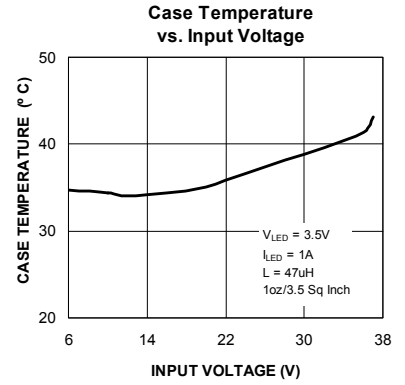
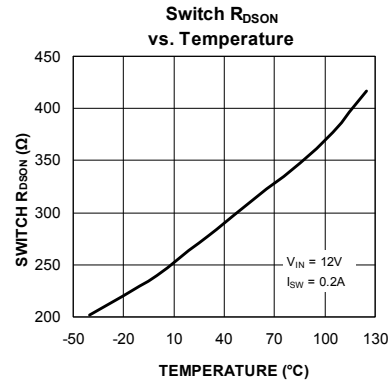
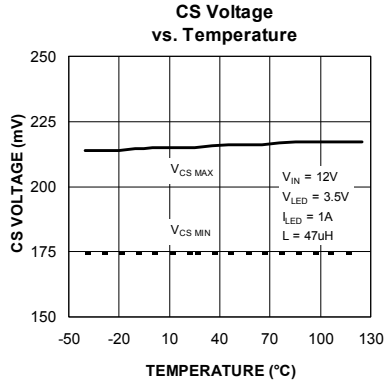
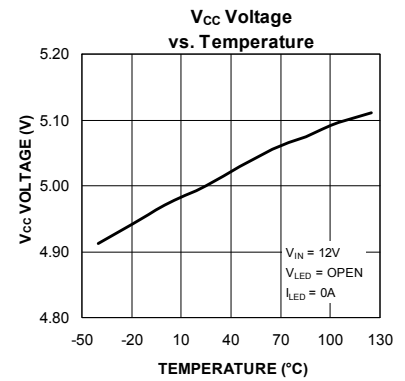
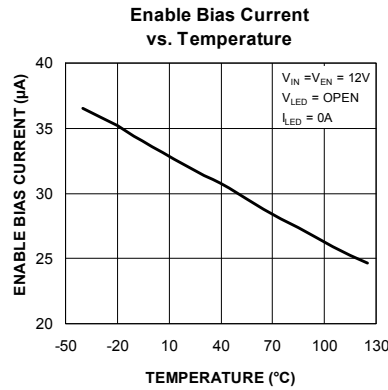
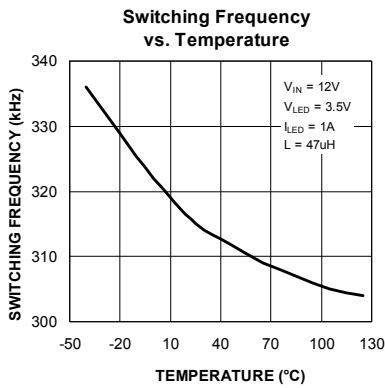
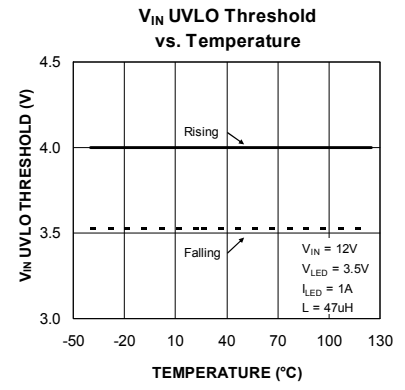
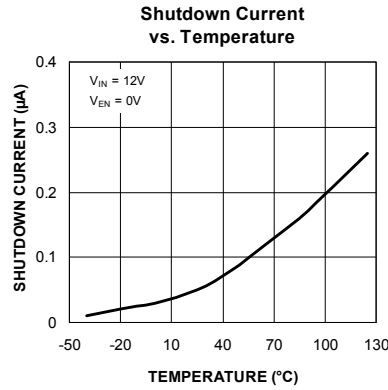
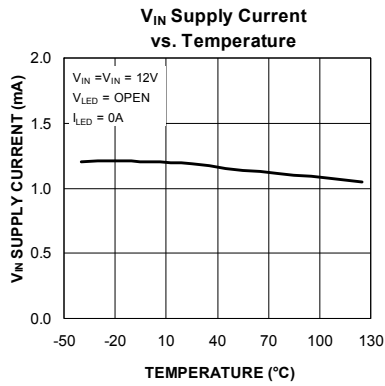

Functional Characteristics

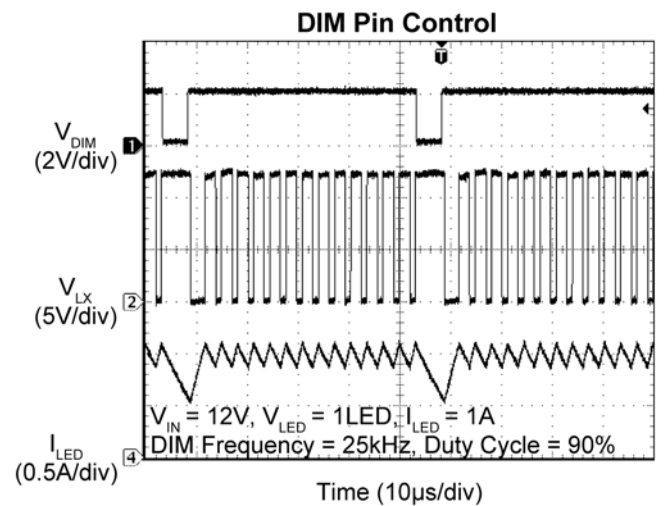
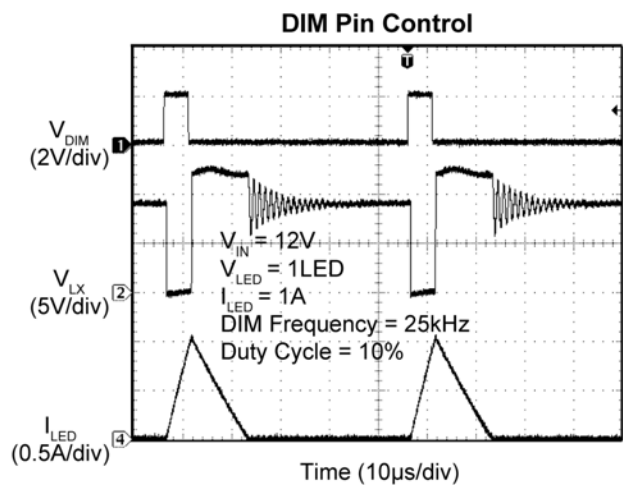
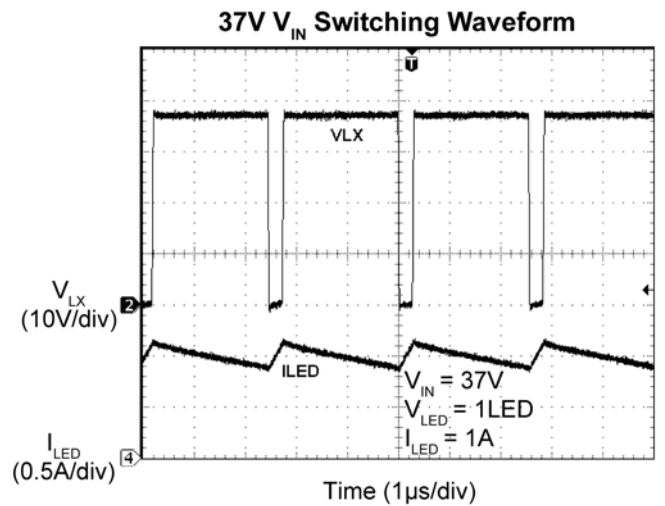
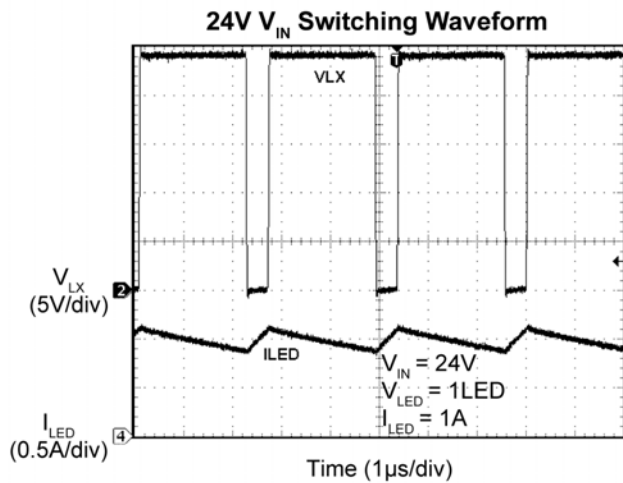
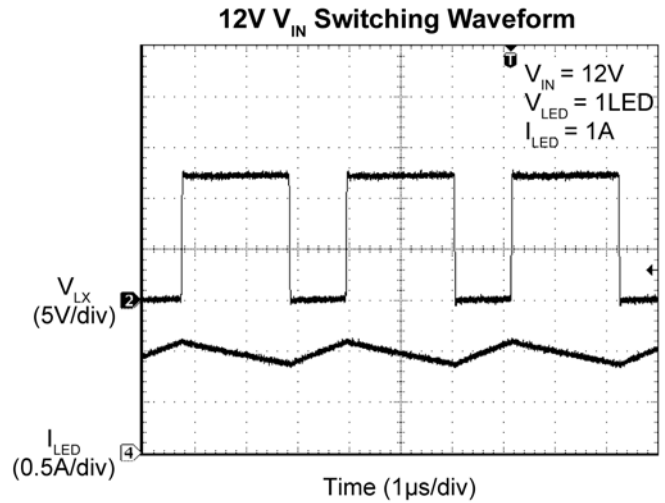
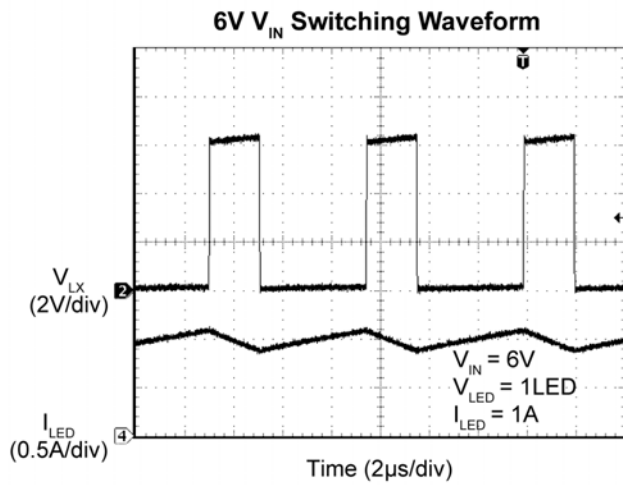

Functional Characteristics (Continued)

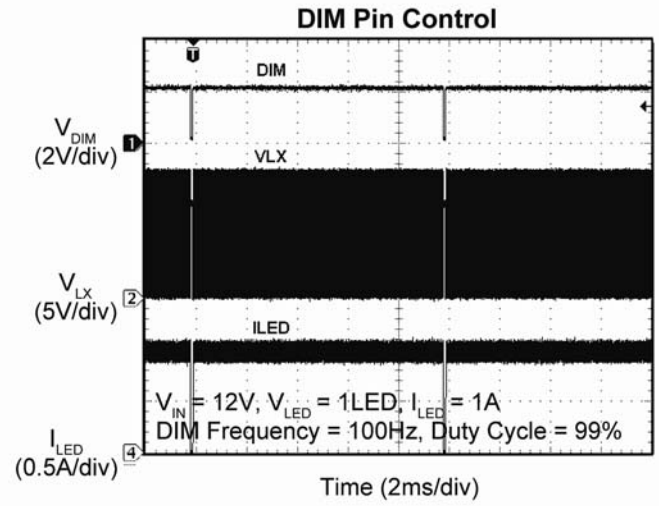
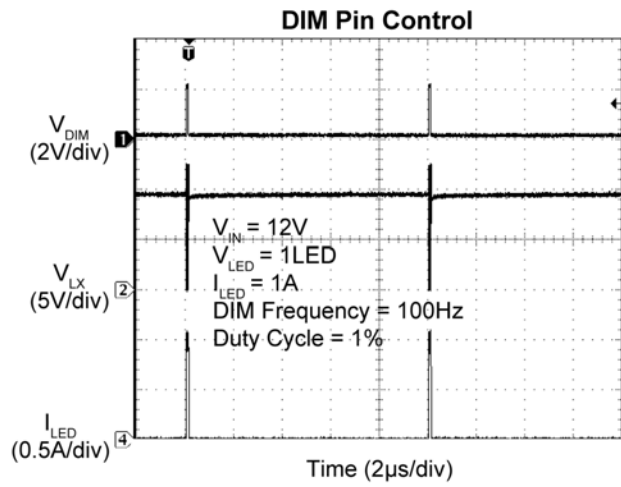

Functional Diagram

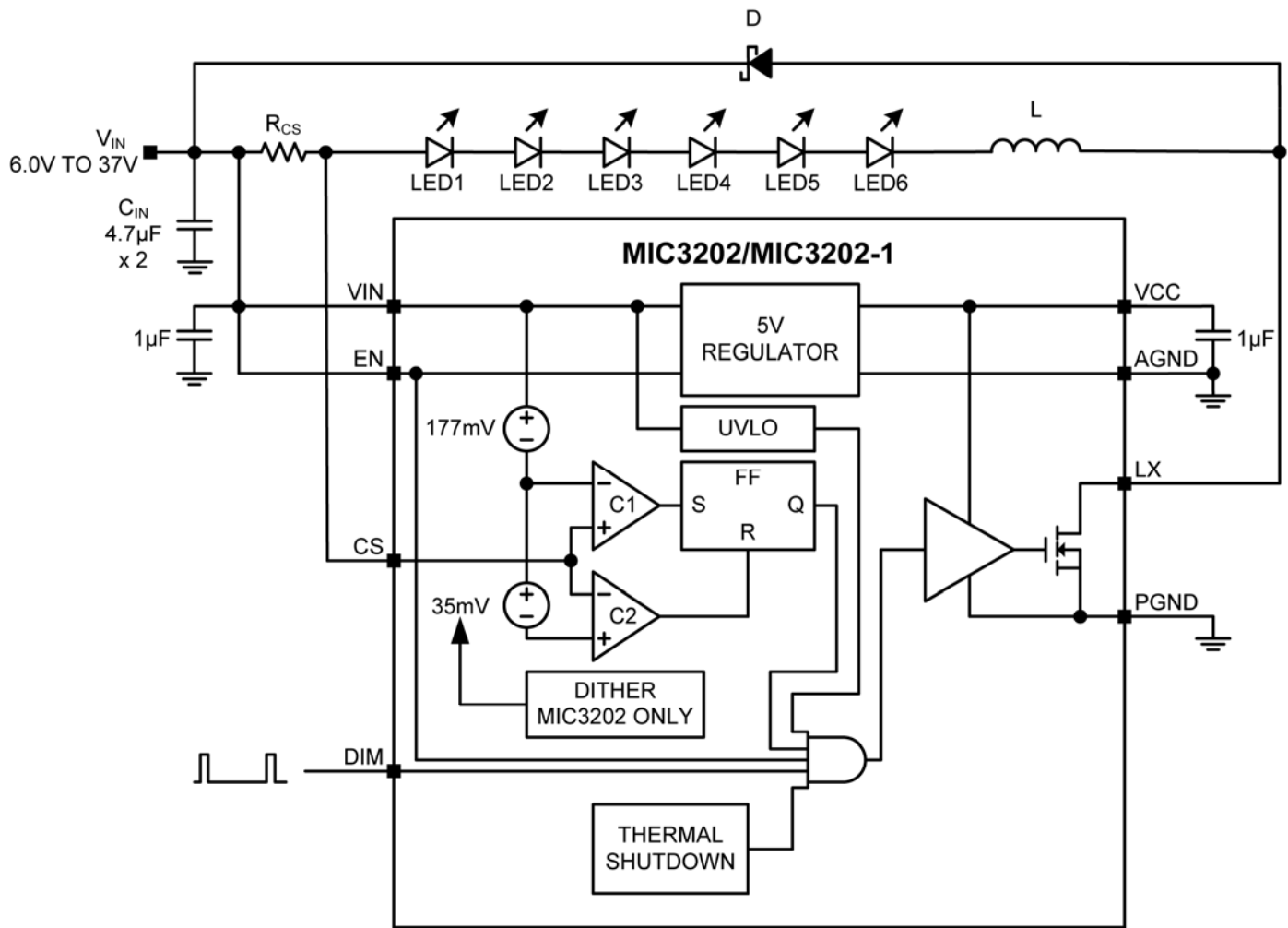

Figure 1. MIC3202/MIC3202-1 Functional Block Diagram

Functional Description

The MIC3202 is a hysteretic step-down driver which regulates the LED current over wide input voltage range and capable of driving up to eight 1A LEDs in series.

The device operates from a 6V to 37V input. When the input voltage reaches 6V, the internal 5V VCC is regulated and the LX pin is pulled low if the EN pin and DIM pin are high. The inductor current builds up linearly. When the CS pin voltage hits $V_{CS(MAX)}$ with respect to V_{IN} , the MOSFET turns off and the Schottky diode takes over and returns the current to V_{IN} . Then the current through inductor and LEDs starts decreasing. When CS pin hits $V_{CS(MIN)}$, the MOSFET turns on and the cycle repeats.

The frequency of operation depends upon the input voltage, total LED voltage drop, LED current and temperature. The calculation for frequency of operation is given in the *Application Information* section.

The MIC3202 has an EN pin which gives the flexibility to enable and disable the output with logic high and low signals.

The MIC3202 also has a DIM pin which can turn on and off the LEDs if EN is in HIGH state. This DIM pin controls the brightness of the LED by varying the duty cycle of DIM pin from 1% to 99%.

Application Information

The internal block diagram of the MIC3202 is shown in Figure 1. The MIC3202 is composed of a current-sense comparator, voltage and current reference, 5V regulator and MOSFET. Hysteretic mode control, also called bang-bang control, is a topology that does not employ an error amplifier, using an error comparator instead.

The inductor current is controlled within a hysteretic window. If the inductor current is too small, the power MOSFET is turned on; if the inductor current is large enough, the power MOSFET is turned off. It is a simple control scheme with no oscillator and no loop compensation. Since the control scheme does not need loop compensation, it simplifies design and avoids problems of instability.

Transient response to load and line variation is very fast and only depends on propagation delay. This makes the control scheme very popular to achieve low dimming duty cycles.

LED Current and R_{CS}

The main function of the MIC3202 is to control the LED current accurately within $\pm 5\%$ of the set current. A high-side R_{CS} resistor sets LED current. The following equation gives the R_{CS} value:

$$R_{CS} = \frac{1}{2} \times \left(\frac{V_{CS(MAX)} + V_{CS(MIN)}}{I_{LED}} \right)$$

| R_{CS} (Ω) | I_{LED} (A) | I^2R (W) | Size (SMD) |
|-----------------------|---------------|------------|------------|
| 1.33 | 0.15 | 0.03 | 0603 |
| 0.56 | 0.35 | 0.07 | 0805 |
| 0.4 | 0.5 | 0.1 | 0805 |
| 0.28 | 0.7 | 0.137 | 0805 |
| 0.2 | 1.0 | 0.2 | 1206 |

Table 1. R_{CS} Values for Various LED Currents

For $V_{CS(MAX)}$ and $V_{CS(MIN)}$, refer to the Electrical Characteristic table.

Frequency of Operation

To calculate the frequency spread across input supply:

$$V_L = L \frac{\Delta I_L}{\Delta t}$$

L is the inductance, ΔI_L is fixed (the value of the hysteresis):

$$\Delta I_L = \frac{V_{CS(MAX)} - V_{CS(MIN)}}{R_{CS}}$$

V_L is the voltage across inductor L which varies by supply.

For current rising (MOSFET is ON):

$$t_r = L \frac{\Delta I_L}{V_{L_RISE}}$$

where:

$$V_{L_RISE} = V_{IN} - I_{LED} \times R_{CS} - V_{LED}$$

For current falling (MOSFET is OFF):

$$t_f = L \frac{\Delta I_L}{V_{L_FALL}}$$

where:

$$V_{L_FALL} = V_D + I_{LED} \times R_{CS} + V_{LED}$$

$$T = t_r + t_f, f_{SW} = \frac{1}{T}$$

$$f_{SW} = \frac{(V_D + I_{LED} \times R_{CS} + V_{LED}) \times (V_{IN} - I_{LED} \times R_{CS} - V_{LED})}{L \times \Delta I_L \times (V_D + V_{IN})}$$

where:

V_D is Schottky diode forward drop.

V_{LED} is total LEDs voltage drop.

V_{IN} is input voltage.

I_{LED} is average LED current.

Inductor

According to the above equation, choose the inductor to make the operating frequency no higher than 1.0MHz. Tables 2, 3, and 4 give a reference inductor value and corresponding frequency for a given LED current. For space-sensitive applications, smaller inductor with higher switching frequency could be used but the efficiency of the regular will be reduced.

| RCS (Ω) | I _{LED} (A) | L (μH) | F _{SW} (kHz) |
|---------|----------------------|--------|-----------------------|
| 1.33 | 0.15 | 220 | 474 |
| 0.56 | 0.35 | 100 | 439 |
| 0.4 | 0.5 | 68 | 461 |
| 0.28 | 0.7 | 47 | 467 |
| 0.2 | 1.0 | 33 | 475 |

Table 2. Inductor for V_{IN} = 12V, 1 LED

| RCS (Ω) | I _{LED} (A) | L (μH) | F _{SW} (kHz) |
|---------|----------------------|--------|-----------------------|
| 1.33 | 0.15 | 470 | 474 |
| 0.56 | 0.35 | 220 | 426 |
| 0.4 | 0.5 | 150 | 447 |
| 0.28 | 0.7 | 100 | 470 |
| 0.2 | 1.0 | 68 | 493 |

Table 3. Inductor for V_{IN} = 24V, 4 LEDs

| RCS (Ω) | I _{LED} (A) | L (μH) | F _{SW} (kHz) |
|---------|----------------------|--------|-----------------------|
| 1.33 | 0.15 | 470 | 495 |
| 0.56 | 0.35 | 220 | 446 |
| 0.4 | 0.5 | 150 | 467 |
| 0.28 | 0.7 | 100 | 490 |
| 0.2 | 1.0 | 68 | 515 |

Table 4. Inductor for V_{IN} = 36V, 8 LEDs

Given an inductor value, the size of the inductor can be determined by its RMS and peak current rating.

$$\frac{\Delta I_L}{I_L} = 2 \times \frac{V_{CS(MAX)} - V_{CS(MIN)}}{V_{CS(MAX)} + V_{CS(MIN)}} = 0.18$$

$$I_{L(RMS)} = \sqrt{I_L^2 + \frac{1}{12} \Delta I_L^2} \approx I_L$$

$$I_{L(PK)} = I_L + \frac{1}{2} \Delta I_L = 1.09 I_L$$

where:

I_L is inductor average current.

Select an inductor with saturation current rating at least 30% higher than the peak current.

Free-Wheeling Diode

The free-wheeling diode should have the reverse voltage rating to accommodate the maximum input voltage. The forward voltage drop should be small to get the lowest conduction dissipation for high efficiency. The forward current rating has to be at least equal to LED current. A Schottky diode is recommended for highest efficiency.

Input Capacitor

The ceramic input capacitor is selected by voltage rating and ripple current rating. To determine the input current ripple rating, the RMS value of the input capacitor can be found by:

$$I_{CIN(RMS)} = I_{LED} \times \sqrt{D \times (1-D)}$$

The power loss in the input capacitor is:

$$P_{LOSS(CIN)} = I_{CIN(RMS)}^2 \times C_{IN(ESR)}$$

The input capacitor current rating can be considered as I_{LED}/2 under the worst condition D = 50%.

LED Ripple Current

The LED current is the same as inductor current. If LED ripple current needs to be reduced then place a 4.7μF/50V ceramic capacitor across LED.

Frequency Dithering

The MIC3202 is designed to reduce EMI by dithering the switching frequency ±12% in order to spread the noise spectrum over a wider range. This lowers the EMI noise peaks generated by the switching regulator.

Switching regulators generate noise by their nature and they are the main EMI source to interference with nearby circuits. If the switching frequency of a regulator is modulated via frequency dithering, the energy of the EMI is spread among many frequencies instead of concentrated at fundamental switching frequency and its harmonics. The MIC3202 modulates the V_{CS(MAX)} with amplitude ±6mV by a pseudo random generator to generate the ±12% of the switching frequency dithering to reduce the EMI noise peaks.

PCB Layout Guidelines

Warning!!! To minimize EMI and output noise, follow these layout recommendations.

PCB Layout is critical to achieve reliable, stable and efficient performance. A ground plane is required to control EMI and minimize the inductance in power, signal and return paths.

The following guidelines should be followed to insure proper operation of the MIC3202 regulator.

IC

Use thick traces to route the input and output power lines.

Signal and power grounds should be kept separate and connected at only one location.

Input Capacitor

Place the input capacitors on the same side of the board and as close to the IC as possible.

Keep both the VIN and PGND traces as short as possible.

Place several vias to the ground plane close to the input capacitor ground terminal, but not between the input capacitors and IC pins.

Use either X7R or X5R dielectric input capacitors. Do not use Y5V or Z5U type capacitors.

Do not replace the ceramic input capacitor with any other type of capacitor. Any type of capacitor can be placed in parallel with the input capacitor.

If a Tantalum input capacitor is placed in parallel with the input capacitor, it must be recommended for switching regulator applications and the operating voltage must be derated by 50%.

In "Hot-Plug" applications, a Tantalum or Electrolytic bypass capacitor must be placed in parallel to ceramic capacitor to limit the over-voltage spike seen on the input supply with power is suddenly applied. In this case an additional Tantalum or Electrolytic bypass input capacitor of 22 μ F or higher is required at the input power connection if necessary.

Inductor

Keep the inductor connection to the switch node (LX Pin) short.

Do not route any digital lines underneath or close to the inductor.

To minimize noise, place a ground plane underneath the inductor.

Output Capacitor

If LED ripple current needs to be reduced then place a 4.7 μ F/50V capacitor across LED. The capacitor must be placed as close to the LED as possible.

Diode

Place the Schottky diode on the same side of the board as the IC and input capacitor.

The connection from the Schottky diode's Anode to the switching node must be as short as possible.

The diode's Cathode connection to the R_{CS} must be kept as short as possible.

RC Snubber

Place the RC snubber on the same side of the board and as close to the Schottky diode as possible. Also the snubber closest to LX pin and PGND pin.

R_{CS} (Current-Sense Resistor)

Make a Kelvin connection to the VIN and CS pins respectively for current sensing.

Trace Routing Recommendation

Keep the power traces as short and wide as possible. One current flowing loop is during the internal MOSFET ON time, the traces connecting the input capacitor C_{IN}, R_{CS}, LEDs, Inductor, the LX pin, PGND and back to C_{IN}. The other current flowing loop is during the internal MOSFET OFF time, the traces connecting R_{CS}, LED, inductor, free wheeling diode and back to R_{CS}. These two loop areas should be kept as small as possible to minimize the noise interference,

Keep all analog signal traces away from the switching node and its connecting traces.

Ripple Measurements

To properly measure ripple on either input or output of a switching regulator, a proper ring in tip measurement is required. Standard oscilloscope probes come with a grounding clip, or a long wire with an alligator clip. Unfortunately, for high-frequency measurements, this ground clip can pick-up high-frequency noise and erroneously inject it into the measured output ripple.

The standard evaluation board accommodates a home made version by providing probe points for both the input and output supplies and their respective grounds. This requires the removing of the oscilloscope probe sheath and ground clip from a standard oscilloscope probe and wrapping a non-shielded bus wire around the oscilloscope probe. If there does not happen to be any non-shielded bus wire immediately available, the leads from axial resistors will work. By maintaining the shortest possible ground lengths on the oscilloscope probe, true ripple measurements can be obtained.



Figure 2. Low-Noise Measurement

Evaluation Board Schematic

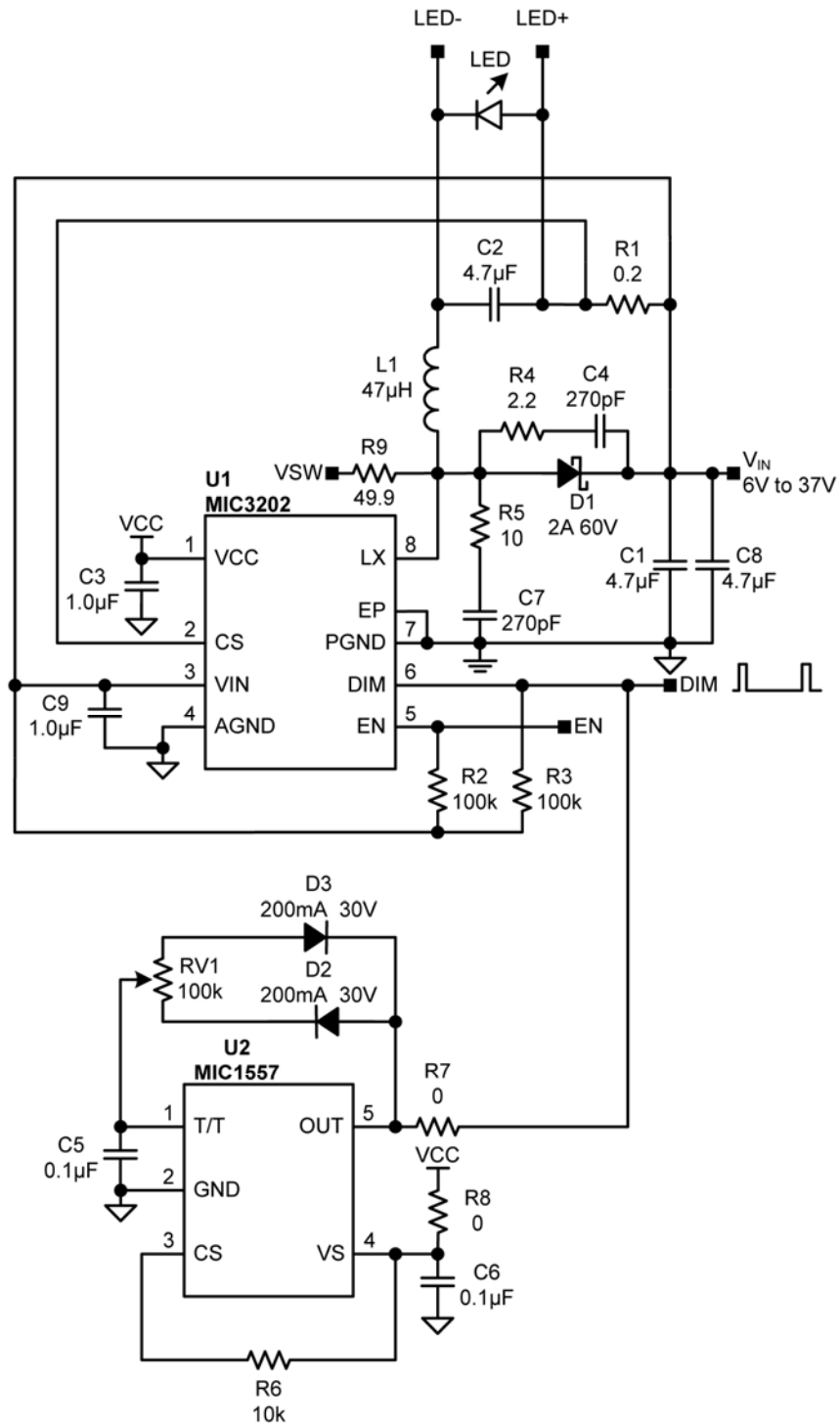

Figure 3. MIC3202 Application Circuit (R9 is for test purposes only)

Bill of Materials

| Item | Part Number | Manufacturer | Description | Qty. |
|------------|--------------------|---|---|------|
| C1, C2, C8 | 12105C475KAZ2A | AVX ⁽¹⁾ | 4.7µF/50V, Ceramic Capacitor, X7R, Size 1210 | 2 |
| | GRM32ER71H475KA88L | Murata ⁽²⁾ | | |
| C3, C9 | 08053D105KAT2A | AVX ⁽¹⁾ | 1µF/25V, Ceramic Capacitor, X5R, Size 0805 | 1 |
| | GRM21BR71E105KA99L | Murata ⁽²⁾ | | |
| | C2012X7R1E105K | TDK ⁽³⁾ | | |
| C4, C7 | 06035C271KAT2A | AVX ⁽¹⁾ | 270pF/50V, Ceramic Capacitor NPO, Size 0603 | 2 |
| | GRM188R71H271KA01D | Murata ⁽²⁾ | | |
| C5, C6 | 06035C104MAT | AVX ⁽¹⁾ | 0.1µF/50V, Ceramic Capacitor, X7R, Size 0603 | 2 |
| | GRM188R71H104KA93D | Murata ⁽²⁾ | | |
| | C1608X7R1H104K | TDK ⁽³⁾ | | |
| D1 | SS24-TP | MCC ⁽⁴⁾ | 60V, 2A, SMA, Schottky Diode | 1 |
| | SS24 | Fairchild ⁽⁵⁾ | | |
| D2, D3 | B0530WS-TP | MCC ⁽⁴⁾ | 30V, 200mA, Schottky diode, SOD-323 | 2 |
| L1 | SLF10145T-470M1R4 | TDK ⁽³⁾ | 47µH, 1.4A, SMT, Power Inductor | 1 |
| R1 | CSR 1/2 0.2 1% I | Stackpole Electronics, Inc ⁽⁷⁾ | 0.2Ω Resistor, 1/2W, 1%, Size 1206 | 1 |
| R2, R3 | CRCW06031003FKEA | Vishay ⁽⁸⁾ | 100kΩ Resistor, 1%, Size 0603 | 2 |
| R4 | CRCW08052R20FKEA | Vishay ⁽⁸⁾ | 2.2Ω Resistor, 1%, Size 0805 | 1 |
| R5 | CRCW080510R0FKEA | Vishay ⁽⁸⁾ | 10Ω Resistor, 1%, Size 0805 | 1 |
| R6 | CRCW060310K0FKEA | Vishay ⁽⁸⁾ | 10kΩ Resistor, 1%, Size 0603 | 1 |
| R7, R8 | CRCW06030000FKEA | Vishay ⁽⁸⁾ | 0Ω Resistor, 1%, Size 0603 | 2 |
| R9 | CRCW060349R9FKEA | Vishay ⁽⁸⁾ | 49.9Ω Resistor, 1%, Size 0603 | 1 |
| RV1 | 3386P-1-104TLF | Bourns ⁽⁹⁾ | POT 100kΩ 3/8" SQ CERM SL ST | 1 |
| U1 | MIC3202YM | Micrel, Inc. ⁽¹⁰⁾ | High Brightness LED Driver with High-Side Current Sense | 1 |
| U2 | MIC1557YM5 | Micrel, Inc. ⁽¹⁰⁾ | RC Time/Oscillator (SOT-23-5) | 1 |

Notes:

1. AVX: www.avx.com.
2. Murata: www.murata.com.
3. TDK: www.tdk.com.
4. MCC: www.mccsemi.com.
5. Fairchild: www.fairchildsemi.com.
6. Diodes Inc. : www.diodes.com.
7. Stackpole Electronics: www.seielect.com.
8. Vishay: www.vishay.com.
9. Bourns Inc : www.bourns.com.
10. Micrel, Inc.: www.micrel.com.

PCB Layout Recommendation

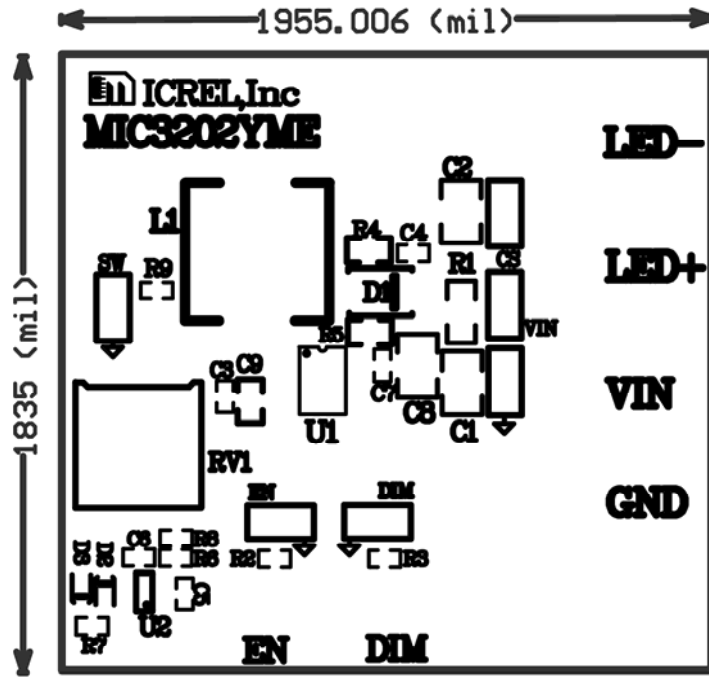

Top Assembly

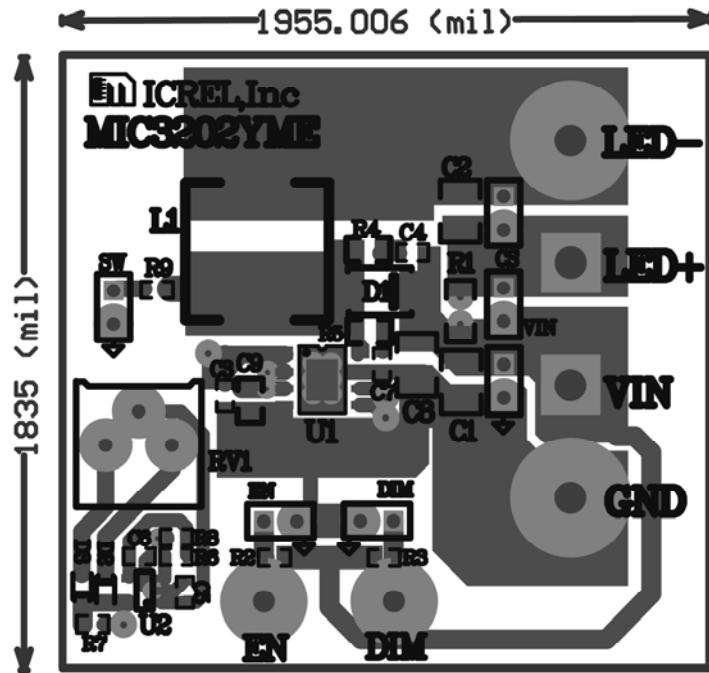

Top Layer

PCB Layout Recommendation (Continued)

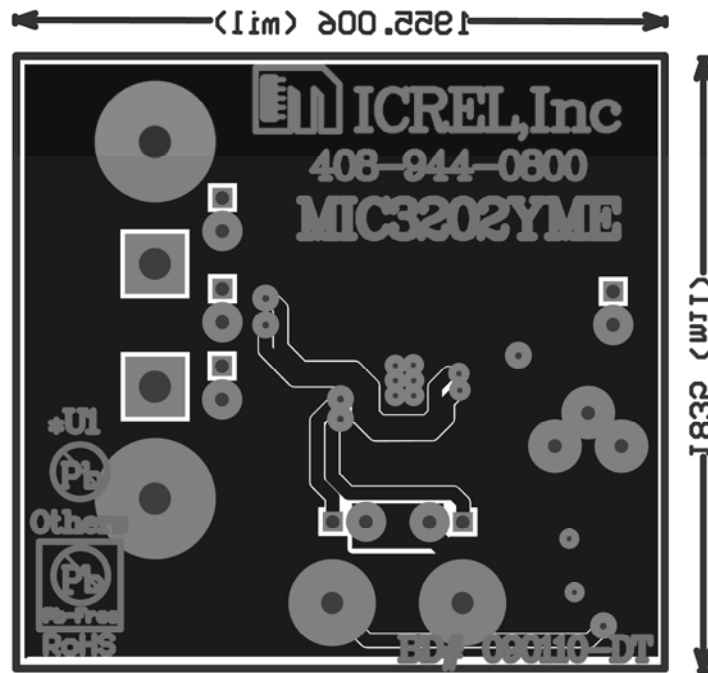

Bottom Layer

Package Information

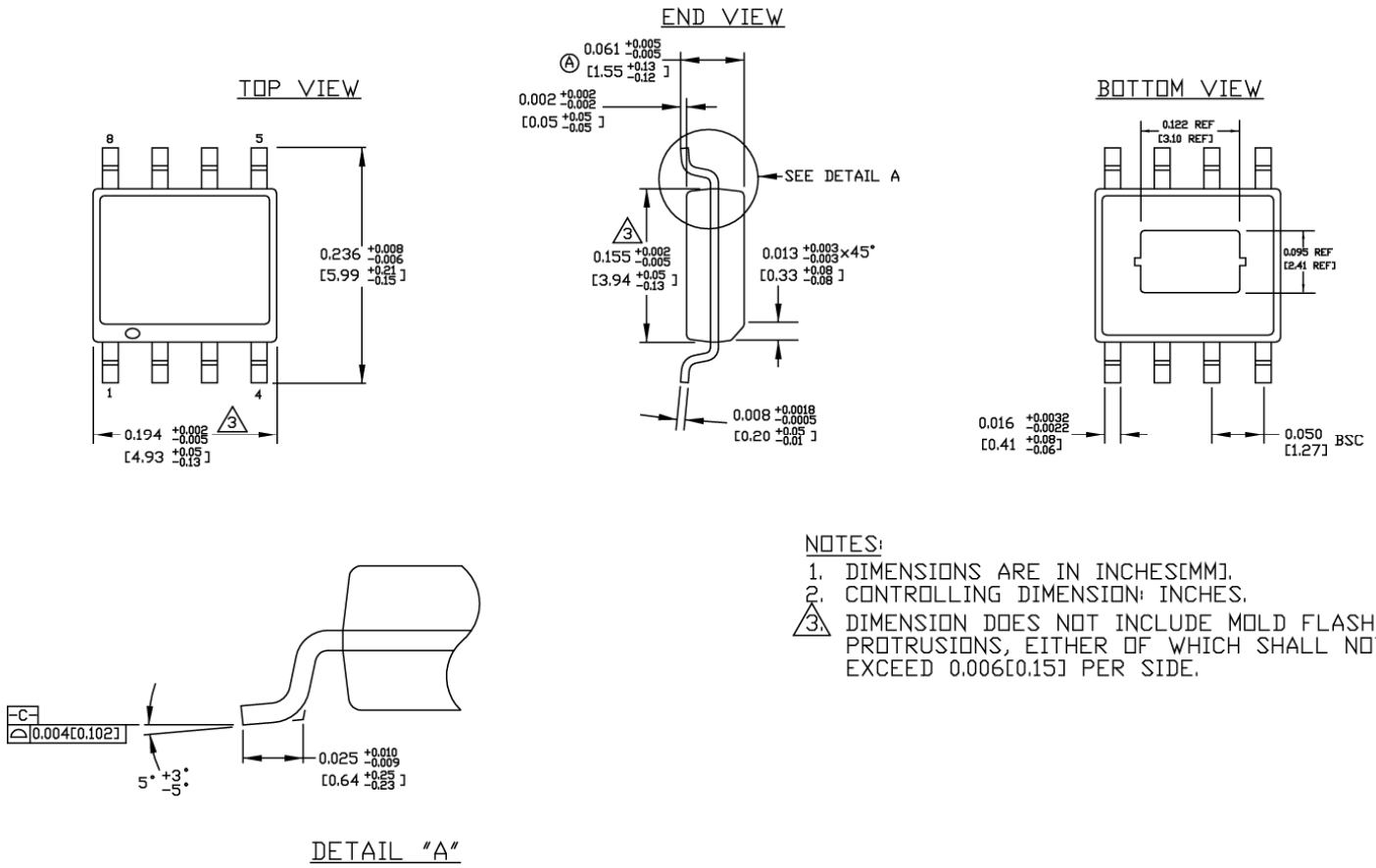

8-Pin ePAD SOIC (ME)

Recommended Landing Pattern

LP # SOICNEP-8LD-LP-1
 All units are in inches
 Tolerance ± 0.05 if not noted

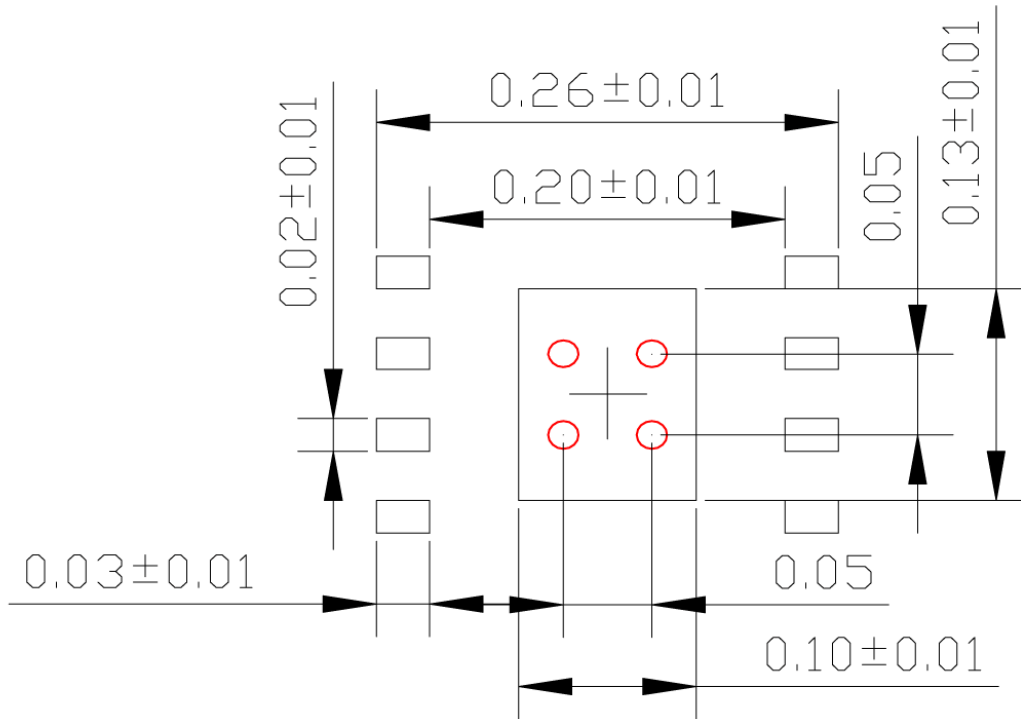

Red circle indicates Thermal Via. Size should be .015-.017 inches in diameter and it should be connected to GND plane for maximum thermal performance.

8-Pin ePAD SOIC (ME)

MICREL, INC. 2180 FORTUNE DRIVE SAN JOSE, CA 95131 USA
 TEL +1 (408) 944-0800 FAX +1 (408) 474-1000 WEB <http://www.micrel.com>

Micrel makes no representations or warranties with respect to the accuracy or completeness of the information furnished in this data sheet. This information is not intended as a warranty and Micrel does not assume responsibility for its use. Micrel reserves the right to change circuitry, specifications and descriptions at any time without notice. No license, whether express, implied, arising by estoppel or otherwise, to any intellectual property rights is granted by this document. Except as provided in Micrel's terms and conditions of sale for such products, Micrel assumes no liability whatsoever, and Micrel disclaims any express or implied warranty relating to the sale and/or use of Micrel products including liability or warranties relating to fitness for a particular purpose, merchantability, or infringement of any patent, copyright or other intellectual property right

Micrel Products are not designed or authorized for use as components in life support appliances, devices or systems where malfunction of a product can reasonably be expected to result in personal injury. Life support devices or systems are devices or systems that (a) are intended for surgical implant into the body or (b) support or sustain life, and whose failure to perform can be reasonably expected to result in a significant injury to the user. A Purchaser's use or sale of Micrel Products for use in life support appliances, devices or systems is a Purchaser's own risk and Purchaser agrees to fully indemnify Micrel for any damages resulting from such use or sale.

© 2010 Micrel, Incorporated.

Данный компонент на территории Российской Федерации

Вы можете приобрести в компании MosChip.

Для оперативного оформления запроса Вам необходимо перейти по данной ссылке:

<http://moschip.ru/get-element>

Вы можете разместить у нас заказ для любого Вашего проекта, будь то серийное производство или разработка единичного прибора.

В нашем ассортименте представлены ведущие мировые производители активных и пассивных электронных компонентов.

Нашей специализацией является поставка электронной компонентной базы двойного назначения, продукции таких производителей как XILINX, Intel (ex.ALTERA), Vicor, Microchip, Texas Instruments, Analog Devices, Mini-Circuits, Amphenol, Glenair.

Сотрудничество с глобальными дистрибьюторами электронных компонентов, предоставляет возможность заказывать и получать с международных складов практически любой перечень компонентов в оптимальные для Вас сроки.

На всех этапах разработки и производства наши партнеры могут получить квалифицированную поддержку опытных инженеров.

Система менеджмента качества компании отвечает требованиям в соответствии с ГОСТ Р ИСО 9001, ГОСТ РВ 0015-002 и ЭС РД 009

Офис по работе с юридическими лицами:

105318, г.Москва, ул.Щербаковская д.3, офис 1107, 1118, ДЦ «Щербаковский»

Телефон: +7 495 668-12-70 (многоканальный)

Факс: +7 495 668-12-70 (доб.304)

E-mail: info@moschip.ru

Skype отдела продаж:

moschip.ru

moschip.ru_4

moschip.ru_6

moschip.ru_9