

3 Series Thumbwheel Switches



Features/Benefits

- Most complete product offering in the industry
- Spacers available to fit most panel cutouts
- Front or rear mounting options

Typical Applications

- Test & measurement equipment
- Industrial equipment
- Computer devices

Specifications

CONTACT RATING:

CARRY: 1 AMP continuous.
SWITCH: 100 mA max.

OPERATING VOLTAGE: 50 mV to 28 V DC or 120 V AC.

ELECTRICAL LIFE: 100,000 actuations.

CONTACT RESISTANCE: Below 100 m Ω typ. initial @
2-4 V DC, 100 mA.

INSULATION RESISTANCE: 10⁹ Ω min.

DIELECTRIC STRENGTH: 500 Vrms min. @ sea level
between common terminal and any output.

OPERATING TEMPERATURE: -40°C to 65°C.

Materials

HOUSING: ABS plastic.

THUMBWHEEL: ABS plastic.

ROTOR CONTACTS: Precious metal on copper alloy.

STATOR CONTACTS: Hard gold over nickel over copper
on epoxy fiberglass.

NOTE: Specifications and materials listed above are for switches with standard options
For information on specific and custom switches, consult Customer Service Center.

* Note: All models listed are RoHS compliant. See Technical Data section of this catalog for
RoHS compliant and compatible definitions and specifications.

Build-A-Switch

To order, simply select desired option from each category and place in the appropriate box. Available options are shown and described on pages M-4 thru M-10. For additional options not shown in catalog, consult Customer Service Center.

Consult factory for illumination availability.

<p>Series</p> <p>3 Thumbwheel switch</p>	<p>Number of Sections</p> <p>0 Switch section 1 1 Switch section 2 2 Switch sections 3 3 Switch sections 4 4 Switch sections 5 5 Switch sections 6 6 Switch sections 7 7 Switch sections 8 8 Switch sections 9 More than 8 switch sections</p>	<p>Function Code</p> <p>11 Decimal, SP, 10 position 14 Resistor decade 21 BCD, 10 position 23 Complement of BCD, 10 position 27 BCD, 10 position 31 BCD, 10 position 71 BCH, 16 position</p>	<p>Mounting Style</p> <p>00 Snap-in, front mount 09 Snap-in, front mount* 10 Rear mount 19 Rear mount* 20 Rear mount 29 Rear mount*</p>	<p>Terminations</p> <p>0 Type 0 1 Type 1, extended type 0 N Solder pins with .100" spacing** P Solder pins with .156" spacing** 9 Any combination</p>	<p>Color/Marking/Stops</p> <p>0 Matte black body, gloss black wheel, white marking</p>	<p>Seal</p> <p>0 No seal 1 Sealed contacts 2 Dust lens 3 Sealed contacts & dust lens</p>
--	---	--	--	---	--	---

*X9 mounting styles must be ordered with '0' number of sections.

** Note: Termination option N (RoHS compliant) replaced termination option 3 (Non-RoHS compliant).
Termination option P (RoHS compliant) replaced termination option B (Non-RoHS compliant).

Thumbwheel & Pushwheel



3 Series Thumbwheel Switches

SERIES

3 THUMBWHEEL SWITCHES

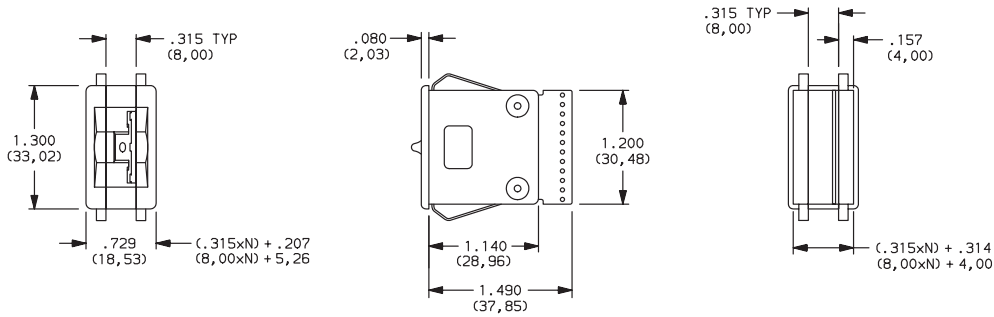

NUMBER OF SECTIONS

- 0 Switch section only, no assembly. Blank bodies are considered sections; endplates are not sections. Must be ordered with 09 or 19 mounting style options, see pages M-5 and M-6.
- 1-8 Number of switch sections in assembly, includes endplates.
- 9 More than 8 switch sections, specify on CONFIGURATION FORM, page M-10 and consult Customer Service Center.

NOTE: Endplates and blank sections available separately, see pages M-13 and M-14.

FUNCTION CODE

- 11 DECIMAL-1 POLE; 10 POSITION
- 14 RESISTOR DECADE; 1-2-2-2-2 CODE (RESISTORS NOT SUPPLIED)
- 21 BCD 1-2-4-8; 10 POSITION

W H E E L	SIGNALS CONNECTED TO COMMON SIGNAL C										C
	0	1	2	3	4	5	6	7	8	9	
0	●										●
1		●									●
2			●								●
3				●							●
4					●						●
5						●					●
6							●				●
7								●			●
8									●		●
9										●	●
	2	3	4	5	6	7	8	9	10	11	12
	TERM. LOCATION										

Available Terminations: 0, 1, N
See fig. 1, page M-7.

W H E E L	SWITCH CIRCUIT										
	0	1	2	3	4	5	6	7	8	9	
0	●									●	
1	●	●								●	
2	●	●	●							●	
3	●	●	●	●						●	
4	●	●	●	●	●					●	
5	●	●	●	●	●	●				●	
6	●	●	●	●	●	●	●			●	
7	●	●	●	●	●	●	●	●		●	
8	●	●	●	●	●	●	●	●	●	●	
9	●	●	●	●	●	●	●	●	●	●	
	11	9	7	5	3	1,2	12				
	TERM. LOCATION										

Available Terminations: 1
See fig. 1, page M-7.

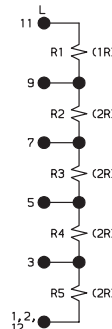

W H E E L	SIGNALS CONN. TO COMM. SIG. C										C
	1	2	4	8							
0											●
1	●										●
2		●									●
3	●	●									●
4			●								●
5	●			●							●
6		●			●						●
7	●	●				●					●
8							●				●
9	●							●			●
	3	5	7	11	9						
	TERM. LOCATION										

Available Terminations: 0, 1, N
See fig. 1, page M-7.

NOTE: For terminal location diagram, see page M-7.



Dimensions are shown: Inches (mm)
Specifications and dimensions subject to change



3 Series Thumbwheel Switches

FUNCTION CODE

23 COMPLEMENT OF BCD 1-2-4-8;
10 POSITION

W H E E L	SIGNALS CONN. TO			
	1	2	4	8
0	●	●	●	●
1	●	●	●	●
2	●	●	●	●
3	●	●	●	●
4	●	●	●	●
5	●	●	●	●
6	●	●	●	●
7	●	●	●	●
8	●	●	●	●
9	●	●	●	●
	3	9	11	5
	TERM. LOCATION			

Available Terminations: 0, 1, N
See fig. 1, page M-7.

27 BCD 1-2-4-8; 10 POSITION

W H E E L	SIGNALS CONN. TO			
	1	2	4	8
0				
1	●			●
2		●		●
3	●			●
4		●		●
5	●			●
6		●		●
7	●			●
8		●		●
9	●			●
	4	5	1	2
	TERM. LOCATION			

Available Terminations: P
See fig. 2, page M-7.

31 BCD 1-2-4-8; 10 POSITION

W H E E L	SIGNALS CONN. TO			
	1	2	4	8
0				
1	●			●
2		●		●
3	●			●
4		●		●
5	●			●
6		●		●
7	●			●
8		●		●
9	●			●
	2	3	11	9
	TERM. LOCATION			

Available Terminations: 0, 1, N
See fig. 1, page M-7.

71 BINARY CODED HEXADECIMAL,
16 POSITION

W H E E L	SIGNALS CONN. TO			
	1	2	4	8
0				
1	●			●
2		●		●
3	●			●
4		●		●
5	●			●
6		●		●
7	●			●
8		●		●
9	●			●
A	●	●	●	●
B	●	●	●	●
C	●	●	●	●
D	●	●	●	●
E	●	●	●	●
F	●	●	●	●
	3	5	7	11
	TERM. LOCATION			

Available Terminations: 0, 1, N
See fig. 1, page M-7.

NOTE: For terminal location diagram, see page M-7.

MOUNTING STYLE

Type 0 Snap-In Front Mount

MOUNTING STYLE	DIM. 'A'
00	(.315 x N) + .326 (8,00 x N) + (8,28)

N = Number of sections.

Recommended panel thickness:
0.46-.125
(1,16-3,18)

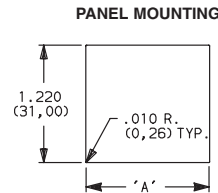

00 SWITCH ASSEMBLY W/ ENDPLATES--.315 (8,00) SECTION PITCH

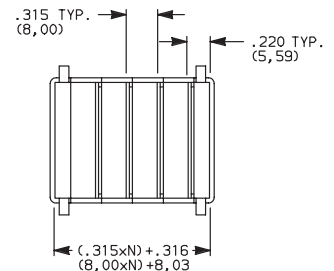
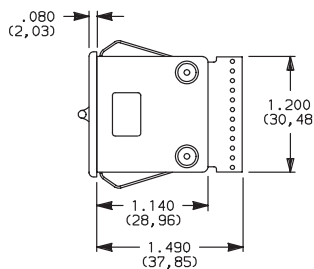
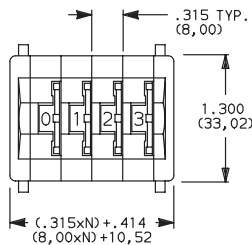

N = Number of sections.

09 SWITCH SECTION ONLY--UNASSEMBLED WITHOUT ENDPLATES OR SPACERS
(Must be ordered with number of sections option "0", see Page M-4.)

NOTE: Endplates, blank sections, spacers
and assembly hardware available separately, see pages M-8 and M-9.



Dimensions are shown: Inches (mm)
Specifications and dimensions subject to change



3 Series Thumbwheel Switches

MOUNTING STYLE

Type 1 Rear Mount

MOUNTING STYLE	DIM. 'A'	DIM. 'B'
10	(.350 x N) + .340 (8,89 x N) + (8,64)	(.350 x N) + .560 (8,89 x N) + (14,22)

N = Number of sections.

Recommended panel thickness:
0.46-.125
(1,16-3,18)

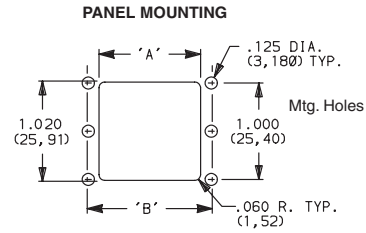

10 SWITCH ASSEMBLY W/ ENDPLATES-.350 (8,89) SECTION PITCH

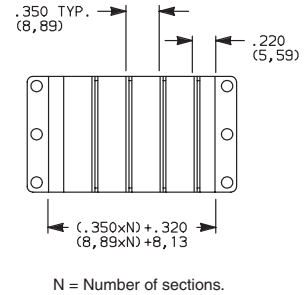
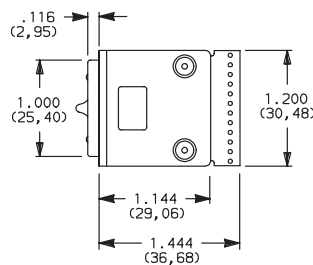
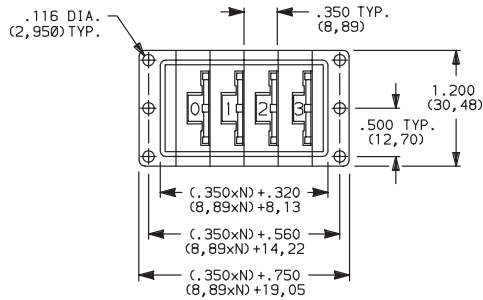

19 SWITCH SECTION ONLY-UNASSEMBLED WITHOUT ENDPLATES OR SPACERS (Must be ordered with number of sections option "0", see Page M-4.)

Thumbwheel & Pushwheel

Type 2 Rear Mount

20 SWITCH ASSEMBLY W/ ENDPLATES-.350 (8,89) SECTION PITCH

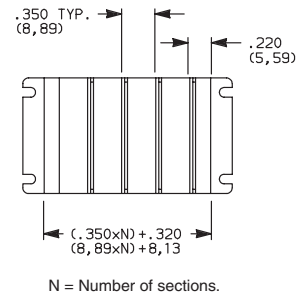
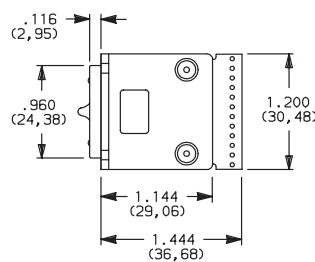
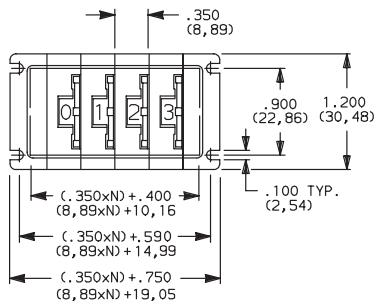

29 SWITCH SECTION ONLY-UNASSEMBLED WITHOUT ENDPLATES OR SPACERS (Must be ordered with number of sections option "0", see Page M-4.)



M

NOTE: Endplates, blank sections, spacers and assembly hardware available separately, see pages M-8 and M-9.



Dimensions are shown: Inches (mm)
Specifications and dimensions subject to change

C&K

3 Series Thumbwheel Switches

TERMINATIONS

0 TYPE 0

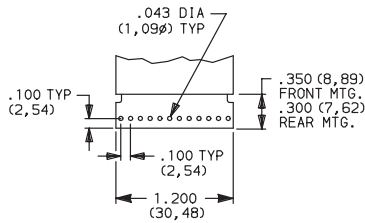

1 TYPE 1, EXTENDED TYPE 0

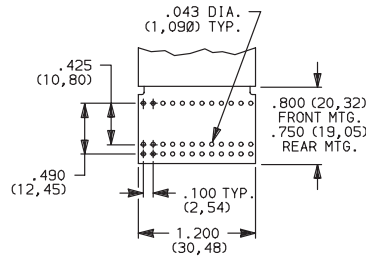

Signal traces cut except for common(s).

N SOLDER PINS WITH .100" SPACING

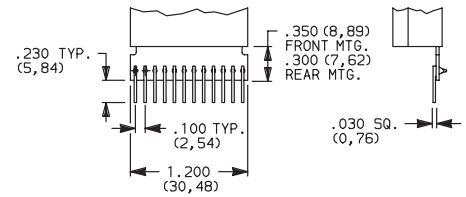

9 ANY COMBINATION OF TERMINATION CONFIGURATIONS OR SPECIAL TERMINATIONS.

Specify on configuration form, page M-10 and consult Customer Service Center.

P SOLDER PINS WITH .156" SPACING

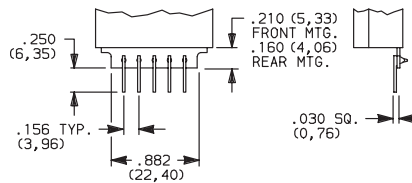

PC Board 1/32" (0,79) thick.

NOTE: All terminal holes shown may not be present for all function codes, consult Customer Service Center. Terminal connector available for termination options 0 & 1, see page M-9.

NOTE: Termination option N (RoHS compliant) replaced termination option 3 (Non-RoHS compliant). Termination option P (RoHS compliant) replaced termination option B (Non-RoHS compliant).

Terminal Location Numbers

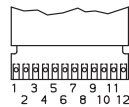

FIG. 1

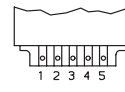

FIG. 2

NOTE: See function codes, pages M-4 and M-5, for signal locations.

COLOR/MARKING/STOPS

0 MATTE BLACK HOUSING (Gloss black wheel with white characters; no stops.)

NOTE: Stop pins are available separately, see page M-8.

SEAL

0 UNSEALED SWITCHING CONTACTS.

1 SEALED SWITCHING CONTACTS. (Sealing is by means of an o-ring rotary seal and a cured-in-place elastomer gasket. Switching contact area is protected from moisture, oil, and airborne contaminants.)

2 DUST LENS. (Protects the character face of the wheel from abrasion and dirt).

3 SEALED SWITCHING CONTACTS AND DUST LENS

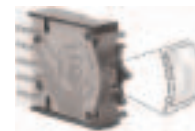

Dust Lens



Third Angle Projection
Dimensions are shown: Inches (mm)
Specifications and dimensions subject to change



3 Series Thumbwheel Switches

AVAILABLE HARDWARE

Blank sections, Type 0,
.315 THK.



PART NO.
413602000 W/RIB-BLACK
400502000 W/RIB & W/OUT SPRINGS-BLACK

Blank sections, Front mount, Type 0,
.315 THK.



PART NO.
413502000 PLAIN-BLACK
400702000 PLAIN & W/OUT SPRINGS-BLACK

Blank sections, Rear mount, Type 1,
.350 THK.



4006 4008

PART NO.
400602000 W/RIB-BLACK
400802000 PLAIN-BLACK

Blank sections, Rear mount, Type 2,
.350 THK.



4734 4733

PART NO.
473402000 W/RIB-BLACK
473302000 PLAIN-BLACK

End plates, Front mount, Type 0



PART NO.
413402000 BLACK
 Two required for complete assembly.

End plates, Rear mount, Type 1



PART NO.
400402003 BLACK
 Two required for complete assembly.

End plates, Rear mount, Type 2



PART NO.
473202003 BLACK
 Two required for complete assembly.

Spacers, Front mount, Type 0 & 3, .078 THK.
(Makes section pitch 10mm)



PART NO.
410802000 BLACK

Stop pins



PART NO.
402900000

Thumbwheel & Pushwheel



M



Dimensions are shown: Inches (mm)
 Specifications and dimensions subject to change

3 Series Thumbwheel Switches

AVAILABLE HARDWARE

Terminal connector



605A00000



605A02000

PART NO.

605A00000 PC

605A02000 SOLDER LUG

Fits 0 & 1 terminations only.

Screws for field assembly of thumbwheel switches
(2 screws needed per assembly + 403500000 nuts)

SCREW PART NUMBER (0-80 UNF THD. SIZE)	NUMBER OF SECTIONS IN ASSEMBLY	
	FRONT MOUNTING	REAR MOUNTING
	MTG. STYLE - 00	MTG. STYLE - 10
412700000	1-2	1-2
412701000	3-4	3
412702000	5-7	4-6

Nut



Two nuts required per assembly and screws.

PART NO.

403500000

Nut driver (For 403500000 nut)



PART NO.

406100652

Thumbwheel & Pushwheel



M

3 Series Thumbwheel Switches

Configuration Form

GRAY SHADED AREAS TO BE FILLED IN BY CUSTOMER SERVICE.

CATALOG PART NO.

3

C&K PART NUMBER

C&K PART NUMBER

COMPANY NAME _____











CUSTOMER PRINT REVISION:

ADDRESS _____ TEL.# _____

CUSTOMER CONTACT _____ DATE _____

DETAILS:

ORIGINATED BY _____ SALES REP. _____

THUMBWHEEL SECTIONS	NO. OF SEC.	FUNCTION CODE – TERMINATIONS – COLOR/MARKING/STOPS/SEAL – ILLUMINATION <small>ENTER OPTION CODES IN APPROPRIATE BOXES. FUNCTION CODES INCLUDE BLANK SECTIONS (SEE PAGES M-9 & M-10).</small>	DESCRIBE IN APPROPRIATE ROW
	1	3 - <input type="text"/> <input type="text"/> - - <input type="text"/> <input type="text"/> <input type="text"/> <input type="text"/>	
	2	3 - <input type="text"/> <input type="text"/> - - <input type="text"/> <input type="text"/> <input type="text"/> <input type="text"/>	
	3	3 - <input type="text"/> <input type="text"/> - - <input type="text"/> <input type="text"/> <input type="text"/> <input type="text"/>	
	4	3 - <input type="text"/> <input type="text"/> - - <input type="text"/> <input type="text"/> <input type="text"/> <input type="text"/>	
	5	3 - <input type="text"/> <input type="text"/> - - <input type="text"/> <input type="text"/> <input type="text"/> <input type="text"/>	
	6	3 - <input type="text"/> <input type="text"/> - - <input type="text"/> <input type="text"/> <input type="text"/> <input type="text"/>	
	7	3 - <input type="text"/> <input type="text"/> - - <input type="text"/> <input type="text"/> <input type="text"/> <input type="text"/>	
	8	3 - <input type="text"/> <input type="text"/> - - <input type="text"/> <input type="text"/> <input type="text"/> <input type="text"/>	
	9	3 - <input type="text"/> <input type="text"/> - - <input type="text"/> <input type="text"/> <input type="text"/> <input type="text"/>	
	10	3 - <input type="text"/> <input type="text"/> - - <input type="text"/> <input type="text"/> <input type="text"/> <input type="text"/>	
	11	3 - <input type="text"/> <input type="text"/> - - <input type="text"/> <input type="text"/> <input type="text"/> <input type="text"/>	

Thumbwheel & Pushwheel



QUALITY CONTROL INSTRUCTIONS

PRODUCTION APPROVAL DATE

Q.C. APPROVAL DATE

REV. INITIALS DATE

FOR SWITCHES WITH MORE THAN 11 SECTIONS, CONTINUE ON ADDITIONAL SHEETS.

SPECIAL INSTRUCTIONS OR SPECIFICATIONS:

SHEET ____ OF ____



Dimensions are shown: Inches (mm)
Specifications and dimensions subject to change

Данный компонент на территории Российской Федерации

Вы можете приобрести в компании MosChip.

Для оперативного оформления запроса Вам необходимо перейти по данной ссылке:

<http://moschip.ru/get-element>

Вы можете разместить у нас заказ для любого Вашего проекта, будь то серийное производство или разработка единичного прибора.

В нашем ассортименте представлены ведущие мировые производители активных и пассивных электронных компонентов.

Нашей специализацией является поставка электронной компонентной базы двойного назначения, продукции таких производителей как XILINX, Intel (ex.ALTERA), Vicor, Microchip, Texas Instruments, Analog Devices, Mini-Circuits, Amphenol, Glenair.

Сотрудничество с глобальными дистрибьюторами электронных компонентов, предоставляет возможность заказывать и получать с международных складов практически любой перечень компонентов в оптимальные для Вас сроки.

На всех этапах разработки и производства наши партнеры могут получить квалифицированную поддержку опытных инженеров.

Система менеджмента качества компании отвечает требованиям в соответствии с ГОСТ Р ИСО 9001, ГОСТ РВ 0015-002 и ЭС РД 009

Офис по работе с юридическими лицами:

105318, г.Москва, ул.Щербаковская д.3, офис 1107, 1118, ДЦ «Щербаковский»

Телефон: +7 495 668-12-70 (многоканальный)

Факс: +7 495 668-12-70 (доб.304)

E-mail: info@moschip.ru

Skype отдела продаж:

moschip.ru

moschip.ru_4

moschip.ru_6

moschip.ru_9