

## Data Sheet



### Description

This 1 W Mini Power LED Light Source is a high performance energy-efficient device that can handle high thermal and high driving current. An option with an electrically isolated metal slug is also available.

The White Mini Power LED is available in the range of color temperature from 2700 K to 10000 K.

The low profile package design and ultra small footprint is suitable for a wide variety of applications especially where space and height is a constraint.

The package is compatible with reflow soldering process. To facilitate easy pick and place assembly, the LEDs are packed in EIA-compliant tape and reel.

### Features

- Available in red, amber, blue, royal blue, cyan, green, cool white, neutral white, and warm white colors
- Small footprint
- Energy efficient
- Direct heat transfer from metal slug to motherboard
- Compatible with reflow soldering process
- High current operation
- Long operation life
- Wide viewing angle
- Silicone encapsulation
- Non-ESD sensitive (threshold > 16 kV)
- MSL 1 products

### Applications

- Architectural lighting
- Garden lighting
- Decorative lighting
- Sign backlight
- Safety, exit and emergency sign lightings
- Specialty lighting such as task lighting and reading lights
- Retail display
- Commercial lighting
- Accent or marker lightings, strip, or step lightings
- Portable lightings, bicycle head lamp, torch lights
- Pathway lighting
- Street lighting
- Tunnel lighting

**CAUTION:** The customer is advised to keep the LEDs in the MBB when not in use as prolonged exposure to environment might cause the silver plated leads to tarnish, which might cause difficulties in soldering.

Figure 1 ASMT-Jx1x Package Outline Drawing

**NOTE**

1. All dimensions in millimeters.
2. Metal slug is connected to anode for electrically non-isolated option.
3. Tolerance is  $\pm 0.1$  mm unless otherwise specified.
4. Terminal finish: Ag plating.
5. Corresponding NC (No Connection) leads adjacent to anode and cathode leads can be electrically short.

## Device Selection Guide ( $T_J = 25^\circ\text{C}$ )

| Part Number     | Color         | Luminous Flux (lm) / Radiometric Power (mW), $\Phi_V$ <sup>a, b</sup> |        |        | Test Current (mA) | Dice Technology | Electrically Isolated Metal Slug |
|-----------------|---------------|---|--------|--------|-------------------|-----------------|----------------------------------|
|                 |               | Min.  | Typ.   | Max.   |                   |                 |                                  |
| ASMT-JR10-AST01 | Red           | 51.7  | 62.0   | 87.4   | 350               | AllnGaP         | No                               |
| ASMT-JA10-ARS01 | Amber         | 39.8  | 48.0   | 67.2   | 350               | AllnGaP         | No                               |
| ASMT-JB11-NNQ01 | Blue          | 18.1  | 24.0   | 39.8   | 350               | InGaN           | Yes                              |
| ASMT-JL11-NQS01 | Royal Blue    | 435 mW  | 550 mW | 685 mW | 350               | InGaN           | Yes                              |
| ASMT-JC11-NTU01 | Cyan          | 67.2  | 75.0   | 99.6   | 350               | InGaN           | Yes                              |
| ASMT-JG11-NUW01 | Green         | 87.4  | 110.0  | 129.5  | 350               | InGaN           | Yes                              |
| ASMT-JW11-NWX01 | Cool White    | 113.6   | 120.0  | 147.7  | 350               | InGaN           | Yes                              |
| ASMT-JN11-NWX01 | Neutral White | 113.6   | 120.0  | 147.7  | 350               | InGaN           | Yes                              |
| ASMT-JY11-NVW01 | Warm White    | 99.6  | 105.0  | 129.5  | 350               | InGaN           | Yes                              |

- a.  $\Phi_V$  is the total luminous flux/radiometric power output as measured with an integrating sphere at 25-ms mono pulse condition.  
b. Flux tolerance is  $\pm 10\%$ .

## Absolute Maximum Ratings

| Parameter  | AllnGaP                       | InGaN       | InGaN Cyan  | Units            |
|--|-------------------------------|-------------|-------------|------------------|
| DC Forward Current <sup>a</sup>                  | 500                           | 500         | 500         | mA               |
| Peak Pulsing Current <sup>b</sup>                | 1000                          | 1000        | 1000        | mA               |
| Power Dissipation                                | 1230                          | 1830        | 1980        | mW               |
| LED Junction Temperature                         | 125                           | 150         | 150         | $^\circ\text{C}$ |
| Operating Metal Slug Temperature Range at 350 mA | -40 to +115                   | -40 to +135 | -40 to +135 | $^\circ\text{C}$ |
| Storage Temperature Range                        | -40 to +120                   | -40 to +120 | -40 to +120 | $^\circ\text{C}$ |
| Soldering Temperature                            | See <a href="#">Figure 29</a> |             |             |                  |
| Reverse Voltage <sup>c</sup>                     | Not recommended               |             |             |                  |

- a. Derate linearly based on [Figure 13](#) and [Figure 14](#) for AllnGaP and [Figure 25](#) and [Figure 26](#) for InGaN.  
b. Pulse condition duty factor = 10%, Frequency = 1 kHz.  
c. Not recommended for reverse bias operation.

## Optical Characteristics at 350 mA ( $T_J = 25^\circ\text{C}$ )

| Part Number     | Color      | Peak Wavelength, $\lambda_{\text{PEAK}}$ (nm) | Dominant Wavelength, $\lambda_D^a$ (nm) | Viewing Angle, $2\theta_{1/2}^b$ (°) | Luminous Efficiency (lm/W) |
|-----------------|------------|---|---|--------------------------------------|----------------------------|
|                 |            | Typ.  | Typ.                                    | Typ.                                 | Typ.                       |
| ASMT-JR10-AST01 | Red        | 635   | 625                                     | 165                                  | 84                         |
| ASMT-JA10-ARS01 | Amber      | 598   | 590                                     | 165                                  | 65                         |
| ASMT-JG11-NUW01 | Green      | 519   | 525                                     | 165                                  | 98                         |
| ASMT-JC11-NTU01 | Cyan       | 497   | 500                                     | 165                                  | 63                         |
| ASMT-JB11-NNQ01 | Blue       | 454   | 460                                     | 165                                  | 21                         |
| ASMT-JL11-NQS01 | Royal Blue | 450   | 455                                     | 165                                  | Not applicable             |

- a. The dominant wavelength,  $\lambda_D$ , is derived from the CIE Chromaticity Diagram and represents the color of the device.  
 b.  $\theta_{1/2}$  is the off-axis angle where the luminous intensity is half of the peak intensity.

| Part Number     | Color         | Correlated Color Temperature, CCT (Kelvin) |       | Viewing Angle, $2\theta_{1/2}^a$ (°) | Luminous Efficiency (lm/W) |
|-----------------|---------------|--|-------|--------------------------------------|----------------------------|
|                 |               | Min.                                       | Max.  | Typ.                                 | Typ.                       |
| ASMT-JW11-NWX01 | Cool White    | 4500                                       | 10000 | 140                                  | 107                        |
| ASMT-JN11-NWX01 | Neutral White | 3500                                       | 4500  | 140                                  | 107                        |
| ASMT-JY11-NVW01 | Warm White    | 2700                                       | 3500  | 140                                  | 95                         |

- a.  $\theta_{1/2}$  is the off-axis angle where the luminous intensity is half of the peak intensity.

## Electrical Characteristic at 350 mA ( $T_J = 25^\circ\text{C}$ )

| Dice Type               | Forward Voltage, $V_F$ (Volts) |      |      | Thermal Resistance, $R_{\theta j-ms}$ ( $^\circ\text{C}/\text{W}$ ) <sup>a</sup> |
|-------------------------|--------------------------------|------|------|--|
|                         | Min.                           | Typ. | Max. | Typ.   |
| AllInGaP                | 1.7                            | 2.1  | 2.3  | 9  |
| InGaN (non-Cyan Colors) | 2.8                            | 3.2  | 3.5  | 9  |
| InGaN Cyan              | 2.6                            | 3.0  | 3.8  | 9  |

- a.  $R_{\theta j-ms}$  is thermal resistance from LED junction to metal slug.

## Part Numbering System

A S M T - J x<sub>1</sub> 1 x<sub>2</sub> - x<sub>3</sub> x<sub>4</sub> x<sub>5</sub> x<sub>6</sub> x<sub>7</sub>

| Code           | Description         | Option                          |                           |
|----------------|---------------------|---------------------------------|---------------------------|
| x <sub>1</sub> | Color               | R                               | Red                       |
|                |                     | A                               | Amber                     |
|                |                     | G                               | Green                     |
|                |                     | B                               | Blue                      |
|                |                     | L                               | Royal Blue                |
|                |                     | W                               | Cool White                |
|                |                     | N                               | Neutral White             |
|                |                     | Y                               | Warm White                |
| x <sub>2</sub> | Heat sink           | 0                               | Electrically Non Isolated |
|                |                     | 1                               | Electrically Isolated     |
| x <sub>3</sub> | Dice Type           | N                               | InGaN                     |
|                |                     | A                               | AllnGaP                   |
| x <sub>4</sub> | Minimum Flux Bin    | See Flux/Power Bin Limits Table |                           |
| x <sub>5</sub> | Maximum Flux Bin    |                                 |                           |
| x <sub>6</sub> | Color Bin Selection | See Color Bin Selection Table   |                           |
| x <sub>7</sub> | Packaging Option    | 0                               | Tube                      |
|                |                     | 1                               | Tape and Reel             |

## Bin Information

### Flux/Power Bin Limit ( $x_4$ , $x_5$ )

| Color        | Bin ID | Luminous Flux (lm)/Radiometric Power (mW) at 350 mA |       |
|--------------|--------|---|-------|
|              |        | Min.  | Max.  |
| Blue         | M      | 13.9  | 18.1  |
|              | N      | 18.1  | 23.5  |
|              | P      | 23.5  | 30.6  |
|              | Q      | 30.6  | 39.8  |
| Other Colors | R      | 39.8  | 51.7  |
|              | S      | 51.7  | 67.2  |
|              | T      | 67.2  | 87.4  |
|              | U      | 87.4  | 99.6  |
|              | V      | 99.6  | 113.6 |
|              | W      | 113.6   | 129.5 |
|              | X      | 129.5   | 147.7 |
| Royal Blue   | M      | 225.0   | 275.0 |
|              | N      | 275.0   | 355.0 |
|              | P      | 355.0   | 435.0 |
|              | Q      | 435.0   | 515.0 |
|              | R      | 515.0   | 595.0 |
|              | S      | 595.0   | 685.0 |

Tolerance for each bin limit is  $\pm 10\%$ .

## Color Bin Selection (x<sub>6</sub>)

Individual reel will contain parts from one color bin selection only.

### Cool White

| Selection | Bin ID                 |
|-----------|------------------------|
| 0         | Full Distribution      |
| E         | VM, UM, VN, and UN     |
| F         | WM, VM, WN, and VN     |
| G         | XM, WM, XN, and WN     |
| H         | UN, VN, U0, and V0     |
| J         | WN, VN, W0, and V0     |
| K         | XN, WN, X0, and W0     |
| L         | V0, U0, VP, and UP     |
| M         | W0, V0, WP, VP, and WQ |
| N         | X0, W0, XP, WP, and WQ |
| P         | Y0                     |
| Q         | YA                     |

### Warm White

| Selection | Bin ID             |
|-----------|--------------------|
| 0         | Full Distribution  |
| E         | NM, MM, N1, and M1 |
| F         | PM, NM, P1, and N1 |
| G         | QM, PM, Q1, and P1 |
| H         | M1, N1, M0, and N0 |
| J         | P1, N1, P0, and N0 |
| K         | Q1, P1, Q0, and P0 |
| L         | N0, M0, NA, and MA |
| M         | P0, N0, PA, and NA |
| N         | Q0, P0, QA, and PA |

### Neutral White

| Selection | Bin ID             |
|-----------|--------------------|
| 0         | Full Distribution  |
| E         | SM, RM, S1, and R1 |
| F         | TM, SM, TN, and S1 |
| G         | S1, R1, S0, and R0 |
| H         | TN, S1, T0, and S0 |
| J         | S0, R0, SA, and RA |
| K         | T0, S0, TP, and SA |

### Other Colors

| Selection | Bin ID            |
|-----------|-------------------|
| 0         | Full Distribution |
| Z         | A and B           |
| Y         | B and C           |
| W         | C and D           |
| V         | D and E           |
| Q         | A, B, and C       |
| P         | B, C, and D       |
| N         | C, D, and E       |
| M         | D, E, and F       |

Figure 2 Color Bin Structure for Cool White

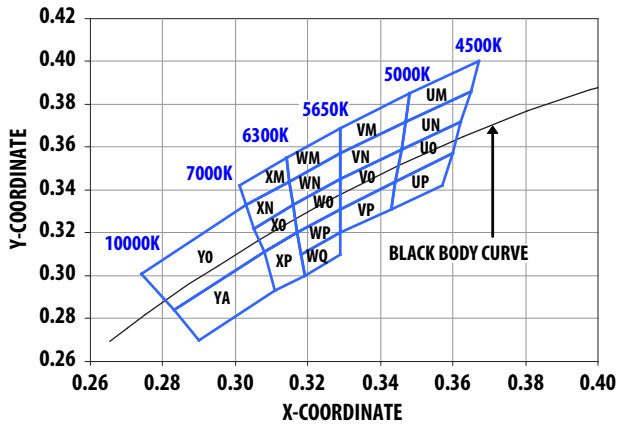
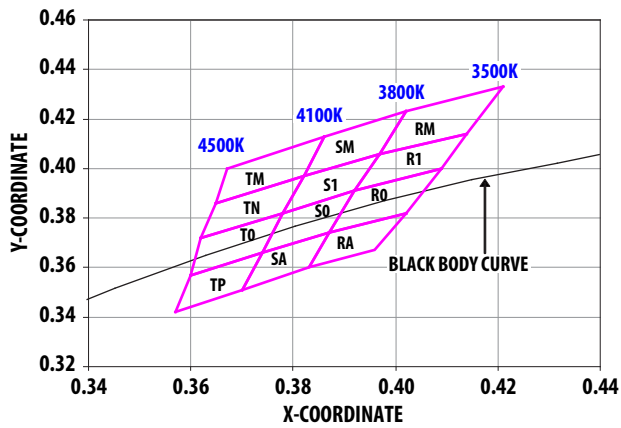


Figure 3 Color Bin Structure for Warm White



Figure 4 Color Bin Structure for Neutral White





## Color Bin Limits

| Cool White | Color Limits (Chromaticity Coordinates) |       |       |       |       |
|------------|---|-------|-------|-------|-------|
| Bin UM     | x                                       | 0.365 | 0.348 | 0.347 | 0.367 |
|            | y                                       | 0.386 | 0.385 | 0.372 | 0.400 |
| Bin UN     | x                                       | 0.365 | 0.362 | 0.346 | 0.347 |
|            | y                                       | 0.386 | 0.372 | 0.359 | 0.372 |
| Bin UO     | x                                       | 0.362 | 0.360 | 0.344 | 0.346 |
|            | y                                       | 0.372 | 0.357 | 0.344 | 0.359 |
| Bin UP     | x                                       | 0.360 | 0.357 | 0.343 | 0.344 |
|            | y                                       | 0.357 | 0.342 | 0.311 | 0.344 |
| Bin VM     | x                                       | 0.329 | 0.329 | 0.348 | 0.347 |
|            | y                                       | 0.357 | 0.369 | 0.385 | 0.372 |
| Bin VN     | x                                       | 0.329 | 0.329 | 0.347 | 0.346 |
|            | y                                       | 0.345 | 0.357 | 0.372 | 0.359 |
| Bin VO     | x                                       | 0.329 | 0.329 | 0.346 | 0.344 |
|            | y                                       | 0.331 | 0.345 | 0.359 | 0.344 |
| Bin VP     | x                                       | 0.329 | 0.344 | 0.343 | 0.329 |
|            | y                                       | 0.331 | 0.344 | 0.331 | 0.320 |
| Bin WM     | x                                       | 0.329 | 0.329 | 0.315 | 0.314 |
|            | y                                       | 0.369 | 0.357 | 0.344 | 0.355 |
| Bin WN     | x                                       | 0.329 | 0.316 | 0.315 | 0.329 |
|            | y                                       | 0.345 | 0.333 | 0.344 | 0.357 |
| Bin WO     | x                                       | 0.329 | 0.329 | 0.317 | 0.316 |
|            | y                                       | 0.345 | 0.331 | 0.320 | 0.333 |
| Bin WP     | x                                       | 0.329 | 0.329 | 0.318 | 0.317 |
|            | y                                       | 0.331 | 0.320 | 0.310 | 0.320 |
| Bin WQ     | x                                       | 0.329 | 0.329 | 0.319 | 0.318 |
|            | y                                       | 0.320 | 0.310 | 0.300 | 0.310 |
| Bin XM     | x                                       | 0.301 | 0.314 | 0.315 | 0.303 |
|            | y                                       | 0.342 | 0.355 | 0.344 | 0.333 |
| Bin XN     | x                                       | 0.305 | 0.303 | 0.315 | 0.316 |
|            | y                                       | 0.322 | 0.333 | 0.344 | 0.333 |
| Bin XO     | x                                       | 0.308 | 0.305 | 0.316 | 0.317 |
|            | y                                       | 0.311 | 0.322 | 0.333 | 0.320 |
| Bin XP     | x                                       | 0.308 | 0.317 | 0.319 | 0.311 |
|            | y                                       | 0.311 | 0.320 | 0.300 | 0.293 |
| Bin YO     | x                                       | 0.308 | 0.283 | 0.274 | 0.303 |
|            | y                                       | 0.311 | 0.284 | 0.301 | 0.333 |
| Bin YA     | x                                       | 0.308 | 0.311 | 0.290 | 0.283 |
|            | y                                       | 0.311 | 0.293 | 0.270 | 0.284 |

Tolerance:  $\pm 0.01$ 

| Warm White | Color Limits (Chromaticity Coordinates) |       |       |       |       |
|------------|---|-------|-------|-------|-------|
| Bin MM     | x                                       | 0.471 | 0.460 | 0.473 | 0.486 |
|            | y                                       | 0.451 | 0.430 | 0.432 | 0.455 |
| Bin M1     | x                                       | 0.460 | 0.453 | 0.467 | 0.473 |
|            | y                                       | 0.430 | 0.416 | 0.419 | 0.432 |
| Bin M0     | x                                       | 0.453 | 0.444 | 0.459 | 0.467 |
|            | y                                       | 0.416 | 0.399 | 0.403 | 0.419 |
| Bin MA     | x                                       | 0.459 | 0.444 | 0.436 | 0.451 |
|            | y                                       | 0.403 | 0.399 | 0.384 | 0.389 |
| Bin NM     | x                                       | 0.454 | 0.444 | 0.460 | 0.471 |
|            | y                                       | 0.446 | 0.426 | 0.430 | 0.451 |
| Bin N1     | x                                       | 0.444 | 0.438 | 0.453 | 0.460 |
|            | y                                       | 0.426 | 0.412 | 0.416 | 0.430 |
| Bin N0     | x                                       | 0.438 | 0.429 | 0.444 | 0.453 |
|            | y                                       | 0.412 | 0.394 | 0.399 | 0.416 |
| Bin NA     | x                                       | 0.444 | 0.429 | 0.422 | 0.436 |
|            | y                                       | 0.399 | 0.394 | 0.379 | 0.384 |
| Bin PM     | x                                       | 0.438 | 0.430 | 0.444 | 0.454 |
|            | y                                       | 0.440 | 0.421 | 0.426 | 0.446 |
| Bin P1     | x                                       | 0.430 | 0.424 | 0.438 | 0.444 |
|            | y                                       | 0.421 | 0.407 | 0.412 | 0.426 |
| Bin P0     | x                                       | 0.424 | 0.416 | 0.429 | 0.438 |
|            | y                                       | 0.407 | 0.389 | 0.394 | 0.412 |
| Bin PA     | x                                       | 0.429 | 0.416 | 0.410 | 0.422 |
|            | y                                       | 0.394 | 0.389 | 0.374 | 0.379 |
| Bin QM     | x                                       | 0.421 | 0.414 | 0.430 | 0.438 |
|            | y                                       | 0.433 | 0.414 | 0.421 | 0.440 |
| Bin Q1     | x                                       | 0.414 | 0.409 | 0.424 | 0.430 |
|            | y                                       | 0.414 | 0.400 | 0.407 | 0.421 |
| Bin Q0     | x                                       | 0.409 | 0.402 | 0.416 | 0.424 |
|            | y                                       | 0.400 | 0.382 | 0.389 | 0.407 |
| Bin QA     | x                                       | 0.416 | 0.402 | 0.396 | 0.410 |
|            | y                                       | 0.389 | 0.382 | 0.367 | 0.374 |

Tolerance:  $\pm 0.01$

| Neutral White | Color Limits (Chromaticity Coordinates) |       |       |       |       |
|---------------|---|-------|-------|-------|-------|
|               |   | x     | y     | z     | w     |
| Bin RM        | x                                       | 0.421 | 0.414 | 0.397 | 0.402 |
|               | y                                       | 0.433 | 0.414 | 0.406 | 0.423 |
| Bin R1        | x                                       | 0.414 | 0.409 | 0.392 | 0.397 |
|               | y                                       | 0.414 | 0.400 | 0.391 | 0.406 |
| Bin R0        | x                                       | 0.392 | 0.387 | 0.402 | 0.409 |
|               | y                                       | 0.391 | 0.374 | 0.382 | 0.400 |
| Bin RA        | x                                       | 0.387 | 0.383 | 0.396 | 0.402 |
|               | y                                       | 0.374 | 0.360 | 0.367 | 0.382 |
| Bin SM        | x                                       | 0.402 | 0.397 | 0.382 | 0.386 |
|               | y                                       | 0.423 | 0.406 | 0.397 | 0.413 |
| Bin S1        | x                                       | 0.397 | 0.392 | 0.378 | 0.382 |
|               | y                                       | 0.406 | 0.391 | 0.382 | 0.397 |
| Bin S0        | x                                       | 0.392 | 0.387 | 0.374 | 0.378 |
|               | y                                       | 0.391 | 0.374 | 0.366 | 0.382 |
| Bin SA        | x                                       | 0.387 | 0.383 | 0.370 | 0.374 |
|               | y                                       | 0.374 | 0.360 | 0.351 | 0.366 |
| Bin TM        | x                                       | 0.386 | 0.382 | 0.365 | 0.367 |
|               | y                                       | 0.413 | 0.397 | 0.386 | 0.400 |
| Bin TN        | x                                       | 0.382 | 0.378 | 0.362 | 0.365 |
|               | y                                       | 0.397 | 0.382 | 0.372 | 0.386 |
| Bin T0        | x                                       | 0.378 | 0.374 | 0.360 | 0.362 |
|               | y                                       | 0.382 | 0.366 | 0.357 | 0.372 |
| Bin TP        | x                                       | 0.374 | 0.370 | 0.357 | 0.360 |
|               | y                                       | 0.366 | 0.351 | 0.342 | 0.357 |

Tolerance:  $\pm 0.01$ **Packaging Option (x<sub>7</sub>)**

| Selection | Option        |
|-----------|---------------|
| 1         | Tape and Reel |

| Color | Bin ID | Dominant Wavelength (nm) at 350 mA |       |
|-------|--------|------------------------------------|-------|
|       |        | Min.                               | Max.  |
| Red   | —      | 620.0                              | 635.0 |
| Amber | B      | 587.0                              | 589.5 |
|       | C      | 589.5                              | 592.0 |
|       | D      | 592.0                              | 594.5 |
|       | E      | 594.5                              | 597.0 |
| Blue  | A      | 455.0                              | 460.0 |
|       | B      | 460.0                              | 465.0 |
|       | C      | 465.0                              | 470.0 |
|       | D      | 470.0                              | 475.0 |
| Cyan  | C      | 490.0                              | 495.0 |
|       | D      | 495.0                              | 500.0 |
|       | E      | 500.0                              | 505.0 |
|       | F      | 505.0                              | 510.0 |
|       | G      | 510.0                              | 515.0 |
|       | H      | 515.0                              | 520.0 |
| Green | A      | 515.0                              | 520.0 |
|       | B      | 520.0                              | 525.0 |
|       | C      | 525.0                              | 530.0 |
|       | D      | 530.0                              | 535.0 |

Tolerance:  $\pm 1$  nm

| Color      | Bin ID | Peak Wavelength (nm) at 350 mA |       |
|------------|--------|--------------------------------|-------|
|            |        | Min.                           | Max.  |
| Royal Blue | C      | 440.0                          | 445.0 |
|            | D      | 445.0                          | 450.0 |
|            | E      | 450.0                          | 455.0 |
|            | F      | 455.0                          | 460.0 |

Tolerance:  $\pm 2$  nm

---

## Example

### ASMT-JY11-NVW01

- ASMT-JY11-Nxxxx – Warm White, InGaN, Electrically isolated Heat Sink
- $X_4 = V$  – Minimum Flux Bin V
- $X_5 = W$  – Maximum Flux Bin W
- $X_6 = 0$  – Full Distribution
- $X_7 = 1$  – Tape and Reel Option

# AlInGaP

Figure 5 Relative Intensity vs. Wavelength for Red and Amber



Figure 6 Relative Luminous Flux vs. Mono Pulse Current

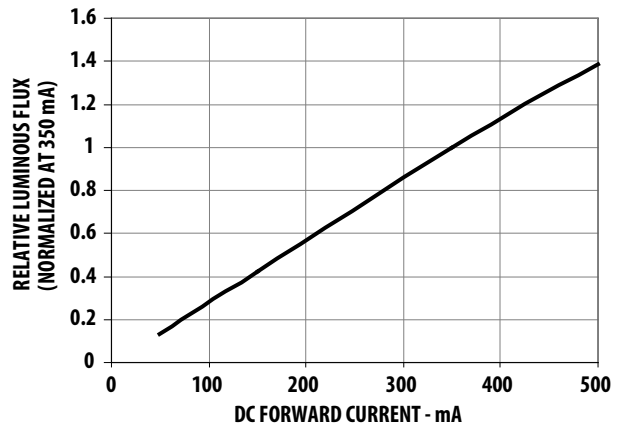


Figure 7 Forward Current vs. Forward Voltage



Figure 8 Radiation Pattern for Red and Amber

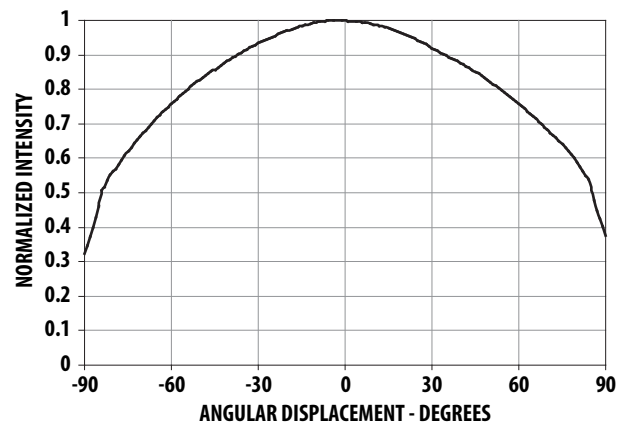


Figure 9 Maximum Pulse Current vs. Ambient Temperature. Derated based on  $T_A = 25^\circ\text{C}$ ,  $R_{\theta J-A} = 50^\circ\text{C/W}$ .

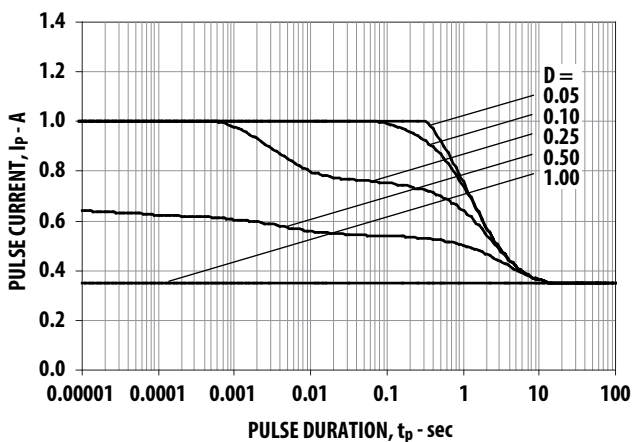
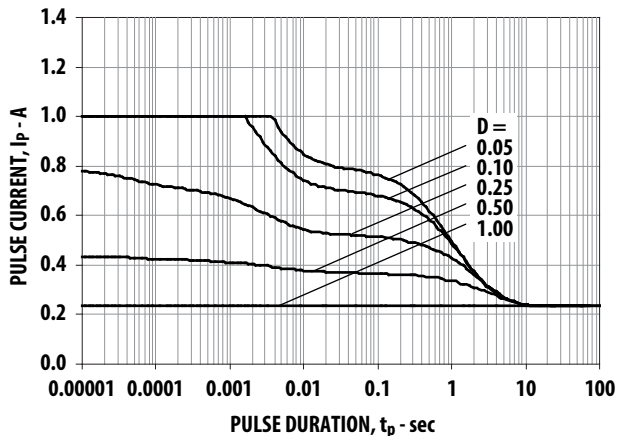


Figure 10 Maximum Pulse Current vs. Ambient Temperature. Derated based on  $T_A = 85^\circ\text{C}$ ,  $R_{\theta J-A} = 50^\circ\text{C/W}$ .



# AllnGaP

Figure 11 Relative Light Output vs. Junction Temperature



Figure 12 Forward Voltage Shift vs. Junction Temperature



Figure 13 Maximum Forward Current vs. Ambient Temperature. Derated based on  $T_{JMAX} = 125^\circ\text{C}$ ,  $R_{\theta J-A} = 30^\circ\text{C/W}$ ,  $40^\circ\text{C/W}$ , and  $50^\circ\text{C/W}$ .

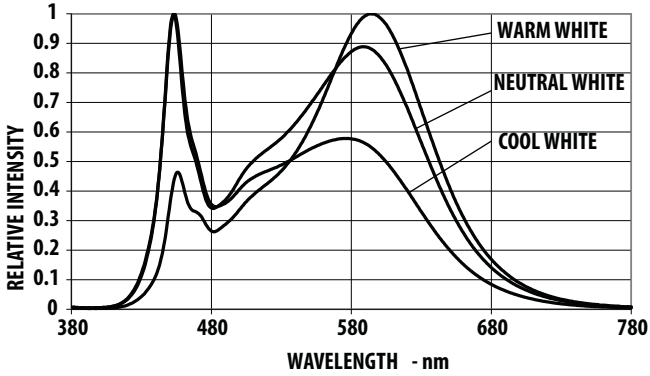


Figure 14 Maximum Forward Current vs. Metal Slug Temperature. Derated based on  $T_{JMAX} = 125^\circ\text{C}$ ,  $R_{\theta J-MS} = 9^\circ\text{C/W}$ .

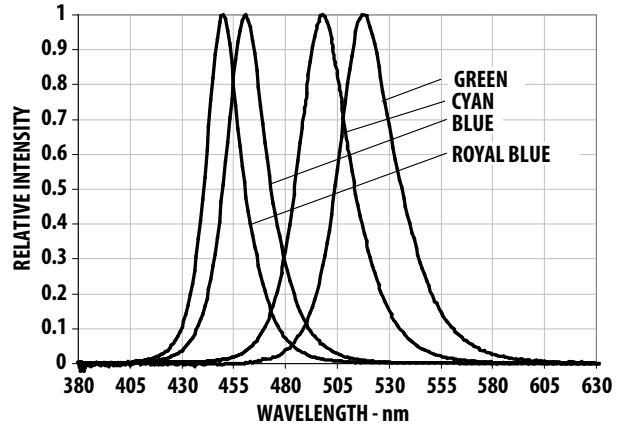


# InGaN

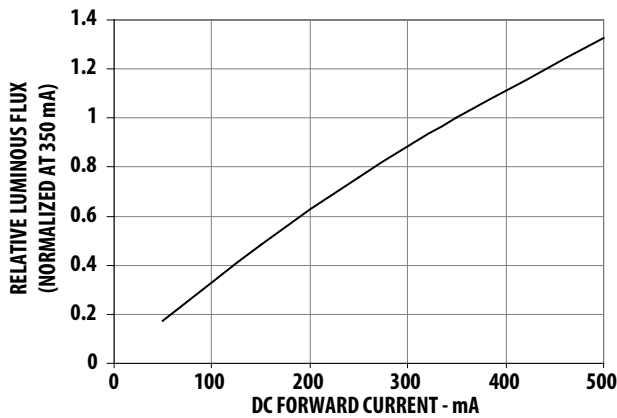
**Figure 15 Relative Intensity vs. Wavelength for Cool, Neutral, and Warm White**



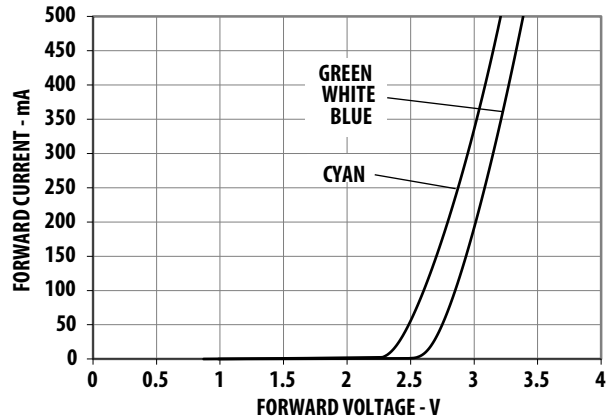
**Figure 16 Relative Intensity vs. Wavelength for Blue, Royal Blue, Cyan, and Green**



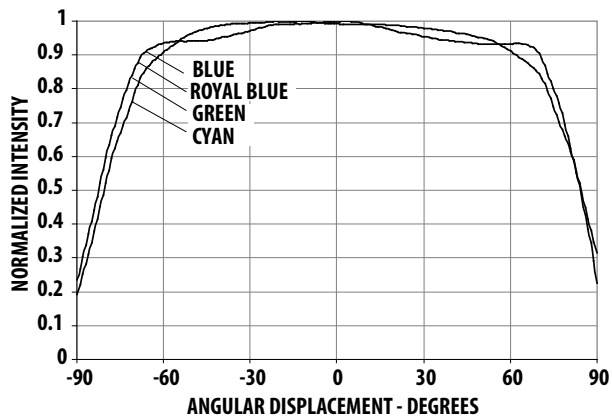
**Figure 17 Relative Luminous Flux vs. Mono Pulse Current**



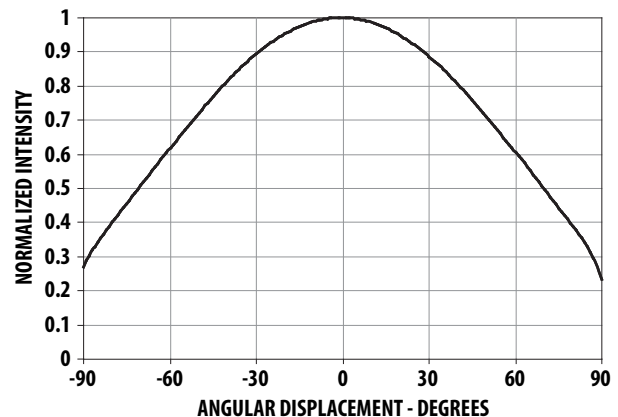
**Figure 18 Forward Current vs. Forward Voltage**



**Figure 19 Radiation Pattern for Blue, Royal Blue, Cyan, and Green**

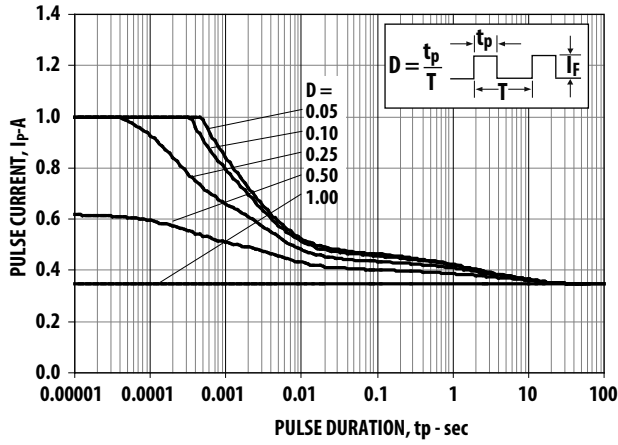


**Figure 20 Radiation Pattern for Cool White, Neutral White, and Warm White**

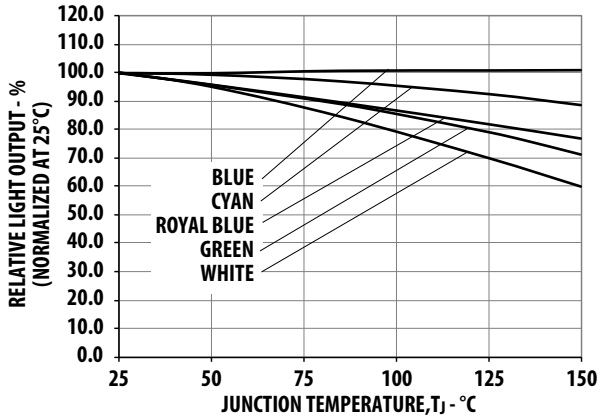


# InGaN

**Figure 21 Maximum Pulse Current vs. Ambient Temperature.**  
Derated based on  $T_A = 25^\circ\text{C}$ ,  $R_{\theta J-A} = 50^\circ\text{C/W}$ .



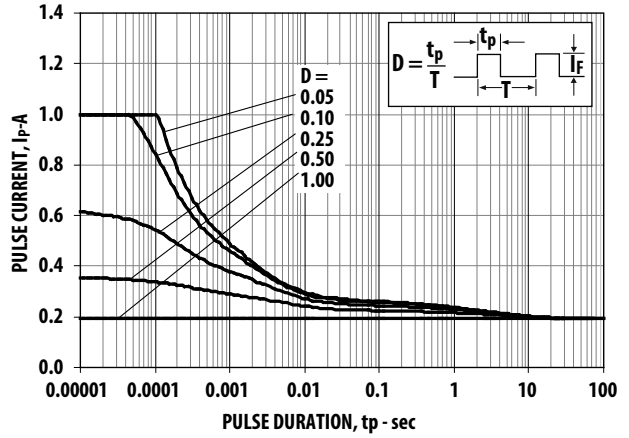
**Figure 23 Relative Light Output vs. Junction Temperature**



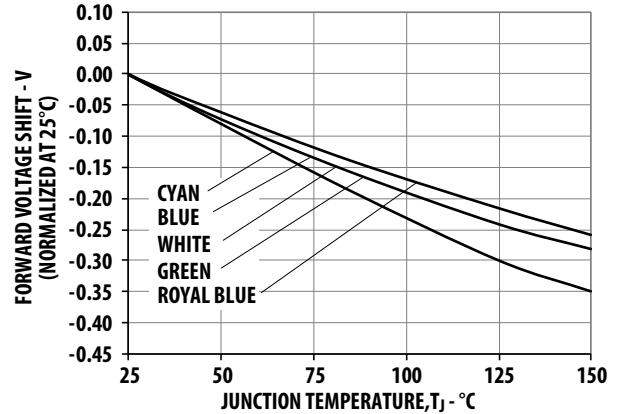
**Figure 25 Maximum Forward Current vs. Ambient Temperature.**  
Derated based on  $T_{JMAX} = 150^\circ\text{C}$ ,  $R_{\theta J-A} = 30^\circ\text{C/W}$ ,  $40^\circ\text{C/W}$  and  $50^\circ\text{C/W}$ .



**Figure 22 Maximum Pulse Current vs. Ambient Temperature.**  
Derated based on  $T_A = 85^\circ\text{C}$ ,  $R_{\theta J-A} = 50^\circ\text{C/W}$ .



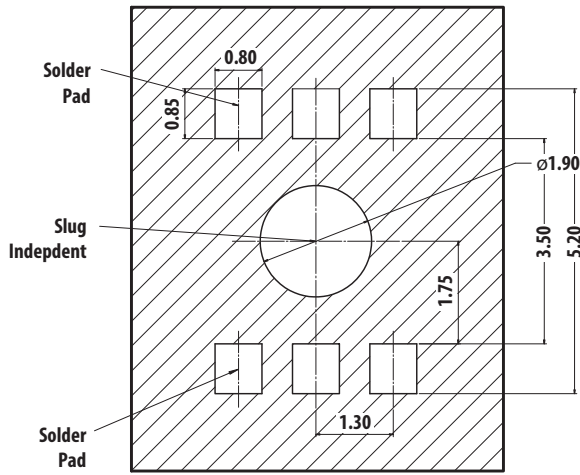
**Figure 24 Forward Voltage Shift vs. Junction Temperature**



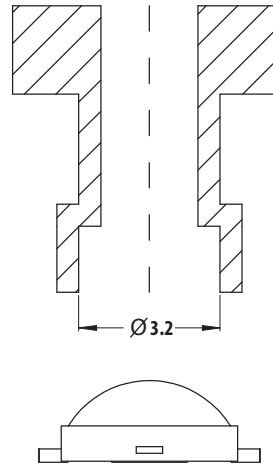
**Figure 26 Maximum Forward Current vs. Metal Slug Temperature.**  
Derated based on  $T_{JMAX} = 150^\circ\text{C}$ ,  $R_{\theta J-MS} = 9^\circ\text{C/W}$ .



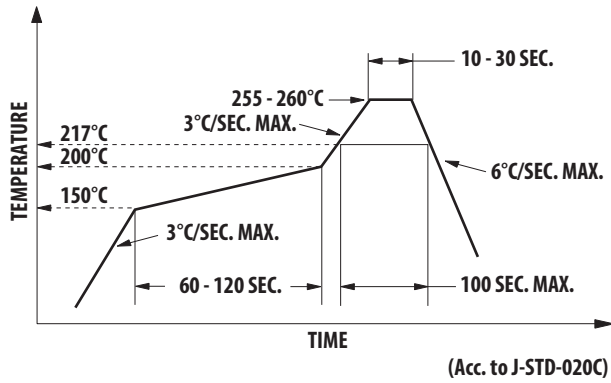
**Figure 27 Recommended Soldering Land Pattern**



**Figure 28 Recommended Pick and Place Nozzle Tip. Inner diameter = 3.2 mm.**



**Figure 29 Recommended Soldering Profile**



**NOTE** For detailed information on reflow soldering of Broadcom surface-mount LEDs, refer to Broadcom Application Note AN1060, *Surface Mounting SMT LED Indicator Components*.



# Tape and Reel – Option 1

Figure 30 Carrier Tape Dimensions



**NOTE** All dimensions are in millimeters.

**Figure 31 Reel Dimensions****NOTE**

1. Empty component pockets sealed with top cover tape.
2. 250 or 500 pieces per reel.
3. Drawing not to scale.
4. All dimensions are in millimeters.

**Figure 32 Reeling Orientation**

**DISCLAIMER:** Broadcom's products and software are not specifically designed, manufactured, or authorized for sale as parts, components, or assemblies for the planning, construction, maintenance, or direct operation of a nuclear facility or for use in medical devices or applications. The customer is solely responsible, and waives all rights to make claims against Broadcom or its suppliers, for all loss, damage, expense, or liability in connection with such use.

---

For product information and a complete list of distributors, please go to our web site: [www.broadcom.com](http://www.broadcom.com).

Broadcom, the pulse logo, Connecting everything, Avago Technologies, Avago, and the A logo are among the trademarks of Broadcom and/or its affiliates in the United States, certain other countries and/or the EU.

Copyright © 2015–2017 by Broadcom. All Rights Reserved.

The term "Broadcom" refers to Broadcom Limited and/or its subsidiaries. For more information, please visit [www.broadcom.com](http://www.broadcom.com).

Broadcom reserves the right to make changes without further notice to any products or data herein to improve reliability, function, or design.

Information furnished by Broadcom is believed to be accurate and reliable. However, Broadcom does not assume any liability arising out of the application or use of this information, nor the application or use of any product or circuit described herein, neither does it convey any license under its patent rights nor the rights of others.

AV02-1770EN – May 5, 2017



## Данный компонент на территории Российской Федерации

### Вы можете приобрести в компании MosChip.

Для оперативного оформления запроса Вам необходимо перейти по данной ссылке:

<http://moschip.ru/get-element>

Вы можете разместить у нас заказ для любого Вашего проекта, будь то серийное производство или разработка единичного прибора.

В нашем ассортименте представлены ведущие мировые производители активных и пассивных электронных компонентов.

Нашей специализацией является поставка электронной компонентной базы двойного назначения, продукции таких производителей как XILINX, Intel (ex.ALTERA), Vicor, Microchip, Texas Instruments, Analog Devices, Mini-Circuits, Amphenol, Glenair.

Сотрудничество с глобальными дистрибьюторами электронных компонентов, предоставляет возможность заказывать и получать с международных складов практически любой перечень компонентов в оптимальные для Вас сроки.

На всех этапах разработки и производства наши партнеры могут получить квалифицированную поддержку опытных инженеров.

Система менеджмента качества компании отвечает требованиям в соответствии с ГОСТ Р ИСО 9001, ГОСТ РВ 0015-002 и ЭС РД 009

### Офис по работе с юридическими лицами:

105318, г.Москва, ул.Щербаковская д.3, офис 1107, 1118, ДЦ «Щербаковский»

Телефон: +7 495 668-12-70 (многоканальный)

Факс: +7 495 668-12-70 (доб.304)

E-mail: [info@moschip.ru](mailto:info@moschip.ru)

Skype отдела продаж:

moschip.ru

moschip.ru\_4

moschip.ru\_6

moschip.ru\_9