

## ADA4051-1/ADA4051-2

### FEATURES

- Very low supply current: 13  $\mu$ A typical
- Low offset voltage: 15  $\mu$ V maximum
- Offset voltage drift: 20 nV/ $^{\circ}$ C
- Single-supply operation: 1.8 V to 5.5 V
- High PSRR: 110 dB minimum
- High CMRR: 110 dB minimum
- Rail-to-rail input/output
- Unity-gain stable
- Extended industrial temperature range

### APPLICATIONS

- Pressure and position sensors
- Temperature measurements
- Electronic scales
- Medical instrumentation
- Battery-powered equipment
- Handheld test equipment

### PIN CONFIGURATION

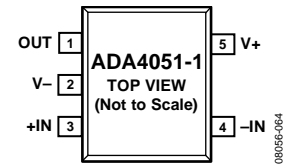

Figure 1. 5-Lead SOT-23 (RJ-5)

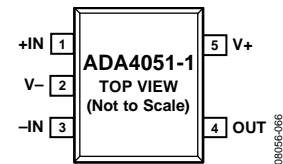
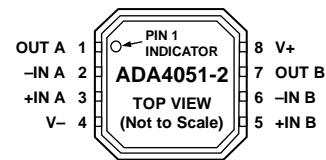

Figure 2. 5-Lead SC-70 (KS-5)



Figure 3. 8-Lead MSOP (RM-8)



NOTES  
1. IT IS RECOMMENDED THAT THE EXPOSED PAD BE CONNECTED TO V-.

Figure 4. 8-Lead LFCSP (CP-8-2)

### GENERAL DESCRIPTION

The ADA4051-1/ADA4051-2 are CMOS, micropower, zero-drift operational amplifiers utilizing an innovative chopping technique. These amplifiers feature rail-to-rail input/output swing and extremely low offset voltage while operating from a 1.8 V to 5.5 V power supply. In addition, these amplifiers offer high power supply rejection ratio (PSRR) and common-mode rejection ratio (CMRR) while operating with a typical supply current of 13  $\mu$ A per amplifier. This combination of features makes the ADA4051-1/ADA4051-2 amplifiers ideal choices for battery-powered applications where high precision and low power consumption are important.

The ADA4051-1/ADA4051-2 are specified for the extended industrial temperature range of  $-40^{\circ}$ C to  $+125^{\circ}$ C. The ADA4051-1 amplifier is available in 5-lead SOT-23 and 5-lead SC-70 packages. The ADA4051-2 amplifier is available in 8-lead MSOP and 8-lead LFCSP packages.

The ADA4051-1/ADA4051-2 are members of a growing series of zero-drift op amps offered by Analog Devices, Inc. Refer to Table 1 for a list of these devices.

Table 1. Op Amps

| Supply | Low Power, 5V | 5V     | 16V    |
|--------|---------------|--------|--------|
| Single | AD8538        | AD8628 | AD8638 |
| Dual   | AD8539        | AD8629 | AD8639 |
| Quad   |               | AD8630 |        |

### Rev. B

Information furnished by Analog Devices is believed to be accurate and reliable. However, no responsibility is assumed by Analog Devices for its use, nor for any infringements of patents or other rights of third parties that may result from its use. Specifications subject to change without notice. No license is granted by implication or otherwise under any patent or patent rights of Analog Devices. Trademarks and registered trademarks are the property of their respective owners.

## TABLE OF CONTENTS

|  |   |   |    |
|--|---|---|----|
| Features .....                                   | 1 | Thermal Resistance .....                  | 5  |
| Applications.....                                | 1 | Power Sequencing .....                    | 5  |
| Pin Configuration.....                           | 1 | ESD Caution.....                          | 5  |
| General Description .....                        | 1 | Typical Performance Characteristics ..... | 6  |
| Revision History .....                           | 2 | Theory of Operation .....                 | 15 |
| Specifications.....                              | 3 | Input Voltage Range.....                  | 16 |
| Electrical Characteristics—1.8 V Operation ..... | 3 | Output Phase Reversal.....                | 16 |
| Electrical Characteristics—5 V Operation.....    | 4 | Outline Dimensions .....                  | 17 |
| Absolute Maximum Ratings.....                    | 5 | Ordering Guide .....                      | 18 |

## REVISION HISTORY

### 1/10—Rev. A to Rev. B

|   |           |
|---|-----------|
| Added ADA4051-1, 5-Lead SC-70 Package.....  | Universal |
| Added Figure 2; Renumbered Sequentially .....                                     | 1         |
| Changes to Figure 4 and General Description Section .....                         | 1         |
| Changes to Electrical Characteristics—1.8 V Operation Section<br>and Table 2..... | 3         |
| Changes to Electrical Characteristics—5 V Operation Section<br>and Table 3.....   | 4         |
| Changes to Table 5.....   | 5         |
| Updated Outline Dimensions .....  | 17        |
| Changes to Ordering Guide .....   | 18        |

### 10/09—Rev. 0 to Rev. A

|  |           |
|--|-----------|
| Added ADA4051-1, 5-Lead SOT-23 Package.....  | Universal |
| Added ADA4051-2, 8-Lead LFCSP Package .....  | Universal |
| Changes to the Features and General Description Section,<br>Added Figure 1 and Figure 3.....     | 1         |
| Moved Electrical Characteristics—1.8 V Operation Section .....                                   | 3         |
| Changes to Offset Voltage Parameter and Supply Current per<br>Amplifier Parameter, Table 2 ..... | 3         |
| Moved Electrical Characteristics—5 V Operation Section .....                                     | 4         |
| Changes to Offset Voltage Parameter and Supply Current per<br>Amplifier Parameter, Table 2 ..... | 4         |
| Changes to Thermal Resistance Section and Table 5.....   | 5         |
| Changes to Figure 22 and Figure 25.....  | 9         |
| Changes to Theory of Operation Section.....  | 15        |
| Updated Outline Dimensions .....   | 17        |
| Changes to Ordering Guide .....  | 18        |

### 7/09—Revision 0: Initial Version

# SPECIFICATIONS

## ELECTRICAL CHARACTERISTICS—1.8 V OPERATION

$V_{SY} = 1.8\text{ V}$ ,  $V_{CM} = V_{SY}/2$ ,  $T_A = 25^\circ\text{C}$ ,  $R_L = 100\text{ k}\Omega$  to GND, unless otherwise noted.

Table 2.

| Parameter                            | Symbol                   | Test Conditions/Comments  | Min   | Typ   | Max | Unit                         |
|--------------------------------------|--------------------------|---|-------|-------|-----|------------------------------|
| <b>INPUT CHARACTERISTICS</b>         |                          |   |       |       |     |                              |
| Offset Voltage                       | $V_{OS}$                 |   |       |       |     |                              |
| ADA4051-2                            |                          | $0\text{ V} \leq V_{CM} \leq 1.8\text{ V}$  |       | 2     | 15  | $\mu\text{V}$                |
| ADA4051-1                            |                          | $0\text{ V} \leq V_{CM} \leq 1.8\text{ V}$  |       | 2     | 17  | $\mu\text{V}$                |
| Offset Voltage Drift                 | $\Delta V_{OS}/\Delta T$ | $-40^\circ\text{C} \leq T_A \leq +125^\circ\text{C}$  |       | 0.02  | 0.1 | $\mu\text{V}/^\circ\text{C}$ |
| Input Bias Current                   | $I_B$                    |   |       | 5     | 50  | $\text{pA}$                  |
|                                      |                          | $-40^\circ\text{C} \leq T_A \leq +125^\circ\text{C}$  |       |       | 200 | $\text{pA}$                  |
| Input Offset Current                 | $I_{OS}$                 |   |       | 10    | 100 | $\text{pA}$                  |
|                                      |                          | $-40^\circ\text{C} \leq T_A \leq +125^\circ\text{C}$  |       |       | 150 | $\text{pA}$                  |
| Input Voltage Range                  |                          | $-40^\circ\text{C} \leq T_A \leq +125^\circ\text{C}$  | 0     |       | 1.8 | $\text{V}$                   |
| Common-Mode Rejection Ratio          | CMRR                     | $0\text{ V} \leq V_{CM} \leq 1.8\text{ V}$  | 105   | 125   |     | $\text{dB}$                  |
|                                      |                          | $-40^\circ\text{C} \leq T_A \leq +125^\circ\text{C}$  | 100   |       |     | $\text{dB}$                  |
| Large-Signal Voltage Gain            | $A_{VO}$                 | $R_L = 10\text{ k}\Omega$ to $V_{CM}$ ,<br>$0.1\text{ V} \leq V_{OUT} \leq V_{SY} - 0.1\text{ V}$ | 106   | 130   |     | $\text{dB}$                  |
|                                      |                          | $-40^\circ\text{C} \leq T_A \leq +125^\circ\text{C}$  | 100   |       |     | $\text{dB}$                  |
| Input Resistance                     | $R_{IN}$                 |   |       | 8     |     | $\text{M}\Omega$             |
| Input Capacitance, Differential Mode | $C_{INDM}$               |   |       | 2     |     | $\text{pF}$                  |
| Input Capacitance, Common Mode       | $C_{INCM}$               |   |       | 5     |     | $\text{pF}$                  |
| <b>OUTPUT CHARACTERISTICS</b>        |                          |   |       |       |     |                              |
| Output Voltage High                  | $V_{OH}$                 | $R_L = 100\text{ k}\Omega$ to $V_{CM}$  | 1.796 | 1.799 |     | $\text{V}$                   |
|                                      |                          | $-40^\circ\text{C} \leq T_A \leq +125^\circ\text{C}$  | 1.79  |       |     | $\text{V}$                   |
|                                      |                          | $R_L = 10\text{ k}\Omega$ to $V_{CM}$   | 1.76  | 1.796 |     | $\text{V}$                   |
|                                      |                          | $-40^\circ\text{C} \leq T_A \leq +125^\circ\text{C}$  | 1.7   |       |     | $\text{V}$                   |
| Output Voltage Low                   | $V_{OL}$                 | $R_L = 100\text{ k}\Omega$ to $V_{CM}$  |       | 1     | 3   | $\text{mV}$                  |
|                                      |                          | $-40^\circ\text{C} \leq T_A \leq +125^\circ\text{C}$  |       |       | 9   | $\text{mV}$                  |
|                                      |                          | $R_L = 10\text{ k}\Omega$ to $V_{CM}$   |       | 3     | 20  | $\text{mV}$                  |
|                                      |                          | $-40^\circ\text{C} \leq T_A \leq +125^\circ\text{C}$  |       |       | 40  | $\text{mV}$                  |
| Short-Circuit Current                | $I_{SC}$                 | $V_{OUT} = V_{SY}$ or GND   |       | 13    |     | $\text{mA}$                  |
| Closed-Loop Output Impedance         | $Z_{OUT}$                | $f = 1\text{ kHz}$ , $G = 10$   |       | 1     |     | $\Omega$                     |
| <b>POWER SUPPLY</b>                  |                          |   |       |       |     |                              |
| Power Supply Rejection Ratio         | PSRR                     | $1.8\text{ V} \leq V_{SY} \leq 5.5\text{ V}$  | 110   | 135   |     | $\text{dB}$                  |
|                                      |                          | $-40^\circ\text{C} \leq T_A \leq +125^\circ\text{C}$  | 106   |       |     | $\text{dB}$                  |
| Supply Current per Amplifier         | $I_{SY}$                 |   |       |       |     |                              |
| ADA4051-2                            |                          | $V_{OUT} = V_{SY}/2$  |       | 13    | 17  | $\mu\text{A}$                |
| ADA4051-1                            |                          | $V_{OUT} = V_{SY}/2$  |       | 15    | 18  | $\mu\text{A}$                |
|                                      |                          | $-40^\circ\text{C} \leq T_A \leq +125^\circ\text{C}$  |       |       | 20  | $\mu\text{A}$                |
| <b>DYNAMIC PERFORMANCE</b>           |                          |   |       |       |     |                              |
| Slew Rate                            | SR+                      | $R_L = 10\text{ k}\Omega$ , $C_L = 100\text{ pF}$ , $G = 1$                                       |       | 0.04  |     | $\text{V}/\mu\text{s}$       |
|                                      | SR-                      | $R_L = 10\text{ k}\Omega$ , $C_L = 100\text{ pF}$ , $G = 1$                                       |       | 0.03  |     | $\text{V}/\mu\text{s}$       |
| Settling Time                        | $t_s$                    | To 0.1%, $V_{IN} = 1\text{ V p-p}$ ,<br>$R_L = 10\text{ k}\Omega$ , $C_L = 100\text{ pF}$         |       | 120   |     | $\mu\text{s}$                |
| Gain Bandwidth Product               | GBP                      | $C_L = 100\text{ pF}$ , $G = 1$   |       | 115   |     | $\text{kHz}$                 |
| Phase Margin                         | $\Phi_M$                 | $C_L = 100\text{ pF}$ , $G = 1$   |       | 40    |     | Degrees                      |
| Channel Separation                   | CS                       | $V_{IN} = 1.7\text{ V}$ , $f = 100\text{ Hz}$   |       | 140   |     | $\text{dB}$                  |
| <b>NOISE PERFORMANCE</b>             |                          |   |       |       |     |                              |
| Voltage Noise                        | $e_n$ p-p                | $f = 0.1\text{ Hz}$ to $10\text{ Hz}$   |       | 1.96  |     | $\mu\text{V p-p}$            |
| Voltage Noise Density                | $e_n$                    | $f = 1\text{ kHz}$  |       | 95    |     | $\text{nV}/\sqrt{\text{Hz}}$ |
| Current Noise Density                | $i_n$                    | $f = 1\text{ kHz}$  |       | 100   |     | $\text{fA}/\sqrt{\text{Hz}}$ |

# ADA4051-1/ADA4051-2

## ELECTRICAL CHARACTERISTICS—5 V OPERATION

$V_{SY} = 5.0\text{ V}$ ,  $V_{CM} = V_{SY}/2\text{ V}$ ,  $T_A = 25^\circ\text{C}$ ,  $R_L = 100\text{ k}\Omega$  to GND, unless otherwise noted.

Table 3.

| Parameter                            | Symbol                   | Test Conditions/Comments  | Min   | Typ   | Max | Unit                         |
|--------------------------------------|--------------------------|---|-------|-------|-----|------------------------------|
| <b>INPUT CHARACTERISTICS</b>         |                          |   |       |       |     |                              |
| Offset Voltage                       | $V_{OS}$                 | $0\text{ V} \leq V_{CM} \leq 5\text{ V}$  |       | 2     | 15  | $\mu\text{V}$                |
| ADA4051-2                            |                          | $0\text{ V} \leq V_{CM} \leq 5\text{ V}$  |       | 2     | 17  | $\mu\text{V}$                |
| ADA4051-1                            |                          | $0\text{ V} \leq V_{CM} \leq 5\text{ V}$  |       | 0.02  | 0.1 | $\mu\text{V}/^\circ\text{C}$ |
| Offset Voltage Drift                 | $\Delta V_{OS}/\Delta T$ | $-40^\circ\text{C} \leq T_A \leq +125^\circ\text{C}$  |       | 20    | 70  | pA                           |
| Input Bias Current                   | $I_B$                    | $-40^\circ\text{C} \leq T_A \leq +125^\circ\text{C}$  |       |       | 200 | pA                           |
| Input Offset Current                 | $I_{OS}$                 | $-40^\circ\text{C} \leq T_A \leq +125^\circ\text{C}$  |       | 40    | 100 | pA                           |
| Input Voltage Range                  |                          | $-40^\circ\text{C} \leq T_A \leq +125^\circ\text{C}$  | 0     |       | 150 | pA                           |
| Common-Mode Rejection Ratio          | CMRR                     | $0\text{ V} \leq V_{CM} \leq 5\text{ V}$  | 110   | 135   | 5   | V                            |
|                                      |                          | $-40^\circ\text{C} \leq T_A \leq +125^\circ\text{C}$  | 106   |       |     | dB                           |
| Large-Signal Voltage Gain            | $A_{VO}$                 | $R_L = 10\text{ k}\Omega$ to $V_{CM}$ ,<br>$0.1\text{ V} \leq V_{OUT} \leq V_{SY} - 0.1\text{ V}$ | 115   | 135   |     | dB                           |
|                                      |                          | $-40^\circ\text{C} \leq T_A \leq +125^\circ\text{C}$  | 106   |       |     | dB                           |
| Input Resistance                     | $R_{IN}$                 |   |       | 8     |     | $\text{M}\Omega$             |
| Input Capacitance, Differential Mode | $C_{INDM}$               |   |       | 2     |     | pF                           |
| Input Capacitance, Common Mode       | $C_{INCM}$               |   |       | 5     |     | pF                           |
| <b>OUTPUT CHARACTERISTICS</b>        |                          |   |       |       |     |                              |
| Output Voltage High                  | $V_{OH}$                 | $R_L = 100\text{ k}\Omega$ to $V_{CM}$  | 4.996 | 4.998 |     | V                            |
|                                      |                          | $-40^\circ\text{C} \leq T_A \leq +125^\circ\text{C}$  | 4.985 |       |     | V                            |
|                                      |                          | $R_L = 10\text{ k}\Omega$ to $V_{CM}$   | 4.96  | 4.99  |     | V                            |
|                                      |                          | $-40^\circ\text{C} \leq T_A \leq +125^\circ\text{C}$  | 4.9   |       |     | V                            |
| Output Voltage Low                   | $V_{OL}$                 | $R_L = 100\text{ k}\Omega$ to $V_{CM}$  |       | 1     | 4   | mV                           |
|                                      |                          | $-40^\circ\text{C} \leq T_A \leq +125^\circ\text{C}$  |       |       | 13  | mV                           |
|                                      |                          | $R_L = 10\text{ k}\Omega$ to $V_{CM}$   |       | 9     | 30  | mV                           |
|                                      |                          | $-40^\circ\text{C} \leq T_A \leq +125^\circ\text{C}$  |       |       | 90  | mV                           |
| Short-Circuit Current                | $I_{SC}$                 | $V_{OUT} = V_{SY}$ or GND   |       | 15    |     | mA                           |
| Closed-Loop Output Impedance         | $Z_{OUT}$                | $f = 1\text{ kHz}$ , $G = 10$   |       | 1     |     | $\Omega$                     |
| <b>POWER SUPPLY</b>                  |                          |   |       |       |     |                              |
| Power Supply Rejection Ratio         | PSRR                     | $1.8\text{ V} \leq V_{SY} \leq 5.5\text{ V}$  | 110   | 135   |     | dB                           |
|                                      |                          | $-40^\circ\text{C} \leq T_A \leq +125^\circ\text{C}$  | 106   |       |     | dB                           |
| Supply Current per Amplifier         | $I_{SY}$                 | $V_{OUT} = V_{SY}/2$  |       | 13    | 17  | $\mu\text{A}$                |
| ADA4051-2                            |                          | $V_{OUT} = V_{SY}/2$  |       | 15    | 18  | $\mu\text{A}$                |
| ADA4051-1                            |                          | $-40^\circ\text{C} \leq T_A \leq +125^\circ\text{C}$  |       |       | 20  | $\mu\text{A}$                |
| <b>DYNAMIC PERFORMANCE</b>           |                          |   |       |       |     |                              |
| Slew Rate                            | SR+                      | $R_L = 10\text{ k}\Omega$ , $C_L = 100\text{ pF}$ , $G = 1$                                       |       | 0.06  |     | $\text{V}/\mu\text{s}$       |
|                                      | SR-                      | $R_L = 10\text{ k}\Omega$ , $C_L = 100\text{ pF}$ , $G = 1$                                       |       | 0.04  |     | $\text{V}/\mu\text{s}$       |
| Settling Time                        | $t_s$                    | To 0.1%, $V_{IN} = 1\text{ V p-p}$ ,<br>$R_L = 10\text{ k}\Omega$ , $C_L = 100\text{ pF}$         |       | 110   |     | $\mu\text{s}$                |
| Gain Bandwidth Product               | GBP                      | $C_L = 100\text{ pF}$ , $G = 1$   |       | 125   |     | kHz                          |
| Phase Margin                         | $\Phi_M$                 | $C_L = 100\text{ pF}$ , $G = 1$   |       | 40    |     | Degrees                      |
| Channel Separation                   | CS                       | $V_{IN} = 4.99\text{ V}$ , $f = 100\text{ Hz}$  |       | 140   |     | dB                           |
| <b>NOISE PERFORMANCE</b>             |                          |   |       |       |     |                              |
| Voltage Noise                        | $e_n\text{ p-p}$         | $f = 0.1\text{ Hz}$ to $10\text{ Hz}$   |       | 1.96  |     | $\mu\text{V p-p}$            |
| Voltage Noise Density                | $e_n$                    | $f = 1\text{ kHz}$  |       | 95    |     | $\text{nV}/\sqrt{\text{Hz}}$ |
| Current Noise Density                | $i_n$                    | $f = 1\text{ kHz}$  |       | 100   |     | $\text{fA}/\sqrt{\text{Hz}}$ |

## ABSOLUTE MAXIMUM RATINGS

Table 4.

| Parameter                               | Rating                 |
|---|------------------------|
| Supply Voltage                          | 6 V                    |
| Input Voltage                           | $\pm V_{SY} \pm 0.3$ V |
| Input Current <sup>1</sup>              | $\pm 10$ mA            |
| Differential Input Voltage <sup>2</sup> | $\pm V_{SY}$           |
| Output Short-Circuit Duration to GND    | Indefinite             |
| Storage Temperature Range               | -65°C to +150°C        |
| Operating Temperature Range             | -40°C to +125°C        |
| Junction Temperature Range              | -65°C to +150°C        |
| Lead Temperature (Soldering, 60 sec)    | 300°C                  |

<sup>1</sup> The input pins have clamp diodes to the power supply pins. Limit the input current to 10 mA or less whenever input signals exceed the power supply rail by 0.3 V.

<sup>2</sup> Inputs are protected against high differential voltages by internal series 1.33 kΩ resistors and back-to-back diode-connected N-MOSFETs (with a typical  $V_T$  of 0.7 V for  $V_{CM}$  of 0 V).

Stresses above those listed under Absolute Maximum Ratings may cause permanent damage to the device. This is a stress rating only; functional operation of the device at these or any other conditions above those indicated in the operational section of this specification is not implied. Exposure to absolute maximum rating conditions for extended periods may affect device reliability.

## THERMAL RESISTANCE

$\theta_{JA}$  is specified for the worst-case conditions, that is, a device soldered on a circuit board for surface-mount packages with its exposed paddle soldered to a pad, if applicable. Table 5 shows simulated thermal values for a 4-layer (2S2P) JEDEC standard thermal test board, unless otherwise specified.

Table 5. Thermal Resistance

| Package Type          | $\theta_{JA}$ | $\theta_{JC}$ | Unit |
|-----------------------|---------------|---------------|------|
| 5-Lead SOT-23 (RJ-5)  | 190           | 92            | °C/W |
| 5-Lead SC-70 (KS-5)   | 534           | 173           | °C/W |
| 8-Lead MSOP (RM-8)    | 142           | 45            | °C/W |
| 8-Lead LFCSP (CP-8-2) | 77            | 14            | °C/W |

## POWER SEQUENCING

The op amp supplies must be established simultaneously with or before any input signals are applied. If this is not possible, the input current must be limited to 10 mA.

## ESD CAUTION



**ESD (electrostatic discharge) sensitive device.** Charged devices and circuit boards can discharge without detection. Although this product features patented or proprietary protection circuitry, damage may occur on devices subjected to high energy ESD. Therefore, proper ESD precautions should be taken to avoid performance degradation or loss of functionality.

TYPICAL PERFORMANCE CHARACTERISTICS

T<sub>A</sub> = 25°C, unless otherwise noted.

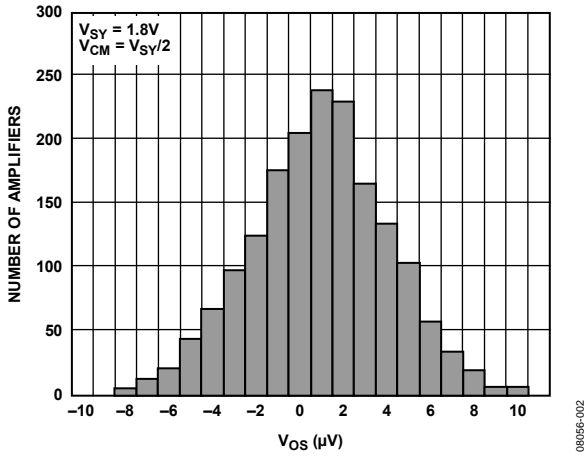

Figure 5. Input Offset Voltage Distribution

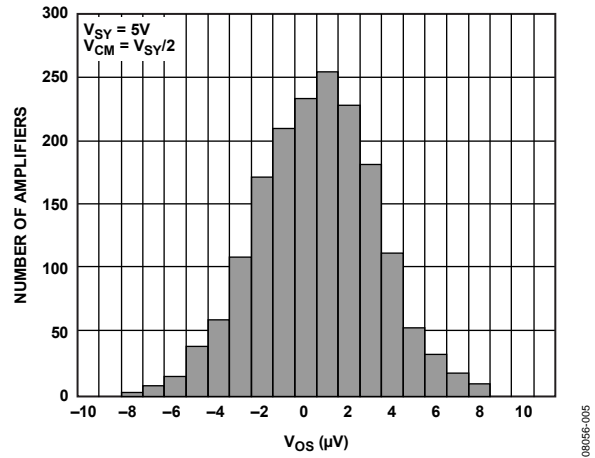

Figure 8. Input Offset Voltage Distribution

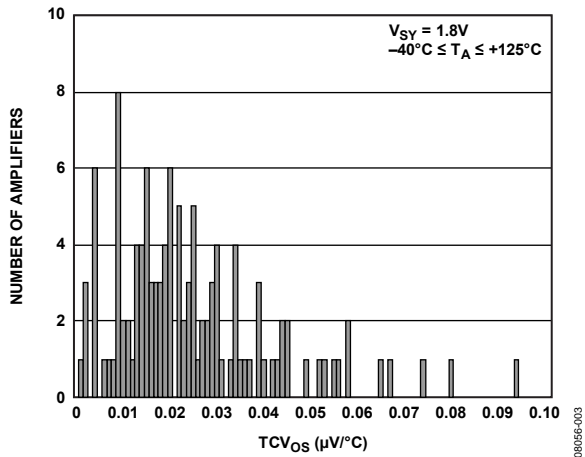

Figure 6. Input Offset Voltage Drift Distribution with Temperature

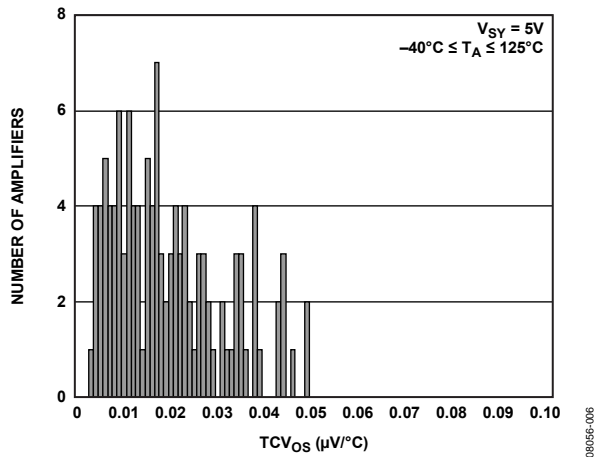

Figure 9. Input Offset Voltage Drift Distribution with Temperature

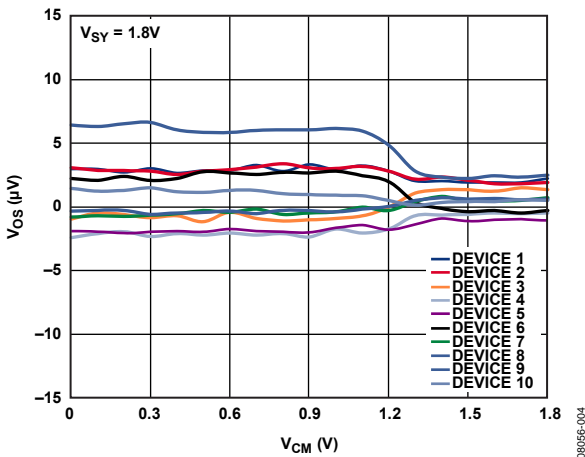

Figure 7. Input Offset Voltage vs. Input Common-Mode Voltage

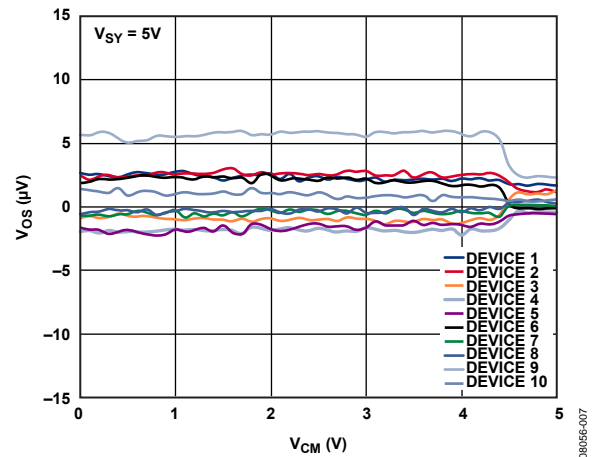

Figure 10. Input Offset Voltage vs. Input Common-Mode Voltage

T<sub>A</sub> = 25°C, unless otherwise noted.

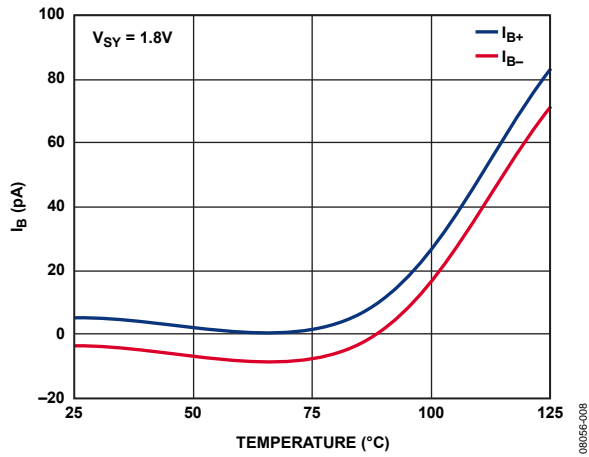

Figure 11. Input Bias Current vs. Temperature

08056-008

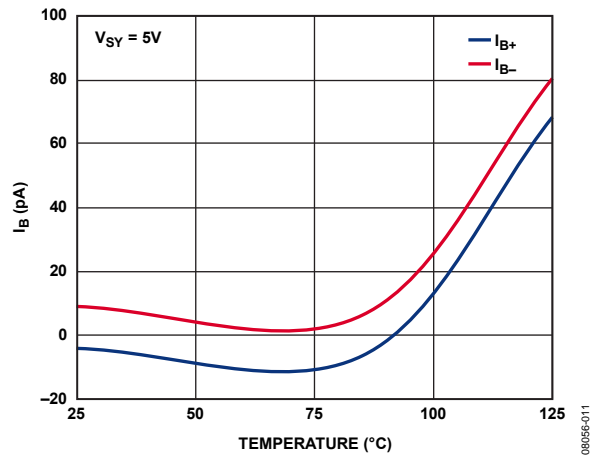

Figure 14. Input Bias Current vs. Temperature

08056-011

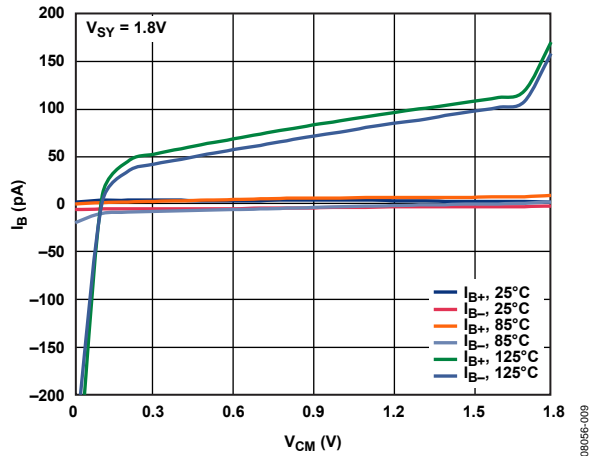

Figure 12. Input Bias Current vs. Common-Mode Voltage and Temperature

08056-009

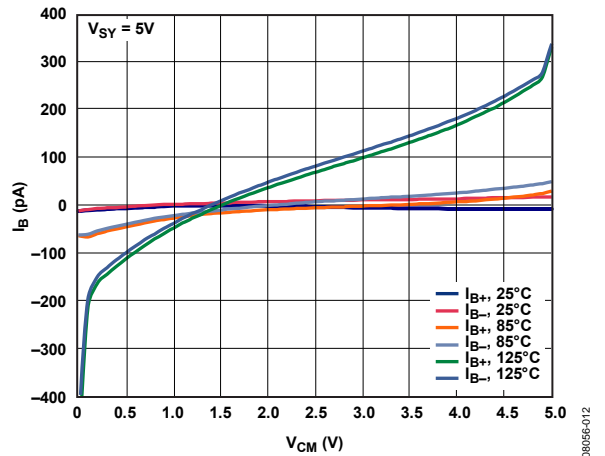

Figure 15. Input Bias Current vs. Common-Mode Voltage and Temperature

08056-012

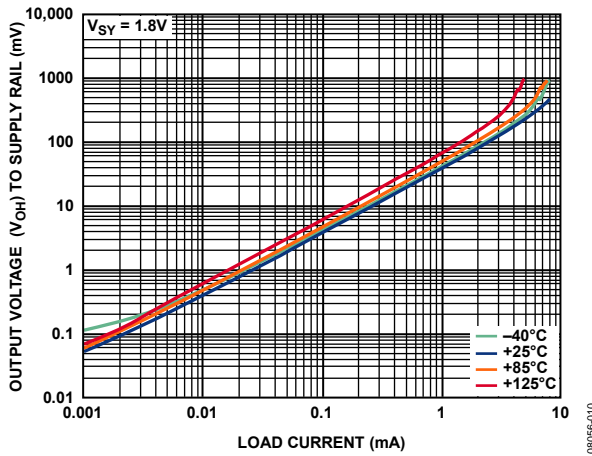

Figure 13. Output Voltage (V<sub>OH</sub>) to Supply Rail vs. Load Current and Temperature

08056-010

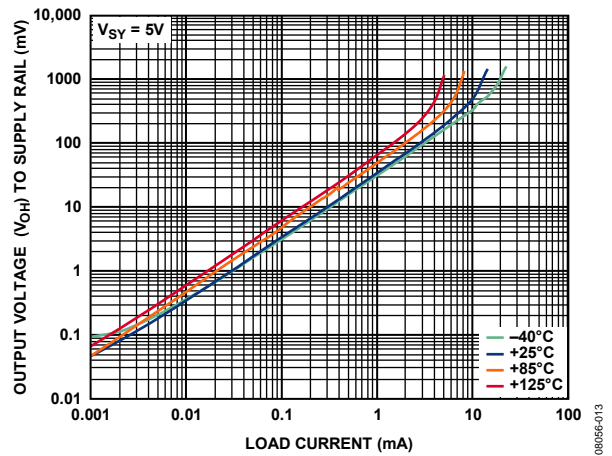

Figure 16. Output Voltage (V<sub>OH</sub>) to Supply Rail vs. Load Current and Temperature

08056-013

# ADA4051-1/ADA4051-2

$T_A = 25^\circ\text{C}$ , unless otherwise noted.

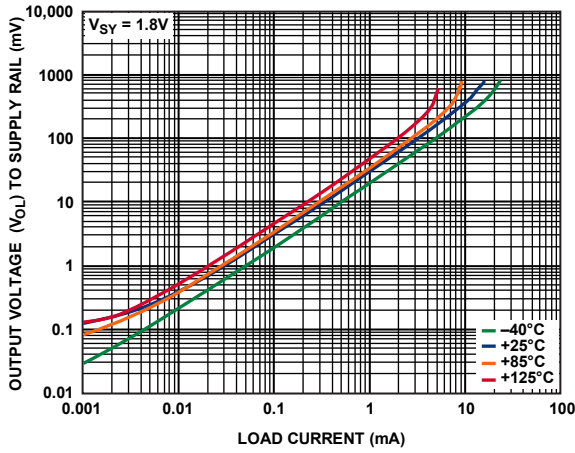

Figure 17. Output Voltage ( $V_{OL}$ ) to Supply Rail vs. Load Current and Temperature

08056-014

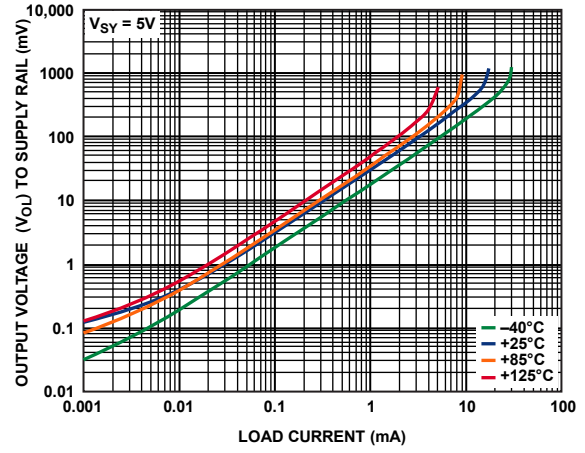

Figure 20. Output Voltage ( $V_{OL}$ ) to Supply Rail vs. Load Current and Temperature

08056-017

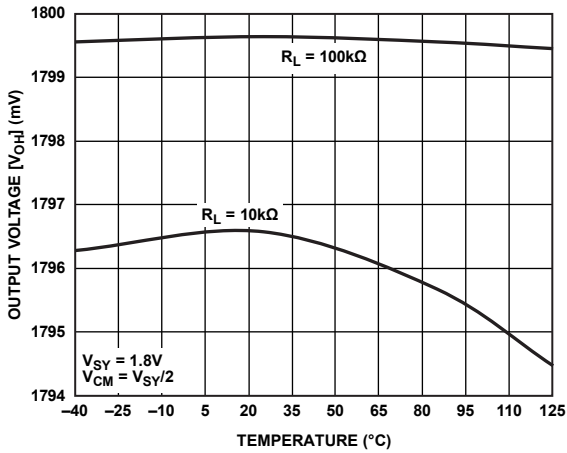

Figure 18. Output Voltage ( $V_{OH}$ ) vs. Temperature

08056-015

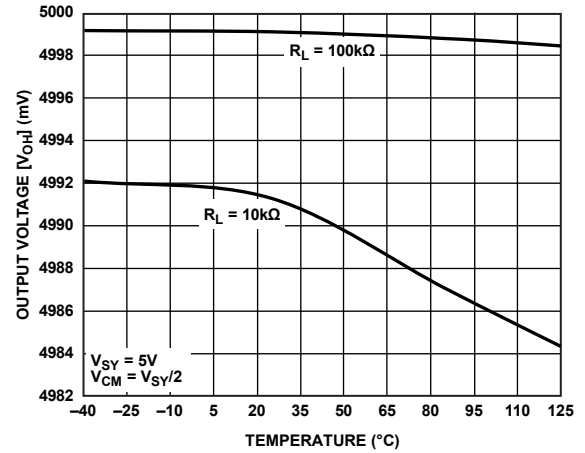

Figure 21. Output Voltage ( $V_{OH}$ ) vs. Temperature

08056-018

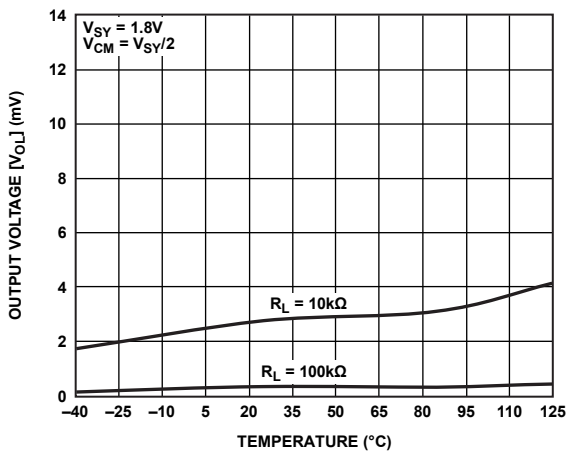

Figure 19. Output Voltage ( $V_{OL}$ ) vs. Temperature

08056-016

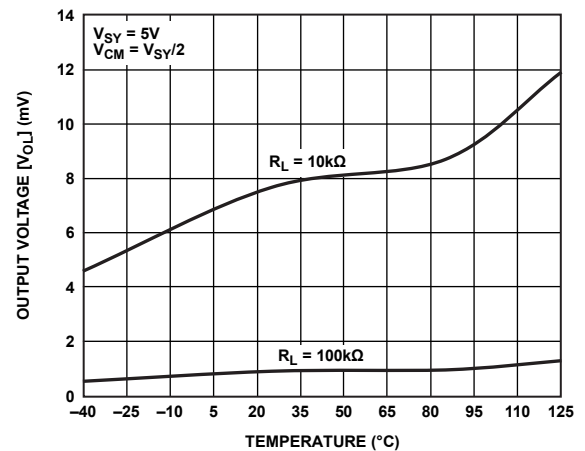

Figure 22. Output Voltage ( $V_{OL}$ ) vs. Temperature

08056-019



T<sub>A</sub> = 25°C, unless otherwise noted.

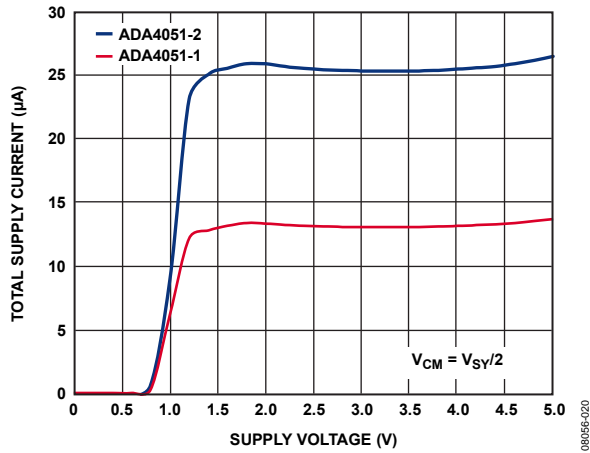

Figure 23. Total Supply Current vs. Supply Voltage

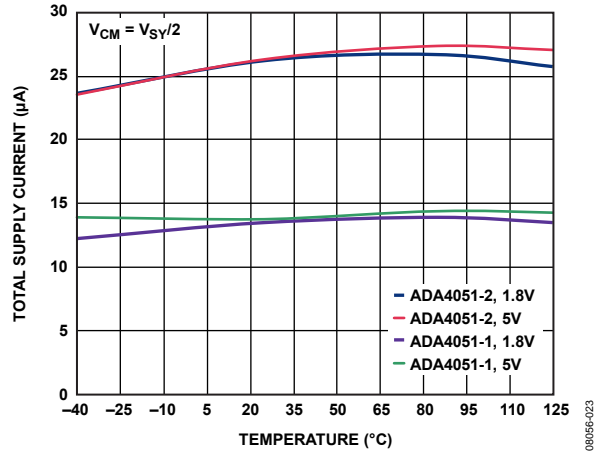

Figure 26. Total Supply Current vs. Temperature

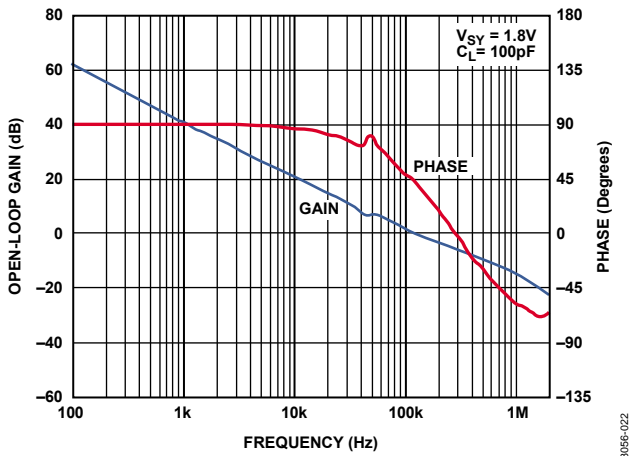

Figure 24. Open-Loop Gain and Phase vs. Frequency

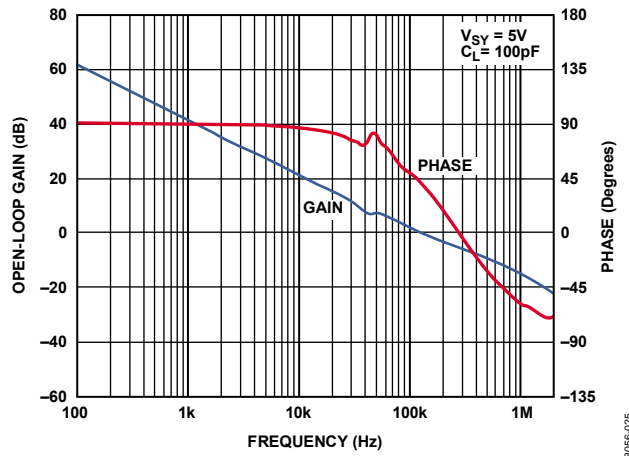

Figure 27. Open-Loop Gain and Phase vs. Frequency

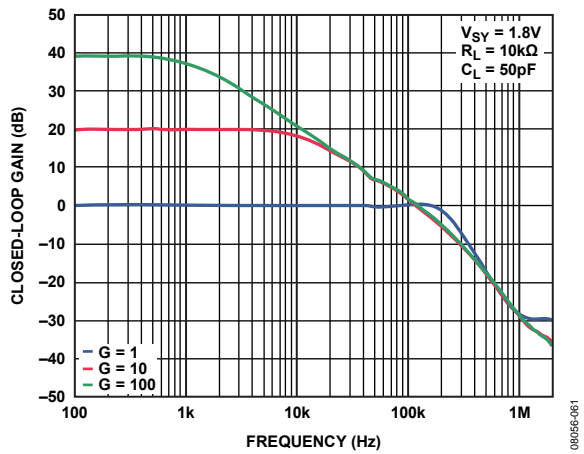

Figure 25. Closed-Loop Gain vs. Frequency

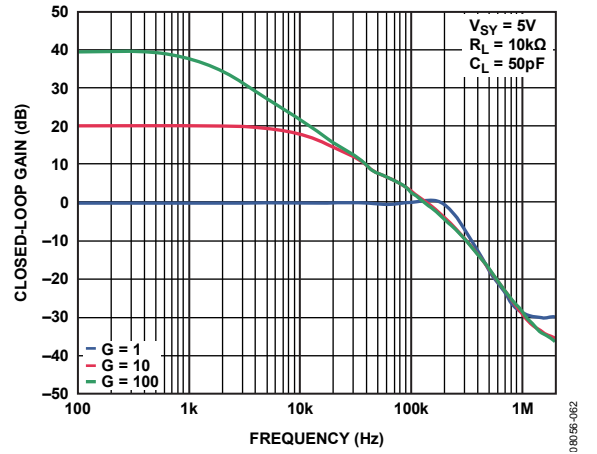

Figure 28. Closed-Loop Gain vs. Frequency

# ADA4051-1/ADA4051-2

$T_A = 25^\circ\text{C}$ , unless otherwise noted.

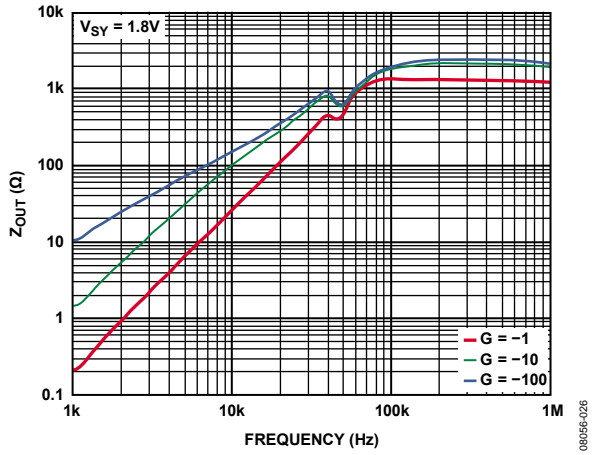

Figure 29. Output Impedance vs. Frequency

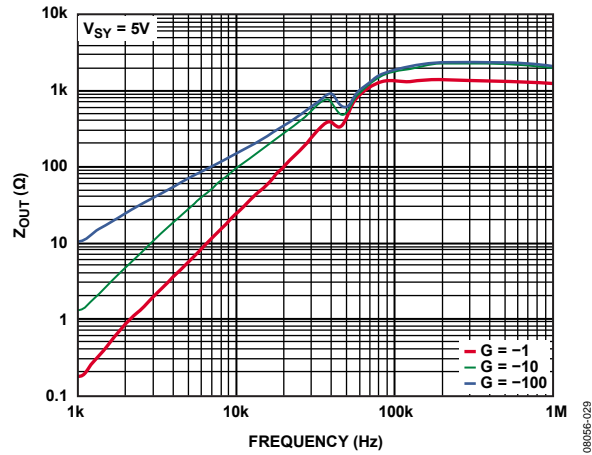

Figure 32. Output Impedance vs. Frequency

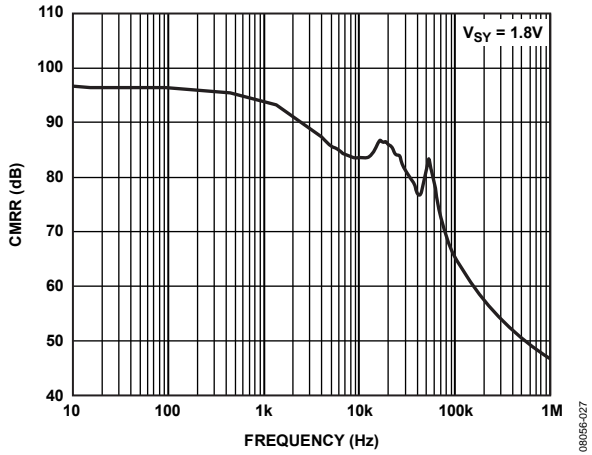

Figure 30. CMRR vs. Frequency

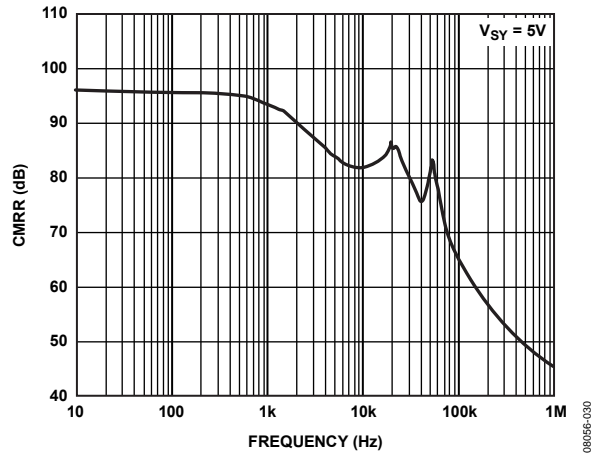

Figure 33. CMRR vs. Frequency

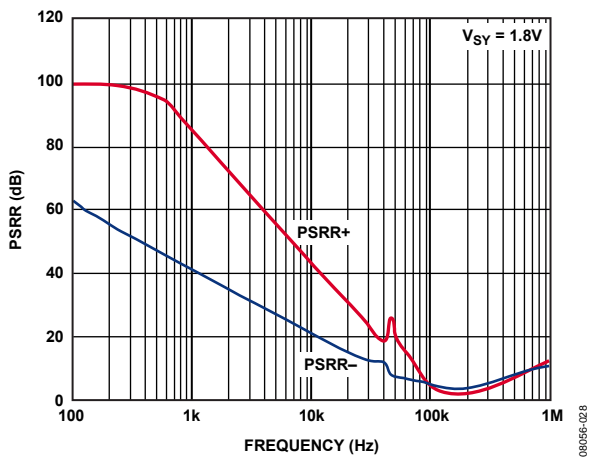

Figure 31. PSRR vs. Frequency

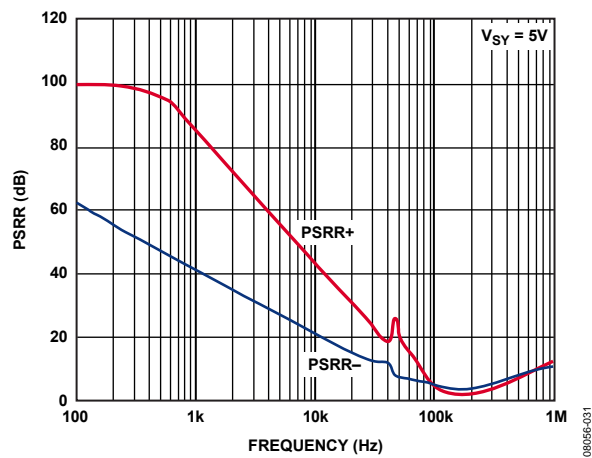

Figure 34. PSRR vs. Frequency

T<sub>A</sub> = 25°C, unless otherwise noted.

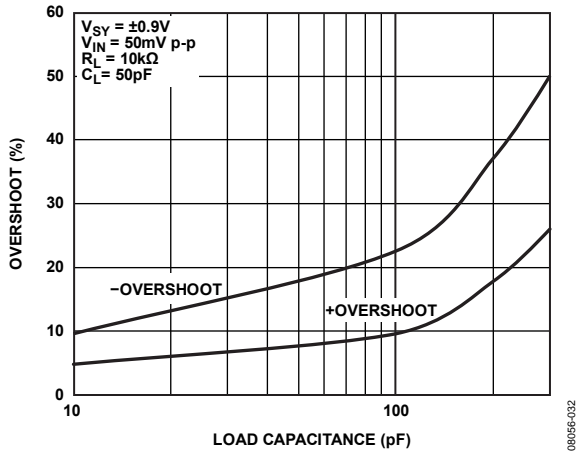

Figure 35. Small-Signal Overshoot vs. Load Capacitance

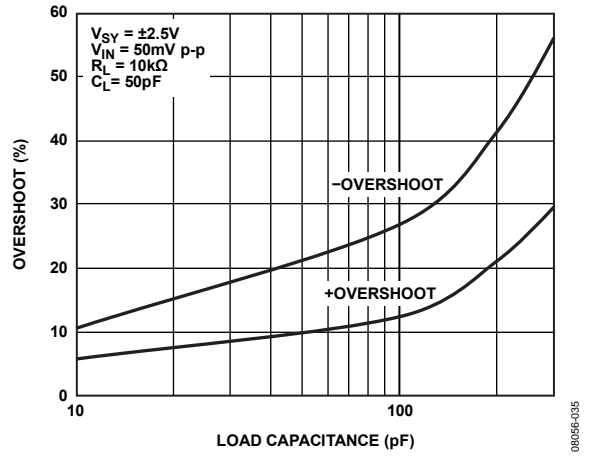

Figure 38. Small-Signal Overshoot vs. Load Capacitance

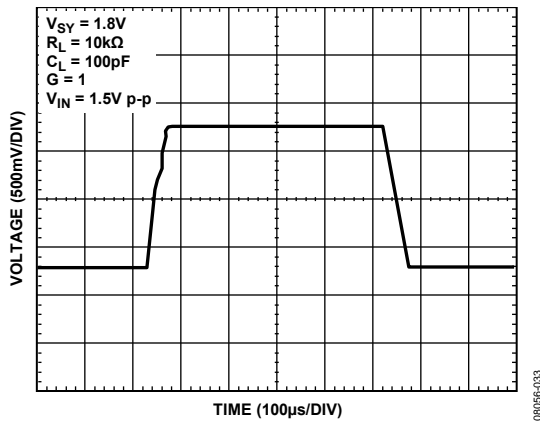

Figure 36. Large-Signal Transient Response

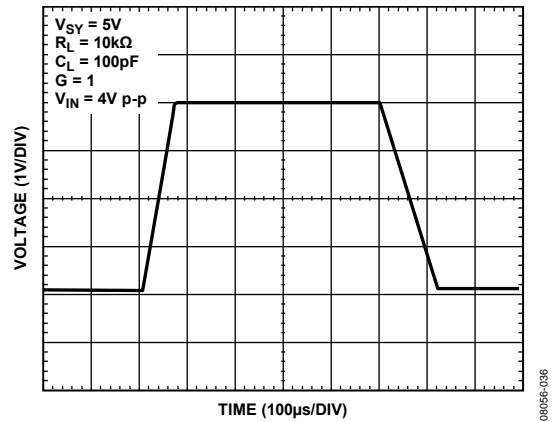

Figure 39. Large-Signal Transient Response

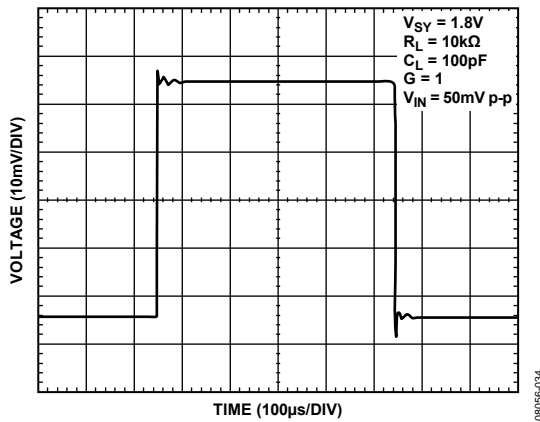

Figure 37. Small-Signal Transient Response

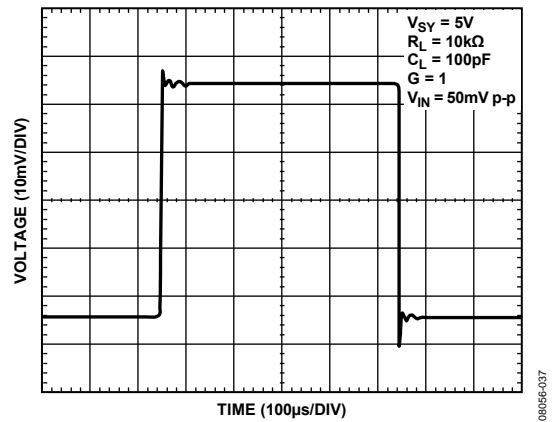

Figure 40. Small-Signal Transient Response

# ADA4051-1/ADA4051-2

$T_A = 25^\circ\text{C}$ , unless otherwise noted.

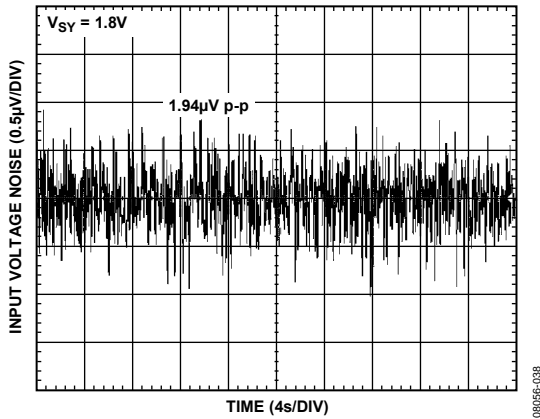

Figure 41. Input Voltage Noise, 0.1 Hz to 10 Hz

08056-038

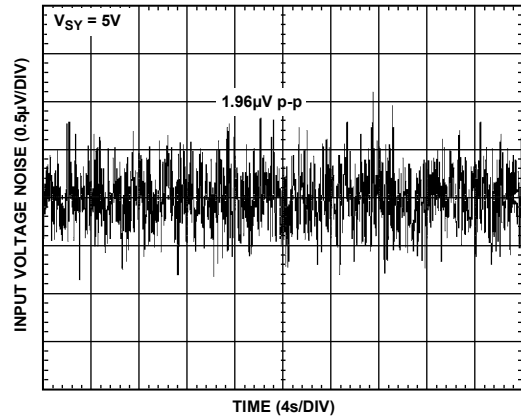

Figure 44. Input Voltage Noise, 0.1 Hz to 10 Hz

08056-041

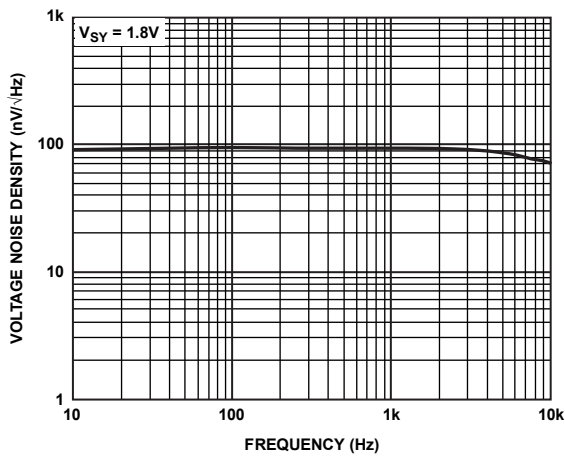

Figure 42. Voltage Noise Density vs. Frequency

08056-039

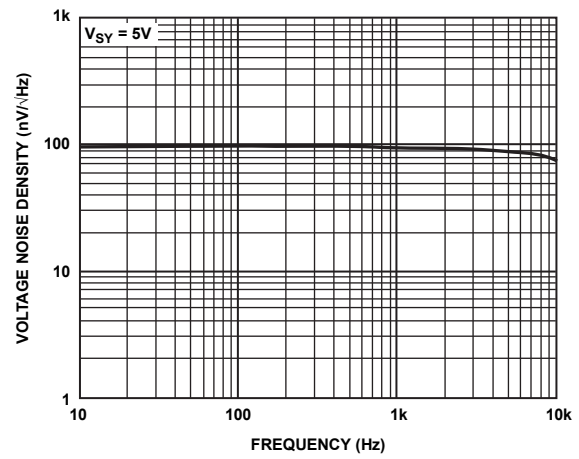

Figure 45. Voltage Noise Density vs. Frequency

08056-042

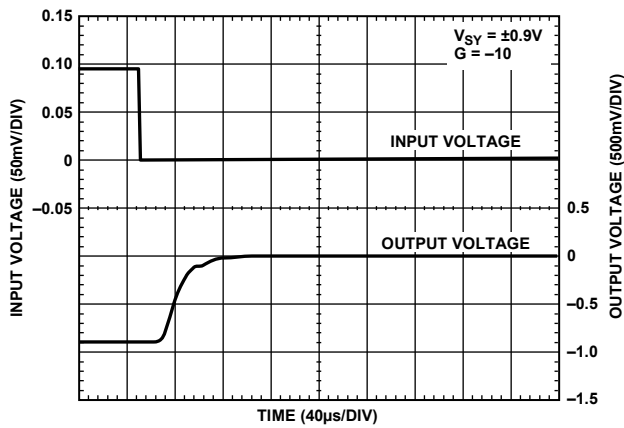

Figure 43. Positive Overload Recovery

08056-040

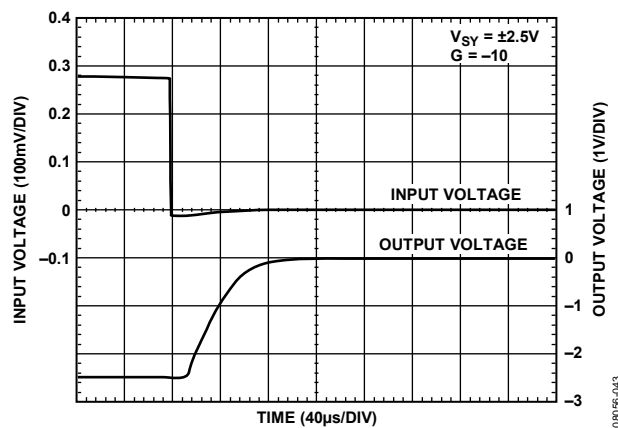

Figure 46. Positive Overload Recovery

08056-043

$T_A = 25^\circ\text{C}$ , unless otherwise noted.

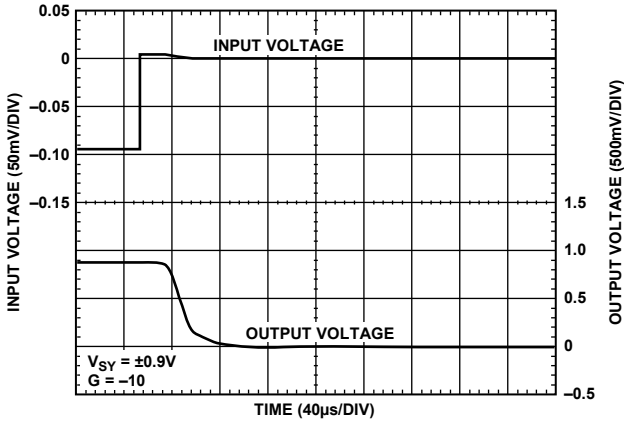

Figure 47. Negative Overload Recovery

08056-044

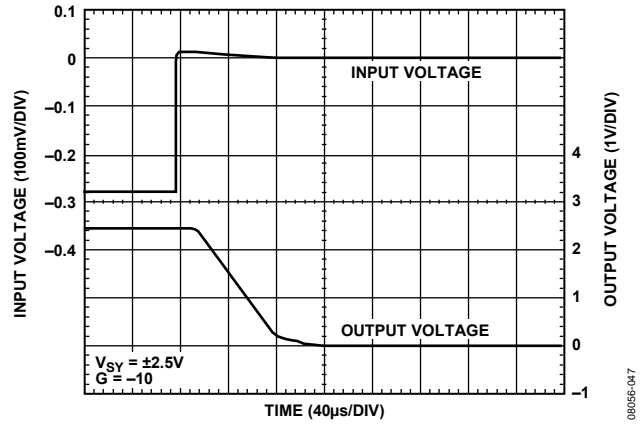

Figure 50. Negative Overload Recovery

08056-047

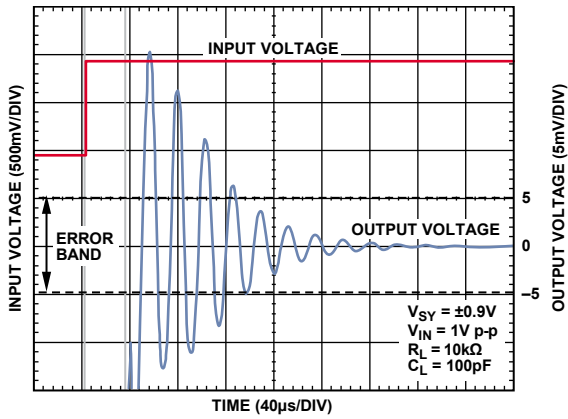

Figure 48. Positive Settling Time to 0.1%

08056-045

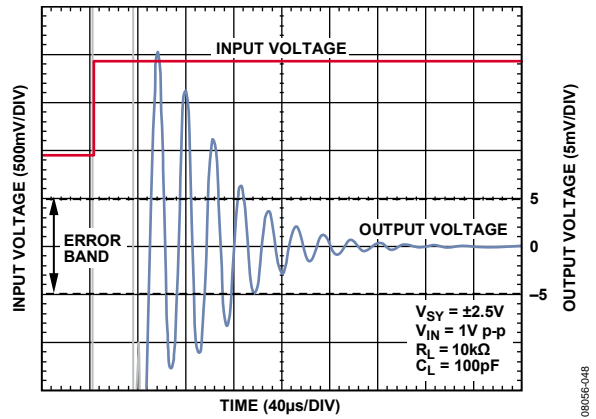

Figure 51. Positive Settling Time to 0.1%

08056-048

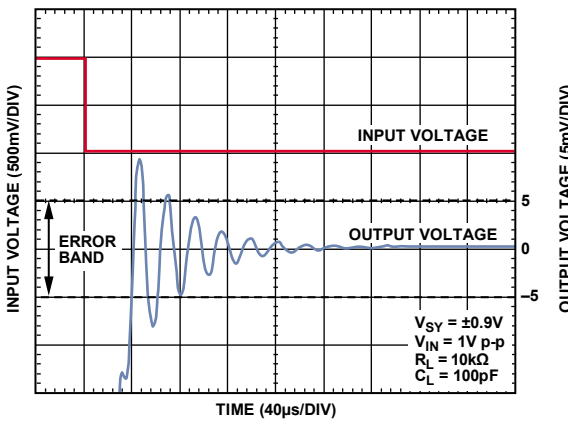

Figure 49. Negative Settling Time to 0.1%

08056-046

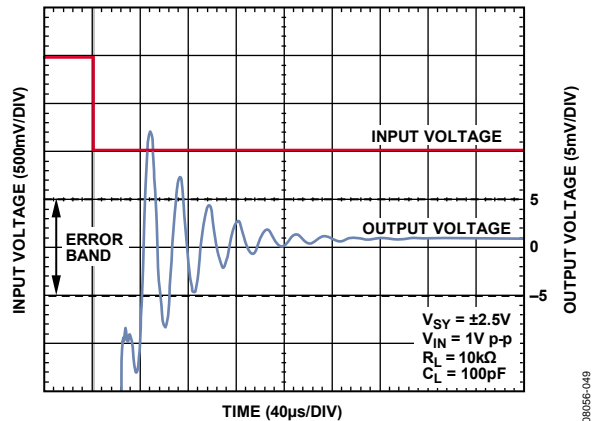

Figure 52. Negative Settling Time to 0.1%

08056-049

# ADA4051-1/ADA4051-2

T<sub>A</sub> = 25°C, unless otherwise noted.

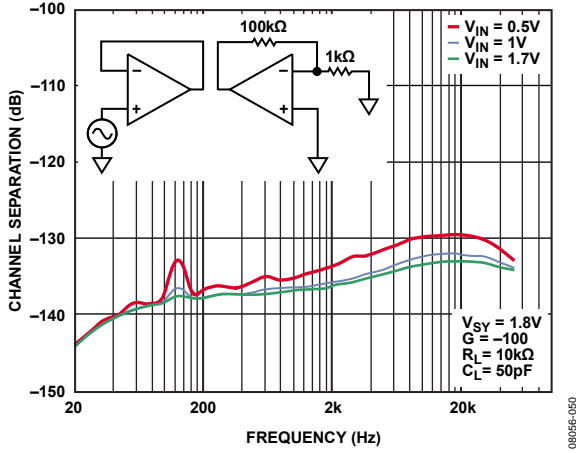

Figure 53. Channel Separation vs. Frequency

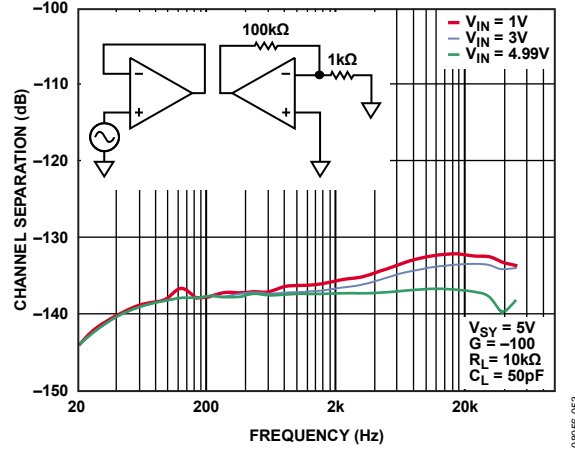

Figure 56. Channel Separation vs. Frequency

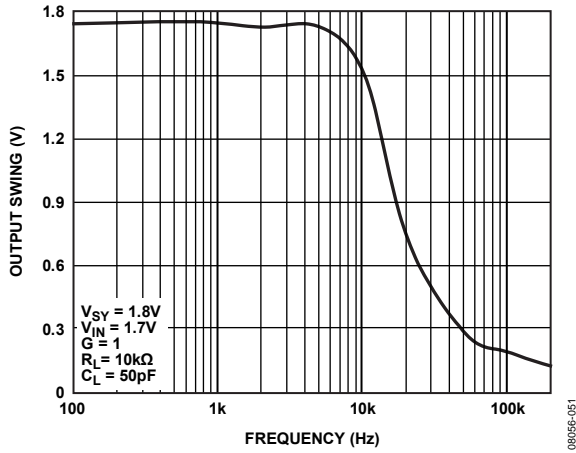

Figure 54. Output Swing vs. Frequency

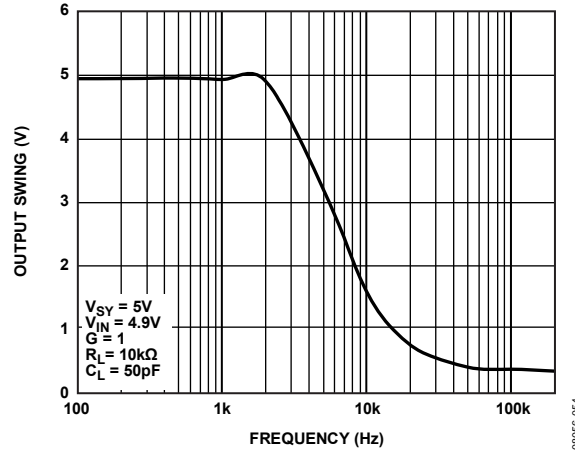

Figure 57. Output Swing vs. Frequency

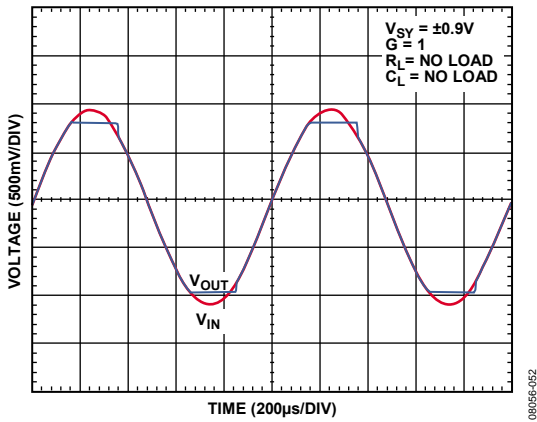

Figure 55. No Phase Reversal

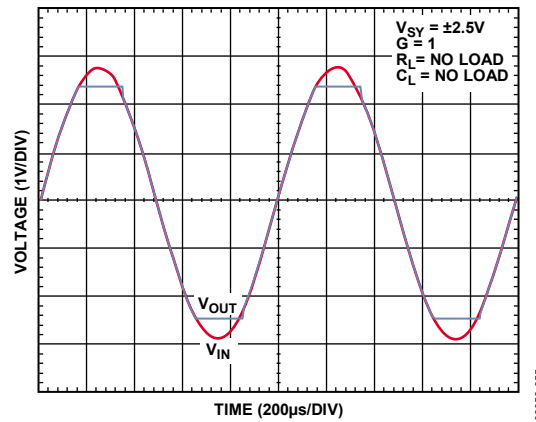

Figure 58. No Phase Reversal

## THEORY OF OPERATION

The ADA4051-1/ADA4051-2 micropower chopper operational amplifiers feature a novel, patent-pending technique that suppresses offset-related ripple in a chopper amplifier. Instead of filtering the ripple in the ac domain, this technique nulls the amplifier's initial offset in the dc domain, thus preventing ripple at the overall output.

Auto-zeroing and chopping are two techniques widely used in high precision CMOS amplifiers to achieve low offset, low offset drift, and no 1/f noise. Each of these techniques has pros and cons. Auto-zeroing results in more in-band noise due to aliasing introduced by sampling. On the other hand, chopping produces offset-related ripple because it modulates the initial offset associated with the amplifier up to its chopping frequency.

To accomplish the best noise vs. power trade-off, the chopping technique is the better approach when designing a low offset amplifier because there is no increased in-band noise. It is preferable to suppress the offset-related ripple inside a chopper amplifier because the offset-related ripple would otherwise need to be eliminated by an extra off-chip postfilter.

Figure 59 shows the block diagram design of the ADA4051-1/ADA4051-2 chopper amplifiers employing a local feedback loop called autocorrection feedback (ACFB). The main signal path contains an input chopping switch network (CHOP1), a first transconductance amplifier (Gm1), an output chopping switch network (CHOP2), a second transconductance amplifier (Gm2), and a third transconductance amplifier (Gm3). CHOP1 and CHOP2 operate at 40 kHz of chopping frequency to modulate the initial offset and 1/f noise from Gm1 up to the chopping frequency. A fourth transconductance amplifier (Gm4) in the ACFB senses the modulated ripple at the output of CHOP2, caused by the initial offset voltage of Gm1. Then, the ripple is demodulated down to a dc domain through a third chopping switch network (CHOP3), operating with the same chopping clock as CHOP1 and CHOP2. Finally, a null transconductance amplifier (Gm5) tries to null any dc component at the output of Gm1 that would otherwise appear in the overall output as ripple.

A switched-capacitor notch filter (NF) functions to selectively suppress the undesired offset-related ripple without disturbing the desired input signal from the overall input. The desired input dc signal appears as a dc signal at the output of CHOP2. Then, the initial offset is modulated up to the chopping frequency by CHOP3 and filtered out by the NF. Therefore, initial offset does not create any feedback and does not disturb the desired input signal. The NF is synchronized with the chopping clock to filter out the modulated component. In the same manner, the offset of Gm5 is filtered out by the combination of CHOP3 and the NF, enabling accurate ripple sensing at the output of CHOP2.

In parallel with the high dc gain path, a feedforward transconductance amplifier (Gm6) is added to bypass the phase shift introduced by the ACFB at the chopping frequency. Gm6 is designed to have the same transconductance as Gm1 to avoid

pole-zero doublets. This design prevents any instability introduced by the ACFB in the overall feedback loop.

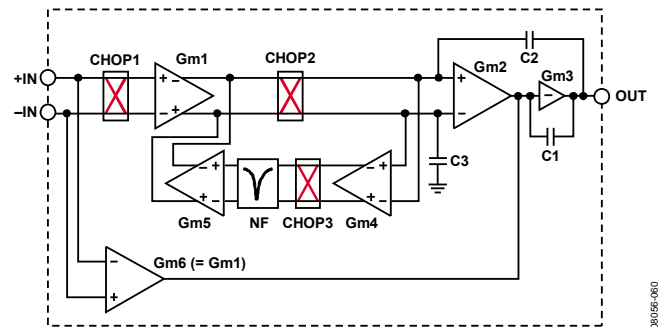

Figure 59. ADA4051-1/ADA4051-2 Chopper Amplifiers Block Diagram

The voltage noise density, which is equal to the thermal noise floor dominated by the Gm1, is essentially flat from dc to the chopping frequency because CHOP1 and CHOP2 eliminate the 1/f noise generated in Gm1 and the ACFB does not contribute any additional noise. Although the ACFB suppresses the ripple related to the chopping, there is a remaining voltage ripple. To further suppress the remaining ripple down to a desired level, it is recommended to have a postfilter at the output of the amplifier.

The remaining voltage ripple originates from two sources. The first type of ripple is due to the residual ripple associated with the initial offset of the Gm1. It is proportional to the magnitude of the initial offset and creates a spectrum at the chopping frequency ( $f_{CHOP}$ ). When the amplifier is configured as a unity-gain buffer, this ripple has a typical value of 4.9  $\mu\text{V rms}$  and a maximum of 34.7  $\mu\text{V rms}$ . The second type of ripple is due to the intermodulation between the high frequency input signal and the chopping frequency. This ripple depends on the input frequency ( $f_{IN}$ ) and creates a spectrum at frequencies equal to the difference between the chopping frequency and the input frequency ( $f_{CHOP} - f_{IN}$ ), as well as at frequencies equal to the summation of the chopping frequency and the input frequency ( $f_{CHOP} + f_{IN}$ ). The magnitude of the ripple for different input frequencies is shown in Figure 60.

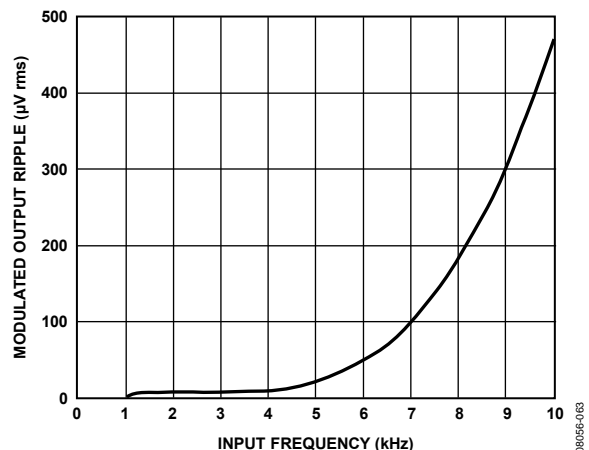

Figure 60. ADA4051-1/ADA4051-2 Modulated Output Ripple vs. Input Frequency

## ADA4051-1/ADA4051-2

The design architecture of the ADA4051-1/ADA4051-2 specifically targets precision signal conditioning applications requiring accurate and stable performance from dc to 10 Hz bandwidth. In summary, the main features of the ADA4051-1/ADA4051-2 chopper amplifiers are

- Considerable suppression of the offset-related ripple
- No affect on the desired input signal as long as its frequency is much lower than the chopping frequency shown in Figure 60
- Achievement of low offset similar to a conventional chopper amplifier
- No introduction of excess noise

The ADA4051-1/ADA4051-2 chopper amplifiers provide a rail-to-rail input range with a 1.8 V to 5.5 V supply voltage range and 20  $\mu$ A supply current consumption over the  $-40^{\circ}\text{C}$  to  $+125^{\circ}\text{C}$  extended industrial temperature range. The gain bandwidth is 125 kHz as a unity-gain stable amplifier up to 100 pF load capacitance.

### INPUT VOLTAGE RANGE

The ADA4051-1/ADA4051-2 have internal ESD protection diodes. These diodes are connected between the inputs and each supply rail to protect the input MOSFETs from an electrical discharge event and are reversed-biased during normal operation. This protection scheme allows voltages as high as approximately 0.3 V beyond the supplies ( $\pm V_{SY} \pm 0.3$  V) to be applied at the input of either terminal without causing permanent damage.

If either input exceeds one of the supply rails by more than 0.3 V, these ESD diodes become forward-biased and large amounts of current begin to flow through them. Without current limiting, this excessive current would cause permanent damage to the device. If the inputs are expected to be subject to overvoltage conditions, install a resistor in series with each input to limit the input current to 10 mA maximum.

The ADA4051-1/ADA4051-2 also have internal circuitry that protects the input stage from high differential voltages. This circuitry is composed of internal 1.33 k $\Omega$  resistors in series with each input and back-to-back diode-connected N-MOSFET (with a typical  $V_T$  of 0.7 V for a  $V_{CM}$  of 0 V) after these series resistors. With normal negative feedback operating conditions, the ADA4051-1/ADA4051-2 amplifiers correct their output to ensure that the two inputs are at the same voltage. However, if the device is configured as a comparator or there are unusual operating conditions, the input voltages can be forced to different potentials, which may cause excessive current to flow through the internal diode-connected N-MOSFETs.

Although the ADA4051-1/ADA4051-2 are rail-to-rail input amplifiers, take care to ensure that the potential difference between the inputs does not exceed  $\pm V_{SY}$  to avert permanent damage to the device.

### OUTPUT PHASE REVERSAL

Although output phase reversal can occur with other amplifiers when the input common-mode voltage range is exceeded, the ADA4051-1/ADA4051-2 amplifiers are designed to prevent any output phase reversal, provided both inputs are maintained approximately within 0.3 V above and below the supply voltages ( $\pm V_{SY} \pm 0.3$  V).

With other amplifiers, the outputs may jump in the opposite direction to the supply rail when a common-mode voltage moves outside the common-mode range. This usually occurs when one of the internal stages of the amplifier no longer has sufficient bias voltage across it and subsequently turns off.

However, with the ADA4051-1/ADA4051-2 amplifiers, if one or both inputs exceed the input voltage range but remain within the  $\pm V_{SY} \pm 0.3$  V range, an internal loop opens and the output remains in saturation mode, without phase reversal, until the input voltage is brought back to within the input voltage range limits as shown in Figure 55 and Figure 58.



# OUTLINE DIMENSIONS

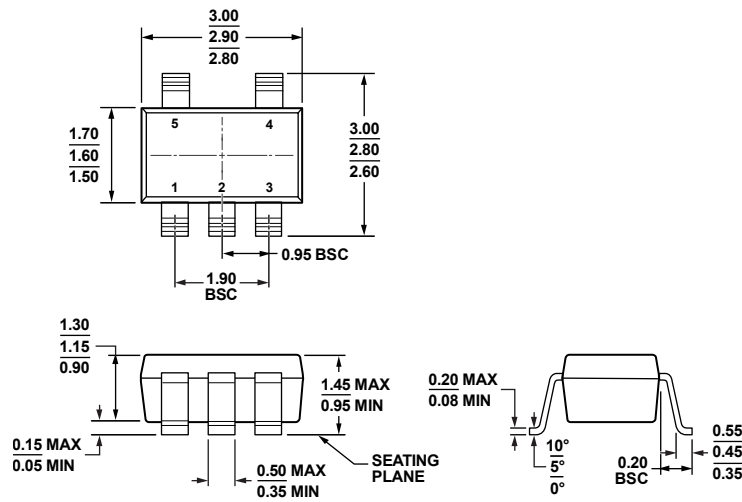

COMPLIANT TO JEDEC STANDARDS MO-178-AA  
 Figure 61. 5-Lead Small Outline Transistor Package [SOT-23]  
 (RJ-5)  
 Dimensions shown in millimeters

121608-A

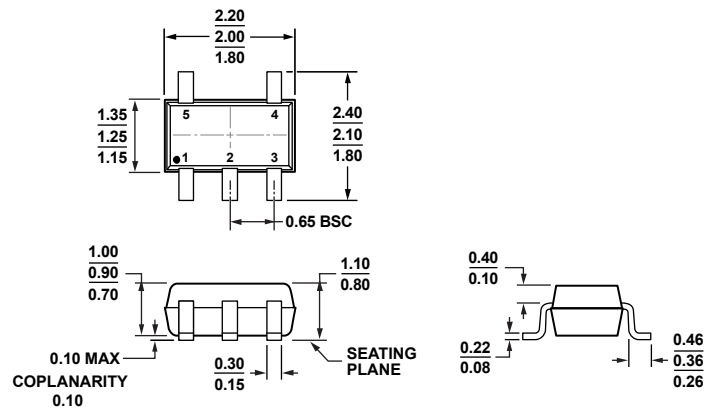

COMPLIANT TO JEDEC STANDARDS MO-203-AA  
 Figure 62. 5-Lead Thin Shrink Small Outline Transistor Package [SC-70]  
 (KS-5)  
 Dimensions shown in millimeters

072809-A

# ADA4051-1/ADA4051-2

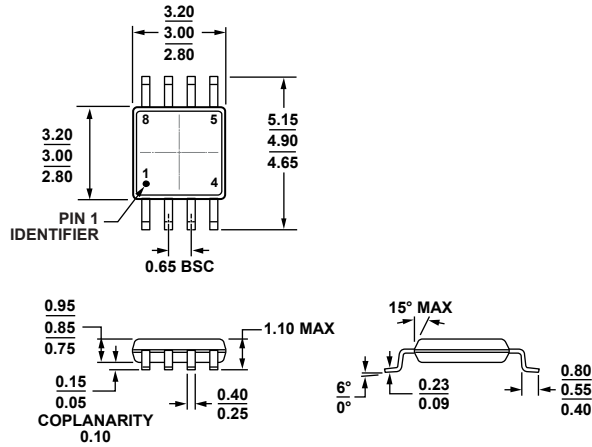

COMPLIANT TO JEDEC STANDARDS MO-187-AA

Figure 63. 8-Lead Mini Small Outline Package [MSOP] (RM-8)

Dimensions shown in millimeters

100709-B

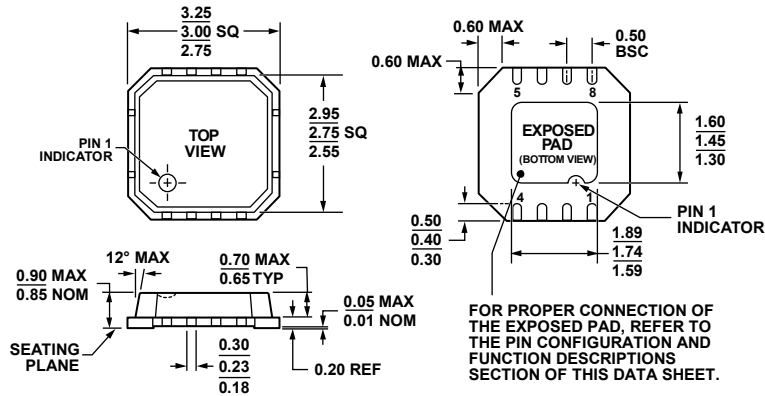

Figure 64. 8-Lead Lead Frame Chip Scale Package [LFCSP\_VD]

3 mm x 3 mm Body, Very Thin, Dual Lead

(CP-8-2)

Dimensions shown in millimeters

090308-B

## ORDERING GUIDE

| Model <sup>1</sup> | Temperature Range | Package Description | Package Option | Branding |
|--------------------|-------------------|---------------------|----------------|----------|
| ADA4051-1ARJZ-R2   | -40°C to +125°C   | 5-Lead SOT-23       | RJ-5           | A0U      |
| ADA4051-1ARJZ-R7   | -40°C to +125°C   | 5-Lead SOT-23       | RJ-5           | A0U      |
| ADA4051-1ARJZ-RL   | -40°C to +125°C   | 5-Lead SOT-23       | RJ-5           | A0U      |
| ADA4051-1AKSZ-R2   | -40°C to +125°C   | 5-Lead SC-70        | KS-5           | A0U      |
| ADA4051-1AKSZ-R7   | -40°C to +125°C   | 5-Lead SC-70        | KS-5           | A0U      |
| ADA4051-1AKSZ-RL   | -40°C to +125°C   | 5-Lead SC-70        | KS-5           | A0U      |
| ADA4051-2ACPZ-R2   | -40°C to +125°C   | 8-Lead LFCSP_VD     | CP-8-2         | A2M      |
| ADA4051-2ACPZ-R7   | -40°C to +125°C   | 8-Lead LFCSP_VD     | CP-8-2         | A2M      |
| ADA4051-2ACPZ-RL   | -40°C to +125°C   | 8-Lead LFCSP_VD     | CP-8-2         | A2M      |
| ADA4051-2ARMZ      | -40°C to +125°C   | 8-Lead MSOP         | RM-8           | A2M      |
| ADA4051-2ARMZ-R7   | -40°C to +125°C   | 8-Lead MSOP         | RM-8           | A2M      |
| ADA4051-2ARMZ-RL   | -40°C to +125°C   | 8-Lead MSOP         | RM-8           | A2M      |

<sup>1</sup> Z = RoHS Compliant Part.

**NOTES**

**NOTES**

## Данный компонент на территории Российской Федерации

### Вы можете приобрести в компании MosChip.

Для оперативного оформления запроса Вам необходимо перейти по данной ссылке:

<http://moschip.ru/get-element>

Вы можете разместить у нас заказ для любого Вашего проекта, будь то серийное производство или разработка единичного прибора.

В нашем ассортименте представлены ведущие мировые производители активных и пассивных электронных компонентов.

Нашей специализацией является поставка электронной компонентной базы двойного назначения, продукции таких производителей как XILINX, Intel (ex.ALTERA), Vicor, Microchip, Texas Instruments, Analog Devices, Mini-Circuits, Amphenol, Glenair.

Сотрудничество с глобальными дистрибьюторами электронных компонентов, предоставляет возможность заказывать и получать с международных складов практически любой перечень компонентов в оптимальные для Вас сроки.

На всех этапах разработки и производства наши партнеры могут получить квалифицированную поддержку опытных инженеров.

Система менеджмента качества компании отвечает требованиям в соответствии с ГОСТ Р ИСО 9001, ГОСТ РВ 0015-002 и ЭС РД 009

### Офис по работе с юридическими лицами:

105318, г.Москва, ул.Щербаковская д.3, офис 1107, 1118, ДЦ «Щербаковский»

Телефон: +7 495 668-12-70 (многоканальный)

Факс: +7 495 668-12-70 (доб.304)

E-mail: [info@moschip.ru](mailto:info@moschip.ru)

Skype отдела продаж:

moschip.ru

moschip.ru\_4

moschip.ru\_6

moschip.ru\_9