

**Load current 10 to 25 A
Small Tab Terminal SSR**

AQ-J RELAYS

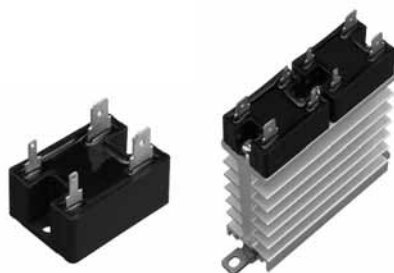

Slim heat sink combined type

RoHS compliant

FEATURES

- 1. Compact Size**
W 28 × L 38 × H 30 mm
W 1.102 × L 1.496 × H 1.181 inch
- 2. Built-in varistor**
- 3. Reverse input connection prevention function**
- 4. Labor Saving (tab terminal)**
- 5. Heat sink combined types ready to mount on DIN rail added (Radiating grease and screws assembly process not needed)**
- 6. Output arrangement 1 Form A and 1 Form A × 2 available in the heat sink combined type**

Note: * International standards are acquired for AQ-J SSR stand-alone, not applied to heat sink combined type.

TYPICAL APPLICATIONS

- 1. Kitchen appliances**
- 2. Vending machine**
- 3. Injection molding machine**
- 4. Packing machine**
- 5. Amusement machine**

ORDERING INFORMATION

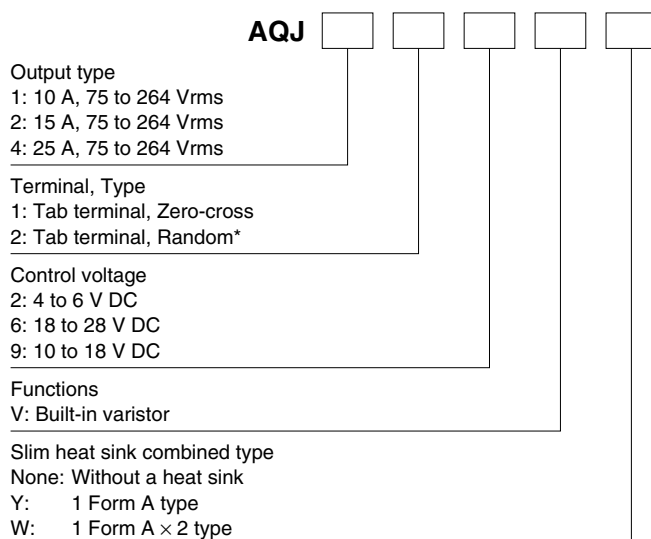

Note: * Random type is available by custom order.

TYPES

1. AQ-J Solid State Relays

Type	Load current	Load voltage	Control voltage	Part No.
Zero-cross*	10 A	75 to 264 Vrms	4 to 6V DC	AQJ112V
			10 to 18V DC	AQJ119V
			18 to 28V DC	AQJ116V
	15 A		4 to 6V DC	AQJ212V
			10 to 18V DC	AQJ219V
			18 to 28V DC	AQJ216V
	25 A		4 to 6V DC	AQJ412V
			10 to 18V DC	AQJ419V
			18 to 28V DC	AQJ416V

Standard Packing: carton: 10 pcs., case: 200 pcs.

Note: Random type also available. Please contact our sales office.

2. AQ-J Slim Heat Sink Combined Type

Output configuration	Type	Load current	Load voltage	Control voltage	Part No.	
1 Form A	Zero-cross*	10 A	75 to 264 Vrms	4 to 6 V DC	AQJ112VY	
				10 to 18 V DC	AQJ119VY	
				18 to 28 V DC	AQJ116VY	
		20 A		4 to 6 V DC	AQJ412VY	
				10 to 18 V DC	AQJ419VY	
				18 to 28 V DC	AQJ416VY	
1 Form A × 2		10 A (per 1 Form A)			4 to 6 V DC	AQJ112VW
					10 to 18 V DC	AQJ119VW
					18 to 28 V DC	AQJ116VW
		15 A (per 1 Form A)			4 to 6 V DC	AQJ412VW
					10 to 18 V DC	AQJ419VW
					18 to 28 V DC	AQJ416VW

Standard Packing; no carton, case: 10 pcs.
 Note: * Random type also available. Please contact our sales office.

3. Accessories

Type	Part No.	Packaged quantity
Slim heat sink (28 mm wide) (Mountable on a DIN rail)	AQP-HS-SJ10A	No carton, 10 in a case
Slim heat sink (45 mm wide) (Mountable on a DIN rail)	AQP-HS-SJ20A	No carton, 8 in a case
Standard heat sink (10 A and 15 A)	AQP-HS-J10A	5 in a carton, 20 in a case
Standard heat sink (25 A only)	AQP-HS-J25A	No carton, 5 in a case
DIN rail mounting plate	AQP-DPJ	No carton, 50 in a case
Mounting rail	AT8-DLA1	1 in a carton, 100 in a case
Fastening plate	AT8-DLE	1 in a carton, 200 in a case

RATING

1. Ratings (Test sample: AQ-J stand-alone, Measurement condition: at 20°C 68°F, input ripple: 1% or less)

Item	Part No.	AQJ112V AQJ212V AQJ412V	AQJ119V AQJ219V AQJ419V	AQJ116V AQJ216V AQJ416V	Remarks
Input side	Rated voltage	5 V DC	12 V DC	24 V DC	*1
	Control voltage	4 to 6 V DC	10 to 18 V DC	18 to 28 V DC	
	Input impedance	Approx. 0.26 kΩ	Approx. 0.8 kΩ	Approx. 1.6 kΩ	
	Drop-out voltage	Min. 1 V DC			
Output side	Max. load current	10 A*2	15 A*2	25 A*2	In one cycle at 60 Hz
	Load voltage	75 to 264 Vrms			
	Frequency	45 to 65 Hz			
	Non-repetitive surge current	100 A*3	150 A*3	250 A*3	
	"OFF-state" leakage current	Max. 5 mA			
	"ON-state" voltage drop	Max. 1.6 V			
	Min. load current*4	50 mA			

Notes: *1. Refer to REFERENCE DATA "3. Input current vs. input voltage characteristics".
 *2. Refer to REFERENCE DATA "1. Load current vs. ambient temperature".
 *3. Refer to REFERENCE DATA "2. Non-repetitive surge current vs. carrying time".
 *4. When the load current is less than the rated minimum load current, please refer to "Cautions for Use of Solid State Relays".

2. Ratings (AQ-J slim heat sink combined type, Measurement condition: at 20°C 68°F, input ripple: 1 % or less)

Item	Part No.	AQJ112V(Y-W) AQJ412V(Y-W)	AQJ119V(Y-W) AQJ419V(Y-W)	AQJ116V(Y-W) AQJ416V(Y-W)	AQJ412VW AQJ419VW AQJ416VW	Remarks
Input side	Rated voltage	5 V DC	12 V DC	24 V DC	*1	
	Control voltage	4 to 6 V DC	10 to 18 V DC	18 to 28 V DC		
	Input impedance	Approx. 0.26 kΩ	Approx. 0.8 kΩ	Approx. 1.6 kΩ		
	Drop-out voltage	Min. 1 V DC				
Output side	Output arrangement	1 Form A		1 Form A × 2		
	Max. load current	10 A*2	20 A*2	10 A*2	15 A*2	
	Load voltage	75 to 264 Vrms				
	Frequency	45 to 65 Hz				
	Non-repetitive surge current	100 A*3	250 A*3	100 A*3	250 A*3	
	"OFF-state" leakage current	Max. 5 mA				
	"ON-state" voltage drop	Max. 1.6 V				
Min. load current*4	50 mA					

Notes: *1. Refer to REFERENCE DATA "3. Input current vs. input voltage characteristics".
 *2. Refer to REFERENCE DATA "1. Load current vs. ambient temperature".
 *3. Refer to REFERENCE DATA "2. Non-repetitive surge current vs. carrying time".
 *4. When the load current is less than the rated minimum load current, please refer to "Cautions for Use of Solid State Relays".

3. Characteristics (Measurement condition: at 20°C 68°F, input ripple: 1% or less)

Item	Characteristics	Remarks
Operate time	Max. 1/2 cycle of voltage sine wave + 1 ms	
Release time	Max. 1/2 cycle of voltage sine wave + 1 ms	
Insulation resistance	Min. 100 MΩ between input, output and case	at 500 V DC
Breakdown voltage	3,000 Vrms between input and output 2,500 Vrms between input, output and case	for 1 minute
Vibration resistance	SSR stand-alone: 10 to 55 Hz, double amplitude of 1.5 mm Slim heat sink combined type: 10 to 55 Hz, double amplitude of 0.75 mm	X, Y, Z axes
Shock resistance	SSR stand-alone: Min. 980 m/s ² Slim heat sink combined type: Min. 197 m/s ²	X, Y, Z axes
Ambient temperature	-30 to +80°C -22 to +176°F	Non-condensing at low temperatures
Storage temperature	-30 to +100°C -22 to +212°F	Non-condensing at low temperatures
Operational method	Zero-cross (Turn ON and Turn OFF)	

REFERENCE DATA

(1) AQ-J Solid State Relays

1. Load current vs. ambient temperature

Tested condition:

- If attached to a heat sink, use a heat conductive compound (Ex. Momentive Performance Materials Inc. YG6111 or TSK5303) of similar coating to improve cooling
- Without external heat sink
If the mounting surface is not metallic and a heat sink is not used, expose the bottom surface and plate surface to improve heat dissipation.

3) The current value is per 1a.

(A) slim heat sink	AQP-HS-SJ20A
(B) slim heat sink	AQP-HS-SJ10A
(C) standard heat sink	AQP-HS-J10A
(D) DIN rail mounting plate	AQP-DPJ
(E) standard heat sink	AQP-HS-J25A

Use load current within range specified in the figure below

(1) 10 A type (when using heat sink or iron plate)

(2)-1. 15 A type (when using iron plate)



(2)-2. 15 A type (when using a heat sink)

(3)-1. 25 A type (when using iron plate)

(3)-2. 25 A type (when using a heat sink)



2. Non-repetitive surge current vs. carrying time*

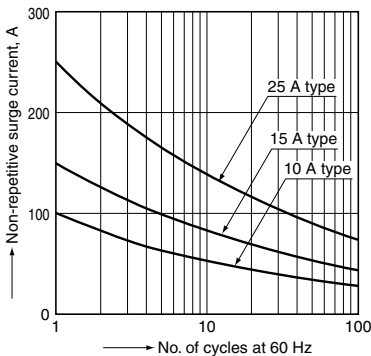

3. Input current vs. input voltage characteristics

(10 A, 15 A and 25 A common)

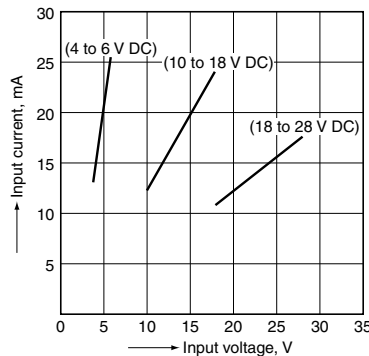

Note: * The above chart shows non-repetitive maximum rating. If a surge current is applied repeatedly, please keep it approximately 50% or less than the values shown in the above graph.

(2) AQ-J Slim Heat Sink Combined Type

1. Load current vs. ambient temperature characteristics

(1) Output arrangement: 1 Form A



Use load current within range specified in the figure below

(2) Output arrangement: 1 Form A × 2



Note:
When two contacts are operated simultaneously.
In the case of a single-contact operation, the rating of
(1) AQJ11*VY, AQJ41*VY applies.

2. Surge current vs. carrying time characteristics*



3. Input current vs. input voltage characteristics



Note: * The above chart shows non-repetitive maximum rating. If a surge current is applied repeatedly, please keep it approximately 50% or less than the values shown in the above graph.

DIMENSIONS (mm inch)

The CAD data of the products with a **CAD** mark can be downloaded from: <https://industrial.panasonic.com/ac/e/>

1. AQ-J Stand Alone

CAD



External dimensions



Mounting dimensions

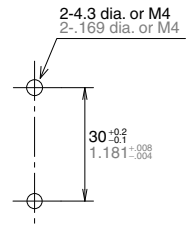

General tolerance: $\pm 1.0 \pm .039$

2.-(1) AQ-J Slim Heat Sink Combined Type Output Arrangement: 1 Form A

CAD



External dimensions

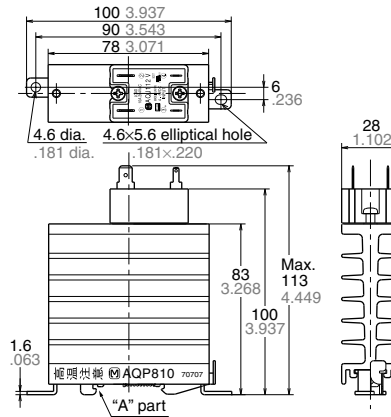

Mounting dimensions (Top view)

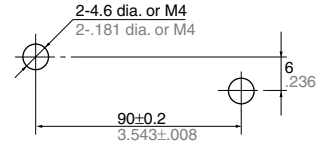

General tolerance: $\pm 1.0 \pm .039$

2.-(2) AQ-J Slim Heat Sink Combined Type Output Arrangement: 1 Form A × 2

CAD



External dimensions

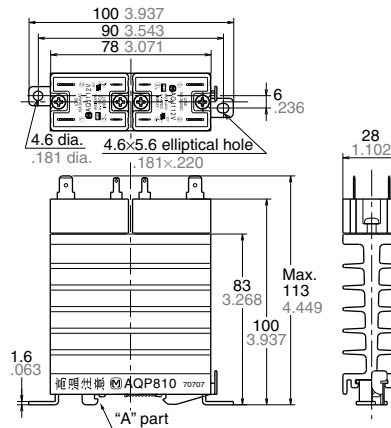

Mounting dimensions (Top view)

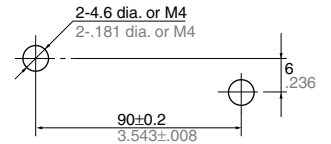

General tolerance: $\pm 1.0 \pm .039$

ACCESSORIES (mm inch)

AQP-HS-SJ10A Slim Heat Sink

CAD



Note: When using on a DIN rail, please install so that the "A" part is on top.

External dimensions



Mounting dimensions (Top view)



General tolerance: $\pm 1.0 \pm .039$

AQP-HS-SJ20A Slim Heat Sink

CAD



Note: When using on a DIN rail, please install so that the "A" part is on top.

External dimensions



Mounting dimensions (Top view)



General tolerance: $\pm 1.0 \pm .039$

AQP-HS-J10A Standard Heat Sink (for 10 A and 15 A types)

CAD



Note: When using on a DIN rail, please install so that the "A" part is on top.

External dimensions

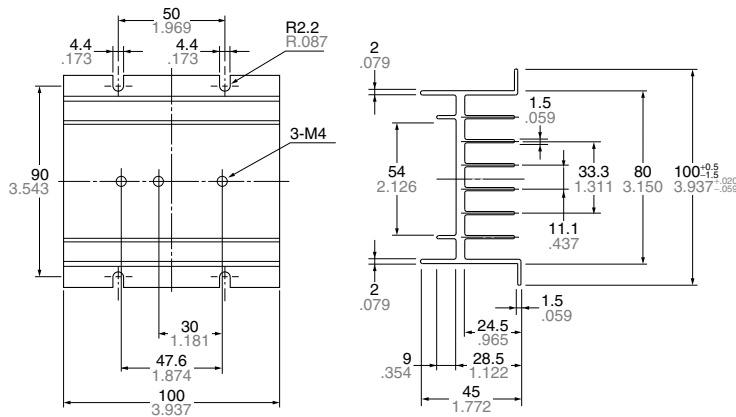

Mounting dimensions

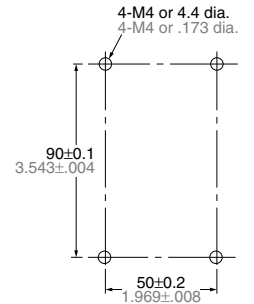

General tolerance: $\pm 1.0 \pm .039$

**AQP-HS-J25A Standard Heat Sink
(for 25 A type)**

CAD



External dimensions



Mounting dimensions

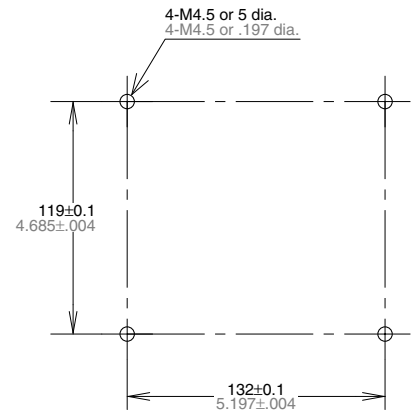

General tolerance: $\pm 1.0 \pm .039$

AQP-DPJ DIN Rail Mounting Plate

CAD



External dimensions



General tolerance: $\pm 1.0 \pm .039$

AT8-DLA1 Mounting rail

CAD



AT8-DLE Fastening plate

CAD

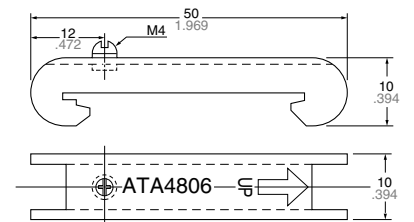

SCHEMATIC AND WIRING DIAGRAMS



NOTES

1. Part number indication

The AQ-J slim heat sink combined type is a product combining the AQ-J SSR and AQ-J SSR heat sinks. The part numbers are indicated on each AQ-J SSR and heat sink.

Ex) In the case of AQJ112VY

Part number of AQ-J SSR: AQJ112V

Part number of the heat sink: AQP810*

When using these parts, please refer to REFERENCE DATA, "1. Load current vs. ambient temperature".

Note: * The Japanese part number is printed on the following accessories in stead of Global part number. Please refer to the below chart for interpretation from Japanese to Global part number.

Products	Japanese Part No.	Global Part No.	Compatible models
Slim heat sink (28 mm)	AQP810	AQP-HS-SJ10A	AQ-J
Slim heat sink (45 mm)	AQP812	AQP-HS-SJ20A	AQ-A, AQ-J
Standard heat sink (10 A and 15 A)	AQP811	AQP-HS-J10A	AQ-A, AQ-J
Standard heat sink (25 A and 40 A)	AQP808	AQP-HS-J25A	AQ-A, AQ-J
Standard heat sink (AQ-A 25 A)	AQP804	AQP-HS-30/40A	AQ-A
DIN Rail Mounting Plate (for AQ-A and AQ-J)	AQP809	AQP-DPJ	AQ-A, AQ-J
Mounting Rail	ATA48011	AT8-DLA1	AQ-A, AQ-J
Terminal Cover (for AQ-A)	AQA801	AQA801	AQ-A

Recommended Temperature Controllers



<KT4H Temperature Controller>

Our temperature controller is recommended for use with our Solid State Relays.

Features

- Space saving requiring only a depth of 65 mm
- Data collection possible through a PLC using RS485 communication
- Tool port is standard for easy data setting
- Inverted LCD + backlight for good legibility with large characters
- Excellent operability and rich optional control functions

Substitute part numbers

Power supply	Control output	Part No.
100 to 240 Vrms	Non-contact voltage output	AKT4H112100

* For detailed product information about temperature controllers, please refer to our website: <https://industrial.panasonic.com/ac/e/>

Please contact

Panasonic Corporation

Electromechanical Control Business Division

■ 1006, Oaza Kadoma, Kadoma-shi, Osaka 571-8506, Japan
industrial.panasonic.com/ac/e/

Panasonic[®]

©Panasonic Corporation 2018

Mouser Electronics

Authorized Distributor

Click to View Pricing, Inventory, Delivery & Lifecycle Information:

Panasonic:

[AQJ212V](#) [AQJ216V](#) [AQJ219V](#) [AQJ412V](#) [AQJ416V](#) [AQJ419V](#) [AQJ112V](#) [AQJ116V](#) [AQJ119V](#) [AQJ422V](#)
[AQJ119VY](#)

Данный компонент на территории Российской Федерации

Вы можете приобрести в компании MosChip.

Для оперативного оформления запроса Вам необходимо перейти по данной ссылке:

<http://moschip.ru/get-element>

Вы можете разместить у нас заказ для любого Вашего проекта, будь то серийное производство или разработка единичного прибора.

В нашем ассортименте представлены ведущие мировые производители активных и пассивных электронных компонентов.

Нашей специализацией является поставка электронной компонентной базы двойного назначения, продукции таких производителей как XILINX, Intel (ex.ALTERA), Vicor, Microchip, Texas Instruments, Analog Devices, Mini-Circuits, Amphenol, Glenair.

Сотрудничество с глобальными дистрибьюторами электронных компонентов, предоставляет возможность заказывать и получать с международных складов практически любой перечень компонентов в оптимальные для Вас сроки.

На всех этапах разработки и производства наши партнеры могут получить квалифицированную поддержку опытных инженеров.

Система менеджмента качества компании отвечает требованиям в соответствии с ГОСТ Р ИСО 9001, ГОСТ РВ 0015-002 и ЭС РД 009

Офис по работе с юридическими лицами:

105318, г.Москва, ул.Щербаковская д.3, офис 1107, 1118, ДЦ «Щербаковский»

Телефон: +7 495 668-12-70 (многоканальный)

Факс: +7 495 668-12-70 (доб.304)

E-mail: info@moschip.ru

Skype отдела продаж:

moschip.ru

moschip.ru_4

moschip.ru_6

moschip.ru_9