



Features

- Long life carbon element
- Assortment of resistance tapers
- 45 mm, 60 mm and 100 mm travel lengths
- Single and dual gang elements
- Long operational life
- Tracking error within ± 2 dB



PTF Series Long Life Slide Potentiometer

Electrical Characteristics

Standard Resistance Range 1K ohms to 1 megohm
Standard Resistance Tolerance	... ± 20 %
End Resistance 1 ohm max.
Insulation Resistance @ 500 VDC 100 megohms min.
Dielectric Withstanding Voltage 1000 VAC
Tracking Error ± 2 dB
Standard Taper Linear, Audio
Power Rating - Linear	
45 mm 0.25 watt
60 & 100 mm 0.5 watt
Power Rating - Audio	
45 mm 0.125 watt
60 & 100 mm 0.25 watt
Slider Noise 60 mV max.

Environmental Characteristics

Operational Life 100,000 cycles
TR Shift ± 15 %
Operating Temperature Range -10 °C to $+55$ °C
Resistance to Solder Heat ± 5 %

Mechanical Characteristics

Mechanical Travel See Product Dimensions
Operating Force 50 gf
Stop Strength 5 kgf min.
Shaft Axial Force 10 kgf min.
Shaft Wobble	.. $2(2 \times L/25)$ mm p-p max.
Soldering Condition	
Manual 300 °C ± 5 °C for 3 sec.
Wave 260 °C ± 5 °C for 5 sec.
Wash Not recommended

Product Dimensions

45 mm Length of Travel Lever End Style "A"

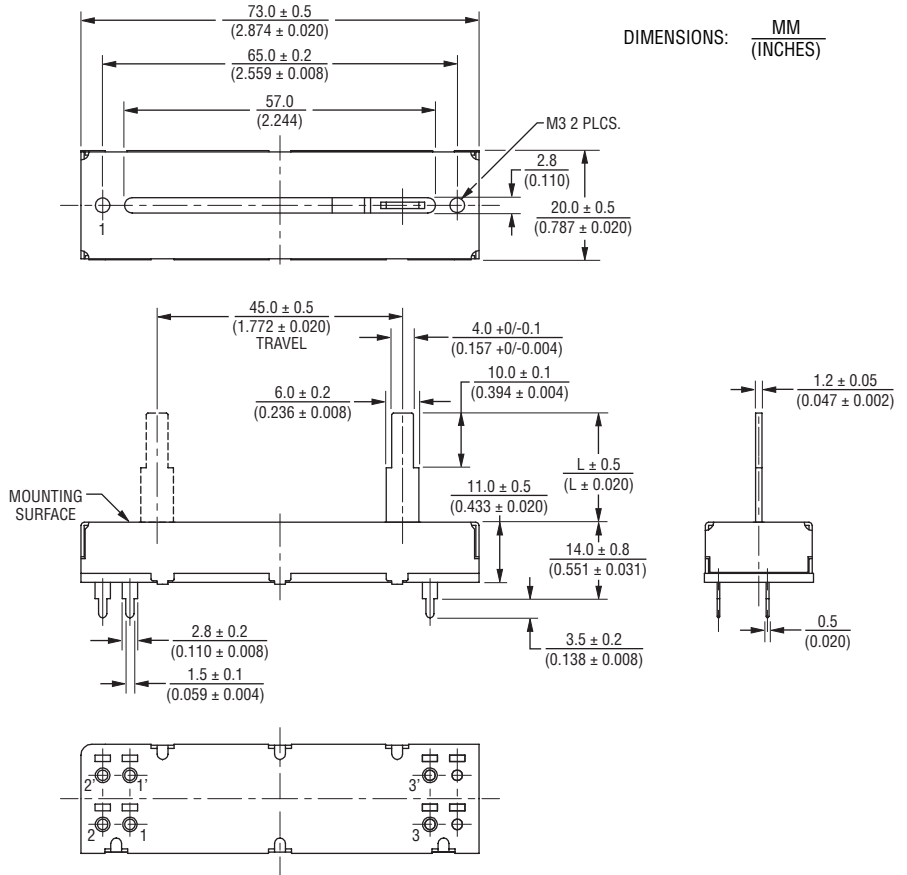

Mounting Hole Detail



Schematics

Single Gang



Dual Gang



*RoHS Directive 2002/95/EC Jan 27, 2003 including Annex
Specifications are subject to change without notice.
Customers should verify actual device performance in their specific applications.

Applications

- Mixing consoles
- Drum machines
- Keyboards and synthesizers
- Equalizers

PTF Series Long Life Slide Potentiometer

BOURNS®

Product Dimensions

60 mm Length of Travel
Lever End Style "A"



Mounting Hole Detail



Specifications are subject to change without notice.
Customers should verify actual device performance in their specific applications.

PTF Series Long Life Slide Potentiometer

BOURNS®

Product Dimensions

100 mm Length of Travel
Lever End Style "A"

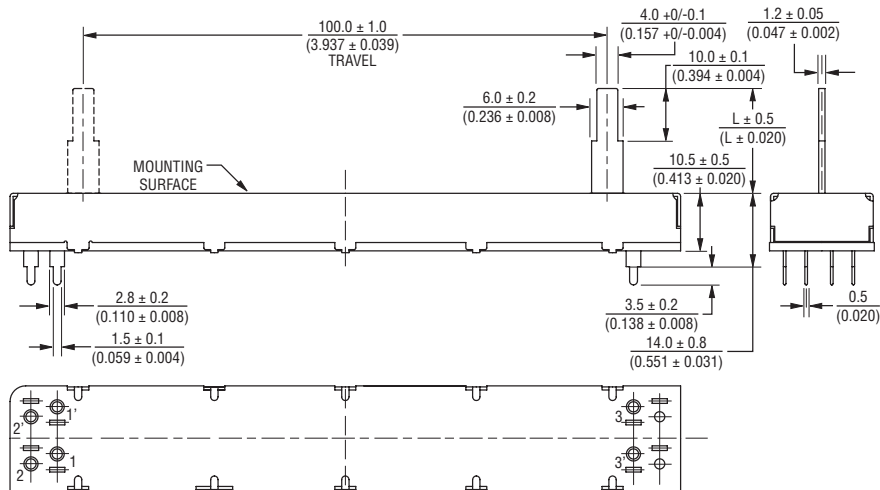
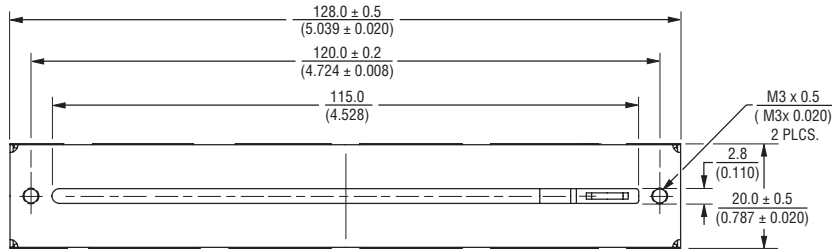

Mounting Hole Detail

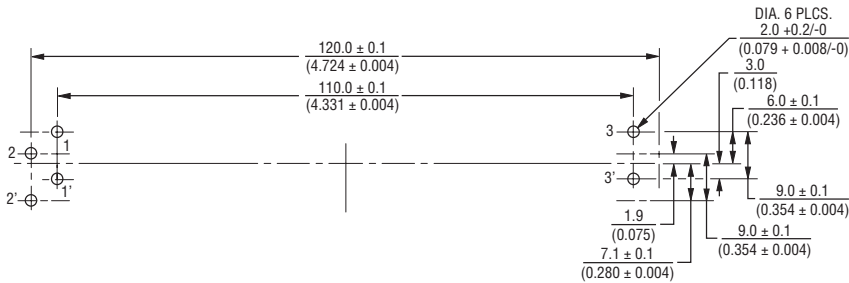

DIMENSIONS: $\frac{MM}{(INCHES)}$

PTF Series Long Life Slide Potentiometer

BOURNS®

Product Dimensions

45 mm Length of Travel
Lever End Style "T"



PTF Series Long Life Slide Potentiometer

BOURNS®

Product Dimensions

60 mm Length of Travel
Lever End Style "T"



Specifications are subject to change without notice.
Customers should verify actual device performance in their specific applications.

PTF Series Long Life Slide Potentiometer

BOURNS®

Product Dimensions

100 mm Length of Travel
Lever End Style "T"

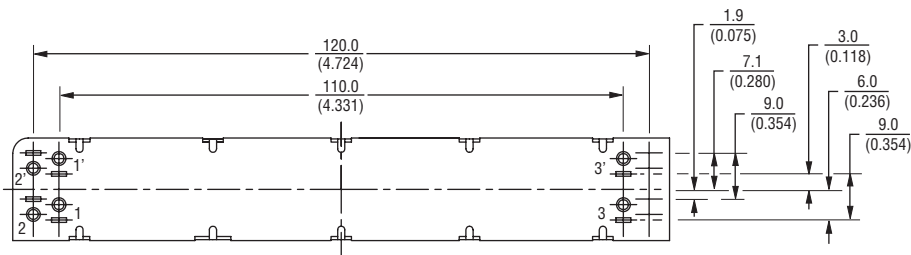

DIMENSIONS: $\frac{MM}{(INCHES)}$

PTF Series Long Life Slide Potentiometer

BOURNS®

Lever End Styles

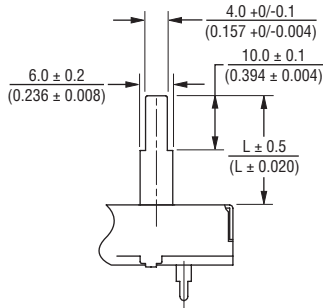

LEVER END STYLE "A"



LEVER END STYLE "B"



LEVER END STYLE "T"

Lever Length (A & B Lever Only)

15.0
(.591)

20.0
(.787)

Tapers

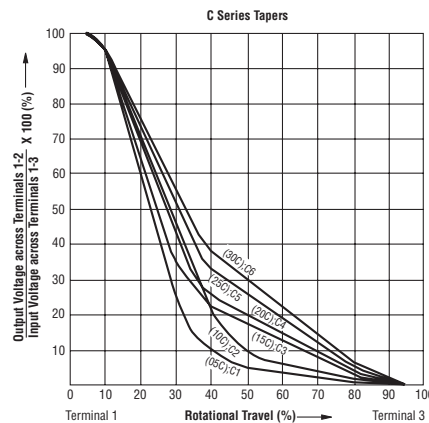

Standard Resistance Table

Resistance (Ohms)	Resistance Code
1,000	102
2,000	202
5,000	502
10,000	103
20,000	203
50,000	503
100,000	104
200,000	204
500,000	504
1,000,000	105

How To Order

PTF 45 - 15 2 A - 103 B2

- Model Number
- Designator
PTF = Long Life Slide Potentiometer
- Length of Travel
45 = 45 mm
60 = 60 mm
01 = 100 mm
- Lever Length
08 = 8.2 mm ("T" Lever Only)
15 = 15 mm ("A" & "B" Lever Only)
20 = 20 mm ("A" & "B" Lever Only)
- No. of Gangs
1 = Single Gang with PC Pins
2 = Dual Gang with PC Pins
3 = Single Gang with Solder Lugs
4 = Dual Gang with Solder Lugs
- Lever End Style
A = Metal Lever (Refer to Drawing)
B = Metal Lever (Refer to Drawing)
T = Metal Lever (Refer to Drawing)
- Resistance Code
(See Standard Resistance Table)
- Resistance Taper (See Taper Charts)
Taper Series followed by Curve Number

Данный компонент на территории Российской Федерации

Вы можете приобрести в компании MosChip.

Для оперативного оформления запроса Вам необходимо перейти по данной ссылке:

<http://moschip.ru/get-element>

Вы можете разместить у нас заказ для любого Вашего проекта, будь то серийное производство или разработка единичного прибора.

В нашем ассортименте представлены ведущие мировые производители активных и пассивных электронных компонентов.

Нашей специализацией является поставка электронной компонентной базы двойного назначения, продукции таких производителей как XILINX, Intel (ex.ALTERA), Vicor, Microchip, Texas Instruments, Analog Devices, Mini-Circuits, Amphenol, Glenair.

Сотрудничество с глобальными дистрибьюторами электронных компонентов, предоставляет возможность заказывать и получать с международных складов практически любой перечень компонентов в оптимальные для Вас сроки.

На всех этапах разработки и производства наши партнеры могут получить квалифицированную поддержку опытных инженеров.

Система менеджмента качества компании отвечает требованиям в соответствии с ГОСТ Р ИСО 9001, ГОСТ РВ 0015-002 и ЭС РД 009

Офис по работе с юридическими лицами:

105318, г.Москва, ул.Щербаковская д.3, офис 1107, 1118, ДЦ «Щербаковский»

Телефон: +7 495 668-12-70 (многоканальный)

Факс: +7 495 668-12-70 (доб.304)

E-mail: info@moschip.ru

Skype отдела продаж:

moschip.ru

moschip.ru_4

moschip.ru_6

moschip.ru_9