

LX8 Series



**Main Features**

Symbol	Value	Unit
$I_{T(RMS)}$	0.8	A
$V_{DRM}/V_{RRM}$	400 to 600	V
$I_{GT}$	3 to 5	mA

**Schematic Symbol**



**Description**

New 0.8 Amp bi-directional solid state switch series offering direct interface to microprocessor drivers in economical TO-92 and surface mount packages. The die voltage blocking junctions are glass-passivated to ensure long term reliability and parametric stability.

**Features & Benefits**

- RoHS compliant and Halogen-Free
- Blocking voltage ( $V_{DRM}$ ) capability — up to 600V
- Surge capability > 9.5Amps
- Static dv/dt > 10 Volts/ $\mu$ sec
- Thru hole and surface mount packages

**Applications**

The LX8 EV Series is especially designed for low current applications such as heating controls in hair care products, as well as replacement of mechanical switch contacts where long life is required.

**Additional Information**



Datasheet



Resources



Samples

**Absolute Maximum Ratings**

Symbol	Parameter	Value	Unit
$I_{T(RMS)}$	RMS on-state current (full sine wave)	TO-92 $T_C = 50^\circ\text{C}$	0.8A A
		SOT-223 $T_L = 90^\circ\text{C}$	
$I_{TSM}$	Non repetitive surge peak on-state current (Single cycle, $T_J$ initial = $25^\circ\text{C}$ )	TO-92 F = 50 Hz	8.0 A
		SOT-223 F = 60 Hz	9.5
$I^2t$	$I^2t$ Value for fusing	$t_p = 10$ ms F = 50 Hz	0.32 A <sup>2</sup> s
		$t_p = 8.3$ ms F = 60 Hz	0.37
di/dt	Critical rate of rise of on-state current $I_G = 2 \times I_{GT}$	TO-92 SOT-223 $T_J = 110^\circ\text{C}$	20 A/ $\mu$ s
$I_{GTM}$	Peak gate current	$t_p = 10$ $\mu$ s $T_J = 110^\circ\text{C}$	1 A
$P_{G(AV)}$	Average gate power dissipation	$T_J = 110^\circ\text{C}$	0.1 W
$T_{stg}$	Storage junction temperature range		-40 to 150 $^\circ\text{C}$
$T_J$	Operating junction temperature range		-40 to 110 $^\circ\text{C}$

**Electrical Characteristics (T<sub>J</sub> = 25°C, unless otherwise specified)**

Symbol	Description	Test Conditions	Quadrant	Limit	Value		Unit
					LX803xy	LX807xy	
I <sub>GT</sub>	DC Gate Trigger Current	V <sub>D</sub> = 12V R <sub>L</sub> = 60 Ω	I – II – III IV	MAX.	3 5	5 7	mA
V <sub>GT</sub>	DC Gate Trigger Voltage		ALL	MAX.	1.3	1.3	V
I <sub>H</sub>	Holding Current	Gate Open		MAX.	5	5	mA
dv/dt	Critical Rate-of-Rise of Off-State Voltage	T <sub>J</sub> = 110°C V <sub>D</sub> = V <sub>DRM</sub> Exponential Waveform Gate Open		MIN.	10	10	V/μs
(dv/dt) <sub>c</sub>	Critical Rate-of-Rise of Commutating Voltage	(di/dt) <sub>c</sub> = 0.43A/ms T <sub>J</sub> = 110°C		MIN.	1.5	1.5	V/μs
t <sub>gt</sub>	Turn-On Time	I <sub>G</sub> = 25mA PW = 15μs I <sub>T</sub> = 1.2A (pk)		MAX.	2.0	2.0	μs

NOTE: x = voltage, y = package

**Static Characteristics (T<sub>J</sub> = 25°C, unless otherwise specified)**

Symbol	Description	Test Conditions	Limit	Value	Unit
V <sub>TM</sub>	Peak On-State Voltage	I <sub>TM</sub> = 1.13A (pk)	MAX	1.60	V
I <sub>DRM</sub>	Off-State Current, Peak Repetitive	V <sub>D</sub> = V <sub>DRM</sub> T <sub>J</sub> = 25°C	MAX	5	μA
		V <sub>D</sub> = V <sub>DRM</sub> T <sub>J</sub> = 110°C		100	μA

**Thermal Resistances**

Symbol	Description	Test Conditions	Value	Unit	
R <sub>th(j-c)</sub>	Junction to case (AC)	I <sub>T</sub> = 0.8A <sub>(RMS)</sub> <sup>1</sup>	TO-92	60	°C/W
			SOT-223	25	
R <sub>th(j-a)</sub>	Junction to ambient	I <sub>T</sub> = 0.8A <sub>(RMS)</sub> <sup>1</sup>	TO-92	150	°C/W
			SOT-223	60	

<sup>1</sup> 60Hz AC resistive load condition, 100% conduction.

**Figure 1: Definition of Quadrants**

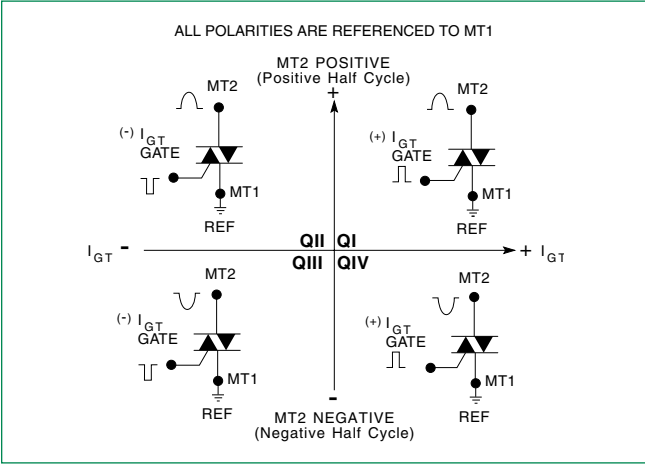

**Figure 2: Normalized DC Gate Trigger Current for All Quadrants vs. Junction Temperature**

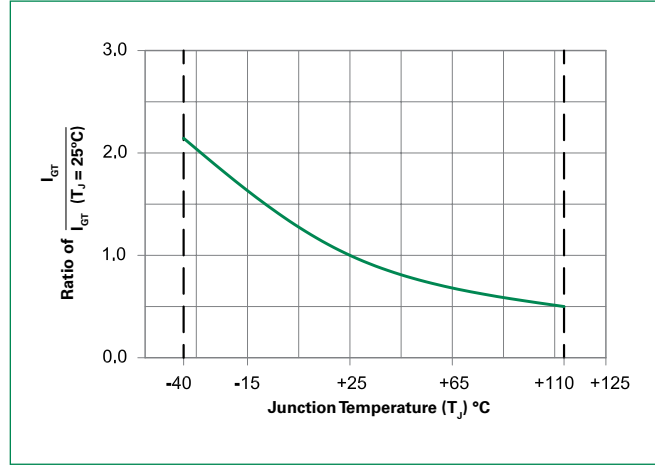

**Figure 3: Normalized DC Holding Current vs. Junction Temperature**

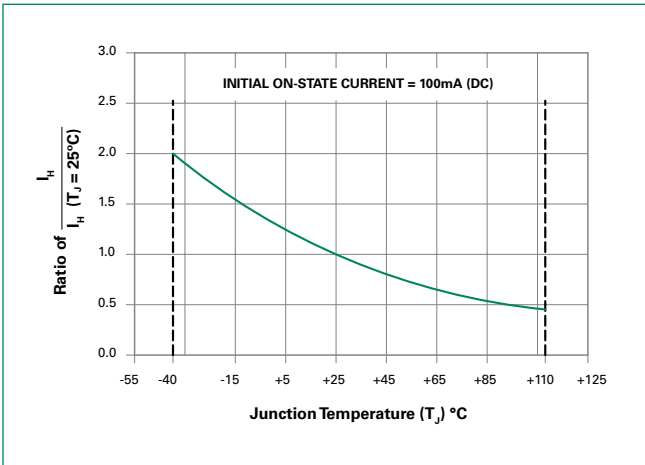

**Figure 4: Normalized DC Gate Trigger Voltage for All Quadrants vs. Junction Temperature**

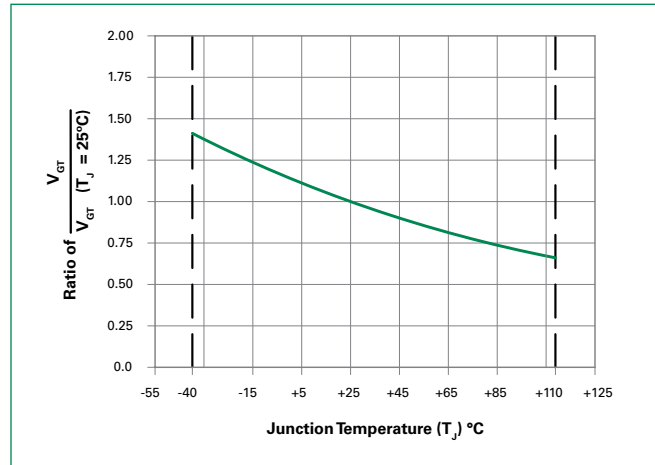

**Figure 5: Power Dissipation (Typical) vs. RMS On-State Current**

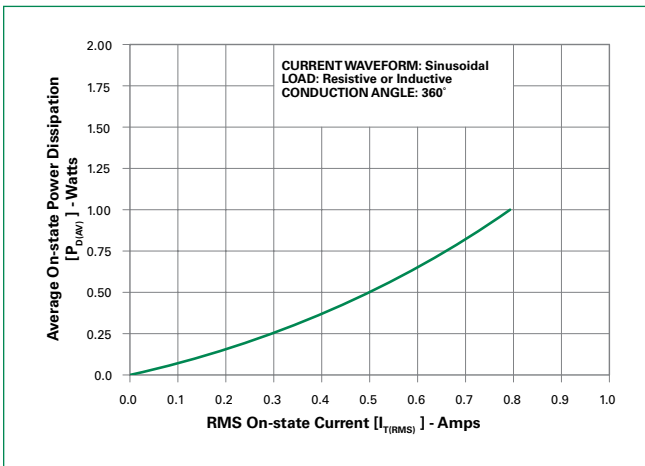

**Figure 6: Maximum Allowable Case Temperature vs. On-State Current**

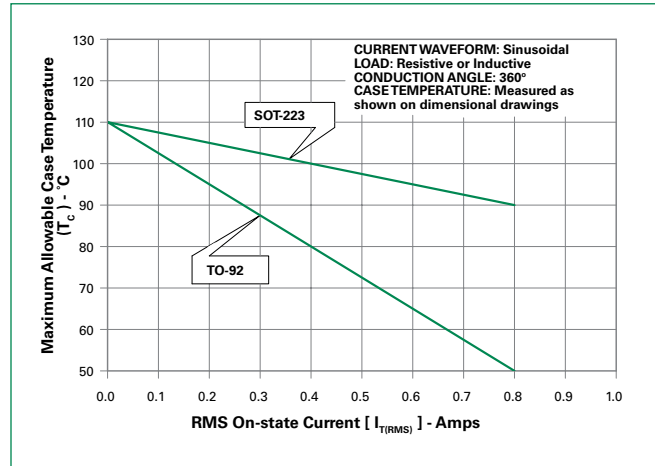

**Figure 7: Surge Peak On-State Current vs. Number of Cycles**



**Soldering Parameters**

Reflow Condition		Pb – Free assembly
Pre Heat	- Temperature Min ( $T_{s(min)}$ )	150°C
	- Temperature Max ( $T_{s(max)}$ )	200°C
	- Time (min to max) ( $t_s$ )	60 – 180 secs
Average ramp up rate (Liquidus Temp) ( $T_L$ ) to peak		5°C/second max
$T_{s(max)}$ to $T_L$ - Ramp-up Rate		5°C/second max
Reflow	- Temperature ( $T_L$ ) (Liquidus)	217°C
	- Time (min to max) ( $t_s$ )	60 – 150 seconds
Peak Temperature ( $T_p$ )		260 <sup>+0/-5</sup> °C
Time within 5°C of actual peak Temperature ( $t_p$ )		20 – 40 seconds
Ramp-down Rate		5°C/second max
Time 25°C to peak Temperature ( $T_p$ )		8 minutes Max.
Do not exceed		280°C



**Physical Specifications**

<b>Terminal Finish</b>	100% Matte Tin-plated.
<b>Body Material</b>	UL recognized epoxy meeting flammability classification 94V-0.
<b>Lead Material</b>	Copper Alloy

**Design Considerations**

Careful selection of the correct device for the application's operating parameters and environment will go a long way toward extending the operating life of the Thyristor. Good design practice should limit the maximum continuous current through the main terminals to 75% of the device rating. Other ways to ensure long life for a power discrete semiconductor are proper heat sinking and selection of voltage ratings for worst case conditions. Overheating, overvoltage (including dv/dt), and surge currents are the main killers of semiconductors. Correct mounting, soldering, and forming of the leads also help protect against component damage.

**Reliability/Environmental Tests**

Test	Specifications and Conditions
<b>AC Blocking</b>	MIL-STD-750, M-1040, Cond A Applied Peak AC voltage @ 110°C for 1008 hours
<b>Temperature Cycling</b>	MIL-STD-750, M-1051, 100 cycles; -40°C to +150°C; 15-min dwell-time
<b>Temperature/Humidity</b>	EIA / JEDEC, JESD22-A101 1008 hours; 320V - DC: 85°C; 85% rel humidity
<b>High Temp Storage</b>	MIL-STD-750, M-1031, 1008 hours; 150°C
<b>Low-Temp Storage</b>	1008 hours; -40°C
<b>Resistance to Solder Heat</b>	MIL-STD-750 Method 2031
<b>Solderability</b>	ANSI/J-STD-002, category 3, Test A
<b>Lead Bend</b>	MIL-STD-750, M-2036 Cond E

**Dimensions — TO-92 (E Package)**



Dimensions	Inches		Millimeters	
	Min	Max	Min	Max
A	0.175	0.205	4.450	5.200
B	0.170	0.210	4.320	5.330
C	0.500		12.70	
D	0.135		3.430	
E	0.125	0.165	3.180	4.190
F	0.080	0.105	2.040	2.660
G	0.016	0.021	0.407	0.533
H	0.045	0.055	1.150	1.390
I	0.095	0.105	2.420	2.660
J	0.015	0.020	0.380	0.500

**Dimensions – SOT-223**

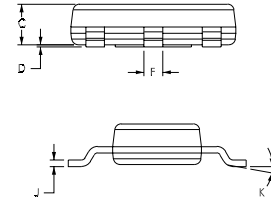
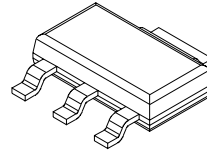

**Pad Layout for SOT-223**



Dimensions in Millimeters (Inches)

Dimensions	Inches			Millimeters		
	Min	Typ	Max	Min	Typ	Max
A	0.248	0.256	0.264	6.30	6.50	6.70
B	0.130	0.138	0.146	3.30	3.50	3.70
C	—	—	0.071	—	—	1.80
D	0.001	—	0.004	0.02	—	0.10
E	0.114	0.118	0.124	2.90	3.00	3.15
F	0.024	0.027	0.034	0.60	0.70	0.85
G	—	0.090	—	—	2.30	—
H	—	0.181	—	—	4.60	—
I	0.264	0.276	0.287	6.70	7.00	7.30
J	0.009	0.010	0.014	0.24	0.26	0.35
K	10° MAX					

**Product Selector**

Part Number	Voltage	Gate Sensitivity Quadrants		Package
		I – II – III	IV	
LX803DE	400 V	3 mA	5 mA	TO-92
LX803ME	600 V	3 mA	5 mA	TO-92
LX803DT	400 V	3 mA	5 mA	SOT-223
LX803MT	600 V	3 mA	5 mA	SOT-223
LX807DE	400 V	5 mA	7 mA	TO-92
LX807ME	600 V	5 mA	7 mA	TO-92
LX807DT	400 V	5 mA	7 mA	SOT-223
LX807MT	600 V	5 mA	7 mA	SOT-223

**Packing Options**

Part Number	Marking	Weight	Packing Mode	Base Quantity
LX8xyE	LX8xyE	0.217 g	Bulk	2500
LX8xyEAP	LX8xyE	0.217 g	Ammo Pack	2000
LX8xyERP	LX8xyE	0.217 g	Tape & Reel	2000
LX8xyTRP	LX8xyT	0.120 g	Tape & Reel	1000

Note: xx = gate sensitivity, y = voltage

**TO-92 (3-lead) Reel Pack (RP) Radial Leaded Specifications**

Meets all EIA-468-C Standards



**TO-92 (3-lead) Ammo Pack (AP) Radial Leaded Specifications**

Meets all EIA-468-C Standards



**SOT-223 Reel Pack (RP) Specifications**



**Part Numbering System**



**Part Marking System**





## Данный компонент на территории Российской Федерации

### Вы можете приобрести в компании MosChip.

Для оперативного оформления запроса Вам необходимо перейти по данной ссылке:

<http://moschip.ru/get-element>

Вы можете разместить у нас заказ для любого Вашего проекта, будь то серийное производство или разработка единичного прибора.

В нашем ассортименте представлены ведущие мировые производители активных и пассивных электронных компонентов.

Нашей специализацией является поставка электронной компонентной базы двойного назначения, продукции таких производителей как XILINX, Intel (ex.ALTERA), Vicor, Microchip, Texas Instruments, Analog Devices, Mini-Circuits, Amphenol, Glenair.

Сотрудничество с глобальными дистрибьюторами электронных компонентов, предоставляет возможность заказывать и получать с международных складов практически любой перечень компонентов в оптимальные для Вас сроки.

На всех этапах разработки и производства наши партнеры могут получить квалифицированную поддержку опытных инженеров.

Система менеджмента качества компании отвечает требованиям в соответствии с ГОСТ Р ИСО 9001, ГОСТ РВ 0015-002 и ЭС РД 009

### Офис по работе с юридическими лицами:

105318, г.Москва, ул.Щербаковская д.3, офис 1107, 1118, ДЦ «Щербаковский»

Телефон: +7 495 668-12-70 (многоканальный)

Факс: +7 495 668-12-70 (доб.304)

E-mail: [info@moschip.ru](mailto:info@moschip.ru)

Skype отдела продаж:

moschip.ru

moschip.ru\_4

moschip.ru\_6

moschip.ru\_9