



SinglFuse™ SF-3812TM-T Series Features

- Replacement for Bourns® Telefuse™ models B0500T, B1250T and B2000T
- For use in telecommunication circuit applications requiring low current protection with high surge tolerance
- Overcurrent protection to Telcordia GR-1089-CORE Issue 4 & UL 60950
- EIA 3812 (10030 metric) footprint
- UL 248-14 listed
- Surface mount packaging for automated assembly
- RoHS compliant* and halogen free**

SF-3812TM-T Series – SinglFuse™ Telefuse™ Telecom Protectors

Electrical Characteristics

Model	Rated Current (Amps)	Fusing Time	Resistance (Ω) Typ.***	Rated Voltage	Interrupting Rating	Typical I ² t (A ² s) ****	Max. Power Dissipation (W)
SF-3812TM050T-2	0.50	Open within 1~120 sec. at 250 % rated current	0.480	600 VAC	60 A @ 600 VAC	1.4	0.4
SF-3812TM125T-2	1.25		0.100		60 A @ 250 VAC	22	0.6
SF-3812TM200T-2	2.00		0.055		50 A @ 250 VDC	24	0.8

*** Resistance value measured with ≤10 % rated current at 25 °C ambient. Tolerance ±30 %.

**** Melting I²t calculated at 10 times rated current.

Reliability Testing

No.	Test	Test Condition	Requirement	Test Reference
1	Solderability	Temperature setup: 235 ±5 °C Time setup: 10 ±1 sec.	After test terminal electrode wetting area must be greater than 95 %	IEC 60068-2-58
2	Resistance to soldering heat	Temperature setup: 235 ±5 °C Time setup: 30 ± 5 sec.	DCR change ≤ ±15 %	IEC 60068-2-58
3	Thermal shock	Temperature setup: 25 °C ~ -65 °C ~ 25 °C ~ 125 °C Time setup: -65 °C (30 min) ~ 25 °C (5 min) ~ 125 °C (30 min) ~ 25 °C (5 min), 5 cycles	DCR change ≤ ±15 % No mechanical damage	MIL-STD-202G Method 107G Test Condition B
4	Humidity unload	Heat (85 ±0.5 °C) High Humidity (85 ±1 % RH) 240 hours	DCR change ≤ ±15 % No mechanical damage	MIL-STD-202G Method 103B Test Condition A
5	Salt spray	Salt spray concentration: 5 ±1 % Test liquid temperature: 35 ±0.5 °C 96 hours	DCR change ≤ ±15 % No mechanical damage	MIL-STD-202G Method 101E Test Condition A
6	Bending	The board shall be bent by 1 mm at a rate of 1 mm/sec.	DCR change ≤ ±15 %	IEC 60127-4
7	Vibration	Frequency setup: 10 ~ 55 ~ 10 Hz Time setup: 1 Minute/cycle (X-Y-Z, 120 cycles, 6 hours)	DCR change ≤ ±15 % No mechanical damage	MIL-STD-202G Method 201A

Agency Recognition

UL File NumberE198545

BOURNS®

Asia-Pacific: Tel: +886-2 2562-4117 • Email: asiacus@bourns.com

EMEA: Tel: +36 88 520 390 • Email: eurocus@bourns.com

The Americas: Tel: +1-951 781-5500 • Email: americus@bourns.com

www.bourns.com



WARNING Cancer and Reproductive Harm

www.P65Warnings.ca.gov

* RoHS Directive 2002/95/EC Jan. 27, 2003 including annex and RoHS Recast 2011/65/EU June 8, 2011.

** Bourns considers a product to be "halogen free" if (a) the Bromine (Br) content is 900 ppm or less; (b) the Chlorine (Cl) content is 900 ppm or less; and (c) the total Bromine (Br) and Chlorine (Cl) content is 1500 ppm or less.

"SinglFuse" is a trademark of Bourns, Inc.

Specifications are subject to change without notice.

The device characteristics and parameters in this data sheet can and do vary in different applications and actual device performance may vary over time.

Users should verify actual device performance in their specific applications.

SinglFuse™ SF-3812TM-T Series Applications

- Telecom and networking equipment surge protection
- T1/E1/J1
- 10/100/1000BaseT Ethernet
- xDSL (VDSL/VDSL2+, ADSL/ADSL2+)
- Fiber to the Curb (FTTC) SLIC
- Fiber to the Premises (FTTP) SLIC
- POTS systems

SF-3812TM-T Series – SinglFuse™ Telefuse™ Telecom Protectors



Environmental Characteristics

Operating Temperature.....-55 °C to +125 °C
 Storage Conditions
 Temperature +15 °C to +30 °C
 Humidity..... 20 % to 70 %
 Shelf Life.....2 years from manufacturing date
 Moisture Sensitivity Level..... 1
 ESD Classification (HBM)..... Class 6

Typical Part Marking

Represents total content. Layout may vary.



Rated Current	Part Marking
0.5 A	0.5
1.25 A	1.25
2.0 A	2.0

How to Order

SF - 3812 TM 050 T - 2

SinglFuse™ _____
 Product Designator _____
 SMD Footprint _____
 3812 = EIA 3812
 (10030 metric) _____
 Fuse Blow Type _____
 TM = Time Lag, Telecom _____
 Rated Current _____
 050 ~ 200 (0.50 A ~ 2.00 A) _____
 Structure Type _____
 T = Ceramic Tube _____
 Packaging Type _____
 - 2 = Tape & Reel _____

Construction

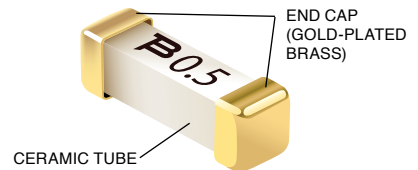

Packaging Quantity

2,500 pieces per 13-inch reel

Product Dimensions

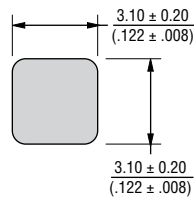
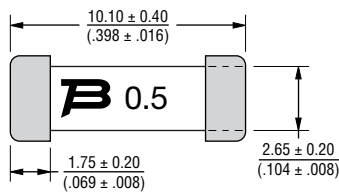

DIMENSIONS: $\frac{\text{MM}}{\text{(INCHES)}}$

Recommended Pad Layout

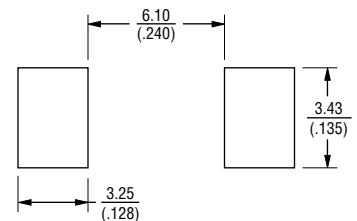

DIMENSIONS: $\frac{\text{MM}}{\text{(INCHES)}}$

Specifications are subject to change without notice. Users should verify actual device performance in their specific applications. The products described herein and this document are subject to specific legal disclaimers as set forth on the last page of this document, and at www.bourns.com/docs/legal/disclaimer.pdf.

Current Rating Thermal Derating Curve

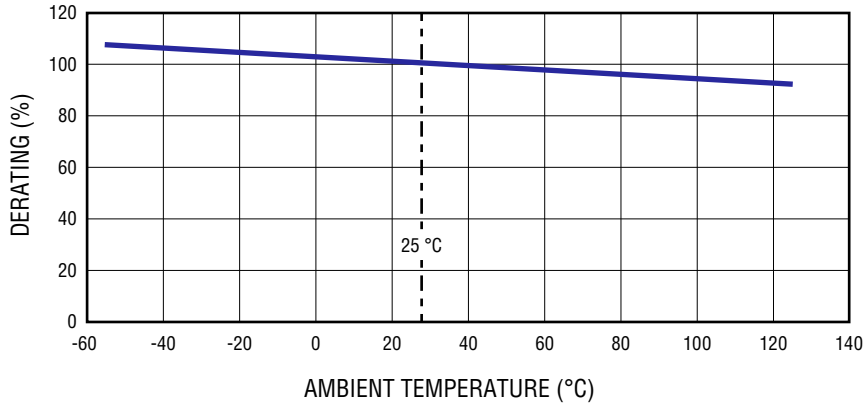

Pulse Cycle Withstand Capability

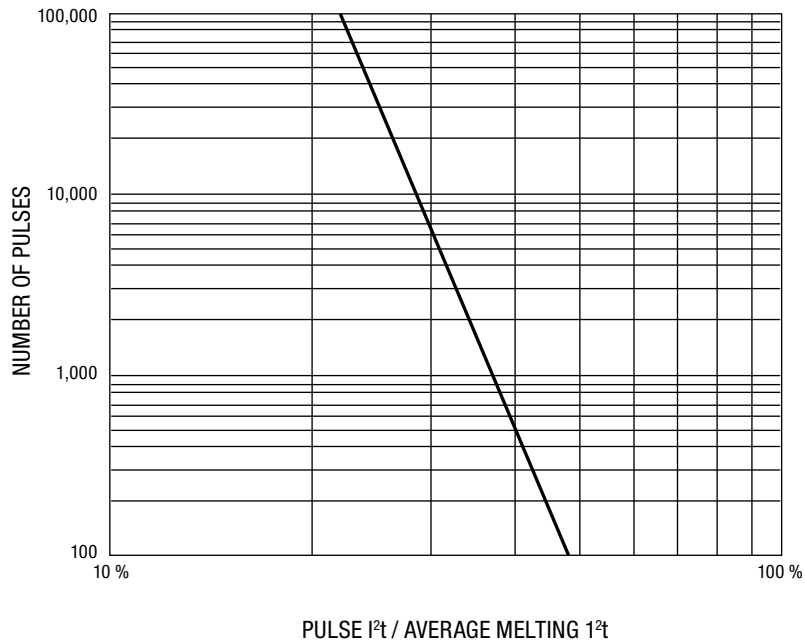

Solder Reflow Recommendations

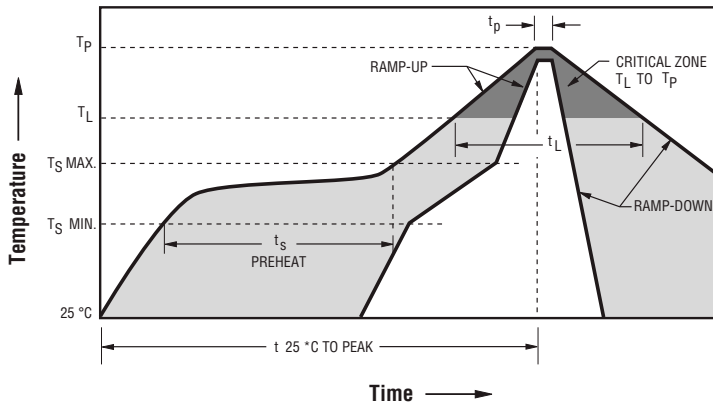

Profile Feature	Pb-Free Assembly
Preheat / Soak: Temperature Min. (T_{smin}) Temperature Max. (T_{smax}) Time (t_s) from (T_{smin} to T_{smax})	150 °C 200 °C 60~180 seconds
Ramp Up Rate (T_L to T_p)	3 °C / second max.
Ramp Up Rate (T_{smax} to T_L)	5 °C / second max.
Liquidous Temperature (T_L) Time (t_L) maintained above T_L	217 °C 60~90 seconds
Peak Package Body Temperature (T_p)	235 °C ± 5 °C
Time within 5 °C of actual peak temperature (T_p)	20~30 seconds*
Ramp Down Rate (T_p to T_L)	6 °C / second max.
Time 25 °C to Peak Temperature	8 minutes max.
Do not exceed	240 °C

* Tolerance for peak profile temperature (T_p) is defined as a supplier minimum and a user maximum.

Solder Wave Recommendations

Peak Temperature (Dwell Time)

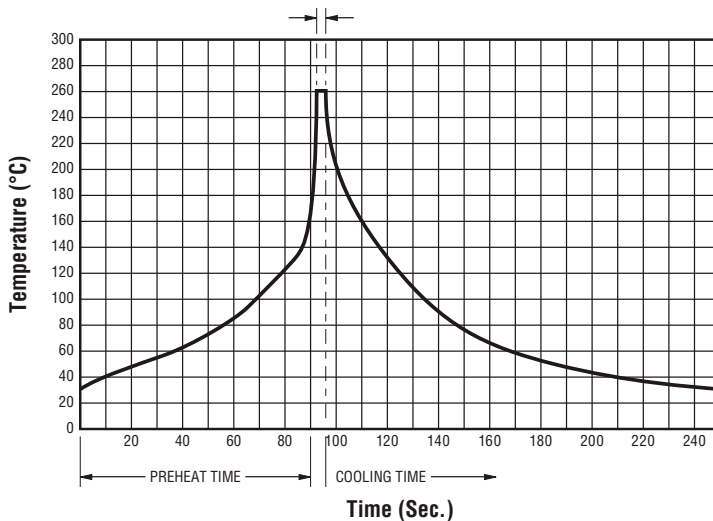

Profile Feature	Pb-Free Assembly
Preheat: Temperature Max. (T_{smax}) Time (Min. to Max.)	150 °C 60~90 seconds
Solder Pot Temperature	260 °C max.
Solder Dwell Time	2~3 seconds

Specifications are subject to change without notice.

Users should verify actual device performance in their specific applications.

The products described herein and this document are subject to specific legal disclaimers as set forth on the last page of this document, and at www.bourns.com/docs/legal/disclaimer.pdf.

Average Pre-Arcing Time vs. Current Curves

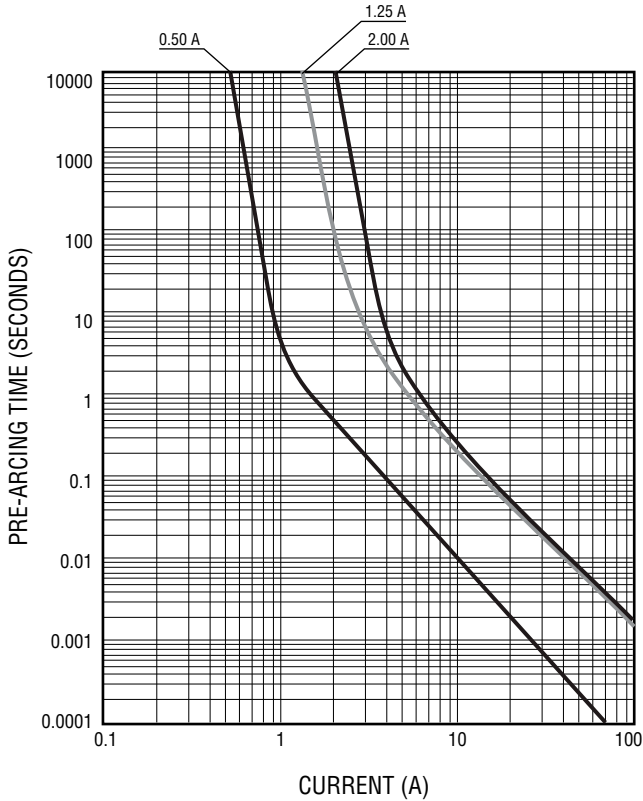

Average I²t vs. t Curves

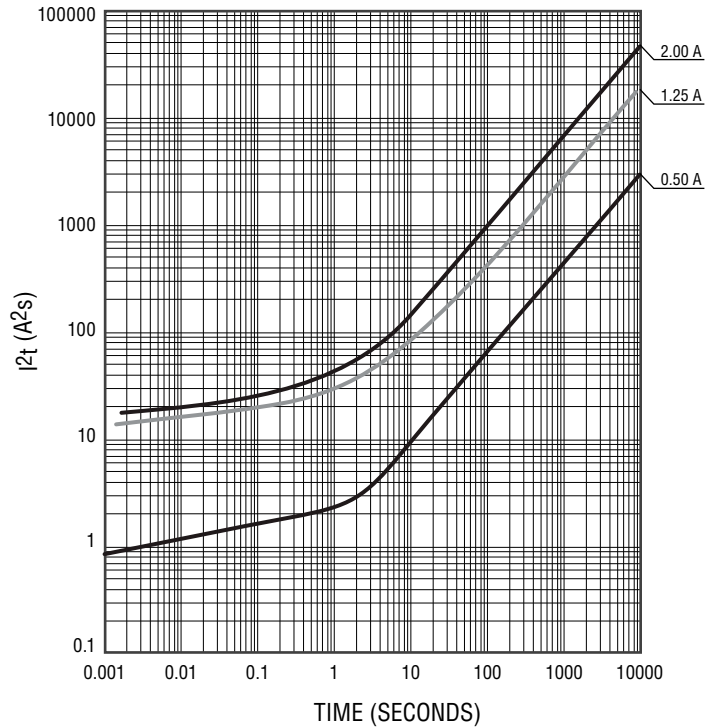

Lightning Surge Specifications (Fuse Not Allowed to Open)

Surge Specification	Max. Rise / Min. Decay (μ sec.)	Min. Peak Current (A)	Min. Peak Voltage (V)	Repetitions Each Polarity	Recommended Fuse (A)
Telcordia GR-1089	10 / 1000	100	600	25	1.25 / 2.00
		100	1000	25	1.25 / 2.00
	10 / 360	100	1000	25	1.25 / 2.00
		25	1000	5	0.50 / 1.25 / 2.00
	2 / 10	500	2500	10	1.25 / 2.00
		500	5000	1	1.25 / 2.00
8 / 20	300	5000	1	1.25 / 2.00	

Specifications are subject to change without notice.

Users should verify actual device performance in their specific applications.

The products described herein and this document are subject to specific legal disclaimers as set forth on the last page of this document, and at www.bourns.com/docs/legal/disclaimer.pdf.

Lightning Surge Specifications (Fuse Not Allowed to Open)

Surge Specification	Surge	Waveform (μ sec.)	Current (A)	Voltage (V)	Repetitions (Each)	Recommended Fuse (A)
FCC Part 68 (TIA-968-A)	Metallic A	10 x 560	100	800	1	1.25 / 2.00
	Longitudinal A	10 x 160	200	1500	1	1.25 / 2.00

Surge Specification	Surge	Waveform (μ sec.)	Current (A)	Voltage (V)	Repetitions (Each)	Recommended Fuse (A)
UL / EN 60950 (ITU-T K20)	Impulse Non-handheld	10 x 700	37.5	1500	5	0.50 / 1.25 / 2.00

AC Power Fault Tests (Fuse Not Allowed to Open)

GR-1089 1st Level Test	Voltage (Vrms)	Short Circuit Current (A)	Hits	Duration	Recommended Fuse (A)
1	50	0.33	1	15 min.	0.50 / 1.25 / 2.00
2	100	0.17	1	15 min.	0.50 / 1.25 / 2.00
3	200 / 400 / 600	1.00	60	1.0 sec.	0.50 / 1.25 / 2.00
4	1000	1.00	60	1.0 sec.	0.50 / 1.25 / 2.00
5	600	0.50	1	30.0 sec.	0.50 / 1.25 / 2.00
6	440	2.20	5	2.0 sec.	1.25 / 2.00
7	600	3.00	1	1.1 sec.	1.25 / 2.00
8	1000	5.00	1	0.4 sec	1.25 / 2.00

AC Current Limiting Protector Tests / Fusing Coordination Tests

Voltage (V_{AC})	Current (A)	Duration	Maximum Time For Fuse to Open (seconds)		
			0.50 A	1.25 A	2.00 A
600	2.20	up to 15 min.	1.0	will not open	will not open
	2.60		0.8	900	will not open
	3.00		0.5	20	will not open
	3.75		0.3	10	20
	5.00		0.2	4	10
	7.00		0.1	2	4
	10.00		0.05	1	1.2
	12.50		0.03	0.40	0.6
	20.00		0.01	0.14	0.2
	25.00		0.008	0.08	0.14
30.00	0.006	0.04	0.10		

Specifications are subject to change without notice.

Users should verify actual device performance in their specific applications.

The products described herein and this document are subject to specific legal disclaimers as set forth on the last page of this document, and at www.bourns.com/docs/legal/disclaimer.pdf.

Packaging Specifications

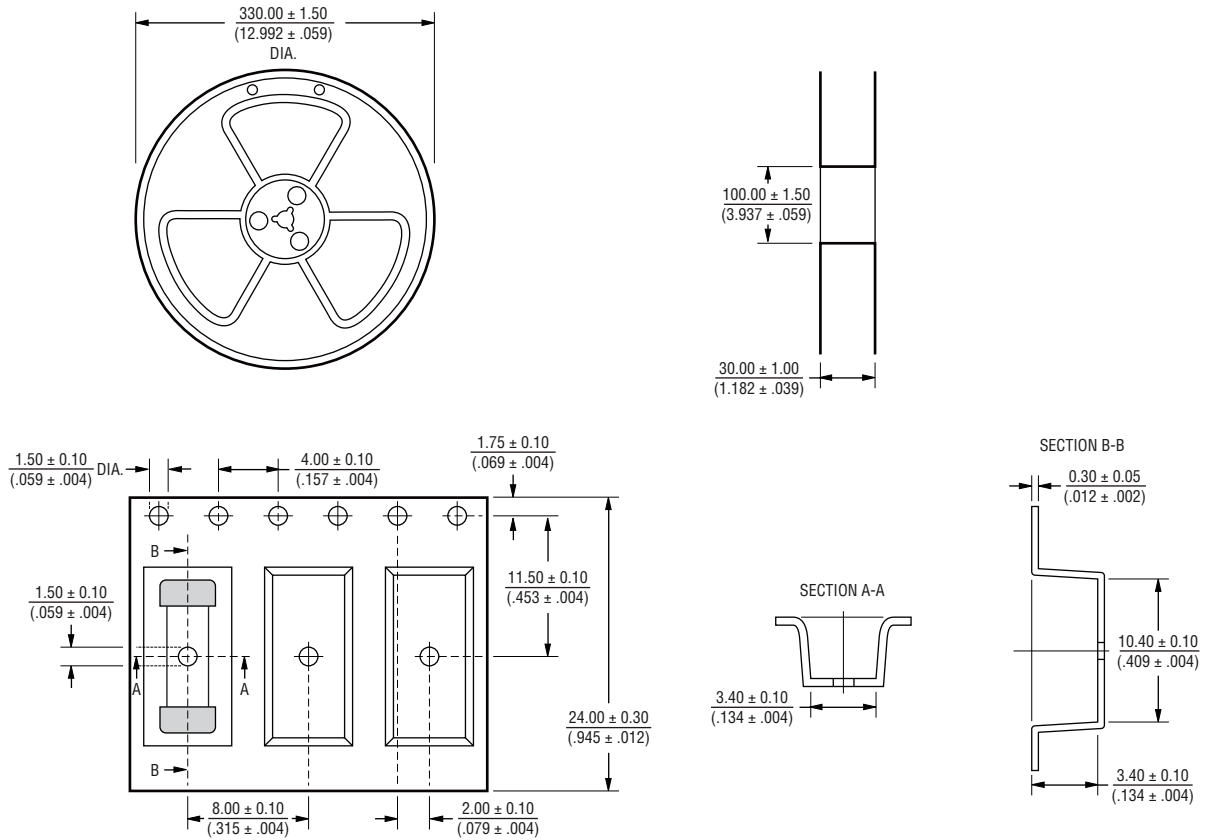

DIMENSIONS: $\frac{\text{MM}}{\text{(INCHES)}}$

REV. 12/18

Specifications are subject to change without notice.

Users should verify actual device performance in their specific applications.

The products described herein and this document are subject to specific legal disclaimers as set forth on the last page of this document, and at www.bourns.com/docs/legal/disclaimer.pdf.

This legal disclaimer applies to purchasers and users of Bourns® products manufactured by or on behalf of Bourns, Inc. and its affiliates (collectively, “Bourns”).

Unless otherwise expressly indicated in writing, Bourns® products and data sheets relating thereto are subject to change without notice. Users should check for and obtain the latest relevant information and verify that such information is current and complete before placing orders for Bourns® products.

The characteristics and parameters of a Bourns® product set forth in its data sheet are based on laboratory conditions, and statements regarding the suitability of products for certain types of applications are based on Bourns’ knowledge of typical requirements in generic applications. The characteristics and parameters of a Bourns® product in a user application may vary from the data sheet characteristics and parameters due to (i) the combination of the Bourns® product with other components in the user’s application, or (ii) the environment of the user application itself. The characteristics and parameters of a Bourns® product also can and do vary in different applications and actual performance may vary over time. Users should always verify the actual performance of the Bourns® product in their specific devices and applications, and make their own independent judgments regarding the amount of additional test margin to design into their device or application to compensate for differences between laboratory and real world conditions.

Unless Bourns has explicitly designated an individual Bourns® product as meeting the requirements of a particular industry standard (e.g., ISO/TS 16949) or a particular qualification (e.g., UL listed or recognized), Bourns is not responsible for any failure of an individual Bourns® product to meet the requirements of such industry standard or particular qualification. Users of Bourns® products are responsible for ensuring compliance with safety-related requirements and standards applicable to their devices or applications.

Bourns® products are not recommended, authorized or intended for use in nuclear, lifesaving, life-critical or life-sustaining applications, nor in any other applications where failure or malfunction may result in personal injury, death, or severe property or environmental damage. Unless expressly and specifically approved in writing by two authorized Bourns representatives on a case-by-case basis, use of any Bourns® products in such unauthorized applications might not be safe and thus is at the user’s sole risk. Life-critical applications include devices identified by the U.S. Food and Drug Administration as Class III devices and generally equivalent classifications outside of the United States.

Bourns expressly identifies those Bourns® standard products that are suitable for use in automotive applications on such products’ data sheets in the section entitled “Applications.” Unless expressly and specifically approved in writing by two authorized Bourns representatives on a case-by-case basis, use of any other Bourns® standard products in an automotive application might not be safe and thus is not recommended, authorized or intended and is at the user’s sole risk. If Bourns expressly identifies a sub-category of automotive application in the data sheet for its standard products (such as infotainment or lighting), such identification means that Bourns has reviewed its standard product and has determined that if such Bourns® standard product is considered for potential use in automotive applications, it should only be used in such sub-category of automotive applications. Any reference to Bourns® standard product in the data sheet as compliant with the AEC-Q standard or “automotive grade” does not by itself mean that Bourns has approved such product for use in an automotive application.

Bourns® standard products are not tested to comply with United States Federal Aviation Administration standards generally or any other generally equivalent governmental organization standard applicable to products designed or manufactured for use in aircraft or space applications. Bourns expressly identifies Bourns® standard products that are suitable for use in aircraft or space applications on such products’ data sheets in the section entitled “Applications.” Unless expressly and specifically approved in writing by two authorized Bourns representatives on a case-by-case basis, use of any other Bourns® standard product in an aircraft or space application might not be safe and thus is not recommended, authorized or intended and is at the user’s sole risk.

The use and level of testing applicable to Bourns® custom products shall be negotiated on a case-by-case basis by Bourns and the user for which such Bourns® custom products are specially designed. Absent a written agreement between Bourns and the user regarding the use and level of such testing, the above provisions applicable to Bourns® standard products shall also apply to such Bourns® custom products.

Users shall not sell, transfer, export or re-export any Bourns® products or technology for use in activities which involve the design, development, production, use or stockpiling of nuclear, chemical or biological weapons or missiles, nor shall they use Bourns® products or technology in any facility which engages in activities relating to such devices. The foregoing restrictions apply to all uses and applications that violate national or international prohibitions, including embargos or international regulations. Further, Bourns® products and Bourns technology and technical data may not under any circumstance be exported or re-exported to countries subject to international sanctions or embargoes. Bourns® products may not, without prior authorization from Bourns and/or the U.S. Government, be resold, transferred, or re-exported to any party not eligible to receive U.S. commodities, software, and technical data.

To the maximum extent permitted by applicable law, Bourns disclaims (i) any and all liability for special, punitive, consequential, incidental or indirect damages or lost revenues or lost profits, and (ii) any and all implied warranties, including implied warranties of fitness for particular purpose, non-infringement and merchantability.

For your convenience, copies of this Legal Disclaimer Notice with German, Spanish, Japanese, Traditional Chinese and Simplified Chinese bilingual versions are available at:

Web Page: <http://www.bourns.com/legal/disclaimers-terms-and-policies>

PDF: <http://www.bourns.com/docs/Legal/disclaimer.pdf>

Данный компонент на территории Российской Федерации

Вы можете приобрести в компании MosChip.

Для оперативного оформления запроса Вам необходимо перейти по данной ссылке:

<http://moschip.ru/get-element>

Вы можете разместить у нас заказ для любого Вашего проекта, будь то серийное производство или разработка единичного прибора.

В нашем ассортименте представлены ведущие мировые производители активных и пассивных электронных компонентов.

Нашей специализацией является поставка электронной компонентной базы двойного назначения, продукции таких производителей как XILINX, Intel (ex.ALTERA), Vicor, Microchip, Texas Instruments, Analog Devices, Mini-Circuits, Amphenol, Glenair.

Сотрудничество с глобальными дистрибьюторами электронных компонентов, предоставляет возможность заказывать и получать с международных складов практически любой перечень компонентов в оптимальные для Вас сроки.

На всех этапах разработки и производства наши партнеры могут получить квалифицированную поддержку опытных инженеров.

Система менеджмента качества компании отвечает требованиям в соответствии с ГОСТ Р ИСО 9001, ГОСТ РВ 0015-002 и ЭС РД 009

Офис по работе с юридическими лицами:

105318, г.Москва, ул.Щербаковская д.3, офис 1107, 1118, ДЦ «Щербаковский»

Телефон: +7 495 668-12-70 (многоканальный)

Факс: +7 495 668-12-70 (доб.304)

E-mail: info@moschip.ru

Skype отдела продаж:

moschip.ru

moschip.ru_4

moschip.ru_6

moschip.ru_9