

## Rail-to-rail, high output current, dual operational amplifier

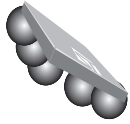

Flip-chip with backcoating

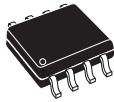

SO8

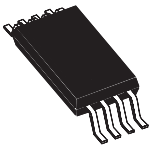

TSSOP8

Product status link

[TS922 and TS922A](#)

### Features

- Rail-to-rail input and output
- Low noise: 9 nV/√Hz
- Low distortion
- High output current: 80 mA (able to drive 32 Ω loads)
- High-speed: 4 MHz, 1 V/μs
- Operating from 2.7 to 12 V
- Low input offset voltage: 900 μV max. (TS922A)
- ESD internal protection: 2 kV
- Latch-up immunity

### Applications

- Line drivers and actuator drivers
- Portable speakers
- Instrumentation with low noise as key factor
- Multimedia systems and portable equipments

### Description

The [TS922](#) and the [TS922A](#) devices are rail-to-rail dual BiCMOS operational amplifiers optimized and fully specified for 3 V and 5 V operations. These devices have high output currents which allow low-load impedances to be driven.

Very low noise, low distortion, low offset, and a high output current capability make these devices an excellent choice for high quality, low voltage, or battery operated audio systems.

The devices are stable for capacitive loads up to 500 pF.

# 1 Pin diagrams

Figure 1. Pinout for Flip-chip package (top view)



Figure 2. Pin connections for SO8 and TSSOP8 (top view)



## 2 Absolute maximum ratings and operating conditions

**Table 1. Absolute maximum ratings (AMR)**

| Symbol     | Parameter                                             | Value                                  | Unit |      |
|------------|-------------------------------------------------------|----------------------------------------|------|------|
| $V_{CC}$   | Supply voltage <sup>(1)</sup>                         | 14                                     | V    |      |
| $V_{id}$   | Differential input voltage <sup>(2)</sup>             | $\pm 1$                                |      |      |
| $V_{in}$   | Input voltage <sup>(3)</sup>                          | $(V_{CC-}) - 0.3$ to $(V_{CC+}) + 0.3$ |      |      |
| $T_{stg}$  | Storage temperature                                   | -65 to 150                             | °C   |      |
| $T_j$      | Maximum junction temperature                          | 150                                    |      |      |
| —          | Soldering temperature (10 s), leaded version          | 250                                    |      |      |
| —          | Soldering temperature (10 s), unleaded version        | 260                                    |      |      |
| $R_{thja}$ | Thermal resistance junction-to-ambient <sup>(4)</sup> | Flip-chip                              | 90   | °C/W |
|            |                                                       | SO8                                    | 125  |      |
|            |                                                       | TSSOP8                                 | 120  |      |
| $R_{thjc}$ | Thermal resistance junction-to-case <sup>(4)</sup>    | SO8                                    | 40   |      |
|            |                                                       | TSSOP8                                 | 37   |      |
| ESD        | HBM: human body model <sup>(5)</sup>                  | 2000                                   | V    |      |
|            | MM: machine model <sup>(6)</sup>                      | 120                                    |      |      |
|            | CDM: charged device model <sup>(7)</sup>              | 1500                                   |      |      |
| —          | Latch-up immunity                                     | 200                                    | mA   |      |
| —          | Output short-circuit duration                         | See note <sup>(8)</sup>                |      |      |

- All voltage values, except the differential voltage are with respect to network ground terminal.
- The differential voltage is the non-inverting input terminal with respect to the inverting input terminal. If  $V_{id} > \pm 1$  V, the maximum input current must not exceed  $\pm 1$  mA. In this case ( $V_{id} > \pm 1$  V), an input series resistor must be added to limit the input current.
- Do not exceed 14 V.
- Short-circuits can cause excessive heating. Destructive dissipation can result from simultaneous short-circuits on all amplifiers. These values are typical.
- Human body model: 100 pF discharged through a 1.5 k $\Omega$  resistor between two pins of the device, done for all couples of pin combinations with other pins floating.
- Machine model: a 200 pF capacitor is charged to the specified voltage, then discharged directly between two pins of the device with no external series resistor (internal resistor < 5  $\Omega$ ). This is done for all couples of pin combinations with other pins floating.
- Charged device model: all pins and plus package are charged together to the specified voltage and then discharged directly to ground.
- There is no short-circuit protection inside the device: short-circuits from the output to  $V_{CC}$  can cause excessive heating. The maximum output current is approximately 80 mA, independent of the magnitude of  $V_{CC}$ . Destructive dissipation can result from simultaneous short-circuits on all amplifiers.

**Table 2. Operating conditions**

| Symbol     | Parameter                            | Value                                  | Unit |
|------------|--------------------------------------|----------------------------------------|------|
| $V_{CC}$   | Supply voltage                       | 2.7 to 12                              | V    |
| $V_{icm}$  | Common mode input voltage range      | $(V_{CC-}) - 0.2$ to $(V_{CC+}) + 0.2$ |      |
| $T_{oper}$ | Operating free air temperature range | -40 to 125                             | °C   |

### 3 Electrical characteristics

**Table 3.** Electrical characteristics measured at  $V_{CC} = 3\text{ V}$ ,  $V_{CC-} = 0\text{ V}$ ,  $V_{icm} = V_{CC}/2$ ,  $T_{amb} = 25\text{ }^{\circ}\text{C}$ , and  $R_L$  connected to  $V_{CC}/2$  (unless otherwise specified)

| Symbol                   | Parameter                      | Test conditions                                          | Min. | Typ. | Max. | Unit                           |
|--------------------------|--------------------------------|----------------------------------------------------------|------|------|------|--------------------------------|
| $V_{io}$                 | Input offset voltage           | TS922                                                    |      |      | 3    | mV                             |
|                          |                                | TS922A                                                   |      |      | 0.9  |                                |
|                          |                                | TS922EIJT                                                |      |      | 1.5  |                                |
|                          |                                | $T_{min} \leq T_{amb} \leq T_{max}$ , TS922              |      |      | 5    |                                |
|                          |                                | $T_{min} \leq T_{amb} \leq T_{max}$ , TS922A             |      |      | 1.8  |                                |
|                          |                                | $T_{min} \leq T_{amb} \leq T_{max}$ , TS922EIJT          |      |      | 2.5  |                                |
| $\Delta V_{io}/\Delta T$ | Input offset voltage drift     |                                                          |      | 2    |      | $\mu\text{V}/^{\circ}\text{C}$ |
| $I_{io}$                 | Input offset current           | $V_{out} = V_{CC}/2$                                     |      | 1    | 30   | nA                             |
|                          |                                | $T_{min} \leq T_{amb} \leq T_{max}$                      |      |      | 30   |                                |
| $I_{ib}$                 | Input bias current             | $V_{out} = V_{CC}/2$                                     |      | 15   | 100  | nA                             |
|                          |                                | $T_{min} \leq T_{amb} \leq T_{max}$                      |      |      | 100  |                                |
| $V_{OH}$                 | High level output voltage      | $R_L = 10\text{ k}\Omega$                                | 2.90 |      |      | V                              |
|                          |                                | $T_{min} \leq T_{amb} \leq T_{max}$                      | 2.90 |      |      |                                |
|                          |                                | $R_L = 600\ \Omega$                                      | 2.87 |      |      |                                |
|                          |                                | $T_{min} \leq T_{amb} \leq T_{max}$                      | 2.87 |      |      |                                |
|                          |                                | $R_L = 32\ \Omega$                                       |      | 2.63 |      |                                |
| $V_{OL}$                 | Low level output voltage       | $R_L = 10\text{ k}\Omega$                                |      |      | 50   | mV                             |
|                          |                                | $T_{min} \leq T_{amb} \leq T_{max}$                      |      |      | 50   |                                |
|                          |                                | $R_L = 600\ \Omega$                                      |      |      | 100  |                                |
|                          |                                | $T_{min} \leq T_{amb} \leq T_{max}$                      |      |      | 100  |                                |
|                          |                                | $R_L = 32\ \Omega$                                       |      | 180  |      |                                |
| $A_{vd}$                 | Large signal voltage gain      | $R_L = 10\text{ k}\Omega$ , $V_{out} = 2\text{ V}_{p-p}$ |      | 200  |      | V/mV                           |
|                          |                                | $T_{min} \leq T_{amb} \leq T_{max}$                      | 70   |      |      |                                |
|                          |                                | $R_L = 600\ \Omega$ , $V_{out} = 2\text{ V}_{p-p}$       |      | 35   |      |                                |
|                          |                                | $T_{min} \leq T_{amb} \leq T_{max}$                      | 15   |      |      |                                |
| $I_{CC}$                 | Total supply current           | No load, $V_{out} = V_{CC}/2$                            |      | 2    | 3    | mA                             |
|                          |                                | $T_{min} \leq T_{amb} \leq T_{max}$                      |      |      | 3.2  |                                |
| GBP                      | Gain bandwidth product         | $R_L = 600\ \Omega$                                      |      | 4    |      | MHz                            |
| CMR                      | Common mode rejection ratio    | $V_{icm} = 0\text{ to }3\text{ V}$                       | 60   | 80   |      | dB                             |
|                          |                                | $T_{min} \leq T_{amb} \leq T_{max}$                      | 56   |      |      |                                |
| SVR                      | Supply voltage rejection ratio | $V_{CC} = 2.7\text{ to }3.3\text{ V}$                    | 60   | 85   |      | dB                             |
|                          |                                | $T_{min} \leq T_{amb} \leq T_{max}$                      | 60   |      |      |                                |
| $I_o$                    | Output short-circuit current   |                                                          | 50   | 80   |      | mA                             |

| Symbol   | Parameter                      | Test conditions                                                              | Min. | Typ.  | Max. | Unit                         |
|----------|--------------------------------|------------------------------------------------------------------------------|------|-------|------|------------------------------|
| SR       | Slew rate                      |                                                                              | 0.7  | 1.3   |      | V/ $\mu$ s                   |
| $\phi_m$ | Phase margin at unit gain      | $R_L = 600 \Omega$ , $C_L = 100 \text{ pF}$                                  |      | 68    |      | Degrees                      |
| $G_m$    | Gain margin                    | $R_L = 600 \Omega$ , $C_L = 100 \text{ pF}$                                  |      | 12    |      | dB                           |
| $e_n$    | Equivalent input noise voltage | $f = 1 \text{ kHz}$                                                          |      | 9     |      | $\text{nV}/\sqrt{\text{Hz}}$ |
| THD      | Total harmonic distortion      | $V_{out} = 2 V_{p-p}$ , $f = 1 \text{ kHz}$ , $A_v = 1$ , $R_L = 600 \Omega$ |      | 0.005 |      | %                            |
| $C_s$    | Channel separation             |                                                                              |      | 120   |      | dB                           |

**Table 4.** Electrical characteristics measured at  $V_{CC} = 5 \text{ V}$ ,  $V_{CC-} = 0 \text{ V}$ ,  $V_{icm} = V_{CC}/2$ ,  $T_{amb} = 25 \text{ }^\circ\text{C}$ , and  $R_L$  connected to  $V_{CC}/2$  (unless otherwise specified)

| Symbol                   | Parameter                  | Conditions                                         | Min. | Typ. | Max. | Unit                         |
|--------------------------|----------------------------|----------------------------------------------------|------|------|------|------------------------------|
| $V_{io}$                 | Input offset voltage       | TS922                                              |      |      | 3    | mV                           |
|                          |                            | TS922A                                             |      |      | 0.9  |                              |
|                          |                            | TS922EIJT                                          |      |      | 1.5  |                              |
|                          |                            | $T_{min} \leq T_{amb} \leq T_{max}$ , TS922        |      |      | 5    |                              |
|                          |                            | $T_{min} \leq T_{amb} \leq T_{max}$ , TS922A       |      |      | 1.8  |                              |
|                          |                            | $T_{min} \leq T_{amb} \leq T_{max}$ , TS922EIJT    |      |      | 2.5  |                              |
| $\Delta V_{io}/\Delta T$ | Input offset voltage drift |                                                    |      | 2    |      | $\mu\text{V}/^\circ\text{C}$ |
| $I_{io}$                 | Input offset current       | $V_{out} = V_{CC}/2$                               |      | 1    | 30   | nA                           |
|                          |                            | $T_{min} \leq T_{amb} \leq T_{max}$                |      |      | 30   |                              |
| $I_{ib}$                 | Input bias current         | $V_{out} = V_{CC}/2$                               |      | 15   | 100  | nA                           |
|                          |                            | $T_{min} \leq T_{amb} \leq T_{max}$                |      |      | 100  |                              |
| $V_{OH}$                 | High level output voltage  | $R_L = 10 \text{ k}\Omega$                         | 4.9  |      |      | V                            |
|                          |                            | $T_{min} \leq T_{amb} \leq T_{max}$                | 4.9  |      |      |                              |
|                          |                            | $R_L = 600 \Omega$                                 | 4.85 |      |      |                              |
|                          |                            | $T_{min} \leq T_{amb} \leq T_{max}$                | 4.85 |      |      |                              |
| $V_{OL}$                 | Low level output voltage   | $R_L = 10 \text{ k}\Omega$                         |      |      | 50   | mV                           |
|                          |                            | $T_{min} \leq T_{amb} \leq T_{max}$                |      |      | 50   |                              |
|                          |                            | $R_L = 600 \Omega$                                 |      |      | 120  |                              |
|                          |                            | $T_{min} \leq T_{amb} \leq T_{max}$                |      |      | 120  |                              |
|                          |                            | $R_L = 32 \Omega$                                  |      | 300  |      |                              |
| $A_{vd}$                 | Large signal voltage gain  | $R_L = 10 \text{ k}\Omega$ , $V_{out} = 2 V_{p-p}$ |      | 200  |      | V/mV                         |
|                          |                            | $T_{min} \leq T_{amb} \leq T_{max}$                | 70   |      |      |                              |
|                          |                            | $R_L = 600 \Omega$ , $V_{out} = 2 V_{p-p}$         |      | 35   |      |                              |
|                          |                            | $T_{min} \leq T_{amb} \leq T_{max}$                | 20   |      |      |                              |
| $I_{CC}$                 | Total supply current       | No load, $V_{out} = V_{CC}/2$                      |      | 2    | 3    | mA                           |
|                          |                            | $T_{min} \leq T_{amb} \leq T_{max}$                |      |      | 3.2  |                              |

| Symbol   | Parameter                      | Conditions                                                          | Min. | Typ.  | Max. | Unit                   |
|----------|--------------------------------|---------------------------------------------------------------------|------|-------|------|------------------------|
| GBP      | Gain bandwidth product         | $R_L = 600 \Omega$                                                  |      | 4     |      | MHz                    |
| CMR      | Common mode rejection ratio    | $V_{icm} = 0 \text{ to } 5 \text{ V}$                               | 60   | 80    |      | dB                     |
|          |                                | $T_{min} \leq T_{amb} \leq T_{max}$                                 | 56   |       |      |                        |
| SVR      | Supply voltage rejection ratio | $V_{CC} = 4.5 \text{ to } 5.5 \text{ V}$                            | 60   | 85    |      |                        |
|          |                                | $T_{min} \leq T_{amb} \leq T_{max}$                                 | 60   |       |      |                        |
| $I_o$    | Output short-circuit current   |                                                                     | 50   | 80    |      | mA                     |
| SR       | Slew rate                      |                                                                     | 0.7  | 1.3   |      | V/ $\mu$ s             |
| $\phi_m$ | Phase margin at unit gain      | $R_L = 600 \Omega, C_L = 100 \text{ pF}$                            |      | 68    |      | Degrees                |
| $G_m$    | Gain margin                    |                                                                     |      | 12    |      | dB                     |
| $e_n$    | Equivalent input noise voltage | $f = 1 \text{ kHz}$                                                 |      | 9     |      | nV/ $\sqrt{\text{Hz}}$ |
| THD      | Total harmonic distortion      | $V_{out} = 2 V_{p-p}, f = 1 \text{ kHz}, A_v = 1, R_L = 600 \Omega$ |      | 0.005 |      | %                      |
| $C_s$    | Channel separation             |                                                                     |      | 120   |      | dB                     |

## 4 Electrical characteristic curves

Figure 3. Output short-circuit current vs. output voltage



Figure 4. Total supply current vs. supply voltage

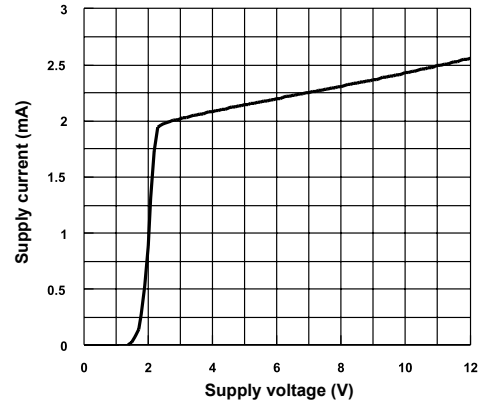

Figure 5. Voltage gain and phase vs. frequency

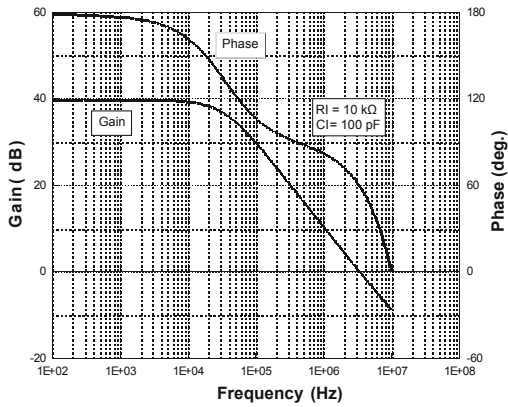

Figure 6. Equivalent input noise voltage vs. frequency



Figure 7. THD + noise vs. frequency ( $R_L = 2 \text{ k}\Omega$ ,  $V_O = 10 \text{ Vpp}$ ,  $V_{CC} = \pm 6 \text{ V}$ )



Figure 8. THD + noise vs. frequency ( $R_L = 32 \Omega$ ,  $V_O = 4 \text{ Vpp}$ ,  $V_{CC} = \pm 2.5 \text{ V}$ )



Figure 9. THD + noise vs. frequency ( $R_L = 32 \Omega$ ,  $V_o = 2$  Vpp,  $V_{CC} = \pm 1.5$  V)



Figure 10. THD + noise vs. output voltage ( $R_L = 600 \Omega$ ,  $f = 1$  kHz,  $V_{CC} = 0/3$  V)



Figure 11. THD + noise vs. output voltage ( $R_L = 32 \Omega$ ,  $f = 1$  kHz,  $V_{CC} = \pm 1.5$  V)

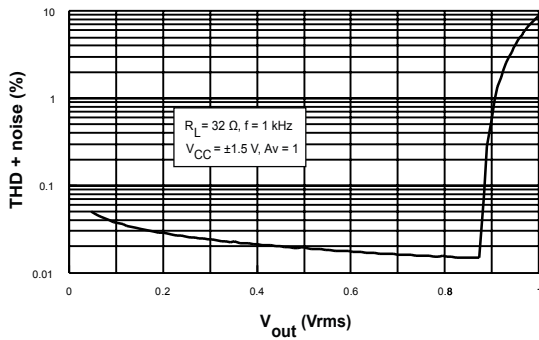

Figure 12. THD + noise vs. output voltage ( $R_L = 2$  k $\Omega$ ,  $f = 1$  kHz,  $V_{CC} = \pm 1.5$  V)



Figure 13. Open loop gain and phase vs. frequency





## 5 Package information

In order to meet environmental requirements, ST offers these devices in different grades of ECOPACK® packages, depending on their level of environmental compliance. ECOPACK® specifications, grade definitions and product status are available at: [www.st.com](http://www.st.com). ECOPACK® is an ST trademark.

### 5.1 8-bump Flip-chip package information

Figure 14. 8-bump Flip-chip package dimensions (top view)

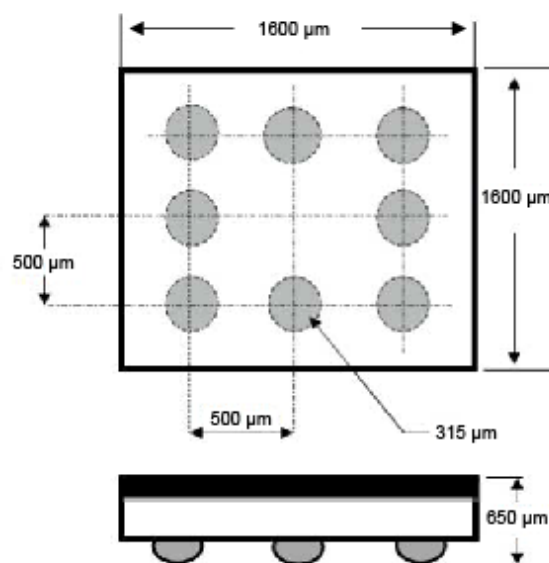

1. Die size: 1600 μm x 1600 μm ±30 μm, Die height: 350 μm ±20 μm, die height (including bumps): 650 μm, bump diameter: 315 μm ±50 μm, bump height: 250 μm ±40 μm, pitch: 500 μm ±10 μm, backcoating.

Figure 15. 8-bump Flip-chip recommended footprint (TS922EIJT)

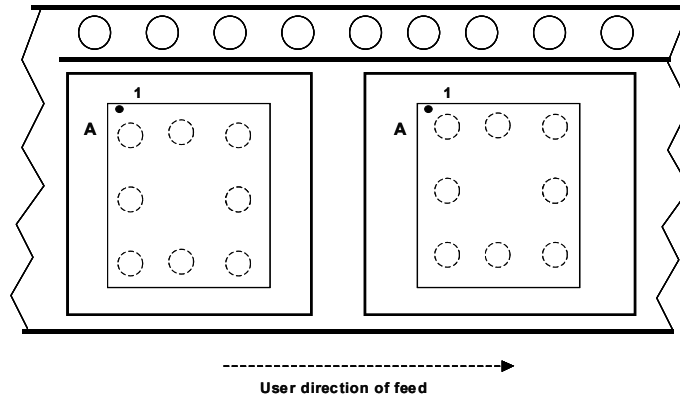

Figure 16. 8-bump Flip-chip marking (top view)



1. ST logo
2. Part number
3. Date code: Y = year, WW = week
4. This dot indicates the bump corner 1A

Figure 17. 8-bump Flip-chip tape and reel specification (top view)



1. Device orientation: the devices are oriented in the carrier pocket with bump number A1 adjacent to the pocket holes.

## 5.2 SO8 package information

Figure 18. SO8 package outline

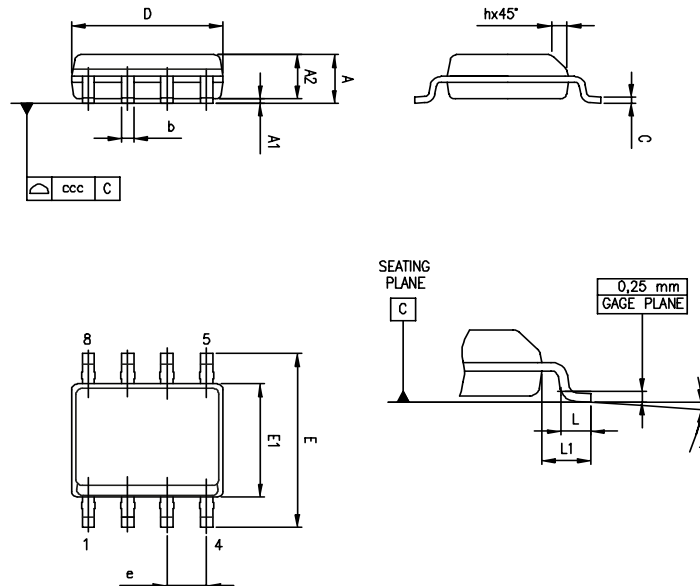

Table 5. SO8 package mechanical data

| Ref. | Dimensions  |      |      |        |       |       |
|------|-------------|------|------|--------|-------|-------|
|      | Millimeters |      |      | Inches |       |       |
|      | Min.        | Typ. | Max. | Min.   | Typ.  | Max.  |
| A    |             |      | 1.75 |        |       | 0.069 |
| A1   | 0.10        |      | 0.25 | 0.004  |       | 0.010 |
| A2   | 1.25        |      |      | 0.049  |       |       |
| b    | 0.28        |      | 0.48 | 0.011  |       | 0.019 |
| c    | 0.17        |      | 0.23 | 0.007  |       | 0.010 |
| D    | 4.80        | 4.90 | 5.00 | 0.189  | 0.193 | 0.197 |
| E    | 5.80        | 6.00 | 6.20 | 0.228  | 0.236 | 0.244 |
| E1   | 3.80        | 3.90 | 4.00 | 0.150  | 0.154 | 0.157 |
| e    |             | 1.27 |      |        | 0.050 |       |
| h    | 0.25        |      | 0.50 | 0.010  |       | 0.020 |
| L    | 0.40        |      | 1.27 | 0.016  |       | 0.050 |
| L1   |             | 1.04 |      |        | 0.040 |       |
| k    | 0°          |      | 8°   | 0°     |       | 8°    |
| ccc  |             |      | 0.10 |        |       | 0.004 |

### 5.3 TSSOP8 package information

Figure 19. TSSOP8 package outline

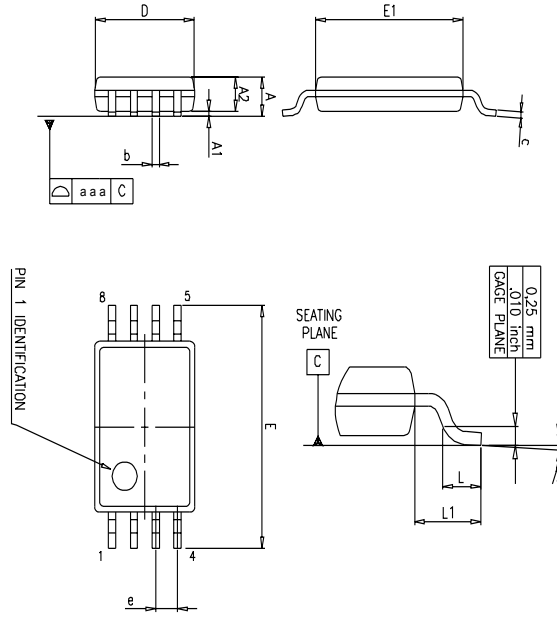

Table 6. TSSOP8 mechanical data

| Ref. | Dimensions  |      |      |        |        |       |
|------|-------------|------|------|--------|--------|-------|
|      | Millimeters |      |      | Inches |        |       |
|      | Min.        | Typ. | Max. | Min.   | Typ.   | Max.  |
| A    |             |      | 1.2  |        |        | 0.047 |
| A1   | 0.05        |      | 0.15 | 0.002  |        | 0.006 |
| A2   | 0.80        | 1.00 | 1.05 | 0.031  | 0.039  | 0.041 |
| b    | 0.19        |      | 0.30 | 0.007  |        | 0.012 |
| c    | 0.09        |      | 0.20 | 0.004  |        | 0.008 |
| D    | 2.90        | 3.00 | 3.10 | 0.114  | 0.118  | 0.122 |
| E    | 6.20        | 6.40 | 6.60 | 0.244  | 0.252  | 0.260 |
| E1   | 4.30        | 4.40 | 4.50 | 0.169  | 0.173  | 0.177 |
| e    |             | 0.65 |      |        | 0.0256 |       |
| k    | 0°          |      | 8°   | 0°     |        | 8°    |
| L    | 0.45        | 0.60 | 0.75 | 0.018  | 0.024  | 0.030 |
| L1   |             | 1    |      |        | 0.039  |       |
| aaa  |             | 0.1  |      |        | 0.004  |       |

## 6 Ordering information

**Table 7. Ordering information**

| Order code                | Temperature range | Package                    | Packing               | Marking |
|---------------------------|-------------------|----------------------------|-----------------------|---------|
| TS922ID                   | -40 °C to 125 °C  | SO8                        | Tube or tape and reel | 922I    |
| TS922IDT                  |                   |                            |                       | 922AI   |
| TS922AID                  |                   |                            |                       | 922IY   |
| TS922AIDT                 |                   | SO8 (automotive grade)     | Tape and reel         | 922AIY  |
| TS922IYDT <sup>(1)</sup>  |                   |                            |                       | 922I    |
| TS922AIYDT <sup>(1)</sup> |                   | TSSOP8                     | Tape and reel         | 922AI   |
| TS922IPT                  |                   |                            |                       | 922IY   |
| TS922AIPT                 |                   | TSSOP8 (automotive grade)  | Tape and reel         | 922AY   |
| TS922IYPT <sup>(1)</sup>  |                   |                            |                       | 922     |
| TS922AIYPT <sup>(1)</sup> |                   | Flip-chip with backcoating | Tape and reel         | 922AY   |
| TS922EIJT                 |                   |                            |                       | 922     |

1. Qualified and characterized according to AEC Q100 and Q003 or equivalent, advanced screening according to AEC Q001 and Q 002 or equivalent.

## Revision history

**Table 8. Document revision history**

| Date        | Revision | Changes                                                                                                                                                                                                                                                                                                                                                                                                                                                                                                                    |
|-------------|----------|----------------------------------------------------------------------------------------------------------------------------------------------------------------------------------------------------------------------------------------------------------------------------------------------------------------------------------------------------------------------------------------------------------------------------------------------------------------------------------------------------------------------------|
| 01-Feb-2001 | 1        | First release.                                                                                                                                                                                                                                                                                                                                                                                                                                                                                                             |
| 01-Jul-2004 | 2        | Flip-chip package inserted in the document.                                                                                                                                                                                                                                                                                                                                                                                                                                                                                |
| 02-May-2005 | 3        | Modifications in AMR Table 1 (explanation of $V_{id}$ and $V_i$ limits, ESD MM and CDM values added, $R_{thja}$ added).                                                                                                                                                                                                                                                                                                                                                                                                    |
| 01-Aug-2005 | 4        | PPAP references inserted in the datasheet, see Table 8.                                                                                                                                                                                                                                                                                                                                                                                                                                                                    |
| 01-Mar-2006 | 5        | TS922EIJT part number inserted in the datasheet, see Table 8.                                                                                                                                                                                                                                                                                                                                                                                                                                                              |
| 26-Jan-2007 | 6        | Modifications in AMR Table 1 ( $R_{thjc}$ added), parameter limits on full temperature range added in Table 3 and Table 4.                                                                                                                                                                                                                                                                                                                                                                                                 |
| 12-Nov-2007 | 7        | Added notes on ESD in AMR table.<br>Re-formatted package information.<br>Added notes for automotive grade in order codes table.                                                                                                                                                                                                                                                                                                                                                                                            |
| 02-Feb-2010 | 8        | Document reformatted.<br>Added root part number TS922A on cover page.<br>Removed TS922AIYD order code from Table 8.                                                                                                                                                                                                                                                                                                                                                                                                        |
| 15-Jan-2013 | 9        | Added MiniSO8 package.<br>Modified test conditions for CMR in Table 3 and Table 4.<br>Replaced $V_{DD}$ by $V_{CC}$ in title of Table 3, Table 4, and Table 5.<br>Updated titles of Figure 7 to Figure 12 (added conditions to differentiate them).<br>Removed TS922IYD device from Table 8.<br>Minor corrections throughout document.                                                                                                                                                                                     |
| 04-Jun-2013 | 10       | Features: updated package information for Flip-chip<br>Figure 2: Updated title<br>Table 1: updated footnotes 5, 6, and 7<br>Table 3 and Table 4: replaced $DV_{io}$ with $\Delta V_{io}/\Delta T$<br>Figure 14: added backcoating to package information<br>Figure 16: updated footnote 3<br>Table 8: updated package information for Flip-chip                                                                                                                                                                            |
| 27-Jun-2013 | 11       | Figure 14: updated to include new height for backcoating                                                                                                                                                                                                                                                                                                                                                                                                                                                                   |
| 20-Jan-2016 | 12       | Updated document layout<br>Removed MiniSO8 and DIP8 packages<br>Updated cover image: removed J, D (plastic micropackage), and P (thin shrink small outline package) respectively from Flip-chip with backcoating, SO8, and TSSOP packages.<br>Table 6: updated SO8 information for min "k" parameter (mm dimensions)<br>Table 7: updated "aaa" information. These are "typ" not "max" values.<br>Table 8: "Order codes": removed following order codes: TS922IST, TS922AIST, TS922IN, TS922IYST, TS922AIYST, and TS922IJT. |

| Date        | Revision | Changes                                                                                                                                                                                                                                             |
|-------------|----------|-----------------------------------------------------------------------------------------------------------------------------------------------------------------------------------------------------------------------------------------------------|
| 20-Jul-2018 | 13       | Updated features and applications in cover page.<br>Updated <a href="#">Figure 1. Pinout for Flip-chip package (top view)</a> .<br>Updated <a href="#">Section 6 Ordering information</a> .<br>Removed "Macromodel" section.<br>Minor text changes. |



## Contents

|            |                                                                |           |
|------------|----------------------------------------------------------------|-----------|
| <b>1</b>   | <b>Pin diagrams</b> .....                                      | <b>2</b>  |
| <b>2</b>   | <b>Absolute maximum ratings and operating conditions</b> ..... | <b>3</b>  |
| <b>3</b>   | <b>Electrical characteristics</b> .....                        | <b>4</b>  |
| <b>4</b>   | <b>Electrical characteristic curves</b> .....                  | <b>7</b>  |
| <b>5</b>   | <b>Package information</b> .....                               | <b>9</b>  |
| <b>5.1</b> | 8-bump Flip-chip package information .....                     | 9         |
| <b>5.2</b> | SO8 package information .....                                  | 12        |
| <b>5.3</b> | TSSOP8 package information .....                               | 13        |
| <b>6</b>   | <b>Ordering information</b> .....                              | <b>14</b> |
|            | <b>Revision history</b> .....                                  | <b>15</b> |

**IMPORTANT NOTICE – PLEASE READ CAREFULLY**

STMicroelectronics NV and its subsidiaries (“ST”) reserve the right to make changes, corrections, enhancements, modifications, and improvements to ST products and/or to this document at any time without notice. Purchasers should obtain the latest relevant information on ST products before placing orders. ST products are sold pursuant to ST’s terms and conditions of sale in place at the time of order acknowledgement.

Purchasers are solely responsible for the choice, selection, and use of ST products and ST assumes no liability for application assistance or the design of Purchasers’ products.

No license, express or implied, to any intellectual property right is granted by ST herein.

Resale of ST products with provisions different from the information set forth herein shall void any warranty granted by ST for such product.

ST and the ST logo are trademarks of ST. All other product or service names are the property of their respective owners.

Information in this document supersedes and replaces information previously supplied in any prior versions of this document.

© 2018 STMicroelectronics – All rights reserved

## Данный компонент на территории Российской Федерации

### Вы можете приобрести в компании MosChip.

Для оперативного оформления запроса Вам необходимо перейти по данной ссылке:

<http://moschip.ru/get-element>

Вы можете разместить у нас заказ для любого Вашего проекта, будь то серийное производство или разработка единичного прибора.

В нашем ассортименте представлены ведущие мировые производители активных и пассивных электронных компонентов.

Нашей специализацией является поставка электронной компонентной базы двойного назначения, продукции таких производителей как XILINX, Intel (ex.ALTERA), Vicor, Microchip, Texas Instruments, Analog Devices, Mini-Circuits, Amphenol, Glenair.

Сотрудничество с глобальными дистрибьюторами электронных компонентов, предоставляет возможность заказывать и получать с международных складов практически любой перечень компонентов в оптимальные для Вас сроки.

На всех этапах разработки и производства наши партнеры могут получить квалифицированную поддержку опытных инженеров.

Система менеджмента качества компании отвечает требованиям в соответствии с ГОСТ Р ИСО 9001, ГОСТ РВ 0015-002 и ЭС РД 009

### Офис по работе с юридическими лицами:

105318, г.Москва, ул.Щербаковская д.3, офис 1107, 1118, ДЦ «Щербаковский»

Телефон: +7 495 668-12-70 (многоканальный)

Факс: +7 495 668-12-70 (доб.304)

E-mail: [info@moschip.ru](mailto:info@moschip.ru)

Skype отдела продаж:

moschip.ru

moschip.ru\_4

moschip.ru\_6

moschip.ru\_9