

### FEATURES

- 44 V supply maximum ratings
- V<sub>SS</sub> to V<sub>DD</sub> analog signal range
- Low on resistance (100 Ω maximum)
- Low power (I<sub>SUPPLY</sub> < 75 μA)
- Fast switching
- Break-before-make switching action
- Plug-in replacement for DG408/DG409

### APPLICATIONS

- Audio and video routing
- Automatic test equipment
- Data acquisition systems
- Battery-powered systems
- Sample-and-hold systems
- Communication systems

### GENERAL DESCRIPTION

The ADG408/ADG409 are monolithic CMOS analog multiplexers comprising eight single channels and four differential channels, respectively. The ADG408 switches one of eight inputs to a common output as determined by the 3-bit binary address lines A0, A1, and A2. The ADG409 switches one of four differential inputs to a common differential output, as determined by the 2-bit binary address lines A0 and A1. An EN input on both devices is used to enable or disable the device. When the device is disabled, all channels are switched off.

The ADG408/ADG409 are designed on an enhanced LC<sup>2</sup>MOS process that provides low power dissipation yet gives high switching speed and low on resistance. Each channel conducts equally well in both directions when on and has an input signal range that extends to the supplies. In the off condition, signal levels up to the supplies are blocked. All channels exhibit break-before-make switching action, preventing momentary shorting when switching channels. Inherent in the design is low charge injection for minimum transients when switching the digital inputs.

The ADG408/ADG409 are improved replacements for the DG408/DG409 analog multiplexers.

### FUNCTIONAL BLOCK DIAGRAMS

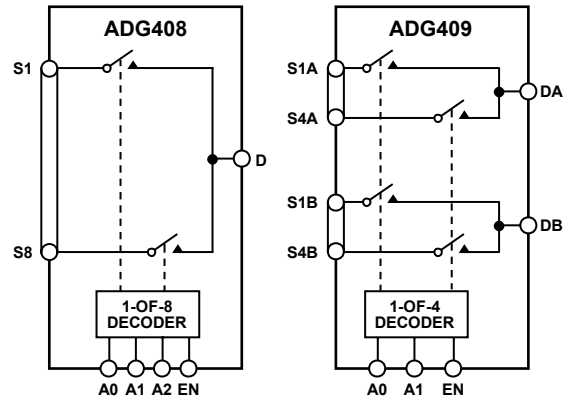

Figure 1.

### PRODUCT HIGHLIGHTS

1. Extended Signal Range. The ADG408/ADG409 are fabricated on an enhanced LC<sup>2</sup>MOS process, giving an increased signal range that extends to the supply rails.
2. Low Power Dissipation.
3. Low R<sub>ON</sub>.
4. Single-Supply Operation. For applications where the analog signal is unipolar, the ADG408/ADG409 can be operated from a single rail power supply. The parts are fully specified with a single 12 V power supply and remain functional with single supplies as low as 5 V.

#### Rev. C

Information furnished by Analog Devices is believed to be accurate and reliable. However, no responsibility is assumed by Analog Devices for its use, nor for any infringements of patents or other rights of third parties that may result from its use. Specifications subject to change without notice. No license is granted by implication or otherwise under any patent or patent rights of Analog Devices. Trademarks and registered trademarks are the property of their respective owners.

**TABLE OF CONTENTS**

Features .....	1	Absolute Maximum Ratings .....	6
Applications.....	1	ESD Caution.....	6
Functional Block Diagrams.....	1	Pin Configurations and Function Descriptions .....	7
General Description .....	1	Typical Performance Characteristics .....	8
Product Highlights .....	1	Test Circuits.....	11
Revision History .....	2	Terminology .....	13
Specifications.....	3	Outline Dimensions .....	14
Dual Supply .....	3	Ordering Guide .....	16
Single Supply .....	4		

**REVISION HISTORY**

**10/06—Rev. B to Rev. C**

Updated Format.....	Universal
Changes to Table 3.....	6
Inserted Table 4 and Table 5.....	7
Updated Outline Dimensions .....	14
Changes to Ordering Guide .....	15

**3/03—Rev. A to Rev. B**

Changes to Ordering Guide .....	4
Updated Outline Dimensions .....	11

**2/01—Revision 0: Initial Version**

# SPECIFICATIONS

## DUAL SUPPLY

$V_{DD} = 15\text{ V}$ ,  $V_{SS} = -15\text{ V}$ ,  $GND = 0\text{ V}$ , unless otherwise noted.

Table 1.

Parameter	B Version		T Version		Unit	Test Conditions/Comments
	+25°C	-40°C to +85°C	+25°C	-55°C to +125°C		
<b>ANALOG SWITCH</b>						
Analog Signal Range		$V_{SS}$ to $V_{DD}$		$V_{SS}$ to $V_{DD}$	V	
$R_{ON}$	40		40		$\Omega$ typ	$V_D = \pm 10\text{ V}$ , $I_S = -10\text{ mA}$
	100	125	100	125	$\Omega$ max	
$\Delta R_{ON}$	15		15		$\Omega$ max	$V_D = +10\text{ V}$ , $-10\text{ V}$
<b>LEAKAGE CURRENTS</b>						
Source Off Leakage $I_S$ (OFF)	$\pm 0.5$	$\pm 50$	$\pm 0.5$	$\pm 50$	nA max	$V_D = \pm 10\text{ V}$ , $V_S = \mp 10\text{ V}$ ; see Figure 19
Drain Off Leakage $I_D$ (OFF)						$V_D = \pm 10\text{ V}$ ; $V_S = \mp 10\text{ V}$ ; see Figure 20
ADG408	$\pm 1$	$\pm 100$	$\pm 1$	$\pm 100$	nA max	
ADG409	$\pm 1$	$\pm 50$	$\pm 1$	$\pm 50$	nA max	
Channel On Leakage $I_D$ , $I_S$ (ON)						$V_S = V_D = \pm 10\text{ V}$ ; see Figure 21
ADG408	$\pm 1$	$\pm 100$	$\pm 1$	$\pm 100$	nA max	
ADG409	$\pm 1$	$\pm 50$	$\pm 1$	$\pm 50$	nA max	
<b>DIGITAL INPUTS</b>						
Input High Voltage, $V_{INH}$		2.4		2.4	V min	
Input Low Voltage, $V_{INL}$		0.8		0.8	V max	
Input Current						
$I_{INL}$ or $I_{INH}$		$\pm 10$		$\pm 10$	$\mu\text{A}$ max	$V_{IN} = 0$ or $V_{DD}$
$C_{IN}$ , Digital Input Capacitance	8		8		pF typ	$f = 1\text{ MHz}$
<b>DYNAMIC CHARACTERISTICS<sup>1</sup></b>						
$t_{TRANSITION}$		120		120	ns typ	$R_L = 300\ \Omega$ , $C_L = 35\text{ pF}$ ;
		250		250	ns max	$V_{S1} = \pm 10\text{ V}$ , $V_{S8} = \mp 10\text{ V}$ ; see Figure 22
$t_{OPEN}$	10	10	10	10	ns min	$R_L = 300\ \Omega$ , $C_L = 35\text{ pF}$ ;
						$V_S = 5\text{ V}$ ; see Figure 23
$t_{ON}$ (EN)	85	125	85	125	ns typ	$R_L = 300\ \Omega$ , $C_L = 35\text{ pF}$ ;
	150	225	150	225	ns max	$V_S = 5\text{ V}$ ; see Figure 24
$t_{OFF}$ (EN)		65		65	ns typ	$R_L = 300\ \Omega$ , $C_L = 35\text{ pF}$ ;
		150		150	ns max	$V_S = 5\text{ V}$ ; see Figure 24
Charge Injection	20		20		pC typ	$V_S = 0\text{ V}$ , $R_S = 0\ \Omega$ , $C_L = 10\text{ nF}$ ; see Figure 25
OFF Isolation	-75		-75		dB typ	$R_L = 1\text{ k}\Omega$ , $f = 100\text{ kHz}$ ;
						$V_{EN} = 0\text{ V}$ ; see Figure 26
Channel-to-Channel Crosstalk	85		85		dB typ	$R_L = 1\text{ k}\Omega$ , $f = 100\text{ kHz}$ ; see Figure 27
$C_S$ (OFF)	11		11		pF typ	$f = 1\text{ MHz}$
$C_D$ (OFF)						$f = 1\text{ MHz}$
ADG408	40		40		pF typ	
ADG409	20		20		pF typ	
$C_D$ , $C_S$ (ON)						$f = 1\text{ MHz}$
ADG408	54		54		pF typ	
ADG409	34		34		pF typ	

# ADG408/ADG409

Parameter	B Version		T Version		Unit	Test Conditions/Comments
	+25°C	-40°C to +85°C	+25°C	-55°C to +125°C		
<b>POWER REQUIREMENTS</b>						
$I_{DD}$		1		1	$\mu\text{A typ}$	$V_{IN} = 0\text{ V}, V_{EN} = 0\text{ V}$
		5		5	$\mu\text{A max}$	
$I_{SS}$		1		1	$\mu\text{A typ}$	
		5		5	$\mu\text{A max}$	
$I_{DD}$	100		100		$\mu\text{A typ}$	$V_{IN} = 0\text{ V}, V_{EN} = 2.4\text{ V}$
	200	500	200	500	$\mu\text{A max}$	

<sup>1</sup> Guaranteed by design, not subject to production test.

## SINGLE SUPPLY

$V_{DD} = 12\text{ V}, V_{SS} = 0\text{ V}, \text{GND} = 0\text{ V}$ , unless otherwise noted.

**Table 2.**

Parameter	B Version		T Version		Unit	Test Conditions/Comments
	+25°C	-40°C to +85°C	+25°C	-55°C to +125°C		
<b>ANALOG SWITCH</b>						
Analog Signal Range		0 to $V_{DD}$		0 to $V_{DD}$	V	
$R_{ON}$	90		90		$\Omega\text{ typ}$	$V_D = 3\text{ V}, 10\text{ V}, I_S = -1\text{ mA}$
<b>LEAKAGE CURRENTS</b>						
Source Off Leakage $I_S$ (OFF)	$\pm 0.5$	$\pm 50$	$\pm 0.5$	$\pm 50$	nA max	$V_D = 8\text{ V}/0\text{ V}, V_S = 0\text{ V}/8\text{ V}$ ; see Figure 19
Drain Off Leakage $I_D$ (OFF)						$V_D = 8\text{ V}/0\text{ V}, V_S = 0\text{ V}/8\text{ V}$ ; see Figure 20
ADG408	$\pm 1$	$\pm 100$	$\pm 1$	$\pm 100$	nA max	
ADG409	$\pm 1$	$\pm 50$	$\pm 1$	$\pm 50$	nA max	
Channel On Leakage $I_D, I_S$ (ON)						$V_S = V_D = 8\text{ V}/0\text{ V}$ ; see Figure 21
ADG408	$\pm 1$	$\pm 100$	$\pm 1$	$\pm 100$	nA max	
ADG409	$\pm 1$	$\pm 50$	$\pm 1$	$\pm 50$	nA max	
<b>DIGITAL INPUTS</b>						
Input High Voltage, $V_{INH}$		2.4		2.4	V min	
Input Low Voltage, $V_{INL}$		0.8		0.8	V max	
Input Current						
$I_{INL}$ or $I_{INH}$		$\pm 10$		$\pm 10$	$\mu\text{A max}$	$V_{IN} = 0$ or $V_{DD}$
$C_{IN}$ , Digital Input Capacitance	8		8		pF typ	$f = 1\text{ MHz}$
<b>DYNAMIC CHARACTERISTICS<sup>1</sup></b>						
$t_{TRANSITION}$	130		130		ns typ	$R_L = 300\ \Omega, C_L = 35\text{ pF}$ ; $V_{S1} = 8\text{ V}/0\text{ V}, V_{S8} = 0\text{ V}/8\text{ V}$ ; see Figure 22
$t_{OPEN}$	10		10		ns typ	$R_L = 300\ \Omega, C_L = 35\text{ pF}$ ;
$t_{ON}$ (EN)	140		140		ns typ	$V_S = 5\text{ V}$ ; see Figure 23 $R_L = 300\ \Omega, C_L = 35\text{ pF}$ ;
$t_{OFF}$ (EN)	60		60		ns typ	$V_S = 5\text{ V}$ ; see Figure 24 $R_L = 300\ \Omega, C_L = 35\text{ pF}$ ;
Charge Injection	5		5		pC typ	$V_S = 0\text{ V}, R_S = 0\ \Omega, C_L = 10\text{ nF}$ ; see Figure 25
Off Isolation	-75		-75		dB typ	$R_L = 1\text{ k}\Omega, f = 100\text{ kHz}$ ; $V_{EN} = 0\text{ V}$ ; see Figure 26

Parameter	B Version		T Version		Unit	Test Conditions/Comments
	+25°C	-40°C to +85°C	+25°C	-55°C to +125°C		
Channel-to-Channel Crosstalk	85		85		dB typ	$R_L = 1\text{ k}\Omega$ , $f = 100\text{ kHz}$ ; see Figure 27
$C_S$ (OFF)	11		11		pF typ	$f = 1\text{ MHz}$
$C_D$ (OFF)						$f = 1\text{ MHz}$
ADG408	40		40		pF typ	
ADG409	20		20		pF typ	
$C_D$ , $C_S$ (ON)						$f = 1\text{ MHz}$
ADG408	54		54		pF typ	
ADG409	34		34		pF typ	
<b>POWER REQUIREMENTS</b>						
$I_{DD}$		1		1	$\mu\text{A typ}$	$V_{IN} = 0\text{ V}$ , $V_{EN} = 0\text{ V}$
		5		5	$\mu\text{A max}$	
$I_{DD}$	100		100		$\mu\text{A typ}$	$V_{IN} = 0\text{ V}$ , $V_{EN} = 2.4\text{ V}$
	200	500	200	500	$\mu\text{A max}$	

<sup>1</sup> Guaranteed by design, not subject to production test.

## ABSOLUTE MAXIMUM RATINGS

T<sub>A</sub> = 25°C, unless otherwise noted.

**Table 3.**

Parameter	Rating
V <sub>DD</sub> to V <sub>SS</sub>	44 V
V <sub>DD</sub> to GND	−0.3 V to +32 V
V <sub>SS</sub> to GND	+0.3 V to −32 V
Analog, Digital Inputs	V <sub>SS</sub> − 2 V to V <sub>DD</sub> + 2 V or 20 mA, whichever occurs first
Continuous Current, S or D	20 mA
Peak Current, S or D (Pulsed at 1 ms, 10% Duty Cycle Maximum)	40 mA
Operating Temperature Range	
Industrial (B Version)	−40° C to +85° C
Extended (T Version)	−55° C to +125° C
Storage Temperature Range	−65° C to +150° C
Junction Temperature	150° C
CERDIP Package, Power Dissipation	900 mW
θ <sub>JA</sub> , Thermal Impedance	76° C/W
Lead Temperature, Soldering (10 sec)	300° C
PDIP Package, Power Dissipation	470 mW
θ <sub>JA</sub> , Thermal Impedance	117° C/W
Lead Temperature, Soldering (10 sec)	260° C
TSSOP Package, Power Dissipation	450 mW
θ <sub>JA</sub> , Thermal Impedance	155° C/W
θ <sub>JC</sub> , Thermal Impedance	50° C/W
SOIC Package, Power Dissipation	600 mW
θ <sub>JA</sub> , Thermal Impedance	77° C/W
Lead Temperature, Soldering	
Vapor Phase (60 sec)	215° C
Infrared (15 sec)	220° C

Stresses above those listed under Absolute Maximum Ratings may cause permanent damage to the device. This is a stress rating only; functional operation of the device at these or any other conditions above those indicated in the operational section of this specification is not implied. Exposure to absolute maximum rating conditions for extended periods may affect device reliability.

### ESD CAUTION



**ESD (electrostatic discharge) sensitive device.** Charged devices and circuit boards can discharge without detection. Although this product features patented or proprietary protection circuitry, damage may occur on devices subjected to high energy ESD. Therefore, proper ESD precautions should be taken to avoid performance degradation or loss of functionality.

# PIN CONFIGURATIONS AND FUNCTION DESCRIPTIONS



Figure 2. ADG408 Pin Configuration



Figure 3. ADG409 Pin Configuration

Table 4. ADG408 Pin Function Descriptions

Pin No.	Mnemonic	Description
1	A0	Logic Control Input.
2	EN	Active High Digital Input. When low, the device is disabled and all switches are off. When high, Ax logic inputs determine on switches.
3	V <sub>SS</sub>	Most Negative Power Supply Potential in Dual Supplies. In single-supply applications, it can be connected to ground.
4	S1	Source Terminal 1. Can be an input or an output.
5	S2	Source Terminal 2. Can be an input or an output.
6	S3	Source Terminal 3. Can be an input or an output.
7	S4	Source Terminal 4. Can be an input or an output.
8	D	Drain Terminal. Can be an input or an output.
9	S8	Source Terminal 8. Can be an input or an output.
10	S7	Source Terminal 7. Can be an input or an output.
11	S6	Source Terminal 6. Can be an input or an output.
12	S5	Source Terminal 5. Can be an input or an output.
13	V <sub>DD</sub>	Most Positive Power Supply Potential.
14	GND	Ground (0 V) Reference.
15	A2	Logic Control Input.
16	A1	Logic Control Input.

Table 5. ADG409 Pin Function Descriptions

Pin No.	Mnemonic	Description
1	A0	Logic Control Input.
2	EN	Active High Digital Input. When low, the device is disabled and all switches are off. When high, Ax logic inputs determine on switches.
3	V <sub>SS</sub>	Most Negative Power Supply Potential in Dual Supplies. In single-supply applications, it can be connected to ground.
4	S1A	Source Terminal 1A. Can be an input or an output.
5	S2A	Source Terminal 2A. Can be an input or an output.
6	S3A	Source Terminal 3A. Can be an input or an output.
7	S4A	Source Terminal 4A. Can be an input or an output.
8	DA	Drain Terminal A. Can be an input or an output.
9	DB	Drain Terminal B. Can be an input or an output.
10	S4B	Source Terminal 4B. Can be an input or an output.
11	S3B	Source Terminal 3B. Can be an input or an output.
12	S2B	Source Terminal 2B. Can be an input or an output.
13	S1B	Source Terminal 1B. Can be an input or an output.
14	V <sub>DD</sub>	Most Positive Power Supply Potential.
15	GND	Ground (0 V) Reference.
16	A1	Logic Control Input.

Table 6. ADG408 Truth Table

A2	A1	A0	EN	ON SWITCH
X	X	X	0	NONE
0	0	0	1	1
0	0	1	1	2
0	1	0	1	3
0	1	1	1	4
1	0	0	1	5
1	0	1	1	6
1	1	0	1	7
1	1	1	1	8

Table 7. ADG409 Truth Table

A1	A0	EN	ON SWITCH PAIR
X	X	0	NONE
0	0	1	1
0	1	1	2
1	0	1	3
1	1	1	4

## TYPICAL PERFORMANCE CHARACTERISTICS

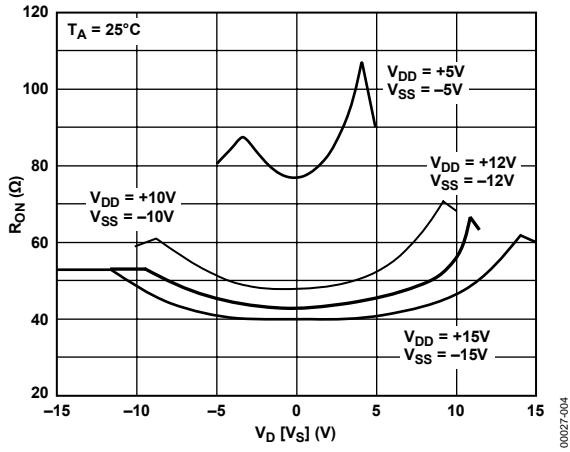

Figure 4.  $R_{ON}$  as a Function of  $V_D$  ( $V_S$ ): Dual-Supply Voltage

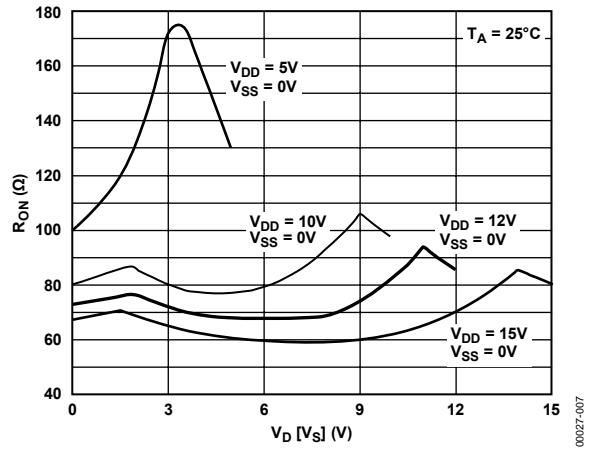

Figure 7.  $R_{ON}$  as a Function of  $V_D$  ( $V_S$ ): Single-Supply Voltage

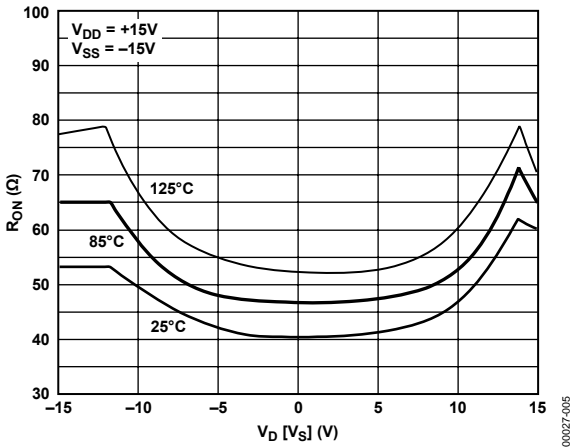

Figure 5.  $R_{ON}$  as a Function of  $V_D$  ( $V_S$ ) for Different Temperatures

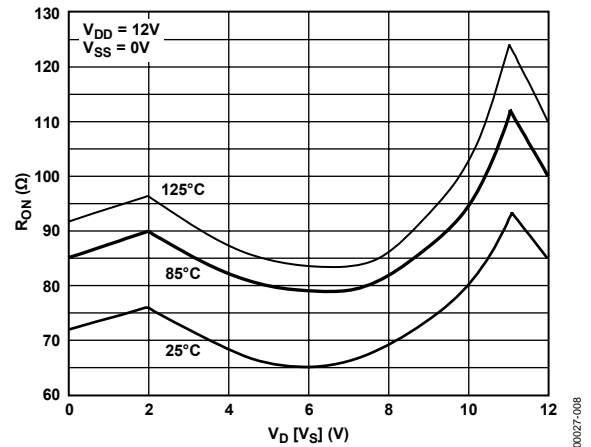

Figure 8.  $R_{ON}$  as a Function of  $V_D$  ( $V_S$ ) for Different Temperature

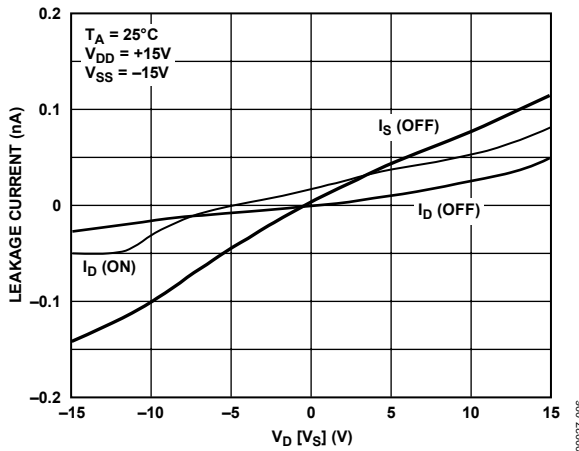

Figure 6. Leakage Currents as a Function of  $V_D$  ( $V_S$ )

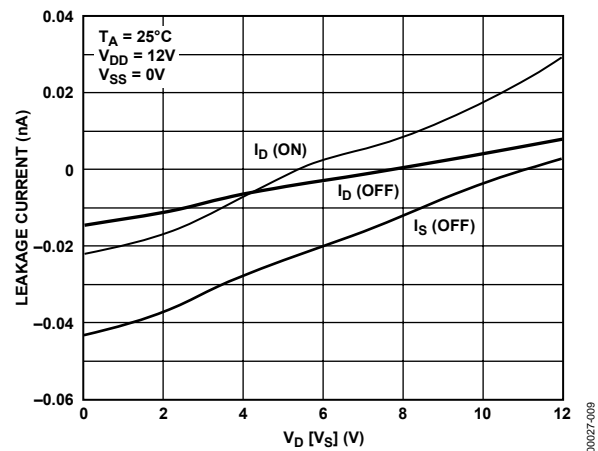

Figure 9. Leakage Currents as a Function of  $V_D$  ( $V_S$ )





Figure 10. Switching Time vs.  $V_{IN}$  (Bipolar Supply)



Figure 13. Switching Time vs.  $V_{IN}$  (Single Supply)



Figure 11. Switching Time vs. Single Supply



Figure 14. Switching Time vs. Bipolar Supply



Figure 12. Positive Supply Current vs. Switching Frequency



Figure 15. Negative Supply Current vs. Switching Frequency

# ADG408/ADG409

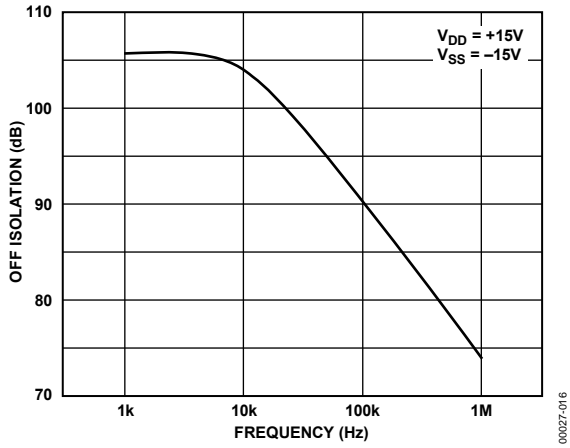

Figure 16. Off Isolation vs. Frequency

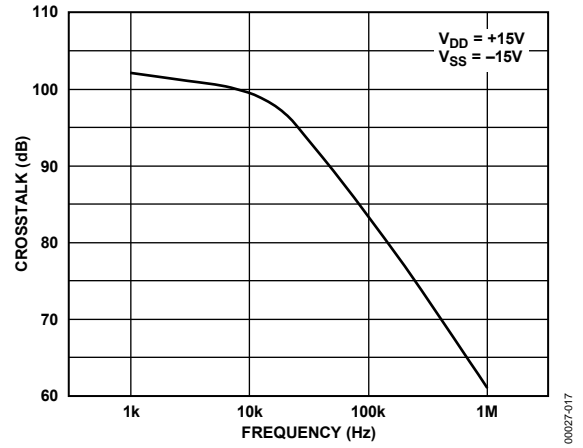

Figure 17. Crosstalk vs. Frequency

TEST CIRCUITS



Figure 18. On Resistance



Figure 20.  $I_b$  (OFF)

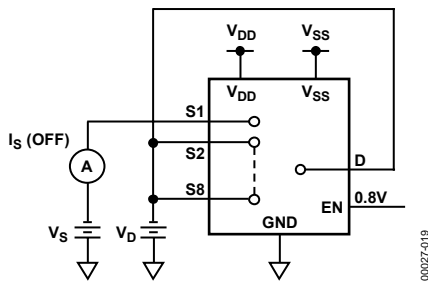

Figure 19.  $I_s$  (OFF)



Figure 21.  $I_b$  (ON)

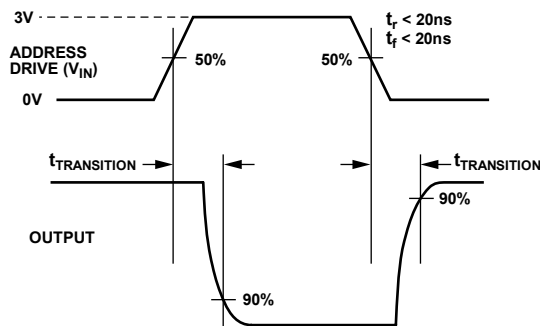

Figure 22. Switching Time of Multiplexer,  $t_{\text{TRANSITION}}$



<sup>1</sup>SIMILAR CONNECTION FOR ADG409.

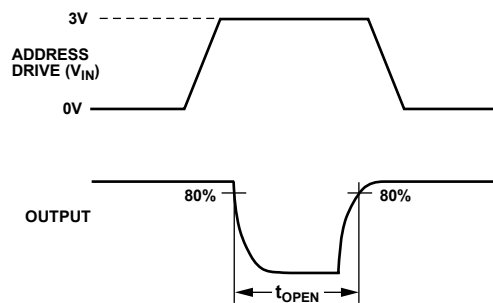

Figure 23. Break-Before-Make Delay,  $t_{\text{OPEN}}$



<sup>1</sup>SIMILAR CONNECTION FOR ADG409.

# ADG408/ADG409



<sup>1</sup>SIMILAR CONNECTION FOR ADG409.

00027-024

Figure 24. Enable Delay,  $t_{ON}(EN)$ ,  $t_{OFF}(EN)$

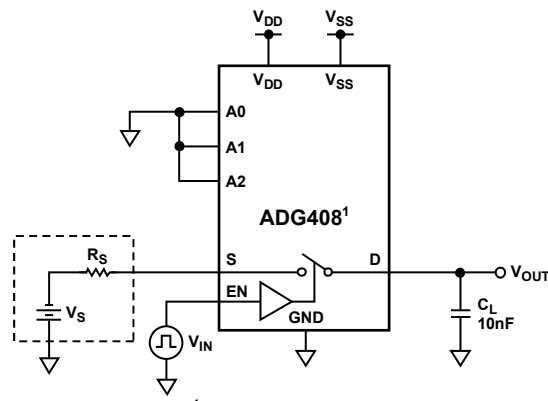

<sup>1</sup>SIMILAR CONNECTION FOR ADG409.

00027-025

Figure 25. Charge Injection



OFF ISOLATION =  $20 \log V_{OUT}/V_{IN}$

00027-026

Figure 26. Off Isolation



CROSSTALK =  $20 \log V_{OUT}/V_{IN}$

00027-027

Figure 27. Channel-to-Channel Crosstalk

## TERMINOLOGY

### $R_{ON}$

Ohmic resistance between D and S.

### $\Delta R_{ON}$

Difference between the  $R_{ON}$  of any two channels.

### $I_S$ (OFF)

Source leakage current when the switch is off.

### $I_D$ (OFF)

Drain leakage current when the switch is off.

### $I_D, I_S$ (ON)

Channel leakage current when the switch is on.

### $V_D$ ( $V_S$ )

Analog voltage on Terminal D and Terminal S.

### $C_S$ (OFF)

Channel input capacitance for off condition.

### $C_D$ (OFF)

Channel output capacitance for off condition.

### $C_D, C_S$ (ON)

On switch capacitance.

### $C_{IN}$

Digital input capacitance.

### $t_{ON}$ (EN)

Delay time between the 50% and 90% points of the digital input and switch on condition.

### $t_{OFF}$ (EN)

Delay time between the 50% and 90% points of the digital input and switch off condition.

### $t_{TRANSITION}$

Delay time between the 50% and 90% points of the digital inputs and the switch on condition when switching from one address state to another.

### $t_{OPEN}$

Off time measured between the 80% point of both switches when switching from one address state to another.

### $V_{INL}$

Maximum input voltage for Logic 0.

### $V_{INH}$

Minimum input voltage for Logic 1.

### $I_{INL}$ ( $I_{INH}$ )

Input current of the digital input.

### Crosstalk

A measure of unwanted signal that is coupled through from one channel to another as a result of parasitic capacitance.

### Off Isolation

A measure of unwanted signal coupling through an off channel.

### Charge Injection

A measure of the glitch impulse transferred from the digital input to the analog output during switching.

### $I_{DD}$

Positive supply current.

### $I_{SS}$

Negative supply current.

## OUTLINE DIMENSIONS

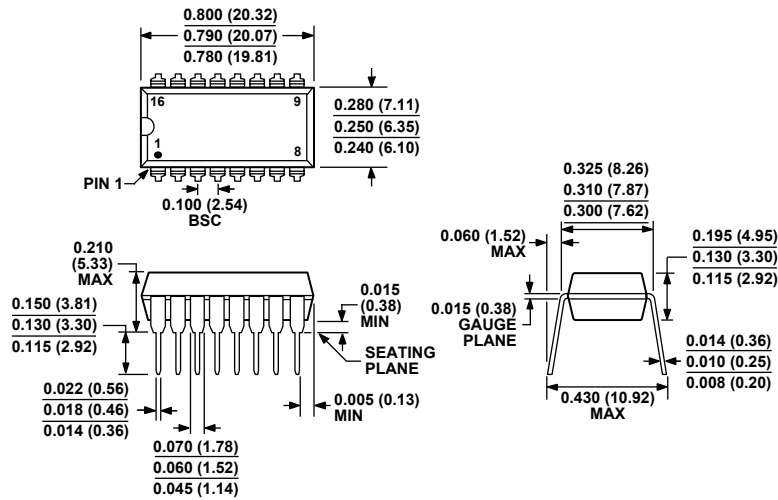

COMPLIANT TO JEDEC STANDARDS MS-001-AB  
 CONTROLLING DIMENSIONS ARE IN INCHES; MILLIMETER DIMENSIONS (IN PARENTHESES) ARE ROUNDED-OFF INCH EQUIVALENTS FOR REFERENCE ONLY AND ARE NOT APPROPRIATE FOR USE IN DESIGN. CORNER LEADS MAY BE CONFIGURED AS WHOLE OR HALF LEADS.

Figure 28. 16-Lead Plastic Dual In-Line Package [PDIP]  
 Narrow Body  
 (N-16)

Dimensions shown in inches and (millimeters)



CONTROLLING DIMENSIONS ARE IN INCHES; MILLIMETER DIMENSIONS (IN PARENTHESES) ARE ROUNDED-OFF INCH EQUIVALENTS FOR REFERENCE ONLY AND ARE NOT APPROPRIATE FOR USE IN DESIGN.

Figure 29. 16-Lead Ceramic Dual In-Line Package [CERDIP]  
 (Q-16)

Dimensions shown in inches and (millimeters)

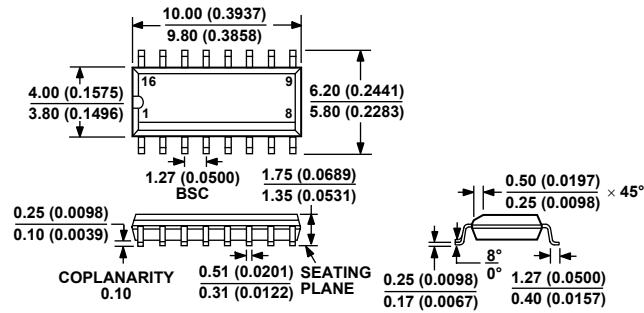

COMPLIANT TO JEDEC STANDARDS MS-012-AC  
 CONTROLLING DIMENSIONS ARE IN MILLIMETERS; INCH DIMENSIONS  
 (IN PARENTHESES) ARE ROUNDED-OFF MILLIMETER EQUIVALENTS FOR  
 REFERENCE ONLY AND ARE NOT APPROPRIATE FOR USE IN DESIGN.

Figure 30. 16-Lead Standard Small Outline Package [SOIC\_N]  
 Narrow Body  
 (R-16)

Dimensions shown in millimeters and (inches)



COMPLIANT TO JEDEC STANDARDS MO-153-AB

Figure 31. 16-Lead Thin Shrink Small Outline Package [TSSOP]  
 (RU-16)

Dimensions shown in millimeters

# ADG408/ADG409

## ORDERING GUIDE

Model	Temperature Range	Package Description	Package Option
ADG408BN	-40°C to +85°C	16-Lead Plastic Dual In-Line Package [PDIP]	N-16
ADG408BNZ <sup>1</sup>	-40°C to +85°C	16-Lead Plastic Dual In-Line Package [PDIP]	N-16
ADG408BR	-40°C to +85°C	16-Lead Narrow Body Small Outline Package [SOIC_N]	R-16
ADG408BR-REEL	-40°C to +85°C	16-Lead Narrow Body Small Outline Package [SOIC_N]	R-16
ADG408BR-REEL7	-40°C to +85°C	16-Lead Narrow Body Small Outline Package [SOIC_N]	R-16
ADG408BRU	-40°C to +85°C	16-Lead Thin Shrink Small Outline Package [TSSOP]	RU-16
ADG408BRU-REEL	-40°C to +85°C	16-Lead Thin Shrink Small Outline Package [TSSOP]	RU-16
ADG408BRU-REEL7	-40°C to +85°C	16-Lead Thin Shrink Small Outline Package [TSSOP]	RU-16
ADG408BRUZ <sup>1</sup>	-40°C to +85°C	16-Lead Thin Shrink Small Outline Package [TSSOP]	RU-16
ADG408BRUZ-REEL <sup>1</sup>	-40°C to +85°C	16-Lead Thin Shrink Small Outline Package [TSSOP]	RU-16
ADG408BRUZ-REEL7 <sup>1</sup>	-40°C to +85°C	16-Lead Thin Shrink Small Outline Package [TSSOP]	RU-16
ADG408BRZ <sup>1</sup>	-40°C to +85°C	16-Lead Narrow Body Small Outline Package [SOIC_N]	R-16
ADG408BRZ-REEL <sup>1</sup>	-40°C to +85°C	16-Lead Narrow Body Small Outline Package [SOIC_N]	R-16
ADG408BRZ-REEL7 <sup>1</sup>	-40°C to +85°C	16-Lead Narrow Body Small Outline Package [SOIC_N]	R-16
ADG408TQ	-55°C to +125°C	16-Lead Ceramic Dual In-Line Package [CERDIP]	Q-16
ADG408BCHIPS		DIE	
ADG409BN	-40°C to +85°C	16-Lead Plastic Dual In-Line Package [PDIP]	N-16
ADG409BNZ <sup>1</sup>	-40°C to +85°C	16-Lead Plastic Dual In-Line Package [PDIP]	N-16
ADG409BR	-40°C to +85°C	16-Lead Narrow Body Small Outline Package [SOIC_N]	R-16
ADG409BR-REEL	-40°C to +85°C	16-Lead Narrow Body Small Outline Package [SOIC_N]	R-16
ADG409BR-REEL7	-40°C to +85°C	16-Lead Narrow Body Small Outline Package [SOIC_N]	R-16
ADG409BRU	-40°C to +85°C	16-Lead Thin Shrink Small Outline Package [TSSOP]	RU-16
ADG409BRU-REEL	-40°C to +85°C	16-Lead Thin Shrink Small Outline Package [TSSOP]	RU-16
ADG409BRU-REEL7	-40°C to +85°C	16-Lead Thin Shrink Small Outline Package [TSSOP]	RU-16
ADG409BRUZ <sup>1</sup>	-40°C to +85°C	16-Lead Thin Shrink Small Outline Package [TSSOP]	RU-16
ADG409BRUZ-REEL <sup>1</sup>	-40°C to +85°C	16-Lead Thin Shrink Small Outline Package [TSSOP]	RU-16
ADG409BRUZ-REEL7 <sup>1</sup>	-40°C to +85°C	16-Lead Thin Shrink Small Outline Package [TSSOP]	RU-16
ADG409BRZ <sup>1</sup>	-40°C to +85°C	16-Lead Narrow Body Small Outline Package [SOIC_N]	R-16
ADG409BRZ-REEL <sup>1</sup>	-40°C to +85°C	16-Lead Narrow Body Small Outline Package [SOIC_N]	R-16
ADG409BRZ-REEL7 <sup>1</sup>	-40°C to +85°C	16-Lead Narrow Body Small Outline Package [SOIC_N]	R-16
ADG409TQ	-55°C to +125°C	16-Lead Ceramic Dual In-Line Package [CERDIP]	Q-16

<sup>1</sup> Z = Pb-free part.



## Данный компонент на территории Российской Федерации

### Вы можете приобрести в компании MosChip.

Для оперативного оформления запроса Вам необходимо перейти по данной ссылке:

<http://moschip.ru/get-element>

Вы можете разместить у нас заказ для любого Вашего проекта, будь то серийное производство или разработка единичного прибора.

В нашем ассортименте представлены ведущие мировые производители активных и пассивных электронных компонентов.

Нашей специализацией является поставка электронной компонентной базы двойного назначения, продукции таких производителей как XILINX, Intel (ex.ALTERA), Vicor, Microchip, Texas Instruments, Analog Devices, Mini-Circuits, Amphenol, Glenair.

Сотрудничество с глобальными дистрибьюторами электронных компонентов, предоставляет возможность заказывать и получать с международных складов практически любой перечень компонентов в оптимальные для Вас сроки.

На всех этапах разработки и производства наши партнеры могут получить квалифицированную поддержку опытных инженеров.

Система менеджмента качества компании отвечает требованиям в соответствии с ГОСТ Р ИСО 9001, ГОСТ РВ 0015-002 и ЭС РД 009

### Офис по работе с юридическими лицами:

105318, г.Москва, ул.Щербаковская д.3, офис 1107, 1118, ДЦ «Щербаковский»

Телефон: +7 495 668-12-70 (многоканальный)

Факс: +7 495 668-12-70 (доб.304)

E-mail: [info@moschip.ru](mailto:info@moschip.ru)

Skype отдела продаж:

moschip.ru

moschip.ru\_4

moschip.ru\_6

moschip.ru\_9