

NON-ISOLATED DC/DC CONVERTERS

5 Vdc - 13.8 Vdc Input 0.6 Vdc - 5.0 Vdc/40 A Output

bel
POWER PRODUCTS

xRP2-40E1A0

RoHS Compliant

Rev.D

- Non-Isolated
- High Efficiency
- Fixed Switching Frequency
- Low Cost
- Excellent Thermal Performance
- Wide Input Voltage Range
- Wide Output Trim Range
- Output Over-Voltage Shutdown
- OCP/SCP
- Low Output Ripple
- Power Good Signal
- Remote On/Off



Description

The xRP2-40E1A0 is a non-isolated dc/dc converter that operates over a wide range of input voltage ($V_{in} = 5 \text{ Vdc} - 13.8 \text{ Vdc}$). This unit can provide a precisely regulated output voltage from 0.6 Vdc to 5.0 Vdc and can deliver up to 40 A of output current. This unit is designed to be highly efficient and low cost. The converter is provided in an industry standard package.

Part Selection

Output Voltage	Input Voltage	Max. Output Current	Max. Output Power	Typical Efficiency ($V_o=1.8 \text{ Vdc}$)	Part Number Horizontal Mount	Part Number Vertical Mount
0.6 V - 5.0 V	5.0 V - 13.8 V	40 A	200 W	87%	0RP2-40E1A0	VRP2-40E1A0

- Notes:** 1. All part numbers above indicate RoHS 6. Change the second letter "R" to "7" for RoHS 5 part numbers.
2. Add "G" suffix at the end of the model numbers listed above to indicate "Tray Packaging".

Absolute Maximum Ratings

Parameter	Min	Typ	Max	Notes
Input Voltage (continuous)	-0.3 V	-	15 V	
Output Enable Terminal Voltage	-0.3 V	-	15 V	
Ambient Temperature	0 °C	-	70 °C	
Storage Temperature	-55 °C	-	125 °C	

Input Specifications

Parameter	Min	Typ	Max	Notes
Input Voltage				
$V_o \leq 2.8 \text{ V}$	5 V	12 V	13.8 V	
$V_o > 2.8 \text{ V}$	$1.8 \cdot V_o$	12 V	13.8 V	
Input Current (full load)	-	-	30 A	
Input Reflected Ripple Current (pk-pk)	-	35 mA	-	With simulated source impedance of 1 uH, 5 Hz to 20 MHz. Use a 1000 uF/16 V electrolytic capacitor with ESR=0.1 ohm max, at 100 kHz at 25°C.
Input Reflected Ripple Current (rms)	-	10 mA	-	
I^2t Inrush Current Transient	-	-	1 A ² s	
Turn-on Voltage Threshold	4.4 V	4.6 V	4.8 V	
Under Voltage Threshold	4.0 V	4.3 V	4.6 V	

Note: All specifications are typical at 25 °C unless otherwise stated.

NON-ISOLATED DC/DC CONVERTERS

5 Vdc - 13.8 Vdc Input

0.6 Vdc - 5.0 Vdc/40 A Output



Output Specifications

Parameter	Min	Typ	Max	Notes	
Output Voltage Set Point Vo ≥ 1 V Vo < 1 V	-1.5 % Vo -10 mV	- -	+1.5 % Vo +10 mV	Vin=Vinmin, Io=Iomax	
Load Regulation Vo ≥ 2.5 V Vo < 2.5 V	- -	- -	0.6% Vo 12 mV		
Line Regulation Vo ≥ 2.5 V Vo < 2.5 V	- -	- -	0.3% Vo 9 mV		
Regulation Over Temperature (0 °C to +70 °C)	-	-	0.02% Vo/C		
Output Current	0 A	-	40 A		
Current Limit Threshold	105% Io	130% Io	160% Io		
Output Ripple and Noise (pk-pk) Vo=5.0 V Vo=3.3 V Vo=2.5 V Vo=1.5 V Vo=1.0 V Vo=0.6 V	- - - - - -	- - - - - -	120 mV 60 mV 40 mV 40 mV 30 mV 30 mV	Test conditions: 0-20MHz BW, with a 1µF ceramic capacitor and a 10 uF Tantalum cap at output.	
Output Ripple and Noise (rms) Vo=5.0 V Vo=3.3 V Vo=2.5 V Vo=1.5 V Vo=1.0 V Vo=0.6 V	- - - - - -	- - - - - -	30 mV 30 mV 20 mV 20 mV 15 mV 15 mV		
Turn On Time	-	-	10 mS		
Rise Time	-	-	3 mS		
Overshoot at Turn on and off	-	-	0.5%		
Output Capacitance ESR ≥ 1 mΩ	0 uF	-	4700 uF		
Transient Response					
0% ~ 50% Max Load	Vo=All	-	-	300 mV	Test conditions: di/dt = 10 A/uS; Vin =12 V;
Settling Time		-	-	100 uS	
50% ~ 0% Max Load		-	-	300 mV	
Settling Time		-	-	100 uS	

Note: All specifications are typical at 25 °C unless otherwise stated.

NON-ISOLATED DC/DC CONVERTERS

5 Vdc - 13.8 Vdc Input 0.6 Vdc - 5.0 Vdc/40 A Output



General Specifications

Parameter	Min	Typ	Max	Notes
Efficiency				Measured at Vin=12 V, full load.
Vo=5.0 V	91%	94%	-	
Vo=3.3 V	89%	92%	-	
Vo=2.5 V	87%	90%	-	
Vo=1.8 V	84%	87%	-	
Vo=1.5 V	82%	85%	-	
Vo=1.2 V	79%	82%	-	
Vo=1.0 V	76%	79%	-	
Vo=0.6 V	68%	71%	-	
Switching Frequency	-	500 kHz	-	
Output Voltage Trim Range	0.6 V	-	5 V	Trim pin is open, Vo = 0.6 V.
Over Voltage Protection	110% Vo,set	115%Vo,set	130%Vo,set	Vin=12 V, Io=full load.
MTBF	2,392,000 hours			Calculated Per Bell Core SR-332 (Io = 80%Iomax; Vin=12 V; Ta = 25 °C;ORP2-40E1A0)
	3,061,000 hours			Calculated Per Bell Core SR-332 (Io = 80%Iomax; Vin=12 V; Ta = 25 °C;VRP2-40E1A0)
Dimensions (horizontal mount)				
Inches (L x W x H)	1.45 x 1.10 x 0.50			
Millimeters (L x W x H)	36.83 x 27.94 x 12.7			
Dimensions (vertical mount)				
Inches (L x W x H)	1.45 x 1.10 x 0.377			
Millimeters (L x W x H)	36.83 x 27.94 x 9.58			
Weight	-	19 g	-	

Note: All specifications are typical at 25 °C unless otherwise stated.

Control Specifications

Parameter	Min	Typ	Max	Notes
Remote On/Off (Active High)				
Signal Low (Unit Off)	-0.3 V	-	0.8 V	Remote On/Off pin is open, unit is off.
Signal High (Unit On)	2.0 V	-	Vin,max	
Current Source/Sink	0 mA	-	3.3 mA	
PwGood (PowerGood)				
PwGood = High = Power Good	2.4 V	-	5.25 V	
	-	-	2 mA	
PwGood = Low = Power Not Good	0 V	-	0.4 V	
	-	-	4 mA	

Output Trim Equation

The Trim resistor should be connected between the Trim+ pin and Trim- pin.

$$R_{trim} = \frac{1.2}{V_o - 0.6} (K\Omega)$$

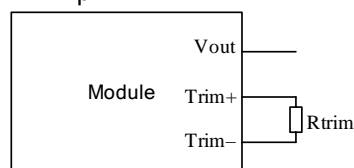

NON-ISOLATED DC/DC CONVERTERS

5 Vdc - 13.8 Vdc Input

0.6 Vdc - 5.0 Vdc/40 A Output



Efficiency Data

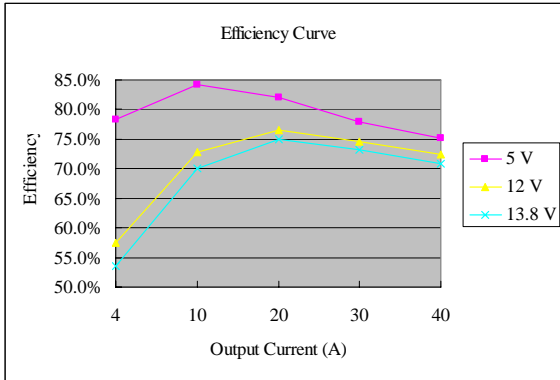

Vout = 0.6 V

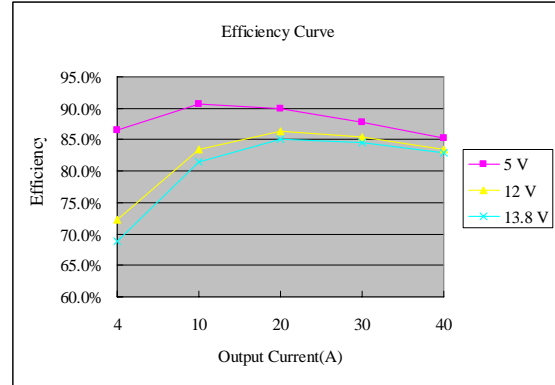

Vout = 1.2 V

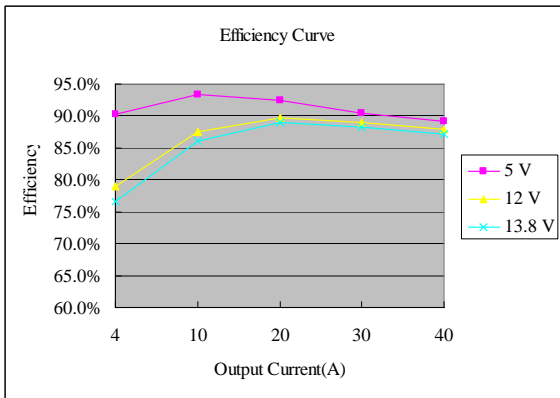

Vout = 1.8 V

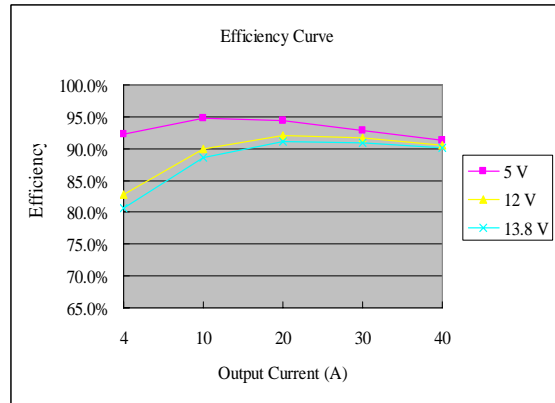

Vout = 2.5 V

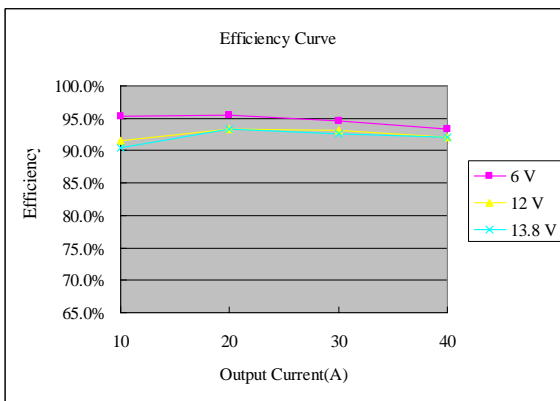

Vout = 3.3 V

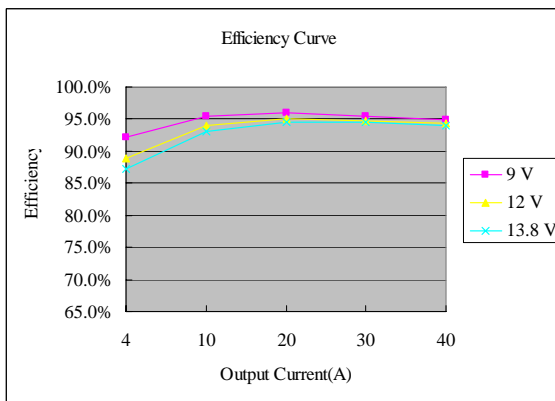

Vout = 5.0 V

NON-ISOLATED DC/DC CONVERTERS

5 Vdc - 13.8 Vdc Input

0.6 Vdc - 5.0 Vdc/40 A Output



Thermal Derating Curves

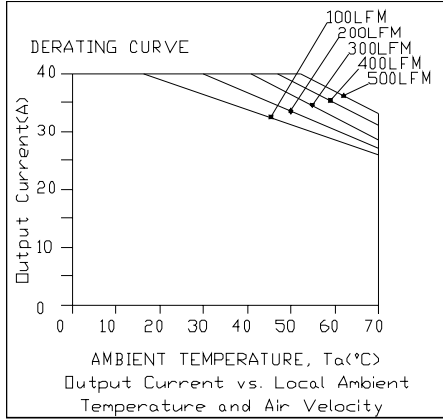

Vin=12 V, Vo=0.6 V

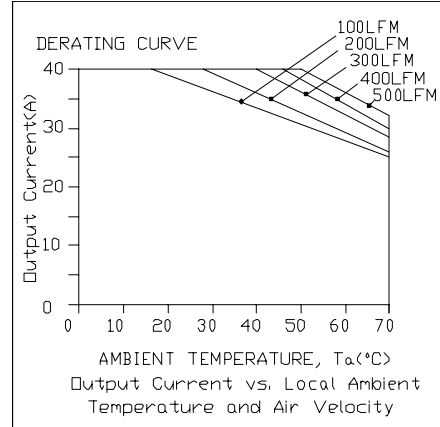

Vin=12 V, Vo=1.2 V

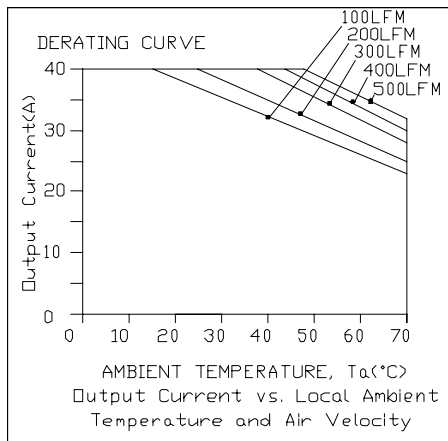

Vin=12 V, Vo=1.8 V

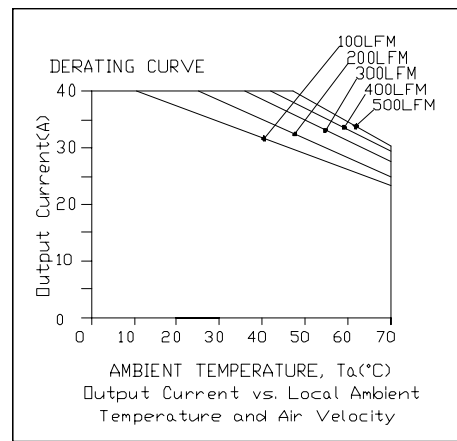

Vin=12 V, Vo=2.5 V

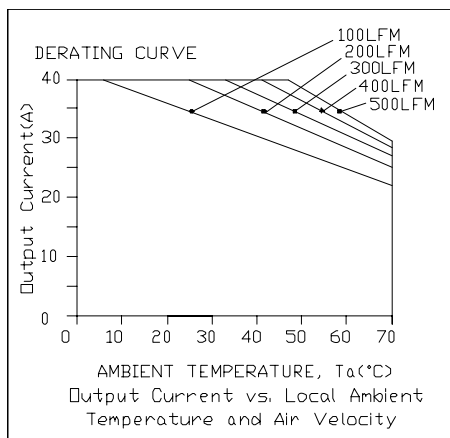

Vin=12 V, Vo=3.3 V

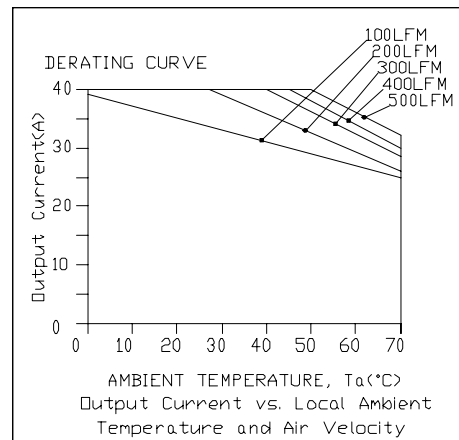

Vin=12 V, Vo=5.0 V

NON-ISOLATED DC/DC CONVERTERS

5 Vdc - 13.8 Vdc Input

0.6 Vdc - 5.0 Vdc/40 A Output



Ripple and Noise Waveforms

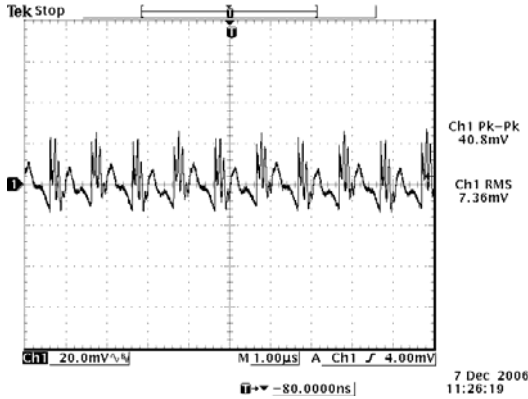

12 Vdc input, 0.6 Vdc/40 A output

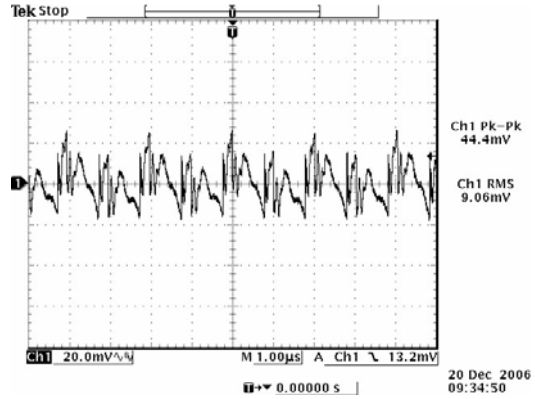

12 Vdc input, 1.2 Vdc/40 A output

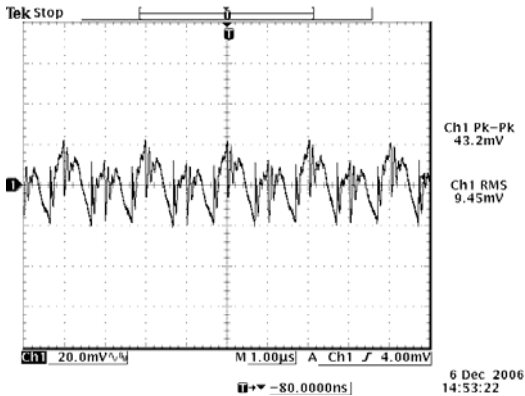

12 Vdc input, 1.8 Vdc/40 A output

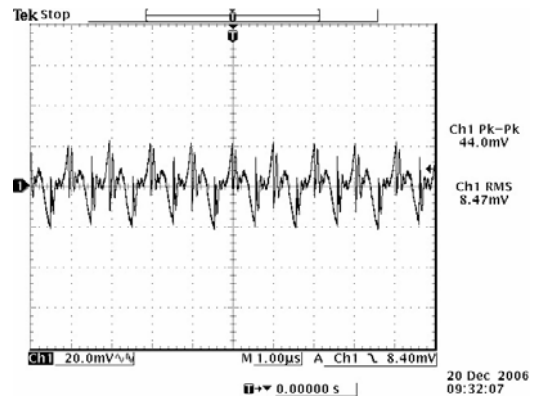

12 Vdc input, 2.5 Vdc/40 A output

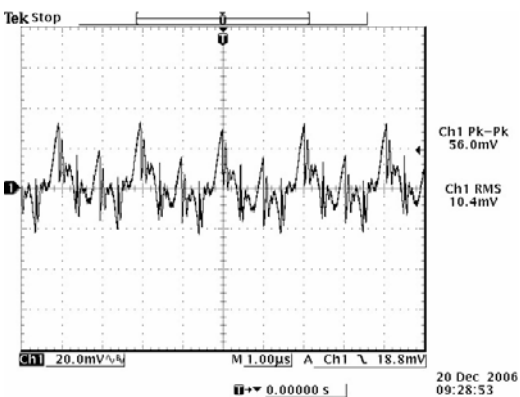

12 Vdc input, 3.3 Vdc/40 A output

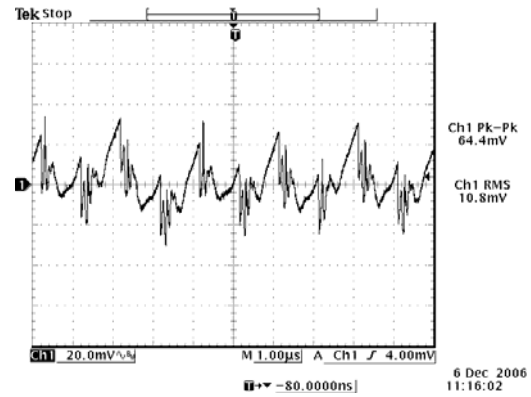

12 Vdc input, 5.0 Vdc/40 A output

Note: Ripple and noise at full load, 0-20 MHz BW, with a 10 uF tantalum cap and a 1uF ceramic cap at the output, and Ta=25 deg C.

NON-ISOLATED DC/DC CONVERTERS

5 Vdc - 13.8 Vdc Input

0.6 Vdc - 5.0 Vdc/40 A Output



Transient Response Waveforms

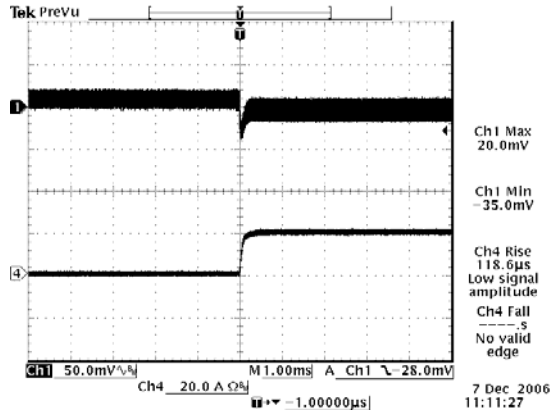

Vout= 0.6 V 0%-50% Load Transients

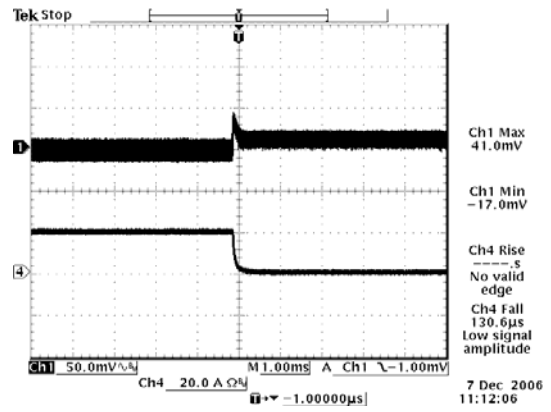

Vout=0.6 V 50%-0% Load Transients

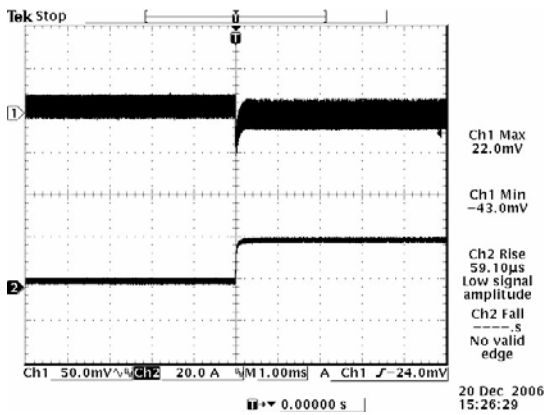

Vout=1.2 V 0%-50% Load Transients

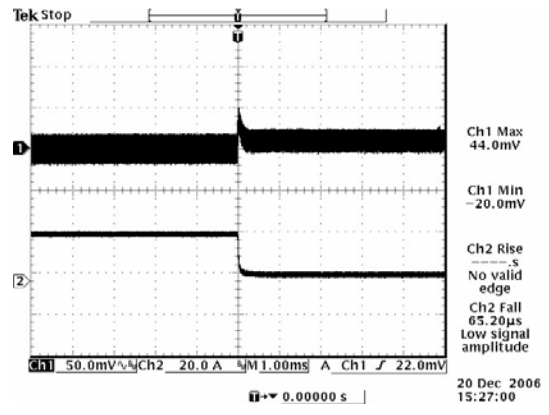

Vout=1.2 V 50%-0% Load Transients

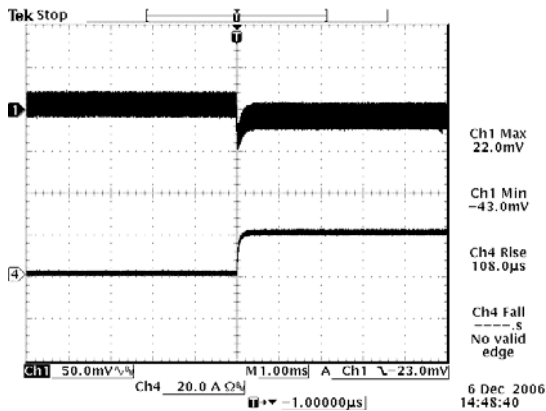

Vout=1.8 V 0%-50% Load Transients

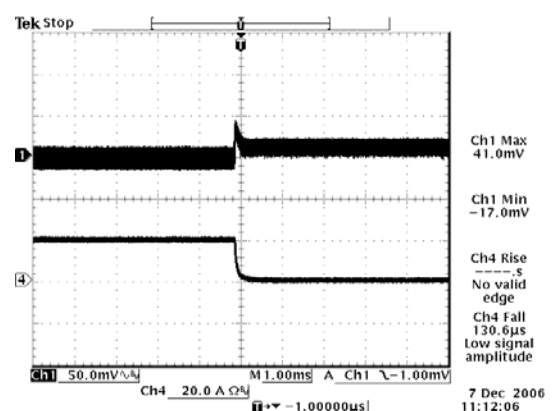

Vout=1.8 V 50%-0% Load Transients

NON-ISOLATED DC/DC CONVERTERS

5 Vdc - 13.8 Vdc Input

0.6 Vdc - 5.0 Vdc/40 A Output



Transient Response Waveforms (continued)

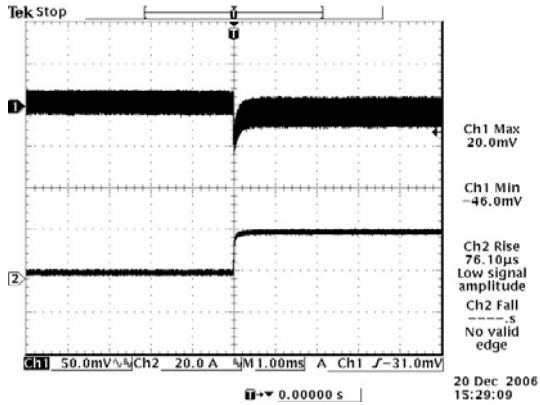

Vout= 2.5 V 0%-50% Load Transients

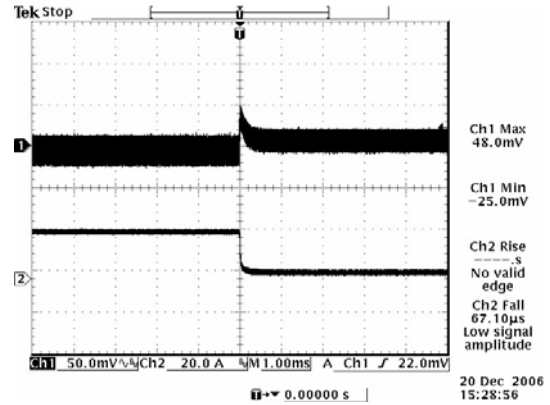

Vout=2.5 V 50%-0% Load Transients

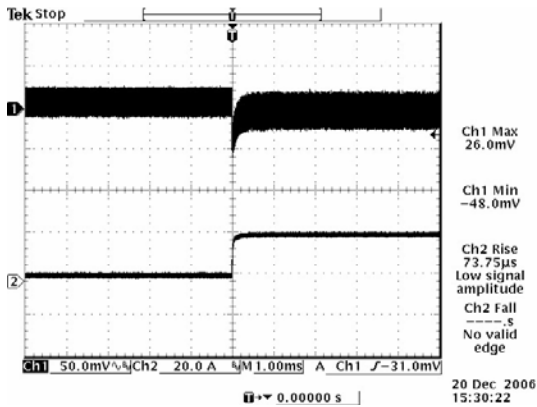

Vout=3.3 V 0%-50% Load Transients

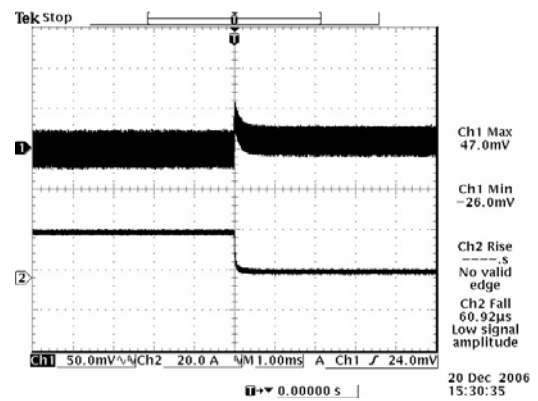

Vout=3.3 V 50%-0% Load Transients

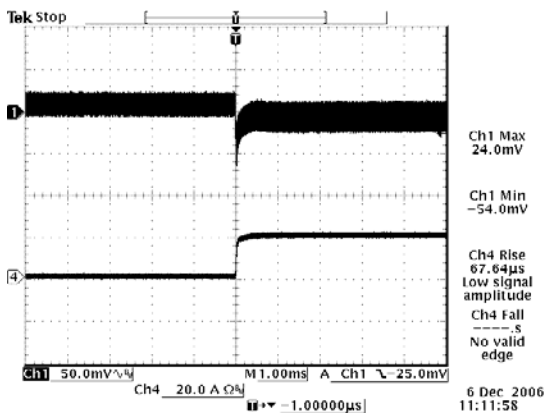

Vout=5 V 0%-50% Load Transients

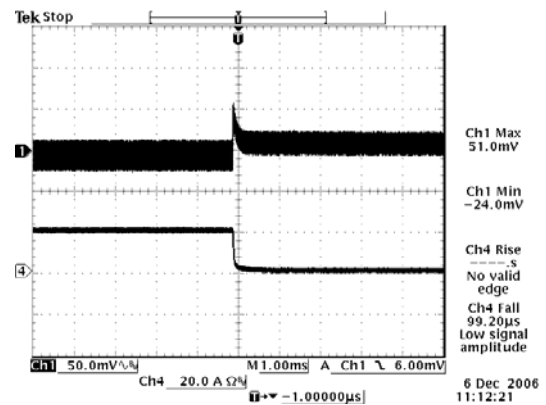

Vout=5 V 50%-0% Load Transients

Note: Transient response at $di/dt = 10 A/\mu S$, with external electrolytic cap 4700 μF , and $T_a=25$ deg C.

NON-ISOLATED DC/DC CONVERTERS

5 Vdc - 13.8 Vdc Input 0.6 Vdc - 5.0 Vdc/40 A Output



Mechanical Outline

0RP2-40E1A0

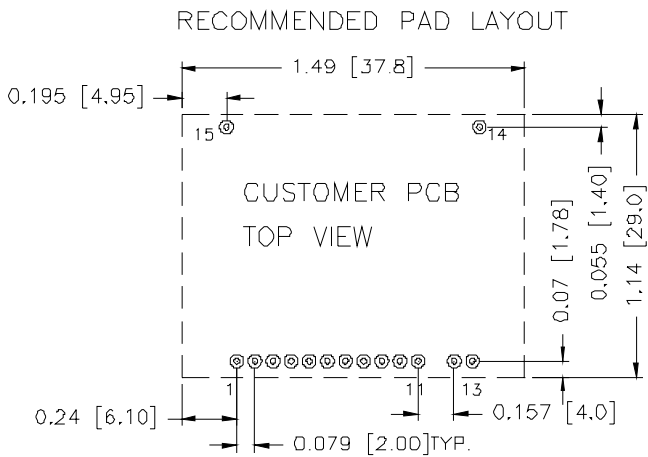
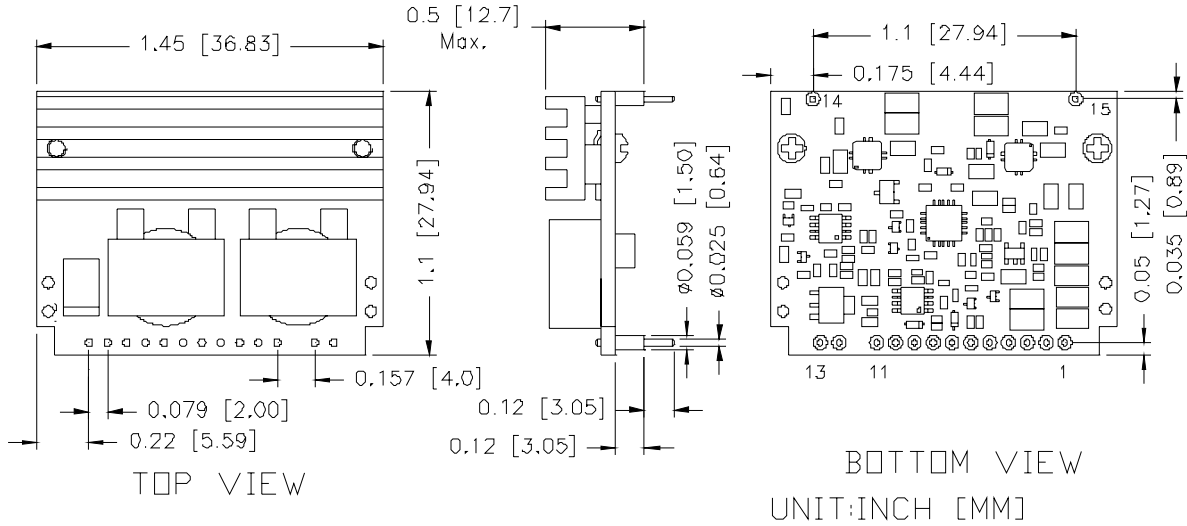

2 SUPPORT PAD THR. HOLES $\varnothing 0.085$ [$\varnothing 2.2$] BOTH SIDE
 13 PIN PAD THR. HOLES: $\varnothing 0.032$ [$\varnothing 0.8$] BOTH SIDE

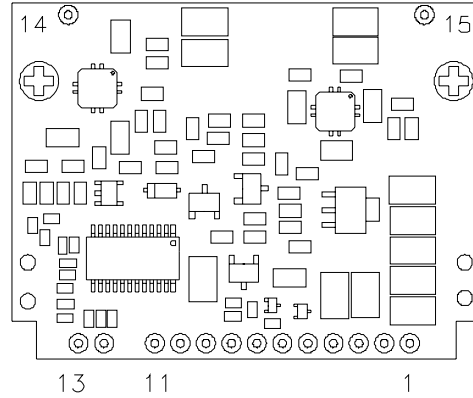

Pin Connections

Pin	Function	Pin	Function
1	Vout	9	PwGOOD
2	Vout	10	Sense-
3	Vout	11	Sense+
4	GND	12	Vin
5	GND	13	Vin
6	Enable	14	GND
7	Trim-	15	GND
8	Trim+		

NON-ISOLATED DC/DC CONVERTERS

5 Vdc - 13.8 Vdc Input

0.6 Vdc - 5.0 Vdc/40 A Output



Mechanical Outline

VRP2-40E1A0

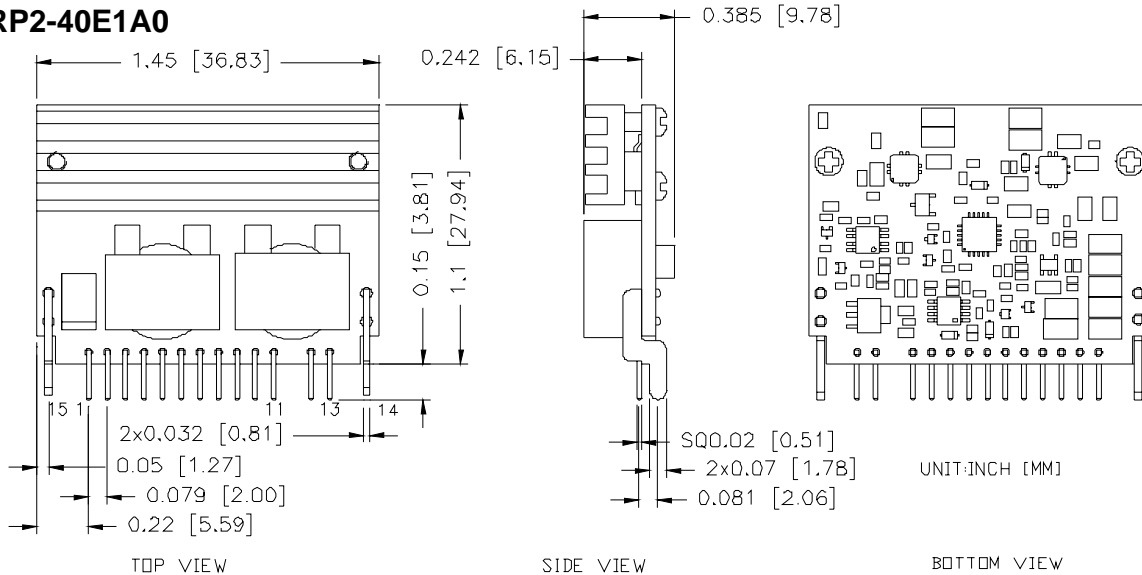

RECOMMENDED PAD LAYOUT

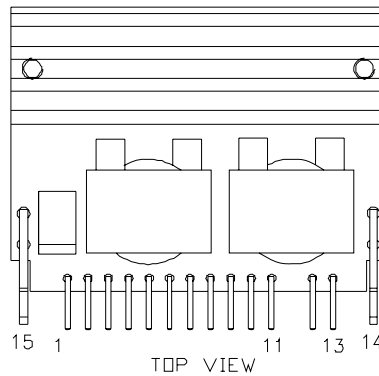
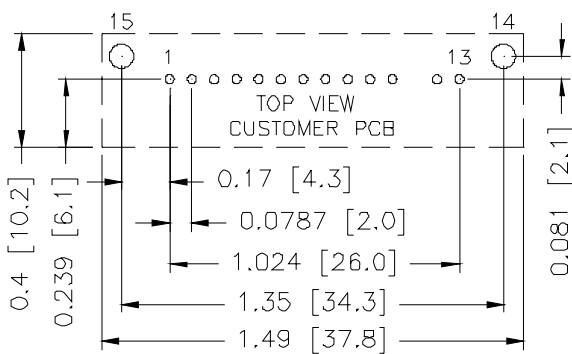

Pin Connections

Pin	Function
1	Vout
2	Vout
3	Vout
4	GND
5	GND
6	Enable
7	Trim-
8	Trim+
9	PwGOOD
10	Sense-
11	Sense+
12	Vin
13	Vin
14	GND
15	GND

14 15 SUPPORT PAD THR. HOLES ϕ 0.085 [2.2] BOTH SIDE

1~13 PIN PAD THR. HOLES: ϕ 0.032 [0.8] BOTH SIDE

RoHS Compliance

Complies with the European Directive 2002/95/EC, calling for the elimination of lead and other hazardous substances from electronic products.



©2009 Bel Fuse Inc. Specifications subject to change without notice. 103009

CORPORATE

Bel Fuse Inc.
206 Van Vorst Street
Jersey City, NJ 07302
Tel 201-432-0463
Fax 201-432-9542
www.belfuse.com

FAR EAST

Bel Fuse Ltd.
8F/ 8 Luk Hop Street
San Po Kong
Kowloon, Hong Kong
Tel 852-2328-5515
Fax 852-2352-3706
www.belfuse.com

EUROPE

Bel Fuse Europe Ltd.
Preston Technology Management Centre
Marsh Lane, Suite G7, Preston
Lancashire, PR1 8UD, U.K.
Tel 44-1772-556601
Fax 44-1772-888366
www.belfuse.com

Данный компонент на территории Российской Федерации

Вы можете приобрести в компании MosChip.

Для оперативного оформления запроса Вам необходимо перейти по данной ссылке:

<http://moschip.ru/get-element>

Вы можете разместить у нас заказ для любого Вашего проекта, будь то серийное производство или разработка единичного прибора.

В нашем ассортименте представлены ведущие мировые производители активных и пассивных электронных компонентов.

Нашей специализацией является поставка электронной компонентной базы двойного назначения, продукции таких производителей как XILINX, Intel (ex.ALTERA), Vicor, Microchip, Texas Instruments, Analog Devices, Mini-Circuits, Amphenol, Glenair.

Сотрудничество с глобальными дистрибьюторами электронных компонентов, предоставляет возможность заказывать и получать с международных складов практически любой перечень компонентов в оптимальные для Вас сроки.

На всех этапах разработки и производства наши партнеры могут получить квалифицированную поддержку опытных инженеров.

Система менеджмента качества компании отвечает требованиям в соответствии с ГОСТ Р ИСО 9001, ГОСТ РВ 0015-002 и ЭС РД 009

Офис по работе с юридическими лицами:

105318, г.Москва, ул.Щербаковская д.3, офис 1107, 1118, ДЦ «Щербаковский»

Телефон: +7 495 668-12-70 (многоканальный)

Факс: +7 495 668-12-70 (доб.304)

E-mail: info@moschip.ru

Skype отдела продаж:

moschip.ru

moschip.ru_4

moschip.ru_6

moschip.ru_9