



BIPOLAR ANALOG INTEGRATED CIRCUIT UPC2763TB

3 V, SUPER MINIMOLD MEDIUM POWER SI MMIC AMPLIFIER

FEATURES

- **HIGH OUTPUT POWER:** $P_{SAT} = +11$ dBm at 900 MHz
- **LOW VOLTAGE:** 3.0 V TYP, 2.7 V MIN
- **WIDE BANDWIDTH:** 2.7 GHz at -3 dB
- **HIGH GAIN:** 20 dB at 1.9 GHz
- **SUPER SMALL PACKAGE:** SOT-363 package
- **TAPE AND REEL PACKAGING OPTION AVAILABLE**

DESCRIPTION

The UPC2763TB is a Silicon Monolithic integrated circuit which is manufactured using the NESAT™ III process. The NESAT™ III process produces transistors with f_T approaching 20 GHz. The UPC2763TB is pin compatible and has comparable performance to the larger UPC2763T, so it is suitable for use as a replacement to help reduce system size. The IC is housed in a 6 pin super minimold or SOT-363 package. Operating on a 3 volt supply this IC is ideally suited for hand-held, portable designs.

Stringent quality assurance and test procedures ensure the highest reliability and performance.

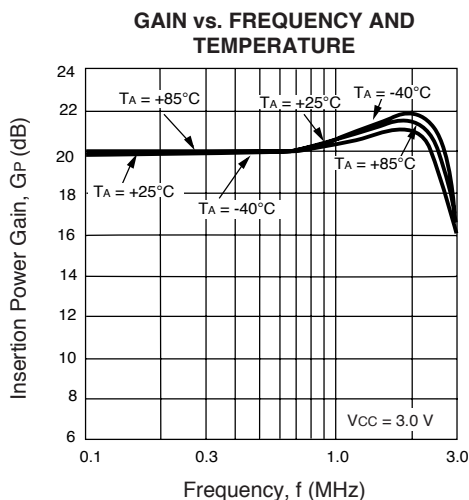

ELECTRICAL CHARACTERISTICS ($T_A = 25^\circ\text{C}$, $Z_L = Z_S = 50 \Omega$, $V_{CC} = 3.0$ V)

PART NUMBER PACKAGE OUTLINE			UPC2763TB S06		
SYMBOLS	PARAMETERS AND CONDITIONS	UNITS	MIN	TYP	MAX
I _{CC}	Circuit Current (no signal)	mA		27	35
G _S	Small Signal Gain, f = 900 MHz	dB	18	20	23
	f = 1900 MHz	dB	18	21	24
f _U	Upper Limit Operating Frequency (The gain at f _U is 3 dB down from the gain at 0.1 GHz)	GHz	2.3	2.7	
P _{1dB}	Output Power at 1 dB Compression Point, f = 900 MHz	dBm	+7	+9.5	
	f = 1900 MHz	dBm	+4	+6.5	
P _{SAT}	Saturated Output Power, f = 900 MHz	dBm		11	
	f = 1900 MHz	dBm		8	
NF	Noise Figure, f = 900 MHz	dB		5.5	7.0
	f = 1900 MHz	dB		5.5	7.5
RL _{IN}	Input Return Loss, f = 900 MHz	dB	8	11	
	f = 1900 MHz	dB	8	11	
RL _{OUT}	Output Return Loss, f = 900 MHz	dB	5	7	
	f = 1900 MHz	dB	6	9	
ISOL	Isolation, f = 900 MHz	dB	25	30	
	f = 1900 MHz	dB	24	29	
OIP ₃	SSB Output Third Order Intercept Point P _{OUT} = +4 dBm	dBm		+17	
	f = 900, 902 MHz	dBm		+11	
	f = 1900, 1902 MHz	dBm			
P _{ADJ}	Adjacent Channel Power, Δf = ±50 KHz	dBc		-61	
	f = 900 MHz, π/4 QPSK wave ¹ , Δf = ±100 KHz	dBc		-62	
	P _O = +4 dBm				

Note:

1. π/4 QPSK modulated wave input, data rate 42 kbps.

ABSOLUTE MAXIMUM RATINGS¹ (T_A = 25°C)

SYMBOLS	PARAMETERS	UNITS	RATINGS
V _{CC}	Supply Voltage	V	3.6
I _{CC}	Total Supply Current	mA	70
P _{IN}	Input Power	dBm	+10
P _T	Total Power Dissipation ²	mW	200
T _{OP}	Operating Temperature	°C	-40 to +85
T _{STG}	Storage Temperature	°C	-55 to +150

Notes:

1. Operation in excess of any one of these parameters may result in permanent damage.
2. Mounted on a 50 x 50 x 1.6 mm epoxy glass PWB (T_A = 85°C).

RECOMMENDED OPERATING CONDITIONS

SYMBOLS	PARAMETERS	UNITS	MIN	TYP	MAX
V _{CC}	Supply Voltage	V	2.7	3	3.3
T _{OP}	Operating Temperature	°C	-40	25	85

TEST CIRCUIT

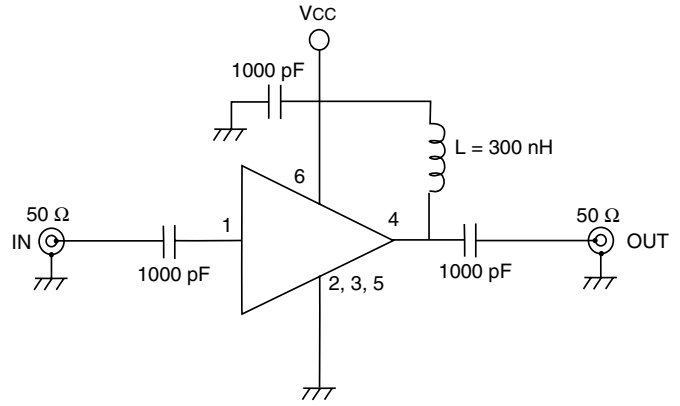

TYPICAL PERFORMANCE CURVES (T_A = 25°C)

CIRCUIT CURRENT vs. SUPPLY VOLTAGE

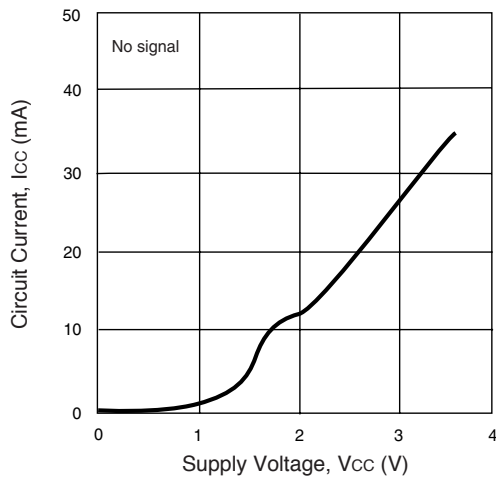

CIRCUIT CURRENT vs. OPERATING TEMPERATURE

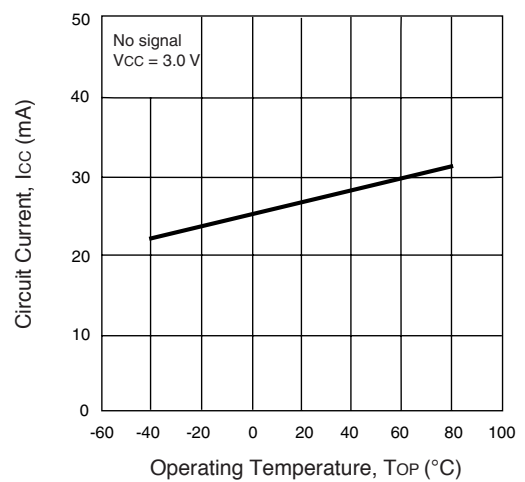

NOISE FIGURE AND INSERTION POWER GAIN vs. FREQUENCY AND VOLTAGE

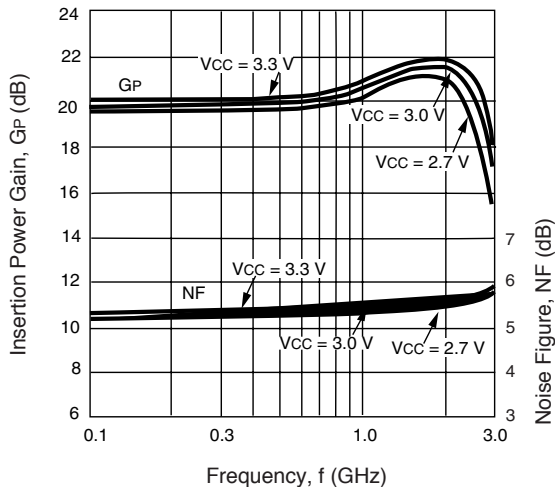

INPUT AND OUTPUT RETURN LOSS vs. FREQUENCY

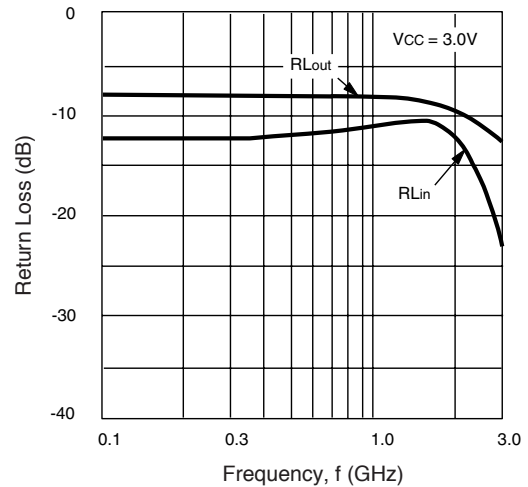

TYPICAL PERFORMANCE CURVES (TA = 25°C)

ISOLATION vs. FREQUENCY

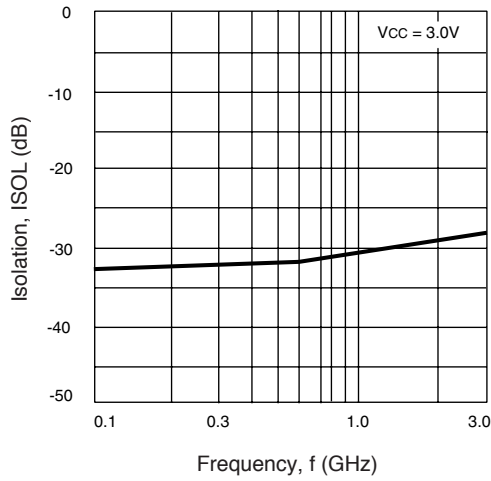

OUTPUT POWER vs. INPUT POWER AND VOLTAGE

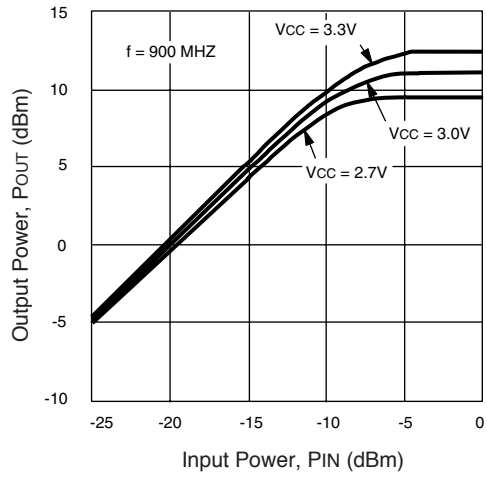

OUTPUT POWER vs. INPUT POWER AND TEMPERATURE

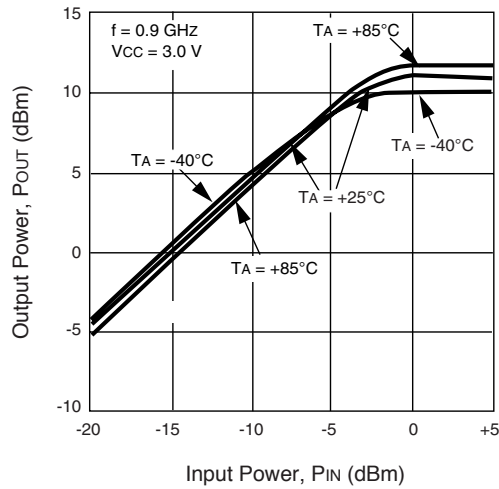

OUTPUT POWER vs. INPUT POWER AND VOLTAGE

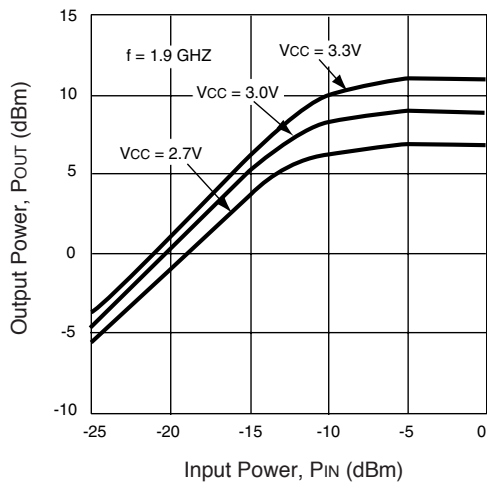

OUTPUT POWER vs. INPUT POWER AND TEMPERATURE

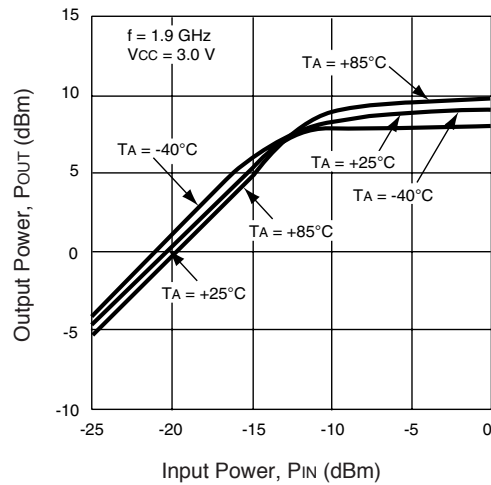

SATURATED OUTPUT POWER vs. FREQUENCY AND VOLTAGE

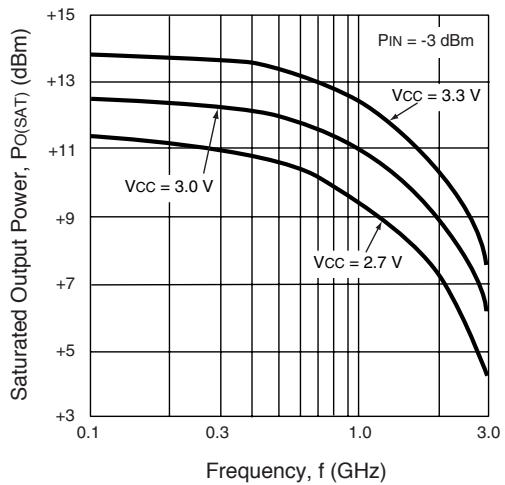

TYPICAL PERFORMANCE CURVES ($T_A = 25^\circ\text{C}$)

SATURATED OUTPUT POWER vs. FREQUENCY AND TEMPERATURE

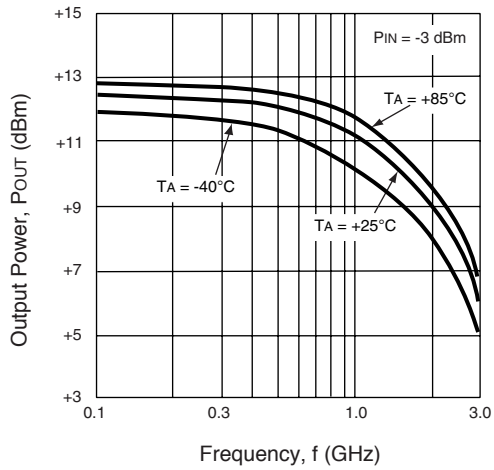

THIRD ORDER INTERMODULATION DISTORTION vs. OUTPUT POWER OF EACH TONE AND VOLTAGE

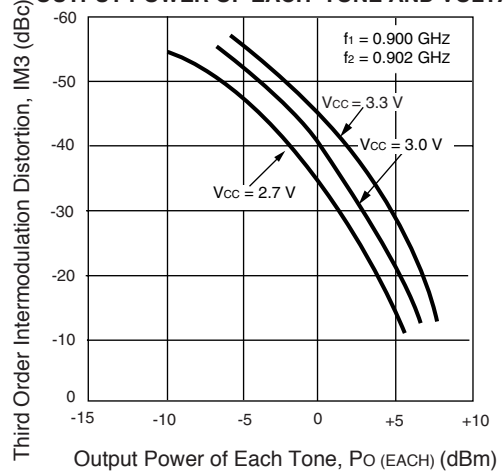

THIRD ORDER INTERMODULATION DISTORTION vs. OUTPUT POWER OF EACH TONE AND VOLTAGE

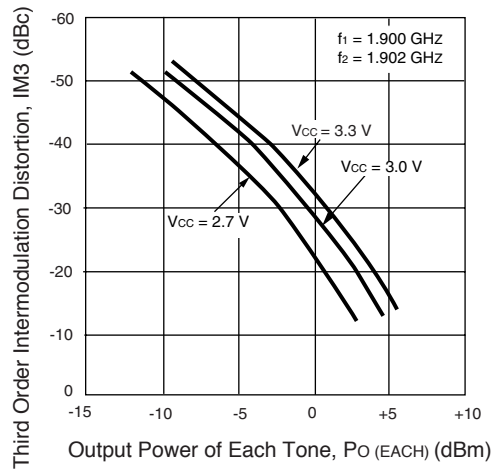

TYPICAL SCATTERING PARAMETERS (TA = +25°C, VCC = VOUT = 3.0 V)

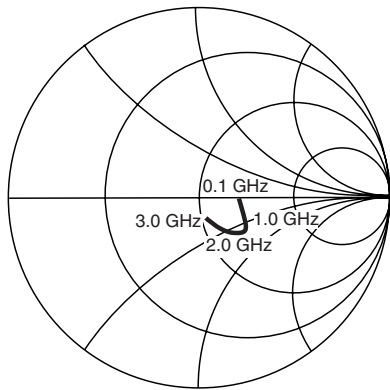

S11

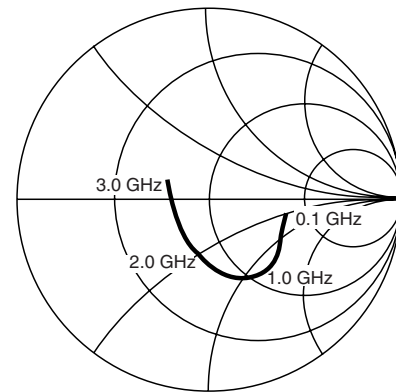

S22

VCC = VOUT = 3.0 V, ICC = 28 mA

FREQUENCY GHz	S11		S21		S12		S22		K
	MAG	ANG	MAG	ANG	MAG	ANG	MAG	ANG	
0.1	0.231	-1.4	10.210	-3.8	0.023	2.4	0.406	-4.1	1.68
0.2	0.242	-0.2	10.305	-8.5	0.023	7.8	0.412	-7.5	1.66
0.3	0.250	2.7	10.464	-12.9	0.024	9.3	0.407	-9.9	1.58
0.4	0.425	2.8	10.655	-18.2	0.024	13.4	0.407	-13.9	1.55
0.5	0.242	2.0	10.863	-22.8	0.026	16.1	0.405	-17.6	1.44
0.6	0.241	-2.2	11.093	-28.1	0.027	19.9	0.414	-21.6	1.37
0.7	0.263	-5.3	11.544	-33.2	0.028	22.3	0.419	-24.6	1.25
0.8	0.291	-5.6	11.843	-39.0	0.029	22.5	0.424	-27.7	1.16
0.9	0.316	-5.1	12.291	-45.1	0.029	23.9	0.424	-31.9	1.09
1.0	0.322	-4.0	12.676	-52.4	0.030	25.6	0.425	-37.1	1.02
1.1	0.318	-5.4	13.066	-59.8	0.031	24.1	0.438	-42.5	0.96
1.2	0.309	-9.0	13.311	-67.3	0.031	27.0	0.442	-47.8	0.96
1.3	0.322	-14.2	13.661	-75.8	0.033	28.8	0.441	-51.2	0.90
1.4	0.344	-20.6	13.845	-83.9	0.033	28.5	0.434	-56.0	0.87
1.5	0.371	-23.7	13.824	-93.0	0.035	30.1	0.435	-62.2	0.82
1.6	0.380	-27.5	13.890	-101.5	0.035	28.1	0.439	-68.9	0.80
1.7	0.388	-30.6	13.634	-110.5	0.036	29.2	0.439	-74.6	0.78
1.8	0.378	-36.4	13.236	-119.6	0.035	29.9	0.428	-81.3	0.84
1.9	0.378	-42.1	12.724	-127.9	0.035	30.9	0.411	-87.0	0.89
2.0	0.375	-46.6	12.290	-136.1	0.035	32.9	0.393	-93.4	0.94
2.1	0.369	-50.5	11.707	-144.0	0.035	33.0	0.385	-99.6	0.99
2.2	0.351	-53.8	11.130	-151.7	0.036	35.7	0.373	-104.9	1.06
2.3	0.331	-59.8	10.524	-159.1	0.036	36.8	0.359	-110.3	1.13
2.4	0.306	-66.4	9.824	-165.9	0.034	38.7	0.336	-117.5	1.31
2.5	0.300	-73.1	9.152	-172.3	0.035	40.1	0.321	-123.3	1.41
2.6	0.294	-75.8	8.583	-178.2	0.034	43.8	0.306	-129.4	1.55
2.7	0.290	-77.1	8.029	176.2	0.035	46.3	0.299	-133.9	1.58
2.8	0.270	-77.7	7.610	170.6	0.037	47.7	0.288	-138.6	1.63
2.9	0.248	-78.7	7.240	166.1	0.039	51.1	0.270	-143.6	1.67
3.0	0.219	-82.3	6.827	161.2	0.039	53.6	0.253	-150.1	1.79
3.1	0.198	-88.7	6.516	156.9	0.040	55.1	0.244	-156.2	1.88

OUTLINE DIMENSIONS (Units in mm)

LEAD CONNECTIONS

PACKAGE OUTLINE S06

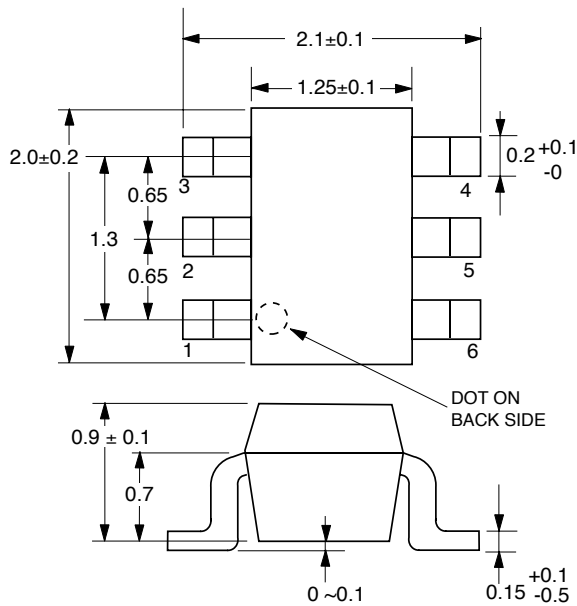

(Top View)

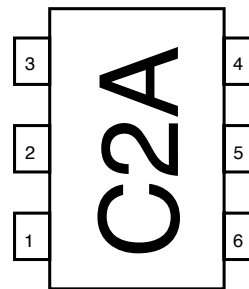

(Bottom View)

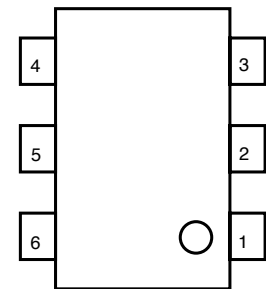

- 1. INPUT
- 2. GND
- 3. GND
- 4. OUTPUT
- 5. GND
- 6. Vcc

PIN DESCRIPTIONS

Pin No.	Pin Name	Applied Voltage (V)	Description	Internal Equivalent Circuit
1	Input	–	Signal input pin. An internal matching circuit, configured with resistors, enables 50 Ω connection over a wide bandwidth. A multi-feedback circuit is designed to cancel the deviations of hFE and resistance. This pin must be coupled to the signal source with a blocking capacitor.	
4	Output	2.7 to 3.3	Signal output pin. Connect an inductor between this pin and Vcc to supply current to the internal output transistors.	
6	Vcc		Power supply pin. This pin should be externally equipped with a bypass capacitor to minimize ground impedance.	
2 3 5	GND	0	Ground pins. These pins should be connected to system ground with minimum inductance. Ground pattern on the board should be formed as wide as possible. All the ground pins must be connected together with wide ground pattern to minimize impedance difference.	

ORDERING INFORMATION

PART NUMBER	QTY
UPC2763TB-E3-A	3K/Reel

Note:
Embossed Tape, 8 mm wide. Pins 1, 2 and 3 face perforated side of tape.

Данный компонент на территории Российской Федерации

Вы можете приобрести в компании MosChip.

Для оперативного оформления запроса Вам необходимо перейти по данной ссылке:

<http://moschip.ru/get-element>

Вы можете разместить у нас заказ для любого Вашего проекта, будь то серийное производство или разработка единичного прибора.

В нашем ассортименте представлены ведущие мировые производители активных и пассивных электронных компонентов.

Нашей специализацией является поставка электронной компонентной базы двойного назначения, продукции таких производителей как XILINX, Intel (ex.ALTERA), Vicor, Microchip, Texas Instruments, Analog Devices, Mini-Circuits, Amphenol, Glenair.

Сотрудничество с глобальными дистрибьюторами электронных компонентов, предоставляет возможность заказывать и получать с международных складов практически любой перечень компонентов в оптимальные для Вас сроки.

На всех этапах разработки и производства наши партнеры могут получить квалифицированную поддержку опытных инженеров.

Система менеджмента качества компании отвечает требованиям в соответствии с ГОСТ Р ИСО 9001, ГОСТ РВ 0015-002 и ЭС РД 009

Офис по работе с юридическими лицами:

105318, г.Москва, ул.Щербаковская д.3, офис 1107, 1118, ДЦ «Щербаковский»

Телефон: +7 495 668-12-70 (многоканальный)

Факс: +7 495 668-12-70 (доб.304)

E-mail: info@moschip.ru

Skype отдела продаж:

moschip.ru

moschip.ru_4

moschip.ru_6

moschip.ru_9