

Metallized Polypropylene Film EMI Suppression Capacitors – F881, Class Y2, 300 VAC

Overview

The F881 Series is constructed of metallized polypropylene film encapsulated with self-extinguishing resin in a box of material meeting the requirements of UL 94 V-0.

Applications

For worldwide use as electromagnetic interference (EMI) suppression in all "line to earth" applications requiring Y2 safety classification.

Benefits

- Approvals: ENEC, UL, cUL, CQC
- Rated voltage: 300 VAC 50/60 Hz
- Capacitance range: 0.001 – 1.0 μ F
- Lead spacing: 7.5 – 37.5 mm
- Capacitance tolerance: \pm 20%, \pm 10%
- Climatic category: 40/110/56, IEC 60068-1
- Tape & Reel in accordance with IEC 60286-2
- RoHS Compliant and lead-free terminations
- Operating temperature range of -40° C to $+110^{\circ}$ C
- 100% screening factory test at 4,000 VDC and 2,500 VAC

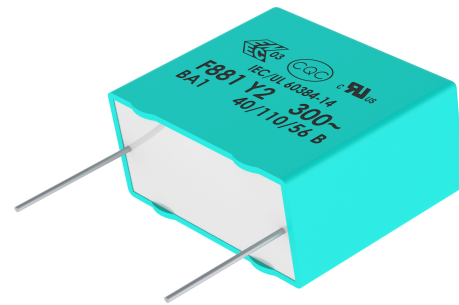

Part Number System

| F | 881 | B | C | 103 | M | 300 | C |
|-----------------|------------------------------|---|---------------------|--|--------------------------------|---------------|----------------------------|
| Capacitor Class | Series | Lead Spacing (mm) | Size Code | Capacitance Code (pF) | Capacitance Tolerance | Voltage (VAC) | Packaging |
| F = Film | Y2, Metallized Polypropylene | K = 7.5 A = 10 B = 15 D = 22.5 F = 27.5 R = 37.5 | See Dimension Table | First two digits represent significant figures. Third digit specifies number of zeros. | K = \pm 10% M = \pm 20% | 300 | See Ordering Options Table |

Ordering Options Table

| Lead Spacing Nominal (mm) | Type of Leads and Packaging | Lead Length (mm) | Lead and Packaging Code |
|---------------------------|--|---------------------------|-------------------------|
| 7.5 | Standard Lead and Packaging Options | | |
| | Bulk (Bag) – Short Leads | 4+2/-0 | C |
| | Bulk (Bag) – Long Leads | 17+0/-1 | A |
| | Tape & Reel (Standard Reel) | H ₀ = 18.5±0.5 | L |
| | Other Lead and Packaging Options | | |
| | Bulk (Bag) – Maximum Length Leads | 20+5/-0 | ALL0L |
| | Ammo Pack | H ₀ = 18.5±0.5 | R |
| 10 | Standard Lead and Packaging Options | | |
| | Bulk (Bag) – Short Leads | 4+2/-0 | C |
| | Bulk (Bag) – Long Leads | 17+0/-1 | A |
| | Tape & Reel (Standard Reel) | H ₀ = 18.5±0.5 | L |
| | Other Lead and Packaging Options | | |
| | Bulk (Bag) – Maximum Length Leads | 20+5/-0 | ALL0L |
| | Ammo Pack | H ₀ = 18.5±0.5 | R |
| | Tape & Reel (Large Reel) | H ₀ = 18.5±0.5 | P |
| 15 | Standard Lead and Packaging Options | | |
| | Bulk (Bag) – Short Leads | 4+2/-0 | C |
| | Bulk (Bag) – Long Leads | 17+0/-1 | A |
| | Tape & Reel (Standard Reel) | H ₀ = 18.5±0.5 | L |
| | Pizza Pack | 4+2/-0 | Z |
| | Other Lead and Packaging Options | | |
| | Bulk (Bag) – Maximum Length Leads | 25+5/-0 | ALR0L |
| | Ammo Pack | H ₀ = 18.5±0.5 | R |
| | Tape & Reel (Large Reel) | H ₀ = 18.5±0.5 | P |
| 22.5 | Standard Lead and Packaging Options | | |
| | Pizza – Long Leads | 17+0/-1 | ZLH0J |
| | Pizza Pack | 4+2/-0 | Z |
| | Other Lead and Packaging Options | | |
| | Tape & Reel (Standard Reel) | H ₀ = 18.5±0.5 | L |
| | Tape & Reel (Large Reel) | H ₀ = 18.5±0.5 | P |
| | Ammo Pack | H ₀ = 18.5±0.5 | R |
| 27.5 | Standard Lead and Packaging Options | | |
| | Pizza – Long Leads | 17+0/-1 | ZLH0J |
| | Pizza Pack | 4+2/-0 | Z |
| 37.5 | Standard Lead and Packaging Options | | |
| | Pizza – Long Leads | 17+0/-1 | ZLH0J |
| | Pizza Pack | 4+2/-0 | Z |

Dimensions – Millimeters



| Size Code | Version | p | | B | | H | | L | | d | |
|-----------|-----------------|---------|-----------|---------|-----------|---------|-----------|---------|-----------|---------|-----------|
| | | Nominal | Tolerance | Nominal | Tolerance | Nominal | Tolerance | Nominal | Tolerance | Nominal | Tolerance |
| KF | | 7.5 | ±0.4 | 3 | +0/-0.5 | 8 | +0/-0.5 | 10 | +0/-0.5 | 0.6 | ±0.05 |
| KG | | 7.5 | ±0.4 | 4 | +0/-0.5 | 8 | +0/-0.5 | 10 | +0/-0.5 | 0.6 | ±0.05 |
| KH | | 7.5 | ±0.4 | 4 | +0/-0.5 | 9 | +0/-0.5 | 10 | +0/-0.5 | 0.6 | ±0.05 |
| KJ | | 7.5 | ±0.4 | 5 | +0/-0.5 | 10.5 | +0/-0.5 | 10 | +0/-0.5 | 0.6 | ±0.05 |
| KM | | 7.5 | ±0.4 | 6 | +0/-0.5 | 12 | +0/-0.5 | 10.5 | +0/-0.5 | 0.6 | ±0.05 |
| AG | | 10.0 | ±0.4 | 4.0 | +0/-0.5 | 9.0 | +0/-0.5 | 13.0 | +0/-0.5 | 0.6 | ±0.05 |
| AK | | 10.0 | ±0.4 | 5.0 | +0/-0.5 | 11.0 | +0/-0.5 | 13.0 | +0/-0.5 | 0.6 | ±0.05 |
| AP | | 10.0 | ±0.4 | 6.0 | +0/-0.5 | 12.0 | +0/-0.5 | 13.0 | +0/-0.5 | 0.6 | ±0.05 |
| AO | | 10.0 | ±0.4 | 7.0 | +0/-0.5 | 17.0 | +0/-0.5 | 13.0 | +0/-0.5 | 0.6 | ±0.05 |
| AL | Low Profile | 10.0 | ±0.4 | 9.5 | +0/-0.5 | 7.5 | +0/-0.5 | 13.0 | +0/-0.5 | 0.6 | ±0.05 |
| AE | Special Version | 10.0 | ±0.4 | 4.0 | +0/-0.5 | 8.0 | +0/-0.5 | 13.0 | +0/-0.5 | 0.6 | ±0.05 |
| BB | | 15.0 | ±0.4 | 4.0 | +0/-0.5 | 10.0 | +0/-0.5 | 18.0 | +0/-0.5 | 0.8 | ±0.05 |
| BC | | 15.0 | ±0.4 | 5.0 | +0/-0.5 | 11.0 | +0/-0.5 | 18.0 | +0/-0.5 | 0.8 | ±0.05 |
| BE | | 15.0 | ±0.4 | 5.5 | +0/-0.5 | 12.5 | +0/-0.5 | 18.0 | +0/-0.5 | 0.8 | ±0.05 |
| BG | | 15.0 | ±0.4 | 6.0 | +0/-0.5 | 12.0 | +0/-0.5 | 18.0 | +0/-0.5 | 0.8 | ±0.05 |
| BI | High Profile | 15.0 | ±0.4 | 6.0 | +0/-0.5 | 17.5 | +0/-0.5 | 18.0 | +0/-0.5 | 0.8 | ±0.05 |
| BK | | 15.0 | ±0.4 | 7.5 | +0/-0.5 | 13.5 | +0/-0.5 | 18.0 | +0/-0.5 | 0.8 | ±0.05 |
| BO | High Profile | 15.0 | ±0.4 | 7.5 | +0/-0.5 | 18.5 | +0/-0.5 | 18.0 | +0/-0.5 | 0.8 | ±0.05 |
| BP | | 15.0 | ±0.4 | 8.5 | +0/-0.5 | 14.5 | +0/-0.5 | 18.0 | +0/-0.5 | 0.8 | ±0.05 |
| BT | | 15.0 | ±0.4 | 9.0 | +0/-0.5 | 12.5 | +0/-0.5 | 18.0 | +0/-0.5 | 0.8 | ±0.05 |
| BS | | 15.0 | ±0.4 | 10.0 | +0/-0.5 | 16.0 | +0/-0.5 | 18.0 | +0/-0.5 | 0.8 | ±0.05 |
| BY | | 15.0 | ±0.4 | 11.0 | +0/-0.5 | 19.0 | +0/-0.5 | 18.0 | +0/-0.5 | 0.8 | ±0.05 |
| BZ | Special Version | 15.0 | ±0.4 | 12.0 | +0/-0.5 | 20.0 | +0/-0.5 | 18.0 | +0/-0.5 | 0.8 | ±0.05 |
| BR | Low Profile | 15.0 | ±0.4 | 13.0 | +0/-0.5 | 12.0 | +0/-0.5 | 18.0 | +0/-0.5 | 0.8 | ±0.05 |
| DB | | 22.5 | ±0.4 | 6.0 | +0/-0.5 | 14.5 | +0/-0.5 | 26.0 | +0/-0.5 | 0.8 | ±0.05 |
| DI | | 22.5 | ±0.4 | 7.0 | +0/-0.5 | 16.0 | +0/-0.5 | 26.0 | +0/-0.5 | 0.8 | ±0.05 |
| DH | | 22.5 | ±0.4 | 8.0 | +0/-0.5 | 16.0 | +0/-0.5 | 26.0 | +0/-0.5 | 0.8 | ±0.05 |
| DJ | | 22.5 | ±0.4 | 8.5 | +0/-0.5 | 17.0 | +0/-0.5 | 26.0 | +0/-0.5 | 0.8 | ±0.05 |

Note: See Ordering Options Table for lead length (LL) options.

Dimensions – Millimeters cont.



| Size Code | Version | p | | B | | H | | L | | d | |
|-----------|--------------|---------|-----------|---------|-----------|---------|-----------|---------|-----------|---------|-----------|
| | | Nominal | Tolerance | Nominal | Tolerance | Nominal | Tolerance | Nominal | Tolerance | Nominal | Tolerance |
| DM | | 22.5 | ±0.4 | 9.0 | +0/-0.5 | 18.5 | +0/-0.5 | 26.0 | +0/-0.5 | 0.8 | ±0.05 |
| DO | | 22.5 | ±0.4 | 10.0 | +0/-0.5 | 18.5 | +0/-0.5 | 26.0 | +0/-0.5 | 0.8 | ±0.05 |
| DP | | 22.5 | ±0.4 | 11.0 | +0/-0.5 | 20.0 | +0/-0.5 | 26.0 | +0/-0.5 | 0.8 | ±0.05 |
| DU | | 22.5 | ±0.4 | 13.0 | +0/-0.5 | 22.0 | +0/-0.5 | 26.0 | +0/-0.5 | 0.8 | ±0.05 |
| DY | | 22.5 | ±0.4 | 15.5 | +0/-0.5 | 24.5 | +0/-0.5 | 26.0 | +0/-0.5 | 0.8 | ±0.05 |
| FB | | 27.5 | ±0.4 | 9.0 | +0/-0.7 | 17.0 | +0/-0.7 | 31.5 | +0/-0.7 | 0.8 | ±0.05 |
| FC | | 27.5 | ±0.4 | 11.0 | +0/-0.7 | 20.0 | +0/-0.7 | 31.5 | +0/-0.7 | 0.8 | ±0.05 |
| FI | | 27.5 | ±0.4 | 13.0 | +0/-0.7 | 25.0 | +0/-0.7 | 31.5 | +0/-0.7 | 0.8 | ±0.05 |
| FN | | 27.5 | ±0.4 | 14.0 | +0/-0.7 | 28.0 | +0/-0.7 | 31.5 | +0/-0.7 | 0.8 | ±0.05 |
| FO | High Profile | 27.5 | ±0.4 | 17.0 | +0/-0.7 | 40.0 | +0/-0.7 | 31.5 | +0/-0.7 | 0.8 | ±0.05 |
| FR | | 27.5 | ±0.4 | 17.5 | +0/-0.7 | 28.0 | +0/-0.7 | 31.5 | +0/-0.7 | 0.8 | ±0.05 |
| FS | | 27.5 | ±0.4 | 19.0 | +0/-0.7 | 29.0 | +0/-0.7 | 31.5 | +0/-0.7 | 0.8 | ±0.05 |
| FY | | 27.5 | ±0.4 | 22.0 | +0/-0.7 | 37.0 | +0/-0.7 | 31.5 | +0/-0.7 | 0.8 | ±0.05 |
| FH | Low Profile | 27.5 | ±0.4 | 21.0 | +0/-0.7 | 12.5 | +0/-0.7 | 31.5 | +0/-0.7 | 0.8 | ±0.05 |
| FQ | Low Profile | 27.5 | ±0.4 | 27.5 | +0/-0.7 | 16.0 | +0/-0.7 | 31.5 | +0/-0.7 | 0.8 | ±0.05 |
| FT | Low Profile | 27.5 | ±0.4 | 31.0 | +0/-0.7 | 19.0 | +0/-0.7 | 31.5 | +0/-0.7 | 0.8 | ±0.05 |
| RB | | 37.5 | ±0.4 | 11.0 | +0/-0.7 | 22.0 | +0/-0.7 | 41.0 | +0/-0.7 | 1.0 | ±0.05 |
| RF | | 37.5 | ±0.4 | 13.0 | +0/-0.7 | 24.0 | +0/-0.7 | 41.0 | +0/-0.7 | 1.0 | ±0.05 |
| RH | | 37.5 | ±0.4 | 15.0 | +0/-0.7 | 26.0 | +0/-0.7 | 41.0 | +0/-0.7 | 1.0 | ±0.05 |
| RC | | 37.5 | ±0.4 | 16.0 | +0/-0.7 | 28.5 | +0/-0.7 | 41.0 | +0/-0.7 | 1.0 | ±0.05 |
| RD | | 37.5 | ±0.4 | 19.0 | +0/-0.7 | 32.0 | +0/-0.7 | 41.0 | +0/-0.7 | 1.0 | ±0.05 |
| RP | | 37.5 | ±0.4 | 21.0 | +0/-0.7 | 38.0 | +0/-0.7 | 41.0 | +0/-0.7 | 1.0 | ±0.05 |
| RO | | 37.5 | ±0.4 | 24.0 | +0/-0.7 | 44.0 | +0/-0.7 | 41.0 | +0/-0.7 | 1.0 | ±0.05 |
| RU | | 37.5 | ±0.4 | 30.0 | +0/-0.7 | 45.0 | +0/-0.7 | 41.0 | +0/-0.7 | 1.0 | ±0.05 |
| RV | Low Profile | 37.5 | ±0.4 | 24.0 | +0/-0.7 | 15.0 | +0/-0.7 | 41.0 | +0/-0.7 | 1.0 | ±0.05 |
| RW | Low Profile | 37.5 | ±0.4 | 24.0 | +0/-0.7 | 19.0 | +0/-0.7 | 41.0 | +0/-0.7 | 1.0 | ±0.05 |

Note: See Ordering Options Table for lead length (LL) options.

Performance Characteristics

| | | | |
|--------------------------------|--|---|-----------------|
| Rated Voltage | 300 VAC 50/60 Hz | | |
| Capacitance Range | 0.001 – 1.0 μ F | | |
| Capacitance Tolerance | \pm 20%, \pm 10% | | |
| Temperature Range | -40°C to +110°C | | |
| Climatic Category | 40/110/56 | | |
| Storage Conditions | Storage time: \leq 24 months from the date marked on the label package Average relative humidity per year \leq 70% RH \leq 85% for 30 days randomly distributed throughout the year Dew is absent Temperature: -40 to 80°C (see "Maximum Humidity in Storage Conditions" graph below) | | |
| Approvals | ENEC, UL, cUL, CQC | | |
| Dissipation Factor | Maximum Values at +23°C | | |
| | | $C \leq 0.1 \mu$ F | $C > 0.1 \mu$ F |
| | 1 kHz | 0.3% | 0.2% |
| Test Voltage Between Terminals | The 100% screening factory test is carried out at 4,000 VDC and 2,500 VAC. The voltage level is selected to meet the requirements in applicable equipment standards. All electrical characteristics are checked after the test. It is not permitted to repeat this test as there is a risk to damage the capacitor. KEMET is not liable in such case for any failures. | | |
| Insulation Resistance | Minimum Values Between Terminals | | |
| | $C \leq 0.33 \mu$ F | $\geq 30,000 \text{ M}\Omega$ | |
| | $C > 0.33 \mu$ F | $\geq 10,000 \text{ M}\Omega \cdot \mu$ F | |
| In DC Applications | Recommended voltage \leq 1,000 VDC | | |

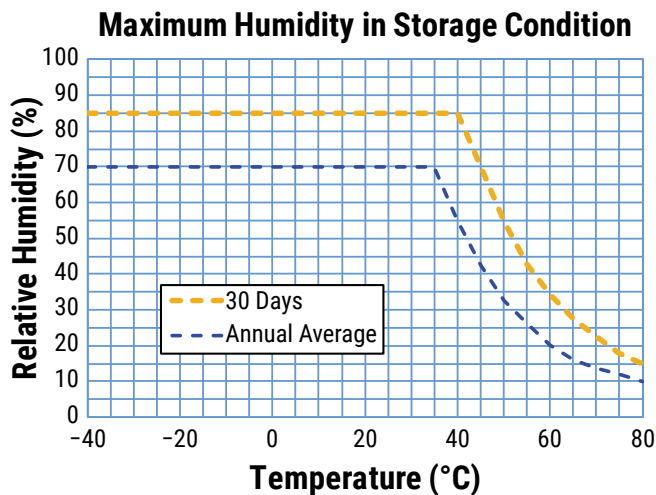

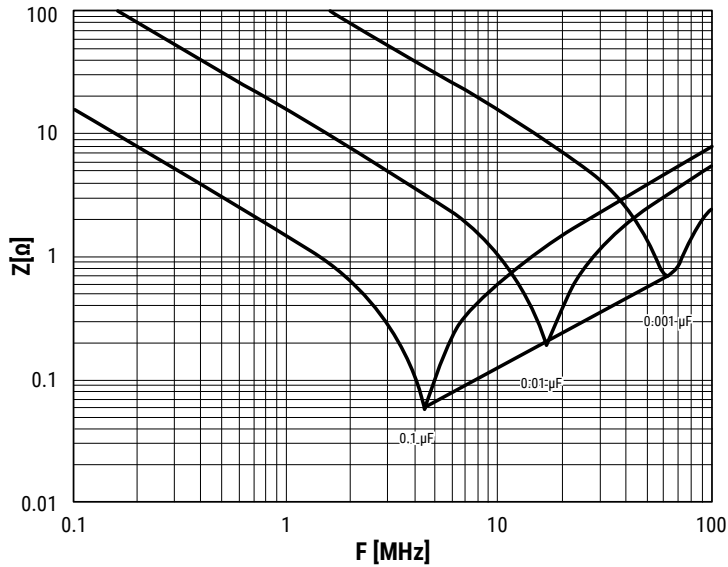

Impedance Graph



Environmental Test Data

| Test | IEC Publication | Procedure |
|------------------------|-------------------------|--|
| Endurance | IEC 60384-14 | 1.7 x V _R VAC 50 Hz, once every hour increase to 1,000 VAC for 0.1 second, 1,000 hours at upper rated temperature |
| Vibration | IEC 60068-2-6 Test Fc | 3 directions at 2 hours each 10 – 55 Hz at 0.75 mm or 98 m/s ² |
| Bump | IEC 60068-2-29 Test Eb | 1,000 bumps at 390 m/s ² |
| Change of Temperature | IEC 60068-2-14 Test Na | Upper and lower rated temperature 5 cycles |
| Active Flammability | IEC 60384-14 | V _R + 20 surge pulses at 5 kV (pulse every 5 seconds) |
| Passive Flammability | IEC 60384-14 | IEC 60384-1, IEC 60695-11-5 Needle-flame test |
| Damp Heat Steady State | IEC 60068-2-78 Test Cab | +40°C and 93% RH, 56 days |

Approvals

| Mark | Specification | File Number |
|---|--------------------------------------|--|
|  | EN/IEC 60384-14 | CA08.00185 |
|  | UL 60384-14 and CAN/CSA-E60384-14 | E97797 |
|  | IEC 60384-14 | CQC12001081968 CQC12001081972 CQC12001081971 CQC12001081970 CQC12001084226 CQC12001088067 |

Environmental Compliance

All new KEMET EMI capacitors are RoHS compliant and Halogen-Free.



Table 1 – Ratings & Part Number Reference

| Capacitance Value (µF) | Size Code | Maximum Dimensions in mm | | | Lead Spacing (p) | dV/dt (V/µs) | Part Number |
|------------------------|-----------|--------------------------|--------|--------|------------------|--------------|--------------------|
| | | B | H | L | | | |
| 0.001 | KF | 3 | 8 | 10 | 7.5 | 800 | F881KF102(1)300(2) |
| 0.0012 | KG | 4 | 8 | 10 | 7.5 | 800 | F881KG122(1)300(2) |
| 0.0015 | KG | 4 | 8 | 10 | 7.5 | 800 | F881KG152(1)300(2) |
| 0.0018 | KH | 4 | 9 | 10 | 7.5 | 800 | F881KH182(1)300(2) |
| 0.0022 | KH | 4 | 9 | 10 | 7.5 | 800 | F881KH222(3)300(2) |
| 0.0025 | KJ | 5 | 10.5 | 10 | 7.5 | 800 | F881KJ252(1)300(2) |
| 0.0027 | KJ | 5 | 10.5 | 10 | 7.5 | 800 | F881KJ272(1)300(2) |
| 0.0033 | KJ | 5 | 10.5 | 10 | 7.5 | 800 | F881KJ332(1)300(2) |
| 0.0039 | KJ | 5 | 10.5 | 10 | 7.5 | 800 | F881KJ392(3)300(2) |
| 0.0039 | KM | 6 | 12 | 10.5 | 7.5 | 800 | F881KM392(1)300(2) |
| 0.0047 | KM | 6 | 12 | 10.5 | 7.5 | 800 | F881KM472(1)300(2) |
| 0.0056 | KM | 6 | 12 | 10.5 | 7.5 | 800 | F881KM562(3)300(2) |
| 0.001 | AE | 4 | 8 | 13 | 10 | 800 | F881AE102(1)300(2) |
| 0.0012 | AE | 4 | 8 | 13 | 10 | 800 | F881AE122(1)300(2) |
| 0.0015 | AE | 4 | 8 | 13 | 10 | 800 | F881AE152(1)300(2) |
| 0.0018 | AE | 4 | 8 | 13 | 10 | 800 | F881AE182(1)300(2) |
| 0.0018 | AL | 9.5 | 7.5 | 13 | 10 | 800 | F881AL182(1)300(2) |
| 0.0022 | AE | 4 | 8 | 13 | 10 | 800 | F881AE222(1)300(2) |
| 0.0022 | AL | 9.5 | 7.5 | 13 | 10 | 800 | F881AL222(1)300(2) |
| 0.0025 | AG | 4 | 9 | 13 | 10 | 800 | F881AG252(1)300(2) |
| 0.0025 | AL | 9.5 | 7.5 | 13 | 10 | 800 | F881AL252(1)300(2) |
| 0.0027 | AG | 4 | 9 | 13 | 10 | 800 | F881AG272(1)300(2) |
| 0.0027 | AL | 9.5 | 7.5 | 13 | 10 | 800 | F881AL272(1)300(2) |
| 0.0033 | AK | 5 | 11 | 13 | 10 | 800 | F881AK332(1)300(2) |
| 0.0033 | AL | 9.5 | 7.5 | 13 | 10 | 800 | F881AL332(1)300(2) |
| 0.0039 | AK | 5 | 11 | 13 | 10 | 800 | F881AK392(1)300(2) |
| 0.0039 | AL | 9.5 | 7.5 | 13 | 10 | 800 | F881AL392(1)300(2) |
| 0.0047 | AK | 5 | 11 | 13 | 10 | 800 | F881AK472(3)300(2) |
| 0.0047 | AL | 9.5 | 7.5 | 13 | 10 | 800 | F881AL472(1)300(2) |
| 0.0056 | AL | 9.5 | 7.5 | 13 | 10 | 800 | F881AL562(1)300(2) |
| 0.0056 | AP | 6 | 12 | 13 | 10 | 800 | F881AP562(1)300(2) |
| 0.0068 | AL | 9.5 | 7.5 | 13 | 10 | 800 | F881AL682(3)300(2) |
| 0.0068 | AP | 6 | 12 | 13 | 10 | 800 | F881AP682(1)300(2) |
| 0.0082 | AO | 7 | 17 | 13 | 10 | 800 | F881AO822(1)300(2) |
| 0.01 | AO | 7 | 17 | 13 | 10 | 800 | F881AO103(1)300(2) |
| 0.0027 | BB | 4 | 10 | 18 | 15 | 600 | F881BB272(1)300(2) |
| 0.0033 | BB | 4 | 10 | 18 | 15 | 600 | F881BB332(1)300(2) |
| 0.0039 | BB | 4 | 10 | 18 | 15 | 600 | F881BB392(1)300(2) |
| 0.0047 | BB | 4 | 10 | 18 | 15 | 600 | F881BB472(1)300(2) |
| 0.0056 | BB | 4 | 10 | 18 | 15 | 600 | F881BB562(1)300(2) |
| 0.0068 | BB | 4 | 10 | 18 | 15 | 600 | F881BB682(1)300(2) |
| 0.0082 | BB | 4 | 10 | 18 | 15 | 600 | F881BB822(1)300(2) |
| 0.01 | BB | 4 | 10 | 18 | 15 | 600 | F881BB103(3)300(2) |
| 0.01 | BC | 5 | 11 | 18 | 15 | 600 | F881BC103(1)300(2) |
| 0.012 | BC | 5 | 11 | 18 | 15 | 600 | F881BC123(1)300(2) |
| 0.015 | BC | 5 | 11 | 18 | 15 | 600 | F881BC153(3)300(2) |
| 0.015 | BE | 5.5 | 12.5 | 18 | 15 | 600 | F881BE153(1)300(2) |
| 0.015 | BT | 9 | 12.5 | 18 | 15 | 600 | F881BT153(1)300(2) |
| 0.018 | BE | 5.5 | 12.5 | 18 | 15 | 600 | F881BE183(1)300(2) |
| 0.018 | BT | 9 | 12.5 | 18 | 15 | 600 | F881BT183(1)300(2) |
| Capacitance Value (µF) | Size Code | B (mm) | H (mm) | L (mm) | Lead Spacing (p) | dV/dt (V/µs) | Part Number |

- (1) M = ±20%, K = ±10%.
- (2) Insert lead and packaging code. See Ordering Options Table for available options.
- (3) M = ±20% (only available tolerance).

Table 1 – Ratings & Part Number Reference cont.

| Capacitance Value (µF) | Size Code | Maximum Dimensions in mm | | | Lead Spacing (p) | dV/dt (V/µs) | Part Number |
|------------------------|-----------|--------------------------|--------|--------|------------------|--------------|--------------------|
| | | B | H | L | | | |
| 0.022 | BG | 6 | 12 | 18 | 15 | 600 | F881BG223(3)300(2) |
| 0.022 | BT | 9 | 12.5 | 18 | 15 | 600 | F881BT223(1)300(2) |
| 0.025 | BI | 6 | 17.5 | 18 | 15 | 600 | F881BI253(3)300(2) |
| 0.025 | BK | 7.5 | 13.5 | 18 | 15 | 600 | F881BK253(1)300(2) |
| 0.025 | BR | 13 | 12 | 18 | 15 | 600 | F881BR253(1)300(2) |
| 0.025 | BT | 9 | 12.5 | 18 | 15 | 600 | F881BT253(1)300(2) |
| 0.027 | BI | 6 | 17.5 | 18 | 15 | 600 | F881BI273(1)300(2) |
| 0.027 | BK | 7.5 | 13.5 | 18 | 15 | 600 | F881BK273(1)300(2) |
| 0.027 | BR | 13 | 12 | 18 | 15 | 600 | F881BR273(1)300(2) |
| 0.027 | BT | 9 | 12.5 | 18 | 15 | 600 | F881BT273(1)300(2) |
| 0.033 | BI | 6 | 17.5 | 18 | 15 | 600 | F881BI333(1)300(2) |
| 0.033 | BO | 7.5 | 18.5 | 18 | 15 | 600 | F881BO333(1)300(2) |
| 0.033 | BR | 13 | 12 | 18 | 15 | 600 | F881BR333(1)300(2) |
| 0.033 | BT | 9 | 12.5 | 18 | 15 | 600 | F881BT333(1)300(2) |
| 0.039 | BI | 6 | 17.5 | 18 | 15 | 600 | F881BI393(3)300(2) |
| 0.039 | BO | 7.5 | 18.5 | 18 | 15 | 600 | F881BO393(1)300(2) |
| 0.039 | BP | 8.5 | 14.5 | 18 | 15 | 600 | F881BP393(1)300(2) |
| 0.039 | BR | 13 | 12 | 18 | 15 | 600 | F881BR393(1)300(2) |
| 0.039 | BT | 9 | 12.5 | 18 | 15 | 600 | F881BT393(3)300(2) |
| 0.047 | BO | 7.5 | 18.5 | 18 | 15 | 600 | F881BO473(1)300(2) |
| 0.047 | BP | 8.5 | 14.5 | 18 | 15 | 600 | F881BP473(3)300(2) |
| 0.047 | BR | 13 | 12 | 18 | 15 | 600 | F881BR473(1)300(2) |
| 0.047 | BS | 10 | 16 | 18 | 15 | 600 | F881BS473(1)300(2) |
| 0.056 | BO | 7.5 | 18.5 | 18 | 15 | 600 | F881BO563(3)300(2) |
| 0.056 | BR | 13 | 12 | 18 | 15 | 600 | F881BR563(3)300(2) |
| 0.056 | BS | 10 | 16 | 18 | 15 | 600 | F881BS563(1)300(2) |
| 0.068 | BY | 11 | 19 | 18 | 15 | 600 | F881BY683(1)300(2) |
| 0.082 | BY | 11 | 19 | 18 | 15 | 600 | F881BY823(3)300(2) |
| 0.082 | BZ | 12 | 20 | 18 | 15 | 600 | F881BZ823(1)300(2) |
| 0.039 | DB | 6 | 14.5 | 26 | 22.5 | 500 | F881DB393(1)300(2) |
| 0.047 | DB | 6 | 14.5 | 26 | 22.5 | 500 | F881DB473(1)300(2) |
| 0.056 | DB | 6 | 14.5 | 26 | 22.5 | 500 | F881DB563(3)300(2) |
| 0.056 | DI | 7 | 16 | 26 | 22.5 | 500 | F881DI563(1)300(2) |
| 0.068 | DI | 7 | 16 | 26 | 22.5 | 500 | F881DI683(1)300(2) |
| 0.082 | DH | 8 | 16 | 26 | 22.5 | 500 | F881DH823(1)300(2) |
| 0.082 | DI | 7 | 16 | 26 | 22.5 | 500 | F881DI823(3)300(2) |
| 0.1 | DH | 8 | 16 | 26 | 22.5 | 500 | F881DH104(3)300(2) |
| 0.1 | DJ | 8.5 | 17 | 26 | 22.5 | 500 | F881DJ104(1)300(2) |
| 0.12 | DJ | 8.5 | 17 | 26 | 22.5 | 500 | F881DJ124(3)300(2) |
| 0.12 | DM | 9 | 18.5 | 26 | 22.5 | 500 | F881DM124(1)300(2) |
| 0.15 | DO | 10 | 18.5 | 26 | 22.5 | 500 | F881DO154(1)300(2) |
| 0.18 | DP | 11 | 20 | 26 | 22.5 | 500 | F881DP184(1)300(2) |
| 0.22 | DP | 11 | 20 | 26 | 22.5 | 500 | F881DP224(3)300(2) |
| 0.22 | DU | 13 | 22 | 26 | 22.5 | 500 | F881DU224(1)300(2) |
| 0.25 | DU | 13 | 22 | 26 | 22.5 | 500 | F881DU254(1)300(2) |
| 0.27 | DU | 13 | 22 | 26 | 22.5 | 500 | F881DU274(1)300(2) |
| 0.33 | DY | 15.5 | 24.5 | 26 | 22.5 | 500 | F881DY334(1)300(2) |
| 0.39 | DY | 15.5 | 24.5 | 26 | 22.5 | 500 | F881DY394(1)300(2) |
| 0.1 | FB | 9 | 17 | 31.5 | 27.5 | 400 | F881FB104(1)300(2) |
| 0.12 | FB | 9 | 17 | 31.5 | 27.5 | 400 | F881FB124(1)300(2) |
| Capacitance Value (µF) | Size Code | B (mm) | H (mm) | L (mm) | Lead Spacing (p) | dV/dt (V/µs) | Part Number |

- (1) M = ±20%, K = ±10%.
- (2) Insert lead and packaging code. See Ordering Options Table for available options.
- (3) M = ±20% (only available tolerance).

Table 1 – Ratings & Part Number Reference cont.

| Capacitance Value (µF) | Size Code | Maximum Dimensions in mm | | | Lead Spacing (p) | dV/dt (V/µs) | Part Number |
|------------------------|-----------|--------------------------|--------|--------|------------------|--------------|--------------------|
| | | B | H | L | | | |
| 0.15 | FB | 9 | 17 | 31.5 | 27.5 | 400 | F881FB154(1)300(2) |
| 0.18 | FC | 11 | 20 | 31.5 | 27.5 | 400 | F881FC184(1)300(2) |
| 0.22 | FC | 11 | 20 | 31.5 | 27.5 | 400 | F881FC224(1)300(2) |
| 0.22 | FH | 21 | 12.5 | 31.5 | 27.5 | 400 | F881FH224(1)300(2) |
| 0.25 | FC | 11 | 20 | 31.5 | 27.5 | 400 | F881FC254(3)300(2) |
| 0.25 | FH | 21 | 12.5 | 31.5 | 27.5 | 400 | F881FH254(1)300(2) |
| 0.27 | FC | 11 | 20 | 31.5 | 27.5 | 400 | F881FC274(3)300(2) |
| 0.27 | FH | 21 | 12.5 | 31.5 | 27.5 | 400 | F881FH274(1)300(2) |
| 0.27 | FI | 13 | 25 | 31.5 | 27.5 | 400 | F881FI274(1)300(2) |
| 0.33 | FH | 21 | 12.5 | 31.5 | 27.5 | 400 | F881FH334(3)300(2) |
| 0.33 | FI | 13 | 25 | 31.5 | 27.5 | 400 | F881FI334(1)300(2) |
| 0.39 | FI | 13 | 25 | 31.5 | 27.5 | 400 | F881FI394(1)300(2) |
| 0.39 | FQ | 27.5 | 16 | 31.5 | 27.5 | 400 | F881FQ394(1)300(2) |
| 0.47 | FR | 17.5 | 28 | 31.5 | 27.5 | 400 | F881FR474(1)300(2) |
| 0.47 | FQ | 27.5 | 16 | 31.5 | 27.5 | 400 | F881FQ474(1)300(2) |
| 0.56 | FN | 14 | 28 | 31.5 | 27.5 | 400 | F881FN564(1)300(2) |
| 0.56 | FR | 17.5 | 28 | 31.5 | 27.5 | 400 | F881FR564(1)300(2) |
| 0.56 | FT | 31 | 19 | 31.5 | 27.5 | 400 | F881FT564(1)300(2) |
| 0.68 | FO | 17 | 40 | 31.5 | 27.5 | 400 | F881FO684(1)300(2) |
| 0.68 | FR | 17.5 | 28 | 31.5 | 27.5 | 400 | F881FR684(1)300(2) |
| 0.68 | FT | 31 | 19 | 31.5 | 27.5 | 400 | F881FT684(1)300(2) |
| 0.82 | FO | 17 | 40 | 31.5 | 27.5 | 400 | F881FO824(1)300(2) |
| 0.82 | FT | 31 | 19 | 31.5 | 27.5 | 400 | F881FT824(3)300(2) |
| 0.82 | FY | 22 | 37 | 31.5 | 27.5 | 400 | F881FY824(1)300(2) |
| 1 | FY | 22 | 37 | 31.5 | 27.5 | 400 | F881FY105(1)300(2) |
| 0.33 | RB | 11 | 22 | 41 | 37.5 | 300 | F881RB334(1)300(2) |
| 0.39 | RB | 11 | 22 | 41 | 37.5 | 300 | F881RB394(1)300(2) |
| 0.47 | RF | 13 | 24 | 41 | 37.5 | 300 | F881RF474(1)300(2) |
| 0.47 | RV | 24 | 15 | 41 | 37.5 | 300 | F881RV474(1)300(2) |
| 0.56 | RH | 15 | 26 | 41 | 37.5 | 300 | F881RH564(1)300(2) |
| 0.56 | RV | 24 | 15 | 41 | 37.5 | 300 | F881RV564(1)300(2) |
| 0.68 | RH | 15 | 26 | 41 | 37.5 | 300 | F881RH684(1)300(2) |
| 0.68 | RW | 24 | 19 | 41 | 37.5 | 300 | F881RW684(1)300(2) |
| 0.82 | RH | 15 | 26 | 41 | 37.5 | 300 | F881RH824(1)300(2) |
| 0.82 | RW | 24 | 19 | 41 | 37.5 | 300 | F881RW824(1)300(2) |
| 1 | RD | 19 | 32 | 41 | 37.5 | 300 | F881RD105(1)300(2) |
| 1 | RW | 24 | 19 | 41 | 37.5 | 300 | F881RW105(1)300(2) |
| Capacitance Value (µF) | Size Code | B (mm) | H (mm) | L (mm) | Lead Spacing (p) | dV/dt (V/µs) | Part Number |

- (1) M = ±20%, K = ±10%.
 (2) Insert lead and packaging code. See Ordering Options Table for available options.
 (3) M = ±20% (only available tolerance).

Soldering Process

The implementation of the RoHS directive has resulted in the selection of SnAgCu (SAC) alloys or SnCu alloys as primary solder. This has increased the liquidus temperature from that of 183°C for SnPb eutectic alloy to 217 – 221°C for the new alloys. As a result, the heat stress to the components, even in wave soldering, has increased considerably due to higher pre-heat and wave temperatures. Polypropylene capacitors are especially sensitive to heat (the melting point of polypropylene is 160 – 170°C). Wave soldering can be destructive, especially for mechanically small polypropylene capacitors (with lead spacing of 5 mm to 15 mm), and great care has to be taken during soldering. The recommended solder profiles from KEMET should be used. Please consult KEMET with any questions. In general, the wave soldering curve from IEC Publication 61760-1 Edition 2 serves as a solid guideline for successful soldering. Please see Figure 1.

Reflow soldering is not recommended for through-hole film capacitors. Exposing capacitors to a soldering profile in excess of the above the recommended limits may result to degradation or permanent damage to the capacitors.

Do not place the polypropylene capacitor through an adhesive curing oven to cure resin for surface mount components. Insert through-hole parts after the curing of surface mount parts. Consult KEMET to discuss the actual temperature profile in the oven, if through-hole components must pass through the adhesive curing process. A maximum two soldering cycles is recommended. Please allow time for the capacitor surface temperature to return to a normal temperature before the second soldering cycle.

Manual Soldering Recommendations

Following is the recommendation for manual soldering with a soldering iron.

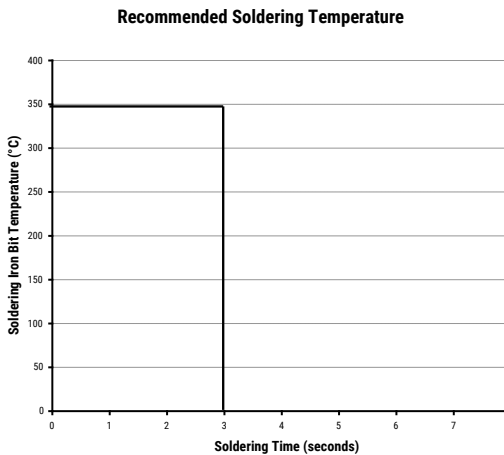

The soldering iron tip temperature should be set at 350°C (+10°C maximum), with the soldering duration not to exceed more than 3 seconds.

Wave Soldering Recommendations

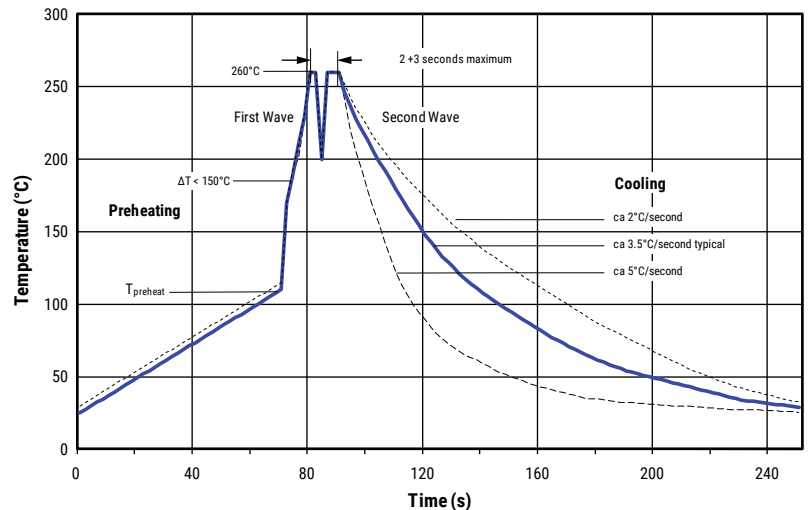

Soldering Process cont.

Wave Soldering Recommendations cont.

1. The table indicates the maximum set-up temperature of the soldering process
 Figure 1

| Dielectric Film Material | Maximum Preheat Temperature | | Maximum Peak Soldering Temperature | |
|--------------------------|-----------------------------|-------------------------|------------------------------------|-------------------------|
| | Capacitor Pitch ≤ 15 mm | Capacitor Pitch > 15 mm | Capacitor Pitch ≤ 15 mm | Capacitor Pitch > 15 mm |
| Polyester | 130°C | 130°C | 270°C | 270°C |
| Polypropylene | 110°C | 130°C | 260°C | 270°C |
| Paper | 130°C | 140°C | 270°C | 270°C |
| Polyphenylene Sulphide | 150°C | 160°C | 270°C | 270°C |

2. The maximum temperature measured inside the capacitor:

Set the temperature so that inside the element the maximum temperature is below the limit:

| Dielectric Film Material | Maximum temperature measured inside the element |
|--------------------------|---|
| Polyester | 160°C |
| Polypropylene | 110°C |
| Paper | 160°C |
| Polyphenylene Sulphide | 160°C |



Temperature monitored inside the capacitor.

Selective Soldering Recommendations

Selective dip soldering is a variation of reflow soldering. In this method, the printed circuit board with through-hole components to be soldered is preheated and transported over the solder bath as in normal flow soldering without touching the solder. When the board is over the bath, it is stopped and pre-designed solder pots are lifted from the bath with molten solder only at the places of the selected components, and pressed against the lower surface of the board to solder the components.

The temperature profile for selective soldering is similar to the double wave flow soldering outlined in this document, **however, instead of two baths, there is only one bath with a time from 3 to 10 seconds.** In selective soldering, the risk of overheating is greater than in double wave flow soldering, and great care must be taken so that the parts are not overheated.

Construction

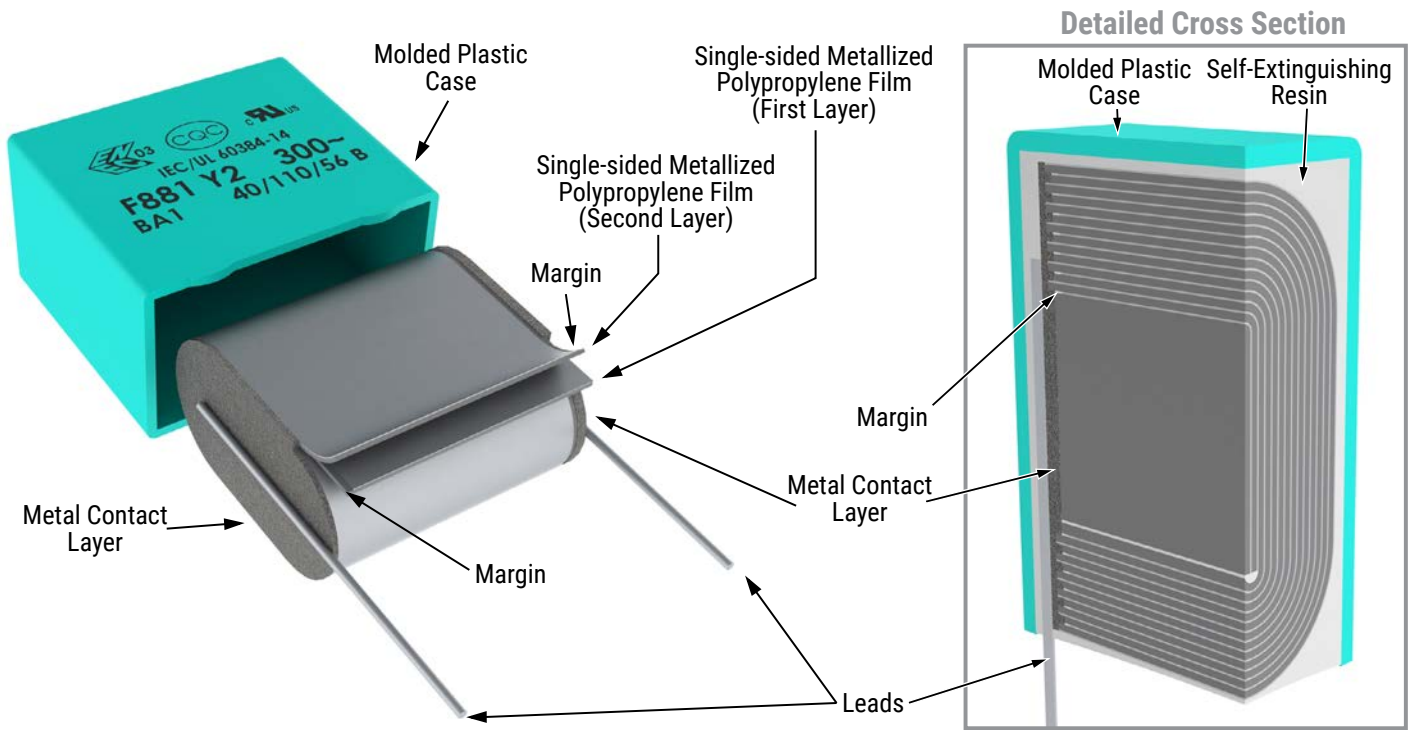

Winding Scheme

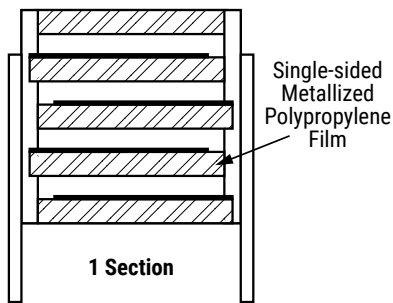

Marking

Pitch = 7.5 mm

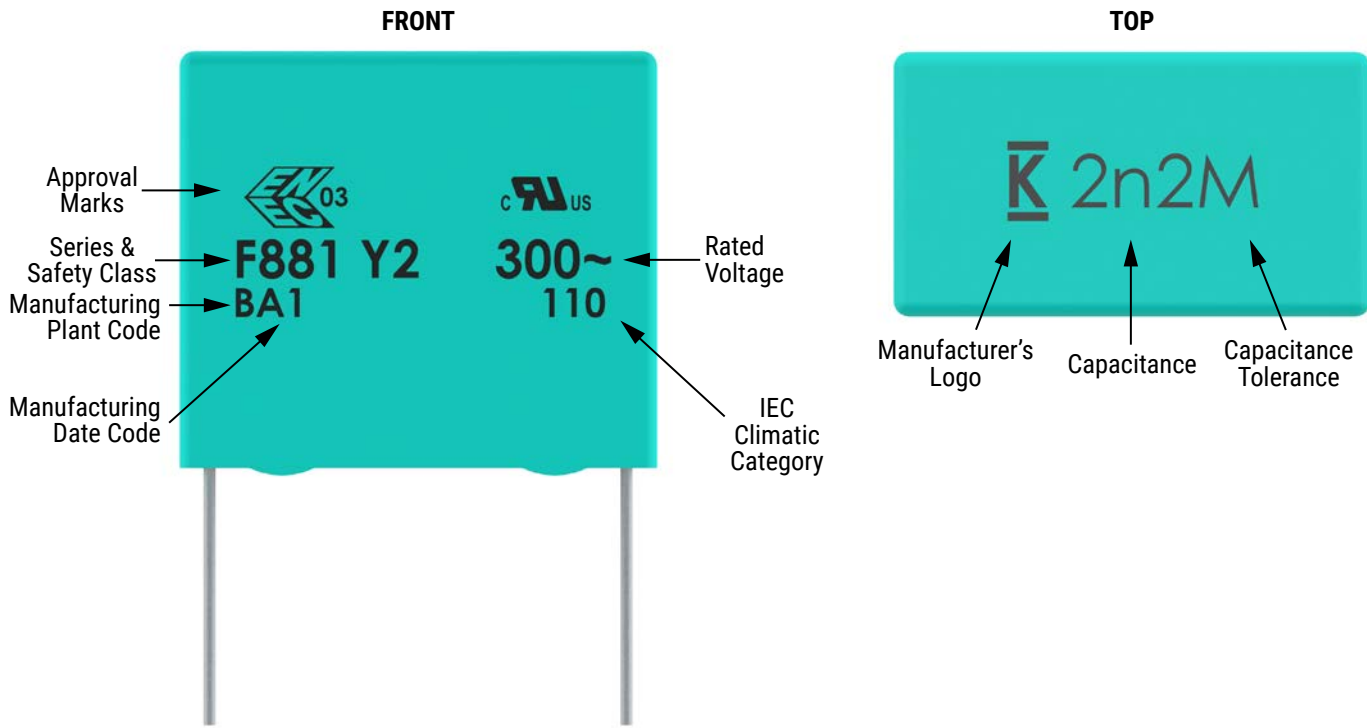

Pitch ≥ 10 mm

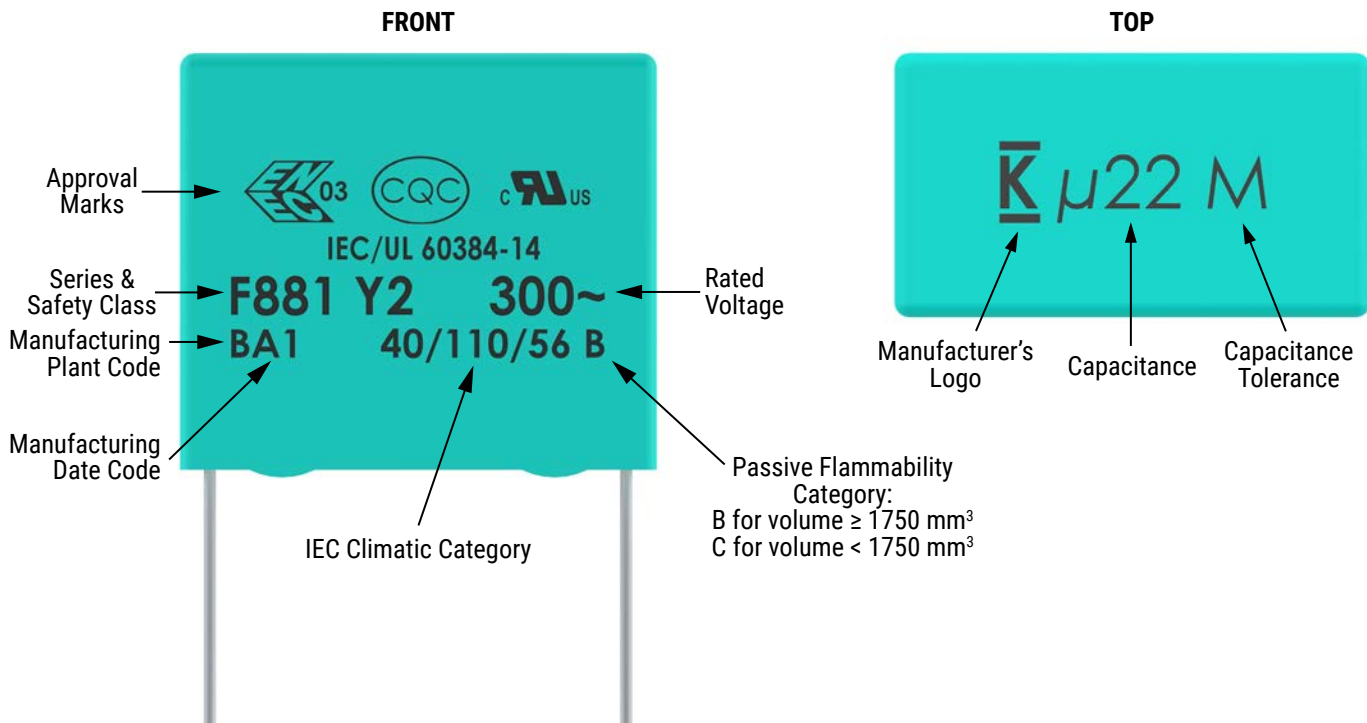

Manufacturing Date Code (IEC-60062)

| Y = Year, Z = Month | | | |
|---------------------|------|-----------|------|
| Year | Code | Month | Code |
| 2010 | A | January | 1 |
| 2011 | B | February | 2 |
| 2012 | C | March | 3 |
| 2013 | D | April | 4 |
| 2014 | E | May | 5 |
| 2015 | F | June | 6 |
| 2016 | H | July | 7 |
| 2017 | J | August | 8 |
| 2018 | K | September | 9 |
| 2019 | L | October | 0 |
| 2020 | M | November | N |
| 2021 | N | December | D |
| 2022 | P | | |
| 2023 | R | | |
| 2024 | S | | |
| 2025 | T | | |
| 2026 | U | | |
| 2027 | V | | |
| 2028 | W | | |
| 2029 | X | | |
| 2030 | A | | |

Packaging Quantities

| Size Code | Lead Spacing | Thickness (mm) | Height (mm) | Length (mm) | Bulk Short Leads | Bulk Long Leads | Standard Reel Ø 355 mm | Large Reel Ø 500 mm | Ammo | Pizza |
|-----------|--------------|----------------|-------------|-------------|------------------|-----------------|---------------------------|------------------------|-------|-------|
| KE | 7.5 | 2.5 | 6 | 10 | 2,000 | 2,500 | 2,500 | | 3,500 | |
| KF | | 3 | 8 | 10 | 1,500 | 1,750 | 2,100 | | 2,800 | |
| KG | | 4 | 8 | 10 | 2,000 | 1,500 | 1,500 | | 2,100 | |
| KJ | | 5 | 10.5 | 10 | 1,500 | 1,000 | 1,200 | | 1,600 | |
| KM | | 6 | 12 | 10.5 | 1,000 | 800 | 1,000 | | 1,350 | |
| KH | | 4 | 9 | 10 | 2,000 | 1,500 | 1,500 | | 2,100 | |
| AN | 10 | 3.5 | 9 | 13 | 2,000 | 2,200 | 850 | 1,700 | 1,150 | |
| AG | | 4 | 9 | 13 | 2,000 | 2,200 | 750 | 1,500 | 1,000 | |
| AK | | 5 | 11 | 13 | 1,300 | 2,000 | 600 | 1,250 | 800 | |
| AP | | 6 | 12 | 13 | 1,000 | 1,800 | 500 | 1,000 | 680 | |
| AO | | 7 | 17 | 13 | 600 | 700 | 450 | 900 | 580 | |
| AL | | 9.5 | 7.5 | 13 | 1,000 | 1,500 | 300 | 600 | 430 | |
| AE | | 4 | 8 | 13 | 2,000 | 2,200 | 750 | 1,500 | 1,000 | |
| BB | 15 | 4 | 10 | 18 | 2,500 | 1,500 | 750 | 1,500 | 1,000 | 1,411 |
| BC | | 5 | 11 | 18 | 1,000 | 1,250 | 600 | 1,250 | 800 | 1,139 |
| BE | | 5.5 | 12.5 | 18 | 800 | 1,000 | 550 | 1,100 | 750 | 1,020 |
| BG | | 6 | 12 | 18 | 1,750 | 1,000 | 500 | 1,000 | 680 | 935 |
| BK | | 7.5 | 13.5 | 18 | 1,000 | 800 | 350 | 800 | 500 | 748 |
| BI | | 6 | 17.5 | 18 | 1,000 | 800 | 500 | 1,000 | 680 | 935 |
| BP | | 8.5 | 14.5 | 18 | 1,000 | 650 | 300 | 700 | 440 | 663 |
| BT | | 9 | 12.5 | 18 | 1,000 | 700 | 270 | 650 | 410 | 629 |
| BO | | 7.5 | 18.5 | 18 | 900 | 500 | 350 | 800 | 500 | 748 |
| BS | | 10 | 16 | 18 | 750 | 550 | 300 | 600 | 380 | 561 |
| BR | | 13 | 12 | 18 | 750 | 520 | 200 | 480 | 280 | 425 |
| BY | | 11 | 19 | 18 | 450 | 400 | 250 | 500 | 340 | 510 |
| BA | | 8.5 | 12.5 | 18 | 1,000 | 650 | 300 | 700 | 440 | 663 |
| BZ | | 12 | 20 | 18 | 350 | 300 | 220 | 450 | 330 | 459 |
| DB | 22.5 | 6 | 14.5 | 26 | 805 | 450 | 300 | 700 | 464 | 660 |
| DI | | 7 | 16 | 26 | 700 | 450 | 250 | 550 | 380 | 564 |
| DH | | 8.0 | 16.0 | 26 | 520 | 300 | 240 | 500 | 330 | 492 |
| DJ | | 8.5 | 17 | 26 | 450 | 350 | 250 | 450 | 280 | 468 |
| DM | | 9 | 18.5 | 26 | 400 | 225 | 200 | 400 | 300 | 444 |
| DO | | 10 | 18.5 | 26 | 360 | 350 | 160 | 350 | 235 | 396 |
| DP | | 11 | 20 | 26 | 300 | 200 | 190 | 350 | 217 | 360 |
| DU | | 13 | 22 | 26 | 230 | 150 | 150 | 300 | 200 | 300 |
| DY | | 15.5 | 24.5 | 26 | 150 | 100 | 120 | 250 | 170 | 252 |

Packaging Quantities cont.

| Size Code | Lead Spacing | Thickness (mm) | Height (mm) | Length (mm) | Bulk Short Leads | Bulk Long Leads | Standard Reel ∅ 355 mm | Large Reel ∅ 500 mm | Ammo | Pizza |
|-----------|--------------|----------------|-------------|-------------|------------------|-----------------|---------------------------|------------------------|------|-------|
| FB | 27.5 | 9.0 | 17.0 | 31.5 | | | | | | 370 |
| FC | | 11.0 | 20.0 | 31.5 | | | | | | 300 |
| FI | | 13.0 | 25.0 | 31.5 | | | | | | 250 |
| FN | | 14.0 | 28.0 | 31.5 | | | | | | 230 |
| FO | | 17.0 | 40.0 | 31.5 | | | | | | 190 |
| FR | | 17.5 | 28.0 | 31.5 | | | | | | 190 |
| FS | | 19.0 | 29.0 | 31.5 | | | | | | 170 |
| FY | | 22.0 | 37.0 | 31.5 | | | | | | 150 |
| FH | | 21.0 | 12.5 | 31.5 | | | | | | 150 |
| FQ | | 27.5 | 16.0 | 31.5 | | | | | | 120 |
| FT | | 31.0 | 19.0 | 31.5 | | | | | | 100 |
| RB | 37.5 | 11.0 | 22.0 | 41.0 | | | | | | 210 |
| RF | | 13.0 | 24.0 | 41.0 | | | | | | 175 |
| RH | | 15.0 | 26.0 | 41.0 | | | | | | 154 |
| RC | | 16.0 | 28.5 | 41.0 | | | | | | 140 |
| RD | | 19.0 | 32.0 | 41.0 | | | | | | 119 |
| RP | | 21.0 | 38.0 | 41.0 | | | | | | 105 |
| RO | | 24.0 | 44.0 | 41.0 | | | | | | 91 |
| RU | | 30.0 | 45.0 | 41.0 | | | | | | 77 |
| RV | | 24.0 | 15.0 | 41.0 | | | | | | 91 |
| RW | | 24.0 | 19.0 | 41.0 | | | | | | 91 |

Lead Taping & Packaging (IEC 60286-2)

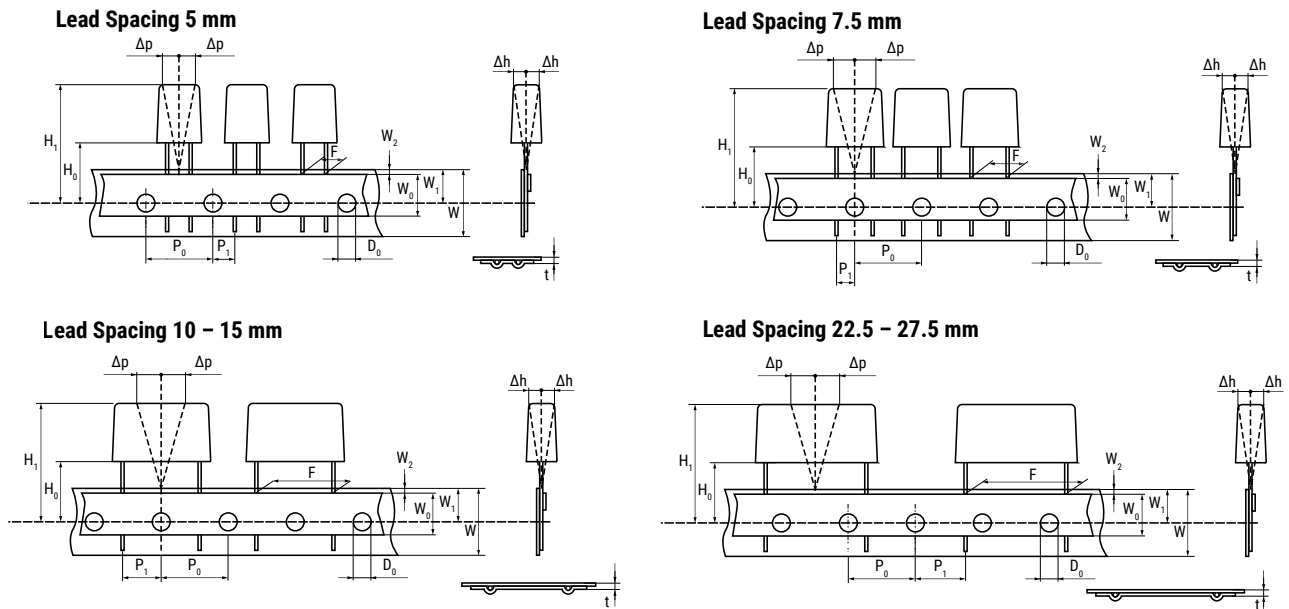

Taping Specification

| Dimensions in mm | | | | | | | | | Standard IEC 60286-2 |
|---------------------------|---------------------|----------------------|----------------------|----------------------|----------------------|----------------------|----------------------|----------------------|-------------------------|
| Lead Spacing | +0.6/-0.1 | F | 5 | 7.5 | 10 | 15 | 22.5 | 27.5 | F |
| Carrier Tape Width | +1/-0.5 | W | 18 | 18 | 18 | 18 | 18 | 18 | 18 ^{+1/-0.5} |
| Hold-down Tape Width | Minimum | W_0 | 6 | 6 | 9 | 10 | 10 | 10 | |
| Position of Sprocket Hole | ±0.5 | W_1 | 9 | 9 | 9 | 9 | 9 | 9 | 9 ^{+0.75/-0.5} |
| Distance Between Tapes | Maximum | W_2 | 3 | 3 | 3 | 3 | 3 | 3 | 3 |
| Sprocket Hole Diameter | ±0.2 | D_0 | 4 | 4 | 4 | 4 | 4 | 4 | 4 |
| Feed Hole Lead Spacing | ±0.2 ⁽¹⁾ | P_0 ⁽³⁾ | 12.7 | 12.7 | 12.7 | 12.7 | 12.7 | 12.7 | 12.7 |
| Distance Lead – Feed Hole | ±0.7 | P_1 | 3.85 | 3.75 | 7.7 | 5.2 | 7.8 | 5.3 | P ¹ |
| Deviation Tape – Plane | Maximum | Δp | 1.3 | 1.3 | 1.3 | 1.3 | 1.3 | 1.3 | 1.3 |
| Lateral Deviation | ±2 | Δh | 2 | 2 | 2 | 2 | 2 | 2 | 2 |
| Total Thickness | ±0.2 | t | 0.7 | 0.7 | 0.7 | 0.7 | 0.9 ^{MAX} | 0.9 ^{MAX} | 0.9 ^{MAX} |
| Sprocket Hole/Cap Body | ±0.5 | H_0 ⁽²⁾ | 18.5 ^{±0.5} | 18.5 ^{±0.5} | 18.5 ^{±0.5} | 18.5 ^{±0.5} | 18.5 ^{±0.5} | 18.5 ^{±0.5} | 18 ^{+2/-0} |

(1) Maximum cumulative feed hole error, 1 mm per 20 parts.

(2) 16.5 mm available on request.

(3) 15 mm available on request ($F \geq 10$ mm).

Lead Taping & Packaging (IEC 60286-2) cont.

Ammo Specifications

| Series | Dimensions (mm) | | |
|------------------------|-----------------|-----|----|
| | H | W | T |
| R4x, R4x+R, R7x, RSB | 360 | 340 | 59 |
| F5A, F5B, F5D | | | |
| F6xx, F8xx | | | |
| PHExxx, PMExxx, PMRxxx | 330 | 330 | 50 |



Reel Specifications

| Series | Dimensions (mm) | | |
|------------------------|-----------------|----|-----------------|
| | D | H | W |
| R4x, R4x+R, R7x, RSB | 355 500 | 30 | 55 |
| F5A, F5B, F5D | | 25 | (maximum) |
| F6xx, F8xx | | | |
| PHExxx, PMExxx, PMRxxx | 360 500 | 30 | 46 (maximum) |



KEMET Electronics Corporation Sales Offices

For a complete list of our global sales offices, please visit www.kemet.com/sales.

Disclaimer

All product specifications, statements, information and data (collectively, the "Information") in this datasheet are subject to change. The customer is responsible for checking and verifying the extent to which the Information contained in this publication is applicable to an order at the time the order is placed. All Information given herein is believed to be accurate and reliable, but it is presented without guarantee, warranty, or responsibility of any kind, expressed or implied.

Statements of suitability for certain applications are based on KEMET Electronics Corporation's ("KEMET") knowledge of typical operating conditions for such applications, but are not intended to constitute – and KEMET specifically disclaims – any warranty concerning suitability for a specific customer application or use. The Information is intended for use only by customers who have the requisite experience and capability to determine the correct products for their application. Any technical advice inferred from this Information or otherwise provided by KEMET with reference to the use of KEMET's products is given gratis, and KEMET assumes no obligation or liability for the advice given or results obtained.

Although KEMET designs and manufactures its products to the most stringent quality and safety standards, given the current state of the art, isolated component failures may still occur. Accordingly, customer applications which require a high degree of reliability or safety should employ suitable designs or other safeguards (such as installation of protective circuitry or redundancies) in order to ensure that the failure of an electrical component does not result in a risk of personal injury or property damage.

Although all product-related warnings, cautions and notes must be observed, the customer should not assume that all safety measures are indicated or that other measures may not be required.

KEMET is a registered trademark of KEMET Electronics Corporation.

Данный компонент на территории Российской Федерации

Вы можете приобрести в компании MosChip.

Для оперативного оформления запроса Вам необходимо перейти по данной ссылке:

<http://moschip.ru/get-element>

Вы можете разместить у нас заказ для любого Вашего проекта, будь то серийное производство или разработка единичного прибора.

В нашем ассортименте представлены ведущие мировые производители активных и пассивных электронных компонентов.

Нашей специализацией является поставка электронной компонентной базы двойного назначения, продукции таких производителей как XILINX, Intel (ex.ALTERA), Vicor, Microchip, Texas Instruments, Analog Devices, Mini-Circuits, Amphenol, Glenair.

Сотрудничество с глобальными дистрибьюторами электронных компонентов, предоставляет возможность заказывать и получать с международных складов практически любой перечень компонентов в оптимальные для Вас сроки.

На всех этапах разработки и производства наши партнеры могут получить квалифицированную поддержку опытных инженеров.

Система менеджмента качества компании отвечает требованиям в соответствии с ГОСТ Р ИСО 9001, ГОСТ РВ 0015-002 и ЭС РД 009

Офис по работе с юридическими лицами:

105318, г.Москва, ул.Щербаковская д.3, офис 1107, 1118, ДЦ «Щербаковский»

Телефон: +7 495 668-12-70 (многоканальный)

Факс: +7 495 668-12-70 (доб.304)

E-mail: info@moschip.ru

Skype отдела продаж:

moschip.ru

moschip.ru_4

moschip.ru_6

moschip.ru_9