

## Main

Range of product	OsiSense XCC
Encoder type	Multiturn absolute encoder
Device short name	XCC
Product specific application	-
Diameter	3.54 in (90 mm)
Shaft diameter	0.47 in (12 mm)
Shaft type	Solid shaft
Resolution	4096 turns/8192 points
Electrical connection	1 male connector M23 radial 12 pins
Output stage	Type SB
Type of output stage	SSI 25-bit binary
[Us] rated supply voltage	11...30 V DC
Enclosure material	Zamak

## Complementary

Shaft tolerance	G6
Residual ripple	500 mV
Maximum revolution speed	6000 rpm
Shaft moment of inertia	0.05 lb.in <sup>2</sup> (150 g.cm <sup>2</sup> )
Torque value	0.09 lbf.in (0.01 N.m)
Maximum load	10 daN axial 20 daN radial
Output frequency	100...500 kHz
Current consumption	0...100 mA no-load
Protection type	Reverse polarity protection Short-circuit protection
Physical interface	RS422
Output level	High level: 2 V minimum 20 mA
Surge withstand	1 kV level 2 IEC 61000-4-5
Base material	Aluminium
Shaft material	Stainless steel
Type of ball bearings	6000ZZ
Product weight	4.06 lb(US) (1.84 kg)

## Environment

marking	CE
ambient air temperature for operation	-4...185 °F (-20...85 °C)
ambient air temperature for storage	-22...185 °F (-30...85 °C)
IP degree of protection	IP66 IEC 60529
vibration resistance	10 gn (10...2000 Hz) IEC 60068-2-6
shock resistance	30 gn (11 ms) IEC 60068-2-27
resistance to electrostatic discharge	4 kV contact discharge level 3 IEC 61000-4-2 8 kV air discharge level 3 IEC 61000-4-2
resistance to electromagnetic fields	9.14 V/yd (10 V/m) level 3 IEC 61000-4-3
resistance to fast transients	1 kV signal ports level 3 IEC 61000-4-4 2 kV power ports level 3 IEC 61000-4-4

## Offer Sustainability

Compliant - since 0701 - Schneider Electric declaration of conformity    Compliant - since 0701 - Schneider Electric declaration of conformity

Reference not containing SVHC above the threshold    Reference not containing SVHC above the threshold

WARNING: This product can expose you to chemicals including:    WARNING: This product can expose you to chemicals including:

Diisononyl phthalate (DINP), which is known to the State of California to cause cancer, and    Diisononyl phthalate (DINP), which is known to the State of California to cause cancer, and

Di-isodecyl phthalate (DIDP), which is known to the State of California to cause birth defects or other reproductive harm.    Di-isodecyl phthalate (DIDP), which is known to the State of California to cause birth defects or other reproductive harm.

For more information go to [www.p65warnings.ca.gov](http://www.p65warnings.ca.gov)    For more information go to [www.p65warnings.ca.gov](http://www.p65warnings.ca.gov)

**Contractual warranty**

Warranty period    18 months

**Dimensions**

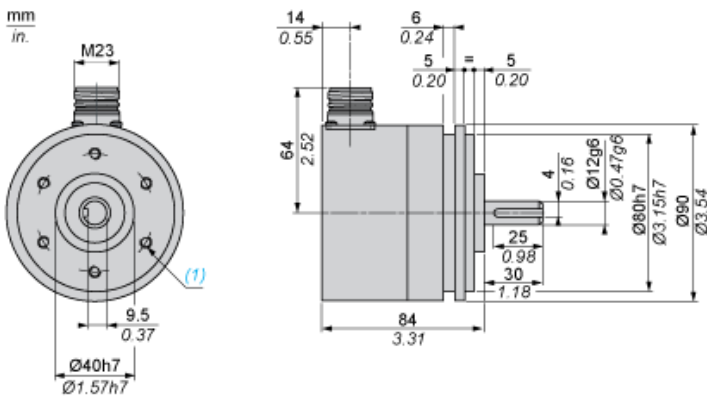



(1) 6 holes M6 x 1 at 120° on 60 PCD, depth: 12 mm maximum

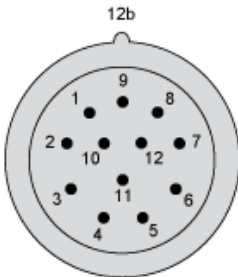

**Wiring Diagram**

**M23, 12-pin Connector, Anticlockwise Connections**

Male Connector on Encoder



Pin number	1	2	3	4	5	6	7	8	9	10	11	12
Signal Supply	0 V	Data +	Clk +	R	Direction  (1)	Reset to zero	R	+ V	R	Data -	Clk -	R

(1)  : Clockwise direction  
 : Anticlockwise direction

R = Reserved (do not connect)

**Technical Description**

**RS 422 Data Output**

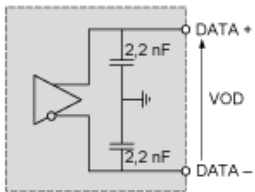

(1)

(1)  $I_{data} = 20 \text{ mA}$   $|VOD| > 2 \text{ V}$

### Isolated Clock Input

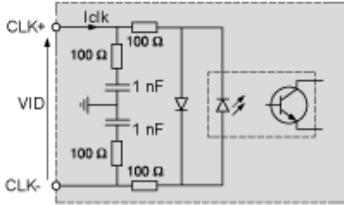

VID maximum: 5 V

Iclk maximum: 15 mA

### DIRECTION Input

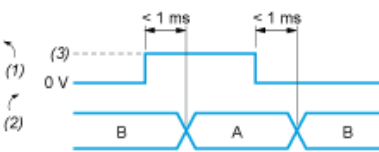

A : Anticlockwise

B : Clockwise

(1) DIRECTION input

(2) DIRECTION of counting

(3) V supply

### Input Stage - Reset to Zero

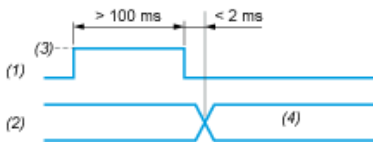

(1) Reset input

(2) Position

(3) V supply

(4) Position=0 (Reset to zero)

## Данный компонент на территории Российской Федерации

### Вы можете приобрести в компании MosChip.

Для оперативного оформления запроса Вам необходимо перейти по данной ссылке:

<http://moschip.ru/get-element>

Вы можете разместить у нас заказ для любого Вашего проекта, будь то серийное производство или разработка единичного прибора.

В нашем ассортименте представлены ведущие мировые производители активных и пассивных электронных компонентов.

Нашей специализацией является поставка электронной компонентной базы двойного назначения, продукции таких производителей как XILINX, Intel (ex.ALTERA), Vicor, Microchip, Texas Instruments, Analog Devices, Mini-Circuits, Amphenol, Glenair.

Сотрудничество с глобальными дистрибьюторами электронных компонентов, предоставляет возможность заказывать и получать с международных складов практически любой перечень компонентов в оптимальные для Вас сроки.

На всех этапах разработки и производства наши партнеры могут получить квалифицированную поддержку опытных инженеров.

Система менеджмента качества компании отвечает требованиям в соответствии с ГОСТ Р ИСО 9001, ГОСТ РВ 0015-002 и ЭС РД 009

### Офис по работе с юридическими лицами:

105318, г.Москва, ул.Щербаковская д.3, офис 1107, 1118, ДЦ «Щербаковский»

Телефон: +7 495 668-12-70 (многоканальный)

Факс: +7 495 668-12-70 (доб.304)

E-mail: [info@moschip.ru](mailto:info@moschip.ru)

Skype отдела продаж:

moschip.ru

moschip.ru\_4

moschip.ru\_6

moschip.ru\_9