

DUAL AUDIO POWER AMPLIFIER

■ GENERAL DESCRIPTION

The NJW1105 is a dual audio amplifier which supplies 2.4W (1.2W/channel) to 8Ω loads at 5V. Its features are wide operating voltage range from 4V to 12V and low consumption output by Bi-MOS technology.

The NJW1105 is suitable for speaker amplifier required high output power, such as personal computers, camcorders, and others. It includes thermally protected and mute on/off circuit.

■ FEATURES

- Operating Voltage ($V^+ = 4V \sim 12V$)
- Output Power (1.2W/ch at $V^+ = 5V, R_L = 8\Omega$)
- Supply Current (35mA MAX.)
- Supply Current on Mute (3.5mA MAX.)
- Bi-MOS Technology
- Package Outline DIP16, SDMP30, SSOP20-F1

■ PACKAGE OUTLINE

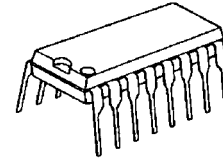

NJW1105D

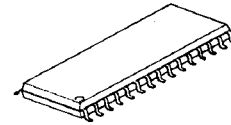

NJW1105M

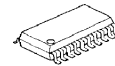

NJW1105VF1

■ BLOCK DIAGRAM

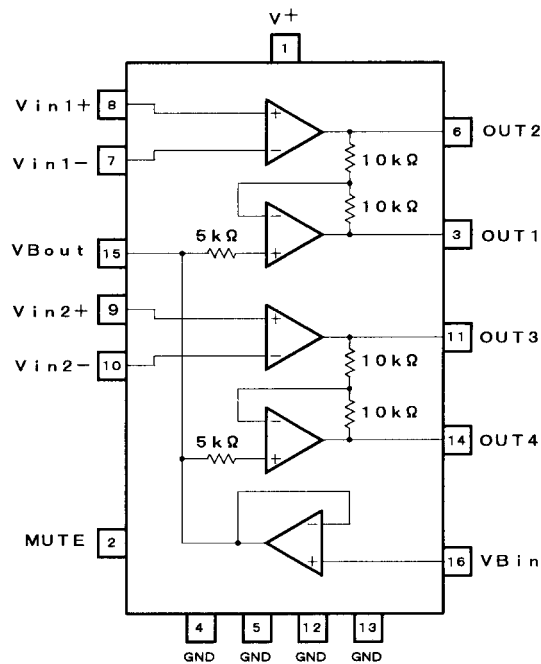

(Package DIP16)

NJW1105

■ ABSOLUTE MAXIMUM RATINGS

(Ta=25°C)

PARAMETER	SYMBOL	RATINGS	UNIT
Supply Voltage	V ⁺	15	V
Operating Current	I _o	1	A
Mute Terminal Current	I _M	1.0	mA
Power Dissipation	P _D	(SSOP20) 0.75 (DIP16) 1.9 (SDMP30) 1.8 (note1)	W
Operating Temperature Range	T _{opr}	-40~+85	°C
Storage Temperature Range	T _{stg}	-40~+150	°C

(note 1) At on PC board.

■ ELECTRICAL CHARACTERISTICS

(V⁺=5.0V, Ta=25°C)

PARAMETER	SYMBOL	TEST CONDITION	MIN.	TYP.	MAX.	UNIT
[ALL]						
Operating Supply Voltage Range	V ⁺		4	5	12	V
Mute OFF Current Dissipation	I _{cc1}	V _M =4.2V, V _{IN} =2.5V	-	20	35	mA
Mute ON Current Dissipation	I _{cc2}	V _M =0V, V _{IN} =2.5V	-	2	3.5	mA
[POWER AMPLIFIER]						
Output Offset Voltage	ΔV _O	R _L =8Ω	-50	-	50	mV
Input Bias Current	I _B		-	-	300	nA
Output Power	P _{O1}	THD=10%, f=1kHz, R _L =8Ω	-	1.2	-	W
	P _{O2}	THD=10%, f=1kHz, R _L =8Ω, V ⁺ =7V	-	2.5	-	W
Total Harmonic Distortion	THD	R _L =8Ω, P _O =800mW, f=1kHz	-	0.35	-	%
Power Supply Rejection Ratio	PSRR	f=1kHz	-	45	-	dB
Voltage Gain	A _V	AMP2, AMP3, R _L =2kΩ, V _{IN} =2.5V	35	50	-	dB
[BUFFER AMPLIFIER]						
Input Output Potential Difference	V _{BO}		-30	0	30	mV
Input Voltage Range	V _{BI}		1.5	2.5	3.5	V
Output Voltage Range	ΔV _{BO}	I _L =-5mA, I _L =+5mA	-	-	-50	mV
[MUTING]						
Mute OFF Voltage	V _{MH}		3.5	4.2	-	V
Mute ON Voltage	V _{ML}		-	0.8	1.0	V
Mute Sink Current	I _M	V _M =5V	70	100	130	μA

■ PIN CONFIGURATION

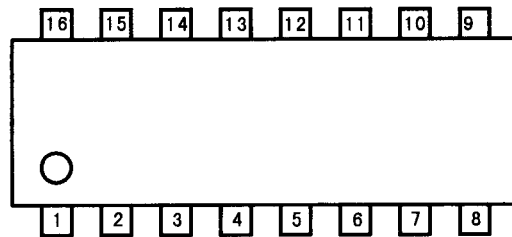

DIP16

- | | |
|-------------------|--------------|
| 1. V ⁺ | 9. Vin2 (+) |
| 2. MUTE | 10. Vin2 (-) |
| 3. OUT1 | 11. OUT3 |
| 4. GND | 12. GND |
| 5. GND | 13. GND |
| 6. OUT2 | 14. OUT4 |
| 7. Vin1 (-) | 15. VBout |
| 8. Vin1 (+) | 16. VBin |

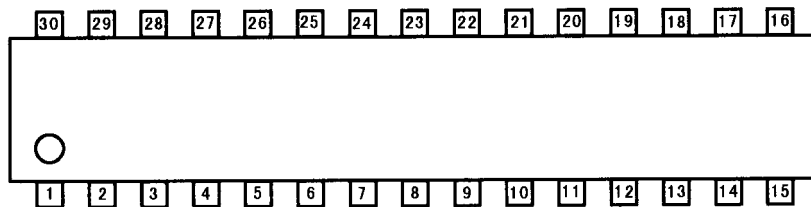

SDMP30

- | | |
|-------------------|--------------|
| 1. GND | 16. GND |
| 2. GND | 17. GND |
| 3. OUT4 | 18. OUT2 |
| 4. NC | 19. NC |
| 5. NC | 20. NC |
| 6. VBout | 21. Vin1 (-) |
| 7. VBin | 22. Vin1 (+) |
| 8. NC | 23. NC |
| 9. V ⁺ | 24. Vin2 (+) |
| 10. MUTE | 25. Vin2 (-) |
| 11. NC | 26. NC |
| 12. NC | 27. NC |
| 13. OUT1 | 28. OUT3 |
| 14. GND | 29. GND |
| 15. GND | 30. GND |

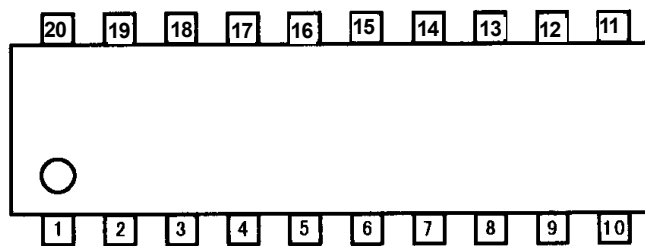

SSOP-20

- | | |
|-------------------|-------------|
| 1. V ⁺ | 11. Vin2(+) |
| 2. V ⁺ | 12. Vin2(-) |
| 3. MUTE | 13. OUT3 |
| 4. OUT1 | 14. GND |
| 5. GND | 15. GND |
| 6. GND | 16. OUT4 |
| 7. OUT2 | 17. NC |
| 8. Vin1(-) | 18. NC |
| 9. Vin1(+) | 19. VBout |
| 10. NC | 20. VBin |

■ TERMINAL EXPLANATION

PIN NO.			PIN NAME	FUNCTION	INSIDE EQUIVALENT CIRCUIT
SSOP-20	DIP-16	SDMP-30			
5 6 14 15	4 5 12 13	1 2 14 15 16 17 29 30	GND	Recommend expanding the island in order to heat radiation properties.	
16	14	3	OUT4	Output terminal of AMP4. OUT4 signal is opposite phase against OUT3.	
10 17 18	-	4 5 8 11 12 19 20 23 26 27	NC	Non-connection terminal. Recommend connecting to GND.	

NJW1105

■ TERMINAL EXPLANATION

PIN NO.			PIN NAME	FUNCTION	INSIDE EQUIVALENT CIRCUIT
SSOP-20	DIP-16	SDMP-30			
19	15	6	VBout	An buffer amplifier output.	
20	16	7	VBin	An buffer amplifier input.	
1 2	1	9	Vcc	Supply Voltage.	
3	2	10	MUTE	A mute input. Pull down by 50kΩ (TYP) resistor.	

■ TERMINAL EXPLANATION

PIN NO.			PIN NAME	FUNCTION	INSIDE EQUIVALENT CIRCUIT
SSOP-20	DIP-16	SDMP-30			
4	3	13	OUT1	Output terminal of AMP.1. OUT1 signal is opposite phase against OUT2.	
7	6	18	OUT2	Output terminal of AMP.2.	
8	7	21	Vin1(-)	Inverting input terminal of AMP.2.	
9	8	22	Vin1(+)	Non-inverting input terminal of AMP.2.	

NJW1105

■ TERMINAL EXPLANATION

PIN NO.			PIN NAME	FUNCTION	INSIDE EQUIVALENT CIRCUIT
SSOP-20	DIP-16	SDMP-30			
11	9	24	Vin2(+)	Inverting input terminal of AMP3.	
12	10	25	Vin2(-)	Non-inverting input terminal of AMP3.	
13	11	28	OUT3	Output terminal of AMP3.	

APPLICATION CIRCUIT

(1) BTL

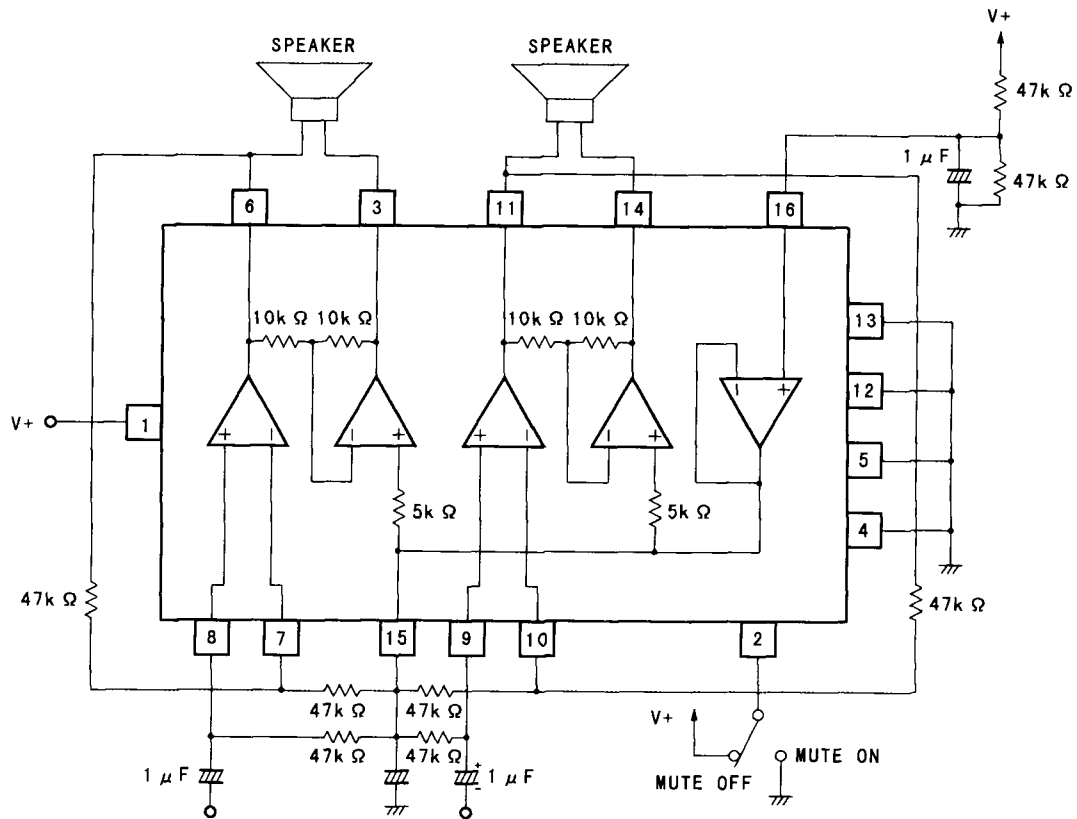

(The number in “()” indicates a pin number of SDMP.)

■ TYPICAL CHARACTERISTICS

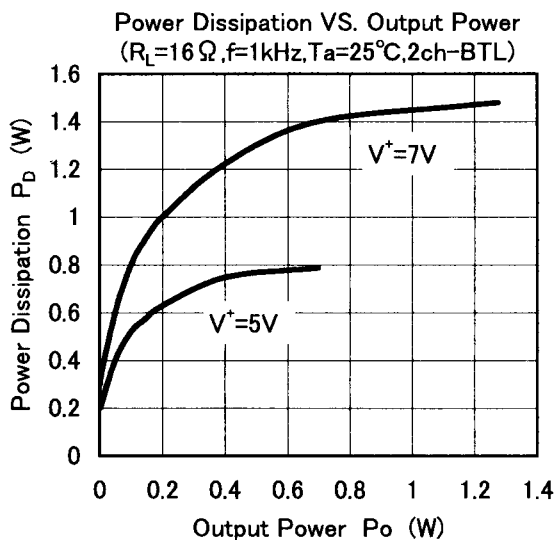
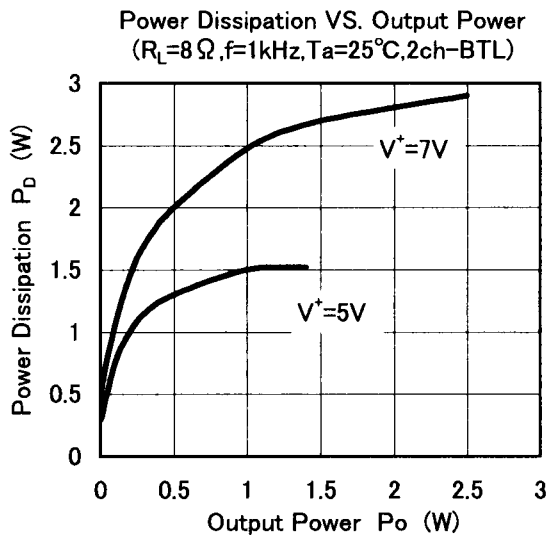
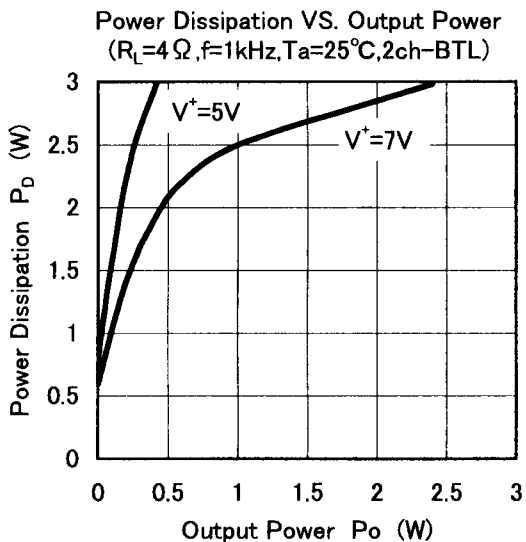
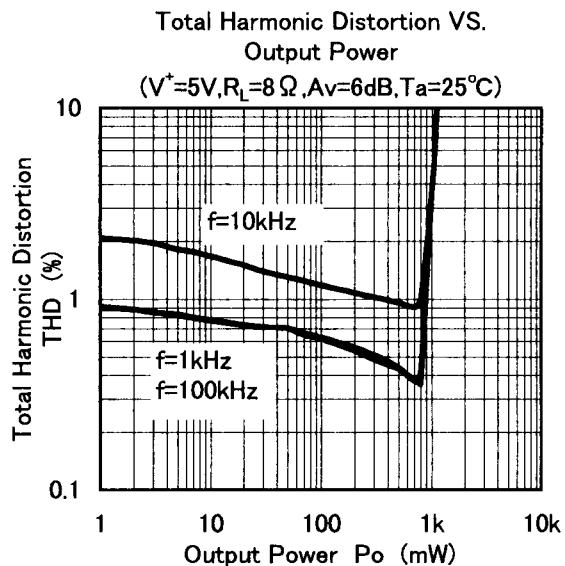
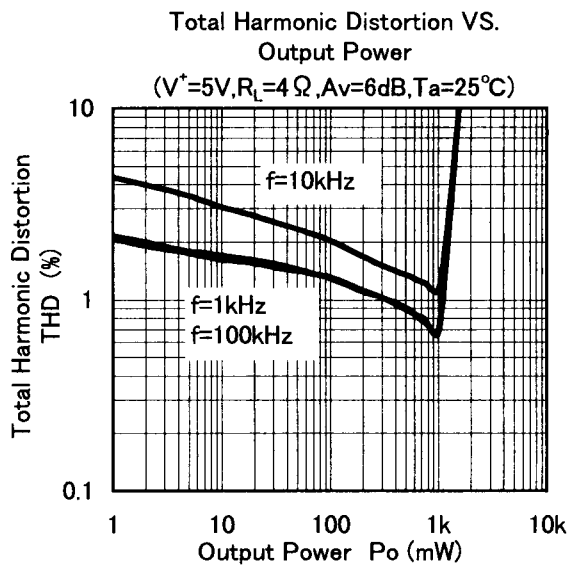

■ TYPICAL CHARACTERISTICS

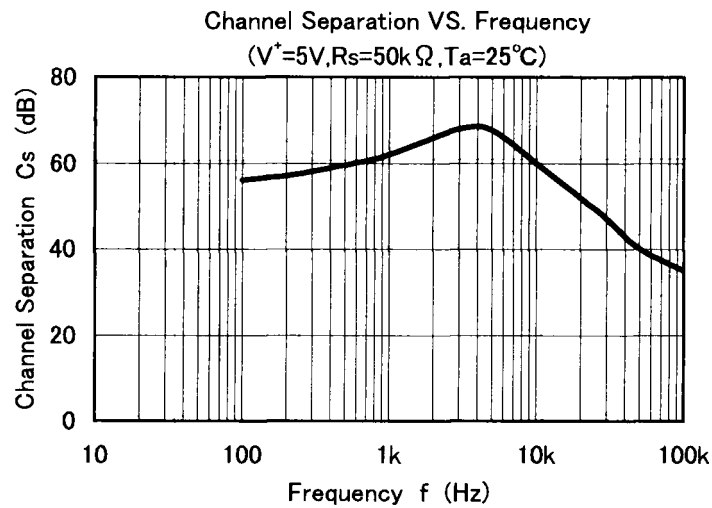
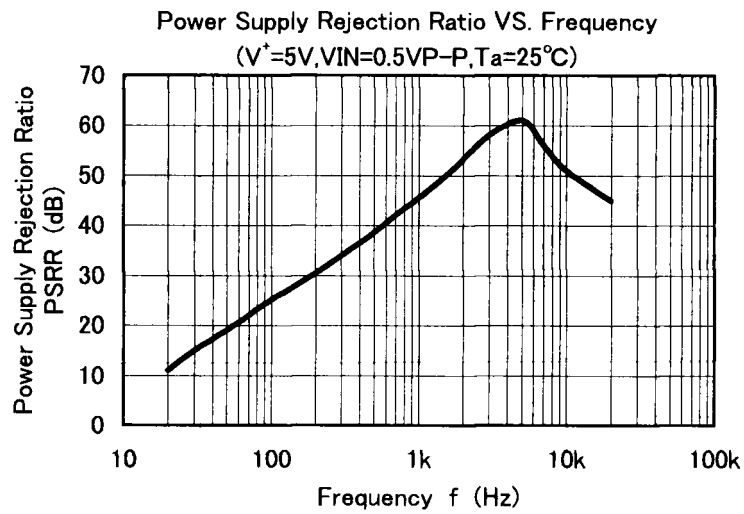

[CAUTION]

The specifications on this databook are only given for information, without any guarantee as regards either mistakes or omissions. The application circuits in this databook are described only to show representative usages of the product and not intended for the guarantee or permission of any right including the industrial rights.

Данный компонент на территории Российской Федерации

Вы можете приобрести в компании MosChip.

Для оперативного оформления запроса Вам необходимо перейти по данной ссылке:

<http://moschip.ru/get-element>

Вы можете разместить у нас заказ для любого Вашего проекта, будь то серийное производство или разработка единичного прибора.

В нашем ассортименте представлены ведущие мировые производители активных и пассивных электронных компонентов.

Нашей специализацией является поставка электронной компонентной базы двойного назначения, продукции таких производителей как XILINX, Intel (ex.ALTERA), Vicor, Microchip, Texas Instruments, Analog Devices, Mini-Circuits, Amphenol, Glenair.

Сотрудничество с глобальными дистрибьюторами электронных компонентов, предоставляет возможность заказывать и получать с международных складов практически любой перечень компонентов в оптимальные для Вас сроки.

На всех этапах разработки и производства наши партнеры могут получить квалифицированную поддержку опытных инженеров.

Система менеджмента качества компании отвечает требованиям в соответствии с ГОСТ Р ИСО 9001, ГОСТ РВ 0015-002 и ЭС РД 009

Офис по работе с юридическими лицами:

105318, г.Москва, ул.Щербаковская д.3, офис 1107, 1118, ДЦ «Щербаковский»

Телефон: +7 495 668-12-70 (многоканальный)

Факс: +7 495 668-12-70 (доб.304)

E-mail: info@moschip.ru

Skype отдела продаж:

moschip.ru

moschip.ru_4

moschip.ru_6

moschip.ru_9