



FEATURES

- High efficiency:
 - 93% @ 12Vin, 5V/20A out
 - 92% @ 12Vin, 3.3V/20A out
 - 90% @ 12Vin, 2.5V/20A out
 - 89% @ 12Vin, 1.8V/20A out
 - 83% @ 12Vin, 1.2V/20A out
 - 79% @ 10Vin, 0.69V/20A out
- Small size and low profile: 33.02x 13.46x 8.5mm (1.3"x 0.53"x 0.33")
- Surface mount packaging
- Standard footprint
- Voltage and resistor-based trim
- Pre-bias startup
- Output voltage tracking
- No minimum load required
- Output voltage programmable from 0.69Vdc to 5 Vdc via external resistor
- Fixed frequency operation and ability to Synchronize with external clock
- Input UVLO, output OCP
- Remote on/off
- ISO 9001, TL 9000, ISO 14001, QS9000, OHSAS18001 certified manufacturing facility
UL/cUL 60950-1 (US & Canada)

Delphi DCL, Non-Isolated Point of Load DC/DC Power Modules: 4.5~14Vin, 0.69V-5V/20Aout

The Delphi Series DCL, 4.5-14V input, single output, non-isolated Point of Load DC/DC converters are the latest offering from a world leader in power systems technology and manufacturing -- Delta Electronics, Inc. The DCL series provides a programmable output voltage from 0.69 V to 5 V using an external resistor and has flexible and programmable tracking features to enable a variety of startup voltages as well as tracking between power modules. This product family is available in surface mount and provides up to 20A of output current in an industry standard footprint. With creative design technology and optimization of component placement, these converters possess outstanding electrical and thermal performance, as well as extremely high reliability under highly stressful operating conditions.

OPTIONS

- Negative/Positive on/off logic
- Vo Tracking feature

APPLICATIONS

- Telecom / DataCom
- Distributed power architectures
- Servers and workstations
- LAN / WAN applications
- Data processing applications

TECHNICAL SPECIFICATIONS

PARAMETER	NOTES and CONDITIONS	DCL12S0A0S20NFA			
		Min.	Typ.	Max.	Units
ABSOLUTE MAXIMUM RATINGS					
Input Voltage (Continuous)		-0.3		15	V
Sequencing Voltage		-0.3		V _{in} max	V
Operating Ambient Temperature		-40		85	°C
Storage Temperature		-55		125	°C
INPUT CHARACTERISTICS					
Operating Input Voltage	$V_o \leq V_{in} - 0.6$	4.5		14	V
Input Under-Voltage Lockout			4.45		V
Turn-On Voltage Threshold			4.2		V
Lockout Hysteresis Voltage			0.25		V
Maximum Input Current	V _{in} =4.5V to 14V, I _o =I _o max			20	A
No-Load Input Current (I _o = 0, module enabled)	V _{in} = 10V, V _{o,set} = 0.69 Vdc		60		mA
	V _{in} = 12V, V _{o,set} = 3.3 Vdc		74		mA
Off Converter Input Current (VIN = 12.0Vdc, module disabled)			3		mA
Inrush Transient				1	A2S
Input Reflected Ripple Current, peak-to-peak	(5Hz to 20MHz, 1μH source impedance; V _{in} = 0 to 14V, I _o =I _o max ;		43		mAp-p
Input Ripple Rejection(120Hz)			45		dB
OUTPUT CHARACTERISTICS					
Output Voltage Set Point	with 0.5% tolerance for external resistor used to set output voltage)	-1.5	V _{o,set}	+1.5	%V _{o,set}
Output Voltage Adjustable Range	(selected by an external resistor)	0.69		5.0	V
Output Voltage Regulation					
Line(V _{IN} =V _{IN} , min to V _{IN} , max)	For V _o >=2.5V			0.4	%V _{o,set}
	For V _o <2.5V			10	mV
Load(I _o =I _o , min to I _o , max)	For V _o >=2.5V			10	mV
	For V _o <2.5V			5	mV
Temperature(T _{ref} =T _A , min to T _A , max)	For V _o >=2.5V			0.5	%V _{o,set}
	For V _o <2.5V			5	mV
Total Output Voltage Range	Over sample load, line and temperature	-2.5		+2.5	%V _{o,set}
Output Voltage Ripple and Noise	5Hz to 20MHz bandwidth				
Peak-to-Peak	V _{in} = V _{in} nominal, I _o =I _o ,min to I _o ,max, C _o = 1μF+10uF ceramic,			80	mV
RMS	V _{in} = V _{in} nominal, I _o =I _o ,min to I _o ,max, C _o = 1μF+10uF ceramic,			28	mV
Output Current Range		0		20	A
Output Voltage Over-shoot at Start-up				5	% V _{o,set}
Output DC Current-Limit Inception			140		% I _o
Output Short-Circuit Current (Hiccup Mode)	I _o ,s/c		2.6		Adc
DYNAMIC CHARACTERISTICS					
Dynamic Load Response	10μF T _{an} & 1μF Ceramic load cap, 2.5A/μs				
Positive Step Change in Output Current	50% I _o , max to 100% I _o , max		380		mV
Negative Step Change in Output Current	100% I _o , max to 50% I _o , max		380		mV
Settling Time to 10% of Peak Deviation			30		μs
Turn-On Transient	I _o =I _o ,max				
Start-Up Time, From On/Off Control	Time for V _{on} /off to V _o =10% of V _{o,set}		2		ms
Start-Up Time, From Input	Time for V _{in} =V _{in} ,min to V _o =10% of V _{o,set}		2		ms
Output Voltage Rise Time	Time for V _o to rise from 10% to 90% of V _{o,set}		5		ms
Output Capacitive Load	Full load; ESR ≥ 0.15mΩ	94		1000	μF
EFFICIENCY					
V _o =5.0V	V _{in} =12V, 100% Load		93		%
V _o =3.3V	V _{in} =12V, 100% Load		92		%
V _o =2.5V	V _{in} =12V, 100% Load		90		%
V _o =1.8V	V _{in} =12V, 100% Load		89		%
V _o =1.2V	V _{in} =12V, 100% Load		83		%
V _o =0.69V	V _{in} =10V, 100% Load		79		%
FEATURE CHARACTERISTICS					
Switching Frequency			500		kHz
Synchronization Frequency Range		520		600	kHz
ON/OFF Control, (Negative logic)					
Logic Low Voltage	Module On, V _{on} /off	0		1	V
Logic High Voltage	Module Off, V _{on} /off	2		V _{in} ,max	V
Logic Low Current	Module On, I _{on} /off			10	μA
Logic High Current	Module Off, I _{on} /off			1	mA
ON/OFF Control, (Positive Logic)					
Logic High Voltage	Module On, V _{on} /off	V _{in} -1		V _{in} ,max	V
Logic Low Voltage	Module Off, V _{on} /off			3.5	V
Logic Low Current	Module On, I _{on} /off			3	mA
Logic High Current	Module Off, I _{on} /off			25	μA
Tracking Slew Rate Capability				0.5	V/msec
Tracking Delay Time	Delay from V _{in} ,min to application of tracking voltage	10			ms
Tracking Accuracy	Power-up 0.5V/mS			100	mV
	Power-down 0.5V/mS			150	mV
GENERAL SPECIFICATIONS					
MTBF	I _o =80% of I _o , max; T _a =25°C		32.51		M hours
Weight			5.5		grams

(T_A = 25°C, airflow rate = 300 LFM, V_{in} = 4.5Vdc and 14.0Vdc, nominal V_{out} unless otherwise noted.)

ELECTRICAL CHARACTERISTICS CURVES

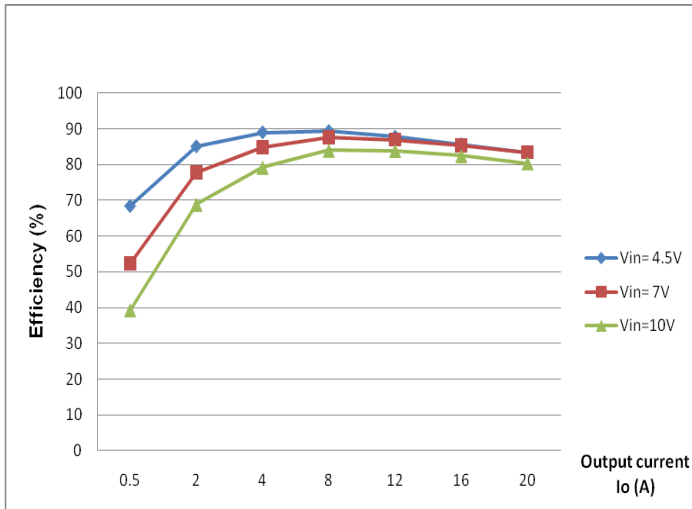

Figure 1: Converter efficiency vs. output current ($V_{out}= 0.69V$)

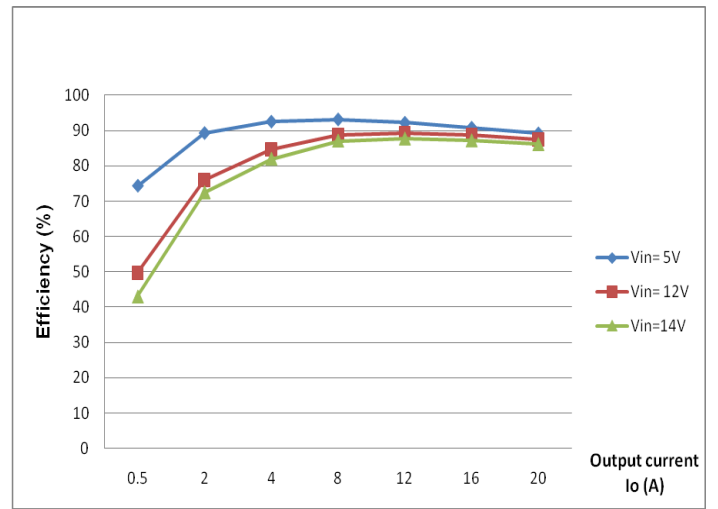

Figure 2: Converter efficiency vs. output current (1.2V out)

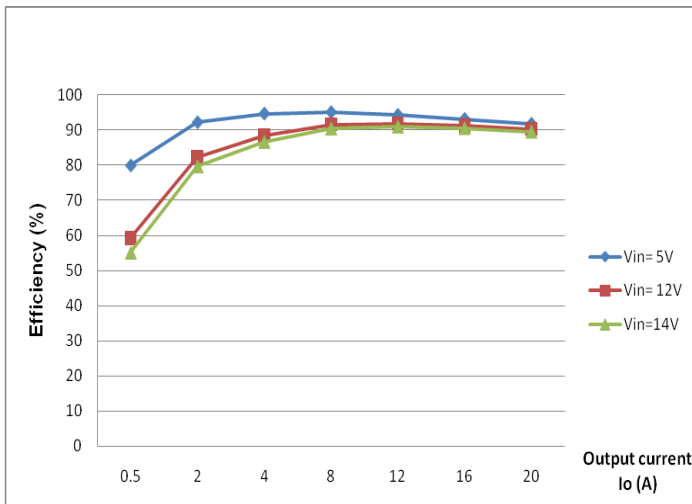

Figure 3: Converter efficiency vs. output current (1.8V out)

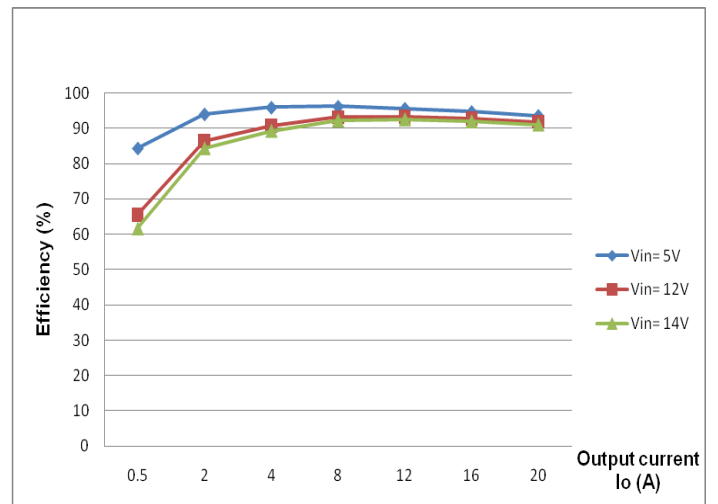

Figure 4: Converter efficiency vs. output current (2.5V out)

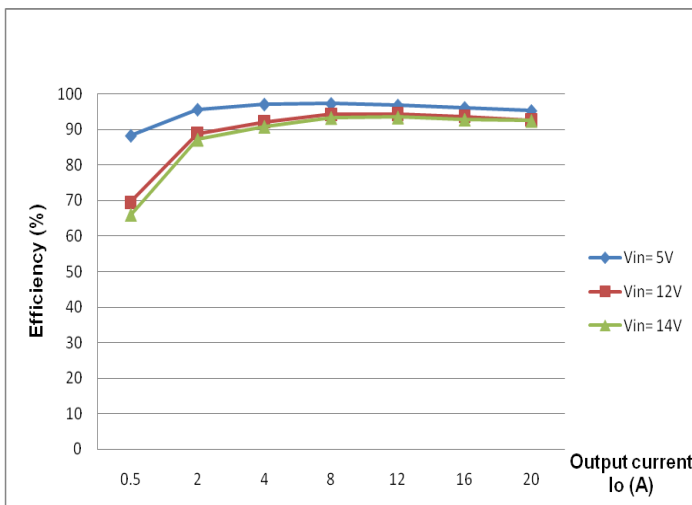

Figure 5: Converter efficiency vs. output current 3.3V out)

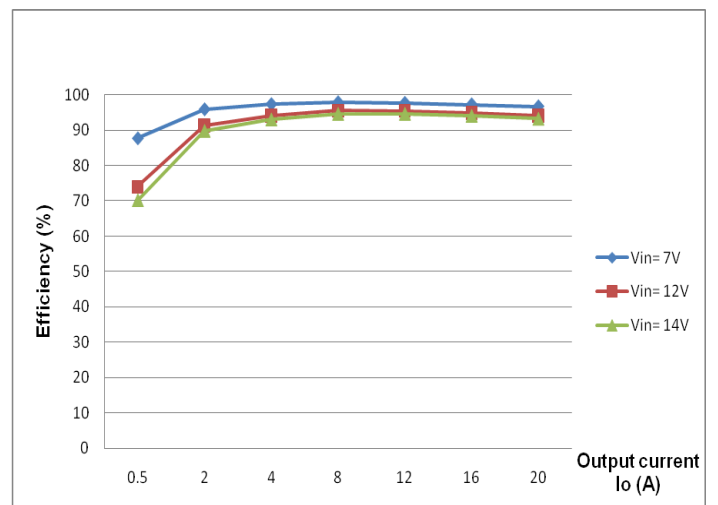

Figure 6: Converter efficiency vs. output current (5.0V out)

ELECTRICAL CHARACTERISTICS CURVES (CON.)

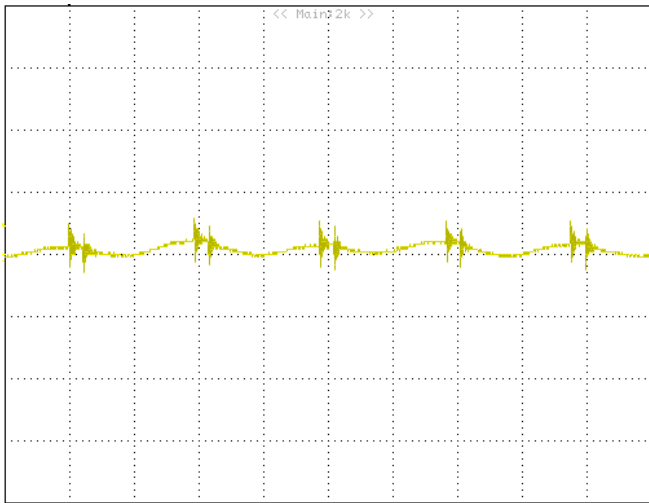

Figure 7: Output ripple & noise at 7Vin, 0.69V/20A out
CH1:VOUT, 20mV/div, 1uS/div

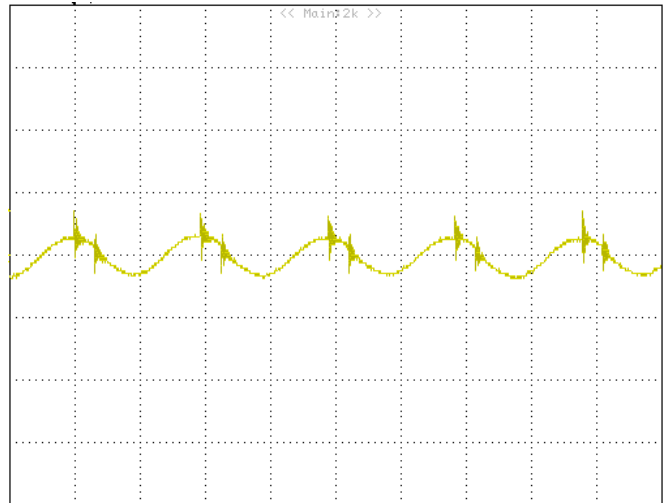

Figure 8: Output ripple & noise at 12Vin, 1.8V/20A out
CH1:VOUT, 20mV/div, 1uS/div

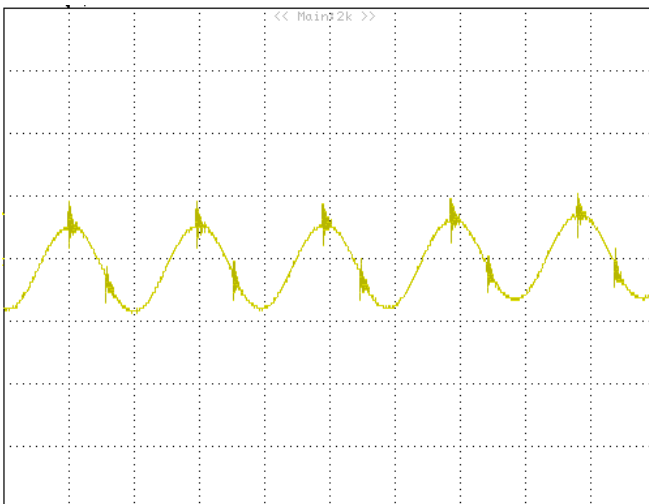

Figure 9: Output ripple & noise at 12Vin, 3.3V/20A out
CH1:VOUT, 20mV/div, 1uS/div

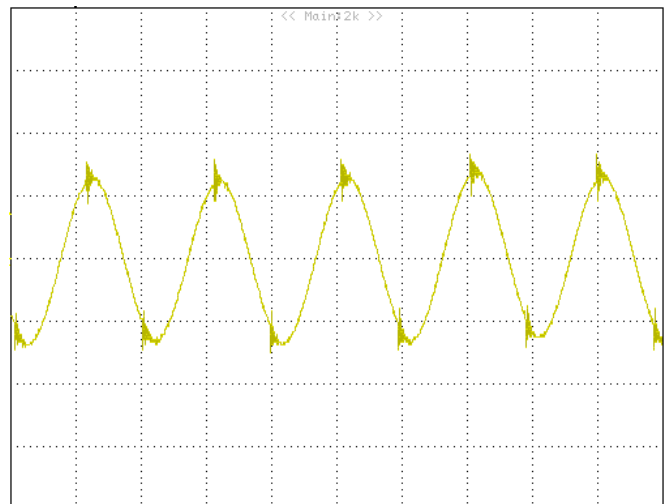

Figure 10: Output ripple & noise at 12Vin, 5.0V/20A out
CH1:VOUT, 20mV/div, 1uS/div

ELECTRICAL CHARACTERISTICS CURVES (CON.)

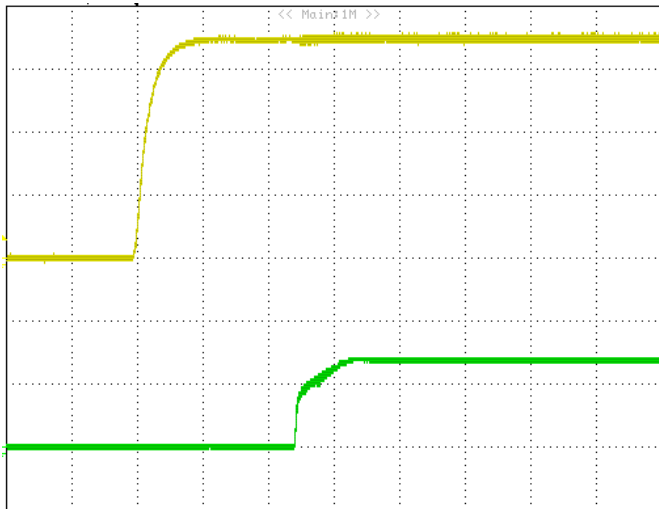

Figure 11: Turn on delay time at 7Vin, 0.69V/20A out.
(Green : VOUT, 0.5V/div, Yellow: VIN, 2V/div. 2mS/div)

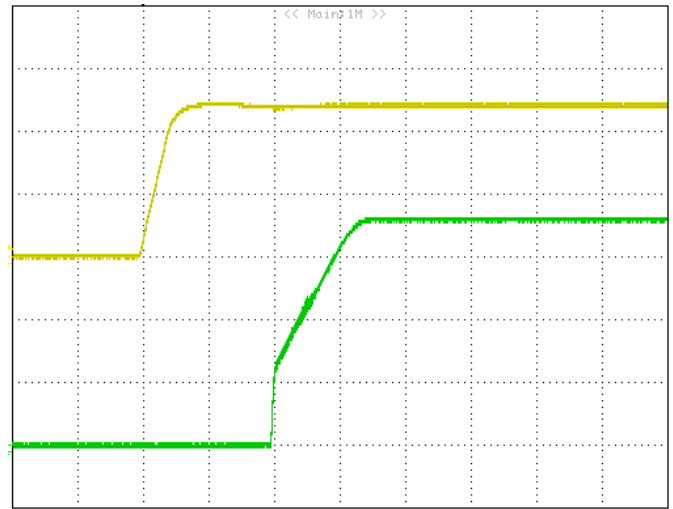

Figure 12: Turn on delay time at 12Vin, 1.8V/20A out.
(Green : VOUT, 0.5V/div, Yellow: VIN, 5V/div. 2mS/div)

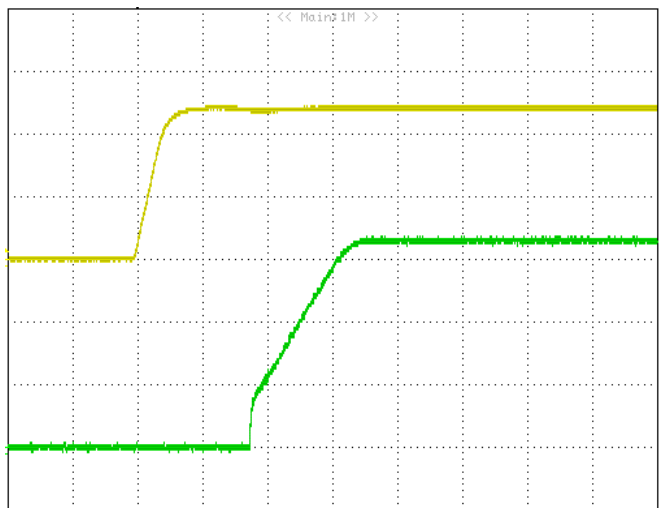

Figure 13: Turn on delay time at 12Vin, 3.3V/20A out.
(Green : VOUT, 1V/div, Yellow: VIN, 5V/div. 2mS/div)

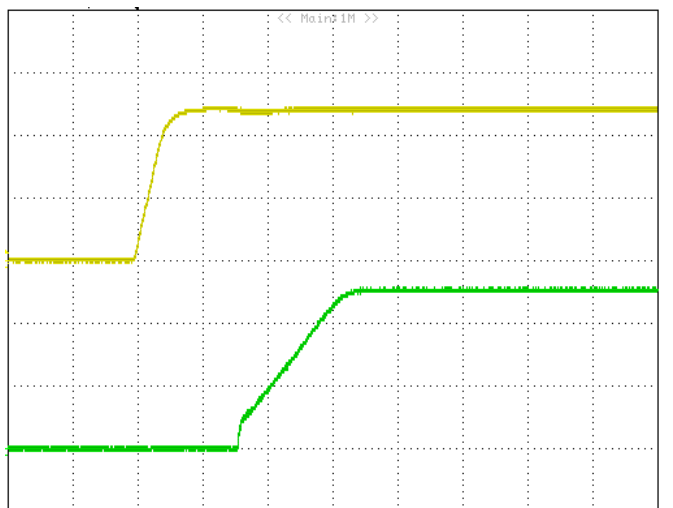

Figure 14: Turn on delay time at 12Vin, 5.0V/20A out.
(Green : VOUT, 2V/div, Yellow: VIN, 5V/div. 2mS/div)

ELECTRICAL CHARACTERISTICS CURVES (CON.)

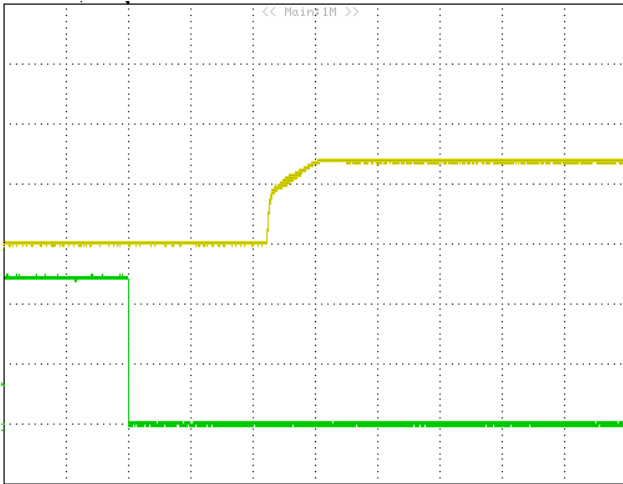

Figure 15: Turn on delay time at remote on 7Vin, 0.69V/20A out.
(Yellow: VOUT, 0.5V/div, Green: ON/OFF, 2V/div, 2mS/div)

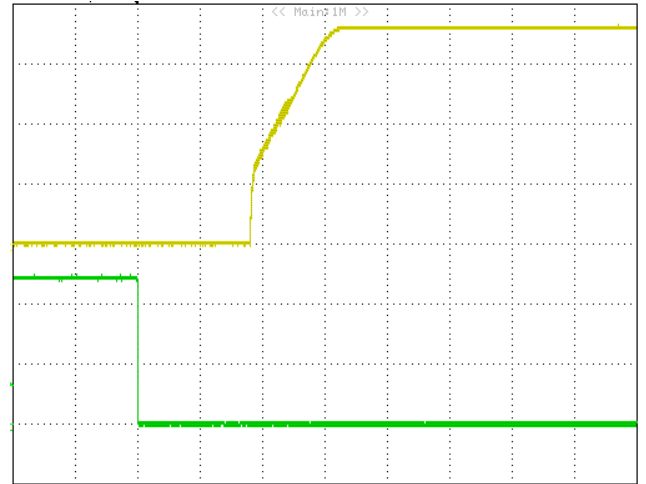

Figure16: Turn on delay time at remote on 12Vin, 1.8V/20A out.
(Yellow: VOUT, 0.5V/div, Green: ON/OFF, 2V/div, 2mS/div)

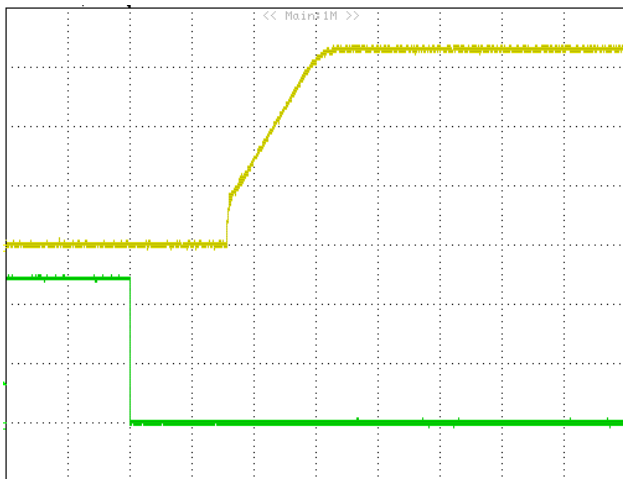

Figure 17: Turn on delay time at remote on 12Vin, 3.3V/20A out.
(Yellow: VOUT, 1V/div, Green: ON/OFF, 2V/div, 2mS/div)

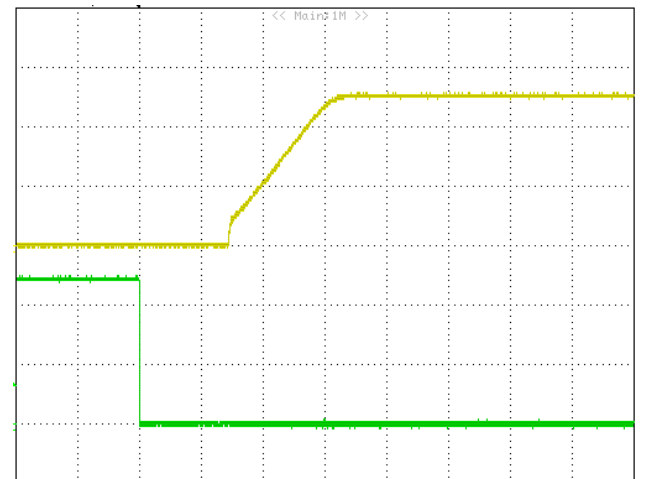

Figure 18: Turn on delay time at remote on 12Vin, 5.0V/20A out.
(Yellow: VOUT, 2V/div, Green: ON/OFF, 2V/div, 2mS/div)

ELECTRICAL CHARACTERISTICS CURVES

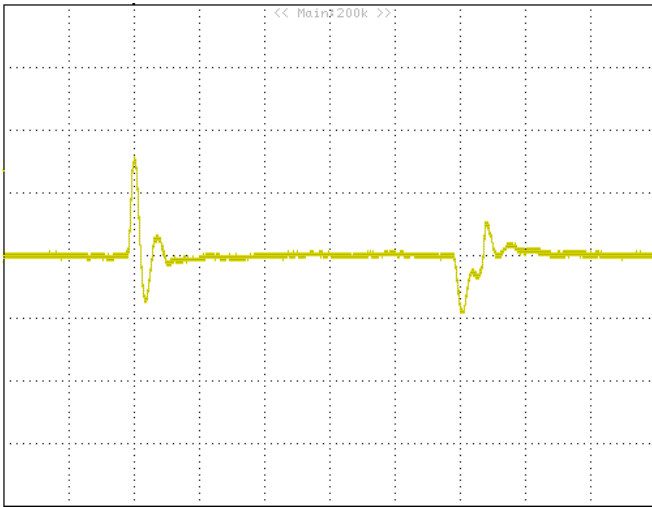

Figure 19: Transient response to dynamic load change at $2.5A/\mu S$ from 50%~ 100%~50% of I_o , max at 7Vin, 0.69Vout (Cout = 1uF ceramic, 47uF*2 +10uFceramic)
Yellow : VOUT, 0.2V/div, 100uS/div

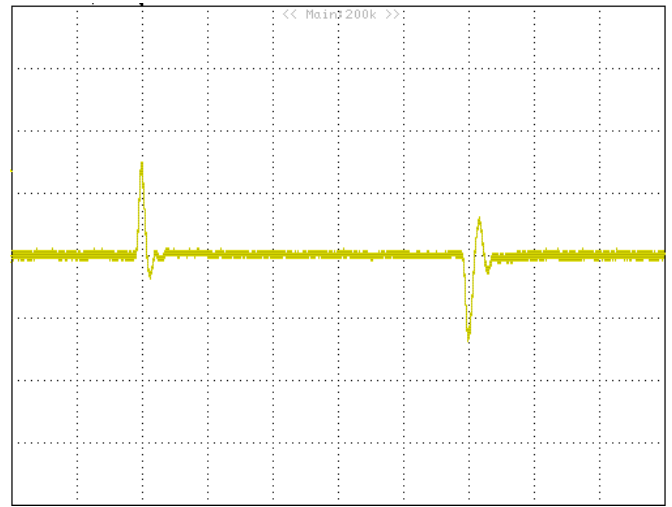

Figure 20: Transient response to dynamic load change at $2.5A/\mu S$ from 50%~ 100%~50% of I_o , max at 12Vin, 1.8Vout (Cout = 1uF ceramic, 47uF*2 +10uFceramic)
Yellow : VOUT, 0.2V/div, 100uS/div

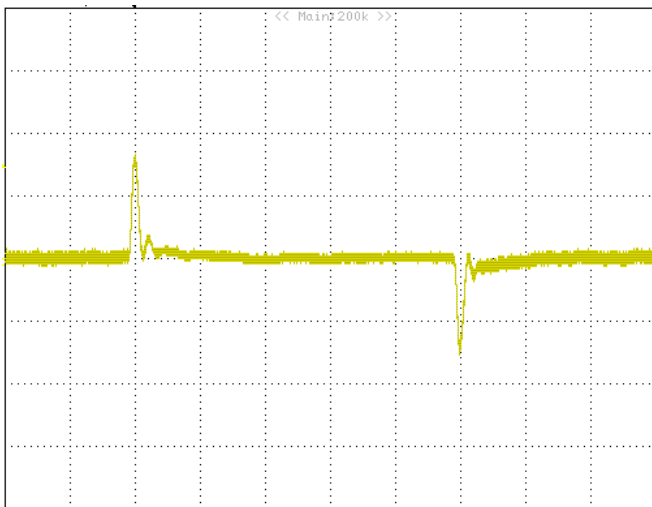

Figure 21: Transient response to dynamic load change at $2.5A/\mu S$ from 50%~ 100%~50% of I_o , max at 12Vin, 3.3Vout (Cout = 1uF ceramic, 47uF*2 +10uFceramic)
Yellow : VOUT, 0.2V/div, 100uS/div

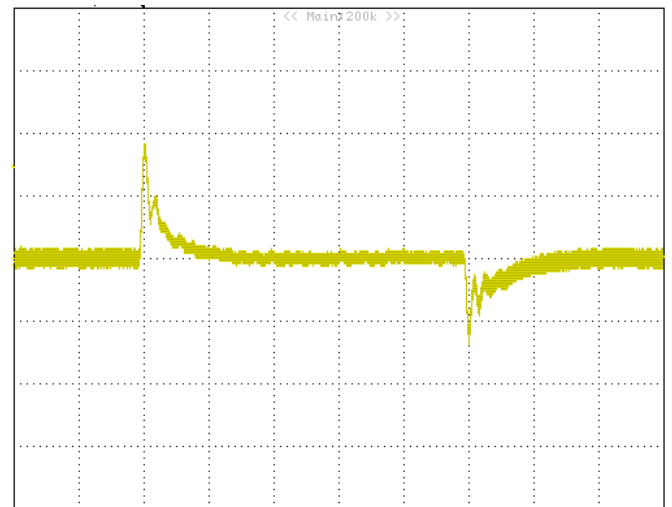

Figure 22: Transient response to dynamic load change at $2.5A/\mu S$ from 50%~ 100%~50% of I_o , max at 12Vin, 5Vout (Cout = 1uF ceramic, 47uF*2 +10uFceramic)
Yellow : VOUT, 0.2V/div, 100uS/div

ELECTRICAL CHARACTERISTICS CURVES (CON.)

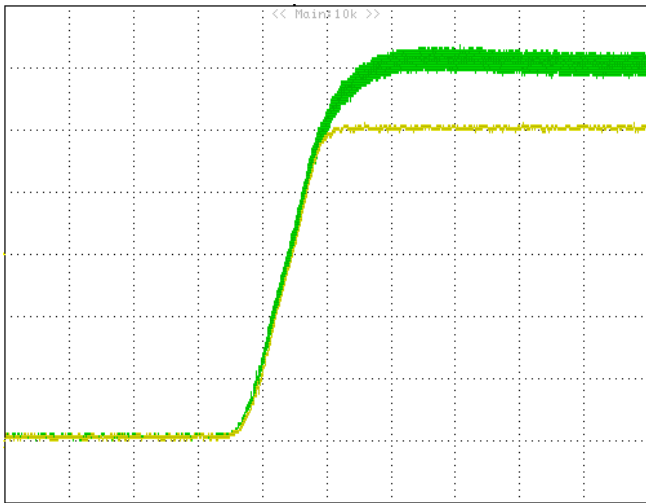

Figure 23: Tracking function, $V_{tracking}=6V$, $V_{out}= 5.0V$, full load
Yellow : V_{OUT} , (1V/div), Green: Tracking, (1V/div), 500uS/div

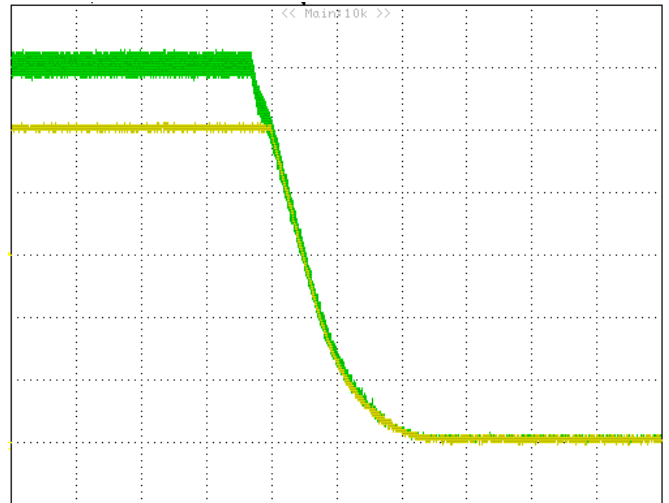

Figure 24:Tracking function, $V_{tracking}=6V$, $V_{out}= 5.0V$, full load
Yellow : V_{OUT} , (1V/div), Green: Tracking, (1V/div), 10mS/div

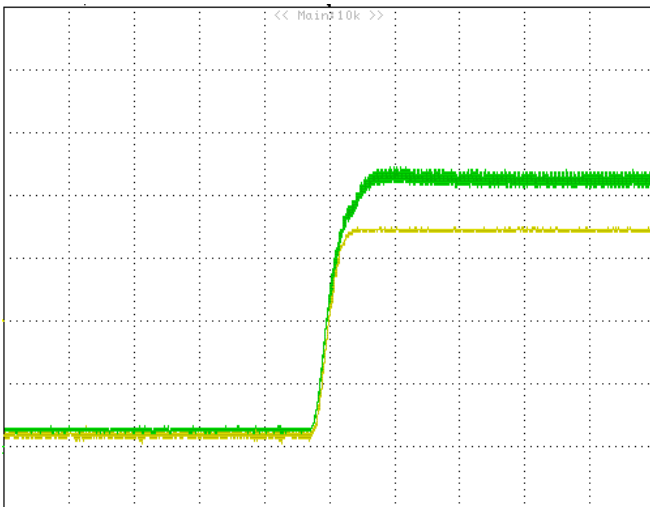

Figure 25: Tracking function, $V_{tracking}=0.8V$, $V_{out}=0.69V$, full load
Yellow: V_{OUT} , 0.2V/div, Green : Tracking, 0.2V/div, 1mS/div

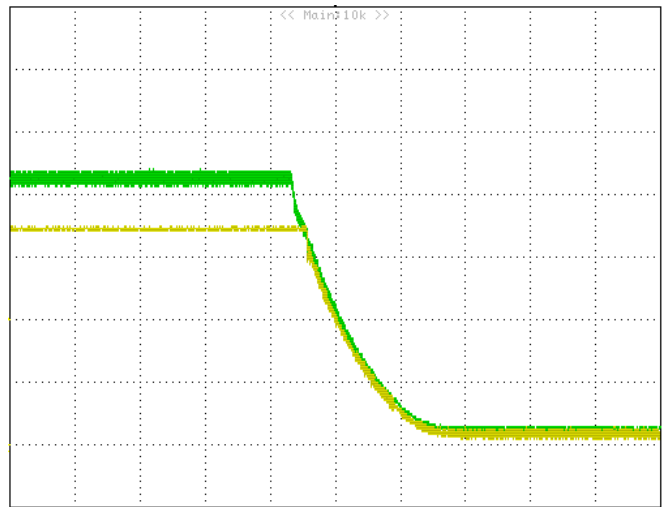
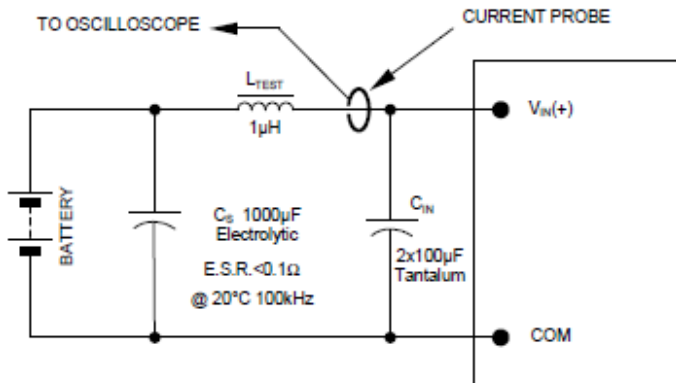

Figure 26:Tracking function, $V_{tracking}=0.8V$, $V_{out}= 0.69V$, full load
Yellow: V_{OUT} , 0.2V/div, Green : Tracking, 0.2V/div, 5mS/div

TEST CONFIGURATIONS



NOTE: Measure input reflected ripple current with a simulated source inductance (L_{TEST}) of $1\mu\text{H}$. Capacitor C_B offsets possible battery impedance. Measure current as shown above.

Figure 27: Input reflected-ripple current test setup

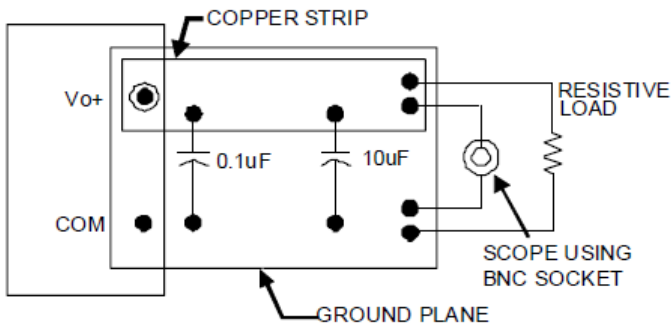

Note: Use a $10\mu\text{F}$ and $1\mu\text{F}$ capacitor. Scope measurement should be made using a BNC connector.

Figure 28: Peak-peak output noise and startup transient measurement test setup.

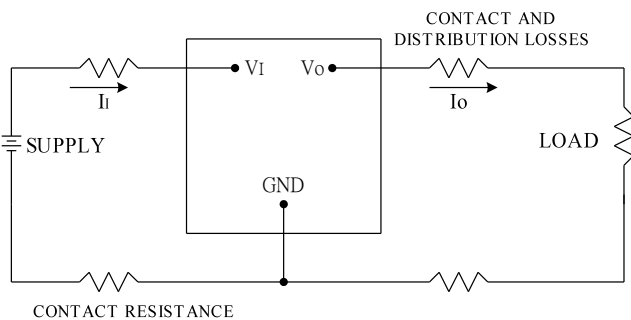

Figure 29: Output voltage and efficiency measurement test setup

Note: All measurements are taken at the module terminals. When the module is not soldered (via socket), place Kelvin connections at module terminals to avoid measurement errors due to contact resistance.

$$\eta = \left(\frac{V_o \times I_o}{V_i \times I_i} \right) \times 100 \quad \%$$

DESIGN CONSIDERATIONS

Input Source Impedance

To maintain low noise and ripple at the input voltage, it is critical to use low ESR capacitors at the input to the module. A highly inductive source can affect the stability of the module. An input capacitance must be placed close to the modules input pins to filter ripple current and ensure module stability in the presence of inductive traces that supply the input voltage to the module.

Safety Considerations

For safety-agency approval the power module must be installed in compliance with the spacing and separation requirements of the end-use safety agency standards.

For the converter output to be considered meeting the requirements of safety extra-low voltage (SELV), the input must meet SELV requirements. The power module has extra-low voltage (ELV) outputs when all inputs are ELV.

The input to these units is to be provided with a fast acting fuse with a maximum rating of 30A in the positive input lead.

FEATURES DESCRIPTIONS

Remote On/Off

The DCL series power modules have an On/Off pin for remote On/Off operation. Both positive and negative On/Off logic options are available in the DCL series power modules.

For positive logic module, connect an open collector (NPN) transistor or open drain (N channel) MOSFET between the On/Off pin and the GND pin (see figure 30). Positive logic On/Off signal turns the module ON during the logic high and turns the module OFF during the logic low. When the positive On/Off function is not used, leave the pin floating or tie to V_{in} (module will be On).

For negative logic module, the On/Off pin is pulled high with an external pull-up $5k\Omega$ resistor (see figure 31). Negative logic On/Off signal turns the module OFF during logic high and turns the module ON during logic low. If the negative On/Off function is not used, leave the pin floating or tie to GND. (module will be on)

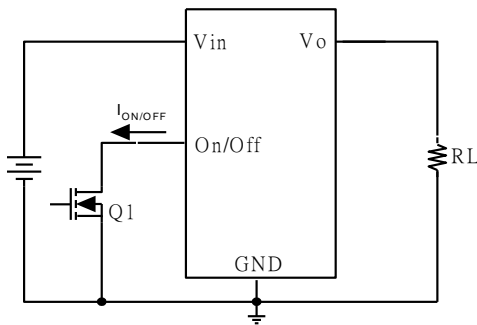

Figure 30: Positive remote On/Off implementation

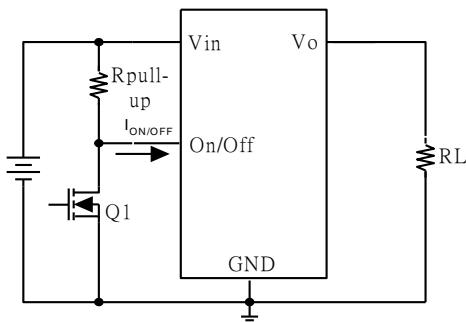

Figure 31: Negative remote On/Off implementation

Input Under voltage Lockout

At input voltages below the input under voltage lockout limit, the module operation is disabled. The module will begin to operate at an input voltage above the under voltage lockout turn-on threshold.

Over-Current Protection

To provide protection in an output over load fault condition, the unit is equipped with internal over-current protection. When the over-current protection is triggered, the unit enters hiccup mode. The units operate normally once the fault condition is removed.

Remote Sense

The DCL provide V_o remote sensing to achieve proper regulation at the load points and reduce effects of distribution losses on output line. In the event of an open remote sense line, the module shall maintain local sense regulation through an internal resistor. The module shall correct for a total of 0.5V of loss. The remote sense line impedance shall be $< 10\Omega$.

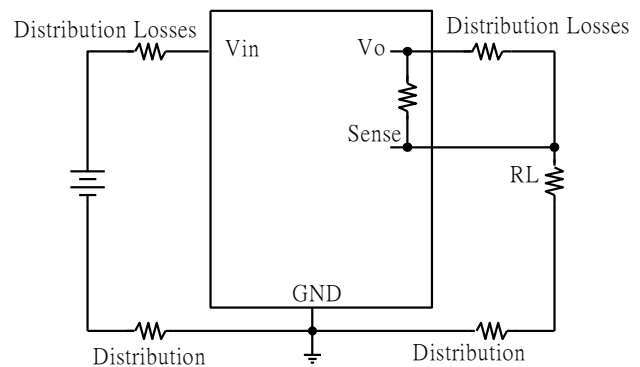

Figure 32: Effective circuit configuration for remote sense operation

Output Voltage Programming

The output voltage of the DCL can be programmed to any voltage between 0.69Vdc and 5.5Vdc by connecting one resistor (shown as Rtrim in Figure 33) between the TRIM and GND pins of the module. Without this external resistor, the output voltage of the module is 0.69 Vdc. To calculate the value of the resistor Rtrim for a particular output voltage Vo, please use the following equation:

$$R_{trim} = \left[\frac{6.9}{V_o - 0.69} \right] K\Omega$$

Rtrim is the external resistor in kΩ

Vo is the desired output voltage.

For example, to program the output voltage of the DCL module to 5.0Vdc, Rtrim is calculated as follows:

$$R_{trim} = \left[\frac{6.9}{5.0 - 0.69} \right] K\Omega = 1.601K\Omega$$

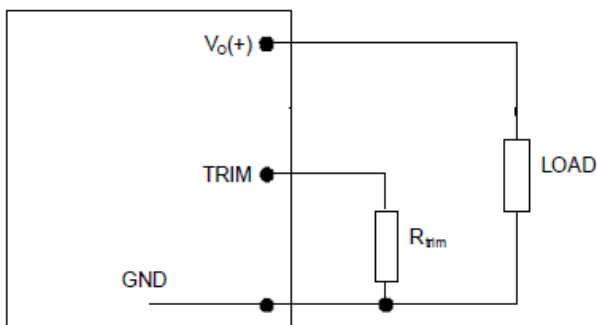

Figure 33: Circuit configuration for programming output voltage using an external resistor.

Table 1 provides Rtrim values required for some common output voltages. By using a ±0.5% tolerance trim resistor with a TC of

±100ppm, a set point tolerance of ±1.5% can be achieved as specified in the electrical specification.

Table 1

V _{O, set} (V)	R _{trim} (KΩ)
0.7	690
1.0	22.26
1.2	13.53
1.5	8.519
1.8	6.216
2.5	3.812
3.3	2.644
5.0	1.601

Certain restrictions apply on the output voltage set point depending on the input voltage. These are shown in the Output Voltage vs. Input Voltage Set Point Area plot in Fig. 34.

The Upper Limit curve shows that for output voltages of 0.9V and lower, the input voltage must be lower than the maximum of 14V.

The Lower Limit curve shows that for output voltages of 3.3V and higher, the input voltage needs to be larger than the minimum of 4.5V

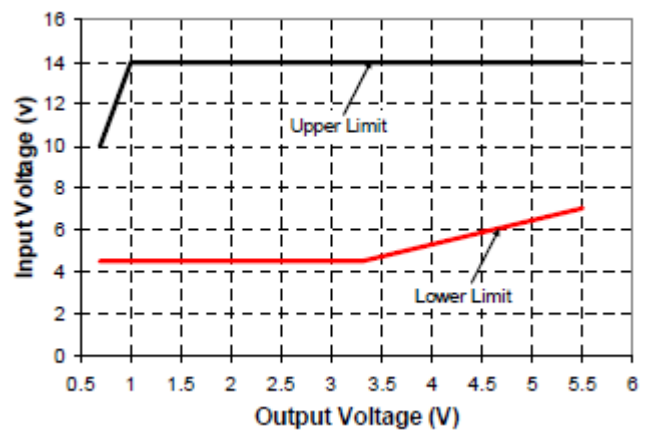

Figure 34: Output voltage vs input voltage setpoint area plot showing limits where the output can be set for different input voltage.

FEATURE DESCRIPTIONS (CON.)

Voltage Margining

Output voltage margining can be implemented in the DCL modules by connecting a resistor, Rmargin-up, from the Trim pin to the ground pin for margining-up the output voltage and by connecting a resistor, Rmargin-down, from the Trim pin to the output pin for margining-down. Figure 35 shows the circuit configuration for output voltage margining. If unused, leave the trim pin unconnected. A calculation tool is available from the evaluation procedure which computes the values of Rmargin-up and Rmargin-down for a specific output voltage and margin percentage.

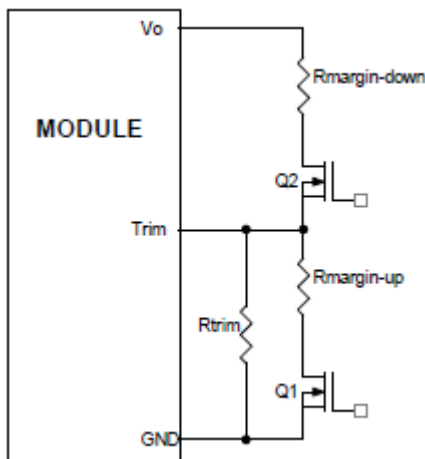

Figure 35: Circuit configuration for output voltage margining

Output Voltage Sequencing

The DCL 12V 20A modules include a sequencing feature, EZ-SEQUENCE that enables users to implement various types of output voltage sequencing in their applications. This is accomplished via an additional sequencing pin. When not using the sequencing feature, either tie the SEQ pin to VIN or leave it unconnected.

When an analog voltage is applied to the SEQ pin, the output voltage tracks this voltage until the output reaches the set-point voltage. The final value of the SEQ voltage must be set higher than the set-point voltage of the module. The output voltage follows the voltage on the SEQ pin on a one-to-one basis. By connecting multiple modules together, multiple modules can track their output voltages to the voltage applied on the SEQ pin.

For proper voltage sequencing, first, input voltage is applied to the module. The On/Off pin of the module is left unconnected (or tied to GND for negative logic modules or tied to VIN for positive logic modules) so that the module is ON by default. After applying input voltage to the module, a minimum 10msec delay is required before applying voltage on the SEQ pin. This delay gives the module enough time to complete its internal power-up soft-start cycle. During the delay time, the SEQ pin should be held close to ground (nominally $50\text{mV} \pm 20\text{mV}$). This is required to keep the internal op-amp out of saturation thus preventing output overshoot during the start of the sequencing ramp. By selecting resistor R1 (see Figure. 37) according to the following equation

$$R1 = \left[\frac{24950}{V_{in} - 0.05} \right] \Omega$$

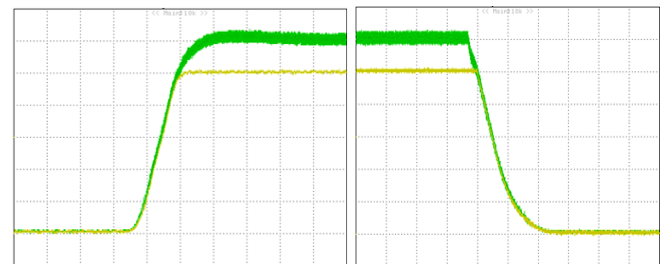

Figure 36: Sequential Start-up

The voltage at the sequencing pin will be 50mV when the sequencing signal is at zero.

FEATURE DESCRIPTIONS (CON.)

After the 10msec delay, an analog voltage is applied to the SEQ pin and the output voltage of the module will track this voltage on a one-to-one volt bases until the output reaches the set-point voltage. To initiate simultaneous shutdown of the modules, the SEQ pin voltage is lowered in a controlled manner. The output voltage of the modules tracks the voltages below their set-point voltages on a one-to-one basis. A valid input voltage must be maintained until the tracking and output voltages reach ground potential.

When using the EZ-SEQUENCE™ feature to control start-up of the module, pre-bias immunity during startup is disabled. The pre-bias immunity feature of the module relies on the module being in the diode-mode during start-up. When using the EZ-SEQUENCE™ feature, modules goes through an internal set-up time of 10msec, and will be in synchronous rectification mode when the voltage at the SEQ pin is applied. This will result in the module sinking current if a pre-bias voltage is present at the output of the module.

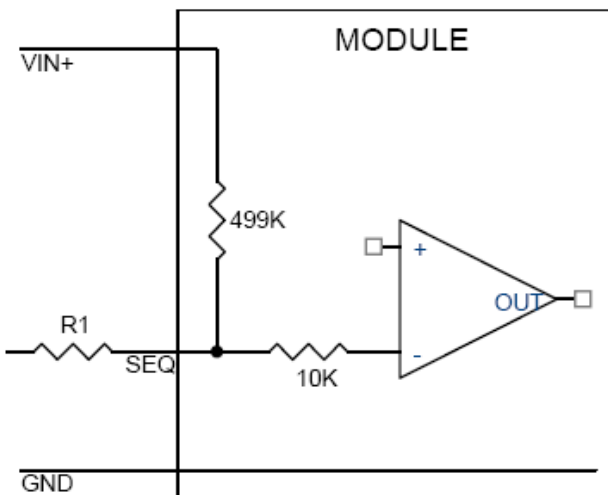

Figure 37: Circuit showing connection of the sequencing signal to the SEQ pin.

Power Good

The DCL modules provide a Power Good (PGOOD) signal that is implemented with an open-drain output to indicate that the output voltage is within the regulation limits of the power module. The PGOOD signal will be de-asserted to a low state if any condition such as over temperature, over current or loss of regulation occurs that would result in the output voltage going $\pm 10\%$ outside the set point value. The PGOOD terminal should be connected through a pull up resistor (suggested value 100K Ω) to a source of 5VDC or lower.

Monotonic Start-up and Shutdown

The DCL 20A modules have monotonic start-up and shutdown behavior for any combination of rated input voltage, output current and operating temperature range.

Synchronization

The DCL 20A modules can be synchronized using an external signal. Details of the SYNC signal are provided in below table. If the synchronization function is not being used, leave the SYNC pin floating.

Parameter	Notes	Min	Typ	Max	Units
Switching Frequency			500		kHz
Synchronization Frequency Range		520		600	kHz
High-Level Input Voltage		2.5			V
Low-Level Input Voltage				0.8	V
Input Current, SYNC	$V_{SYNC}=2.5V$			1	mA
Minimum Pulse Width, SYNC		250			nS
Minimum Setup/Hold Time, SYNC ²		250			nS

THERMAL CONSIDERATIONS

Thermal management is an important part of the system design. To ensure proper, reliable operation, sufficient cooling of the power module is needed over the entire temperature range of the module. Convection cooling is usually the dominant mode of heat transfer.

Hence, the choice of equipment to characterize the thermal performance of the power module is a wind tunnel.

Thermal Testing Setup

Delta's DC/DC power modules are characterized in heated vertical wind tunnels that simulate the thermal environments encountered in most electronics equipment. This type of equipment commonly uses vertically mounted circuit cards in cabinet racks in which the power modules are mounted.

The following figure shows the wind tunnel characterization setup. The power module is mounted on a test PWB and is vertically positioned within the wind tunnel.

Thermal Derating

Heat can be removed by increasing airflow over the module. To enhance system reliability, the power module should always be operated below the maximum operating temperature. If the temperature exceeds the maximum module temperature, reliability of the unit may be affected.

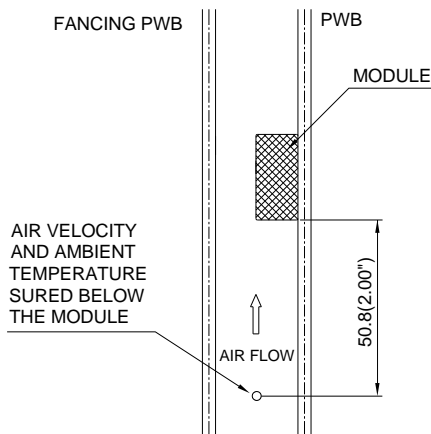

Note: Wind Tunnel Test Setup Figure Dimensions are in millimeters and (Inches)

Figure 38: Wind tunnel test setup

THERMAL CURVES

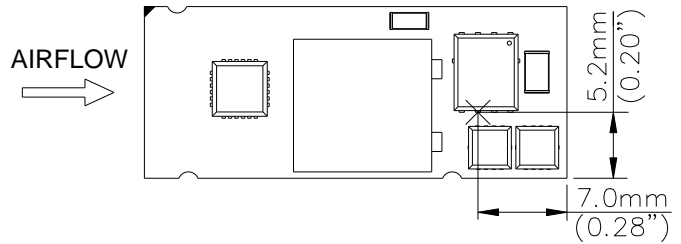

Figure 39: Temperature measurement location

The allowed maximum hot spot temperature is defined at 117°C

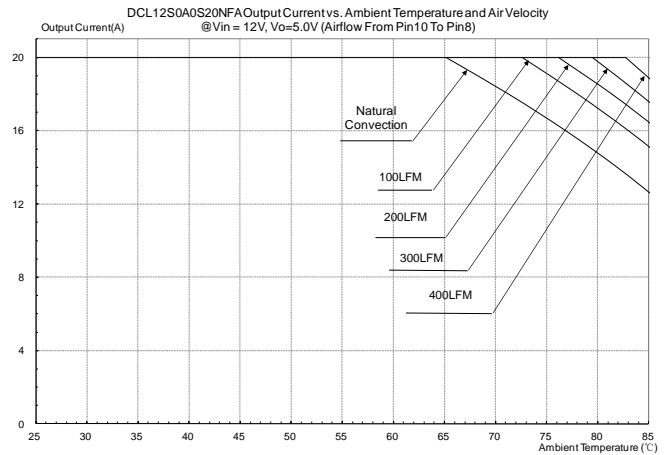

Figure 40: Output current vs. ambient temperature and air velocity @Vin=12V, Vout=5.0V(Either Orientation)

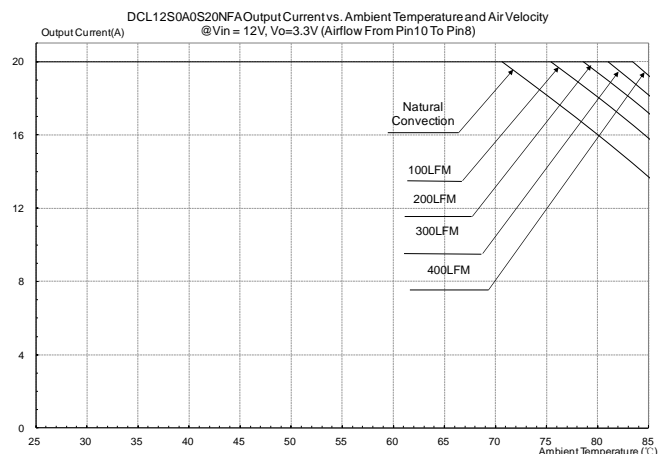

Figure 41: Output current vs. ambient temperature and air velocity @Vin=12V, Vout=3.3V(Either Orientation)

THERMAL CURVES

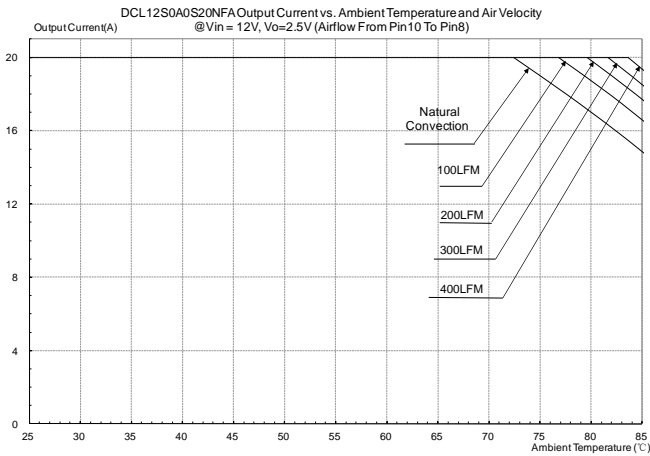

Figure 42: Output current vs. ambient temperature and air velocity @ Vin=12V, Vout=2.5V (Either Orientation)

THERMAL CURVES

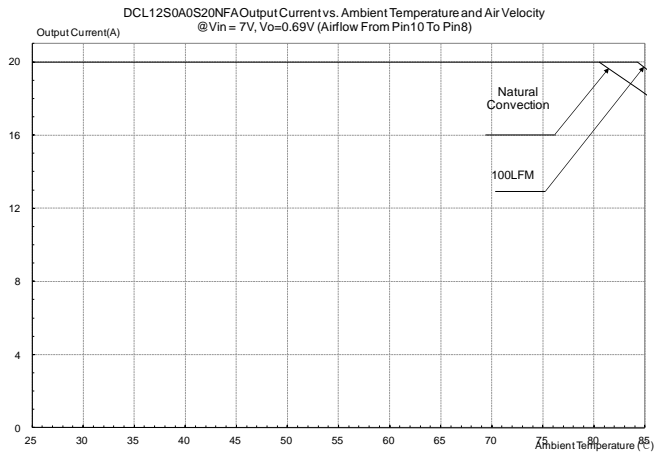

Figure 45: Output current vs. ambient temperature and air velocity @ Vin=7V, Vout=0.69V (Either Orientation)

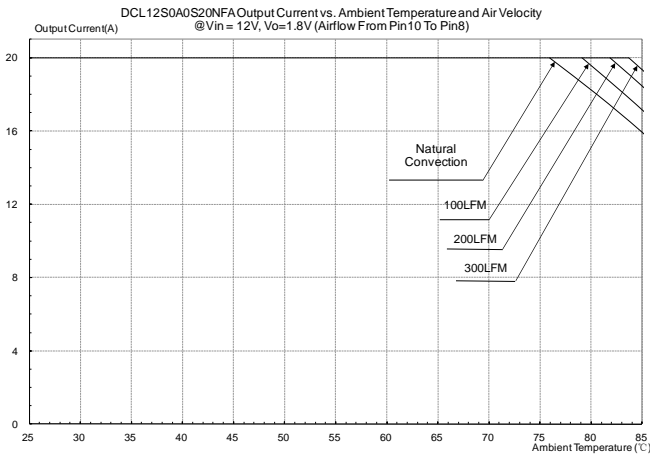

Figure 43: Output current vs. ambient temperature and air velocity @ Vin=12V, Vout=1.8V (Either Orientation)

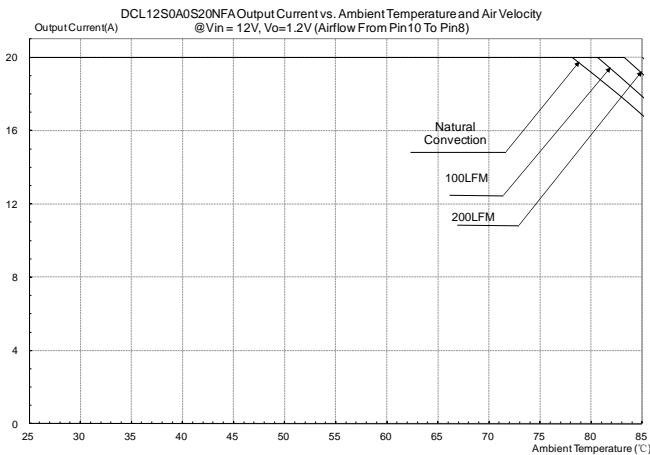
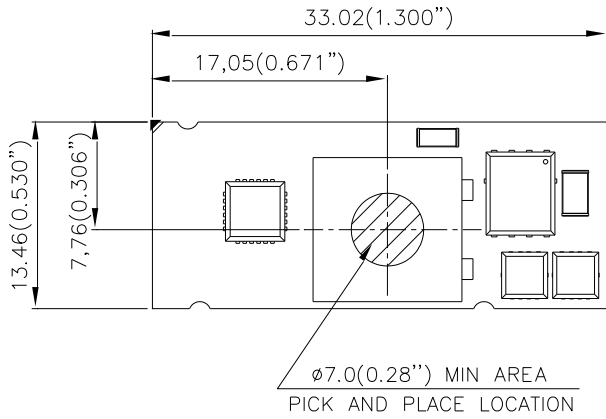

Figure 44: Output current vs. ambient temperature and air velocity @ Vin=12V, Vout=1.2V (Either Orientation)

PICK AND PLACE LOCATION



NOTES:
ALL DIMENSIONS ARE IN MILLIMETERS AND (INCHES)
TOLERANCES: X.Xmm±0.5mm(X.XX in.±0.02 in.)
X.XXmm±0.25mm(X.XXX in.±0.010 in.)

RECOMMENDED PAD LAYOUT

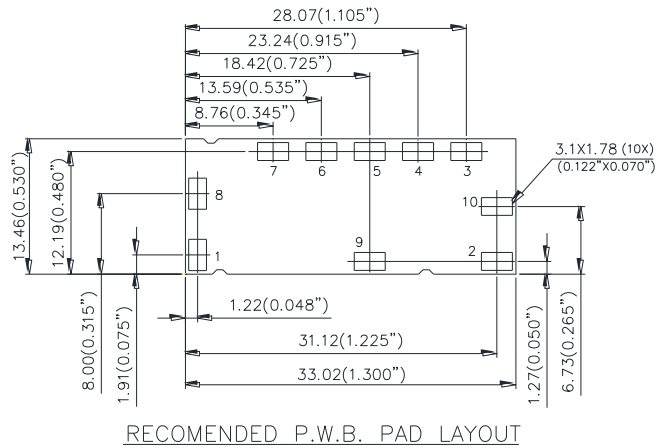

NOTES:
DIMENSIONS ARE IN MILLIMETERS AND (INCHES)
TOLERANCES: X.Xmm±0.5mm(X.XX in.±0.02 in.)
X.XXmm±0.25mm(X.XXX in.±0.010 in.)

SURFACE-MOUNT TAPE & REEL

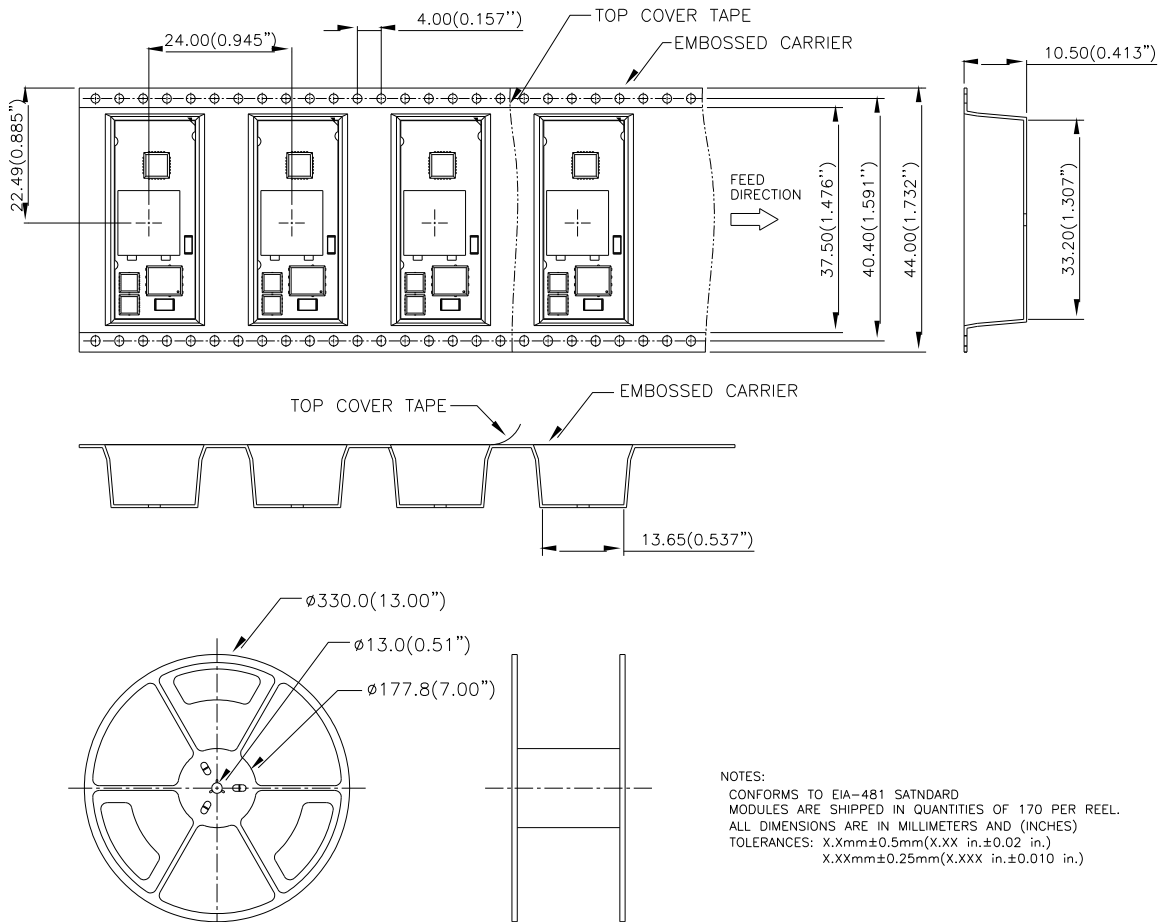

NOTES:
CONFORMS TO EIA-481 SATNDARD
MODULES ARE SHIPPED IN QUANTITIES OF 170 PER REEL.
ALL DIMENSIONS ARE IN MILLIMETERS AND (INCHES)
TOLERANCES: X.Xmm±0.5mm(X.XX in.±0.02 in.)
X.XXmm±0.25mm(X.XXX in.±0.010 in.)

LEAD (Sn/Pb) PROCESS RECOMMEND TEMP. PROFILE

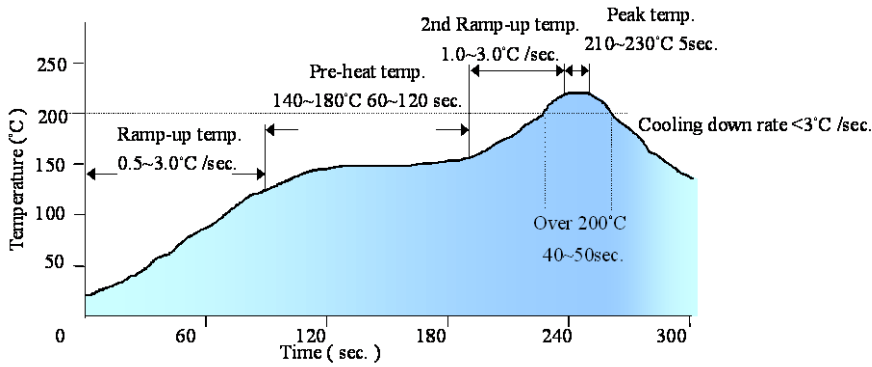

Note: The temperature refers to the pin of DCL, measured on the pin Vout joint.

LEAD FREE (SAC) PROCESS RECOMMEND TEMP. PROFILE

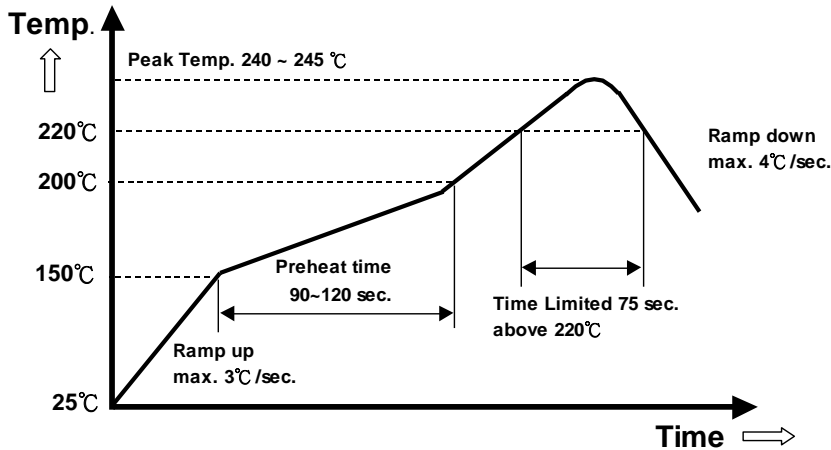

Note: The temperature refers to the pin of DCL, measured on the pin Vout joint.

MECHANICAL DRAWING

TOP VIEW

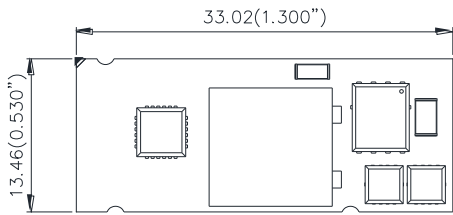

SIDE VIEW

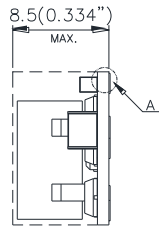

BOTTOM VIEW

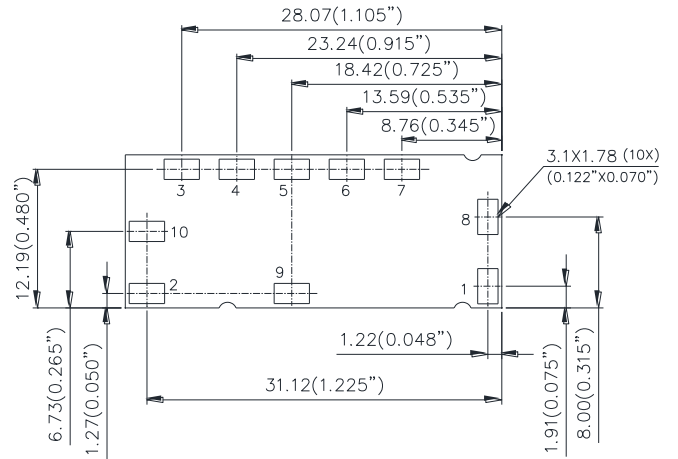

PIN#	FUNCTION
1	ON/OFF
2	VIN
3	SEQ
4	GND
5	VOUT
6	TRIM
7	VS+
8	VS-
9	PG
10	SYNC

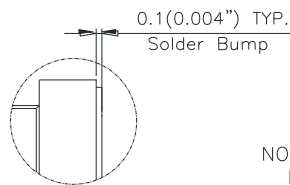

DETAIL "A"
SCALE 5/1

NOTES:
DIMENSIONS ARE IN MILLIMETERS AND (INCHES)
TOLERANCES: X.Xmm±0.5mm(X.XX in.±0.02 in.)
X.XXmm±0.25mm(X.XXX in.±0.010 in.)



PART NUMBERING SYSTEM

DCL	12	S	0A0	S	20	N	F	A
Product Series	Input Voltage	Numbers of Outputs	Output Voltage	Package Type	Output Current	On/Off logic		Option Code
DCT-3A DCS - 6A DCM - 12A DCL - 20A	04 - 2.4~5.5V 12 - 4.5~14V	S - Single	0A0 - Programmable	S - SMD	03-3A 06 - 6A 12 - 12A 20 - 20A	N- negative P- positive	F- RoHS 6/6 (Lead Free)	A - Standard Function

MODEL LIST

Model Name	Packaging	Input Voltage	Output Voltage	Output Current	Efficiency 12Vin, 5Vdc @ 20A
DCL12S0A0S20NFA	SMD	4.5V ~ 14Vdc	0.69V~ 5.0Vdc	20A	93.0%

CONTACT: www.deltaww.com/dcdc

USA:

Telephone:
East Coast: 978-656-3993
West Coast: 510-668-5100
Fax: (978) 656 3964
Email: DCDC@delta-corp.com

Europe:

Telephone: +31-20-655-0967
Fax: +31-20-655-0999
Email: DCDC@delta-es.com

Asia & the rest of world:

Telephone: +886 3 4526107 x6220~6224
Fax: +886 3 4513485
Email: DCDC@delta.com.tw

WARRANTY

Delta offers a two (2) year limited warranty. Complete warranty information is listed on our web site or is available upon request from Delta.

Information furnished by Delta is believed to be accurate and reliable. However, no responsibility is assumed by Delta for its use, nor for any infringements of patents or other rights of third parties, which may result from its use. No license is granted by implication or otherwise under any patent or patent rights of Delta. Delta reserves the right to revise these specifications at any time, without notice.

Данный компонент на территории Российской Федерации

Вы можете приобрести в компании MosChip.

Для оперативного оформления запроса Вам необходимо перейти по данной ссылке:

<http://moschip.ru/get-element>

Вы можете разместить у нас заказ для любого Вашего проекта, будь то серийное производство или разработка единичного прибора.

В нашем ассортименте представлены ведущие мировые производители активных и пассивных электронных компонентов.

Нашей специализацией является поставка электронной компонентной базы двойного назначения, продукции таких производителей как XILINX, Intel (ex.ALTERA), Vicor, Microchip, Texas Instruments, Analog Devices, Mini-Circuits, Amphenol, Glenair.

Сотрудничество с глобальными дистрибьюторами электронных компонентов, предоставляет возможность заказывать и получать с международных складов практически любой перечень компонентов в оптимальные для Вас сроки.

На всех этапах разработки и производства наши партнеры могут получить квалифицированную поддержку опытных инженеров.

Система менеджмента качества компании отвечает требованиям в соответствии с ГОСТ Р ИСО 9001, ГОСТ РВ 0015-002 и ЭС РД 009

Офис по работе с юридическими лицами:

105318, г.Москва, ул.Щербаковская д.3, офис 1107, 1118, ДЦ «Щербаковский»

Телефон: +7 495 668-12-70 (многоканальный)

Факс: +7 495 668-12-70 (доб.304)

E-mail: info@moschip.ru

Skype отдела продаж:

moschip.ru

moschip.ru_4

moschip.ru_6

moschip.ru_9