

## Description

**General Notes**

The series contains indicators and illuminated pushbuttons with maintained and momentary action and one contact which may be normally closed or normally open (snap-action element for closing). The illuminated pushbuttons are fitted with snap-action or low-level switching systems.  
For technical data see pages 2 and 3.  
The front dimensions are 9 x 9 mm or 9 mm dia.

**Mounting**

Mounting from the front through the mounting hole is assured even when the wiring has already been attached (mounting dimensions and spacing see page 4.).  
The units are equipped with soldering or plug-in terminals.

**Lenses**

The flat lenses, made of polycarbonate, are obtainable in various colours. The transparent lens is available with translucent or transparent support.

**Marking**

A limited amount of marking can be provided.

**Illumination**

Perfect illumination of the different coloured lenses is assured by filament lamps bipin T1 longlife (6-36 V) or LED bipin T1 (2,2 V) in the colours red, yellow and green.

**Position Indication**

When a switch with maintained action is actuated, the lens remains in the depressed position mechanically. The state of the switch is apparent at all times from the position of the lens.

**How to order**

19-XXX.0X5

└── Contact material  
└── Switch variant

19-9XX.X

Lens

19-9XX.X

Other accessories

Example:

- Illuminated pushbutton; round, momentary action, gold-plated silver contact, soldering terminals  
19-139.035
- Lens, round, red  
19-931.2

*All dimensions in mm.  
We reserve the right to modify technical data.*

### Switching system

Single-break, snap-action switching system; 1 normally open contact

### Contact material

- gold-plated silver
- silver, suitable for over 20 V

### Travel

2,8 mm

### Actuating force (measured at the lens)

1,6 N (160 g)

### Switch rating

50 VAC/72 VDC, 1 A (silver-plated)  
50 VAC/72 VDC, 100 mA (gold-plated)

### Mechanical life

2 million operations

### Electric strength

2500 VAC, 50 Hz, 1 min between all terminals and earth, as per IEC 512-2-11.

### Terminals

Max. wire diameter: 2 wires of 0,8 mm each  
Max. wire cross-section of stranded cable: 1 x 0,75 mm<sup>2</sup>

### Ambient temperature

-25 °C to +65 °C without lamp  
-25 °C to +45 °C with lamp  
-25 °C to +65 °C with LED

For indicators and illuminated pushbuttons mounted as a block, make sure the heat can escape freely.

### Storage temperature

-40 °C to +85 °C

### Actuator case

Made of polyphenylene oxide, self-extinguishing  
Colour, black

### Degree of protection of front as per IEC 529

IP 40

### Approvals

SEV

**Switching system**

This low-level switching system was designed for switching low powers in electronic circuits.

The switching system assures reliable switching of loads. Single-break momentary contact, as normally open or normally closed with 4 independent points of contact. Special features are the long life, extremely short rebound time and stable contact resistance.

**Contact material**

gold-plated

**Travel**

2,8 mm

**Actuating force** (measured at the lens)

1,8 N  $\pm$  0,3 (180 g)

**Switch rating**

10  $\mu$ A/100  $\mu$ V to 100 mA at 42 VAC/VDC

**Contact resistance**

Value as new  $\leq$  50 m $\Omega$  as per IEC 512-2, test 2b

**Rebound time**

typical < 100  $\mu$ s

**Mechanical life**

5 million operations

**Electric strength**

2500 VAC, 50 Hz, 1 min between all terminals and earth, as per IEC 512-2-11.

**Terminals**

The universal terminals permit these units to be mounted on printed circuit boards (PCB). These terminals can also be used as soldering or plug-in terminals. For these terminals we can also supply a plug-in base which, when soldered on to the board, enables the switch to be plugged in.

Max. wire diameter: 2 wires of 0,8 mm each

Max. wire cross-section of stranded cable: 1 x 0,75 mm<sup>2</sup>

Plug-in terminal: 2,0 x 0,5 mm

**Ambient temperature**

-25 °C to +65 °C without lamp

-25 °C to +45 °C with lamp

-25 °C to +65 °C with LED

For indicators and illuminated pushbuttons mounted as a block, make sure the heat can escape freely.

**Storage temperature**

-40 °C to +85 °C

**Shockproof** (single impact, semi-sinusoidal)

15 g for 11 ms as per IEC 68-2-27

**Actuator case**

Made of polyphenylene oxide, self-extinguishing

Colour, black; grey can only be supplied on request.

**Degree of protection** of front as per IEC 529

IP 40

Dimensions refer to page 5

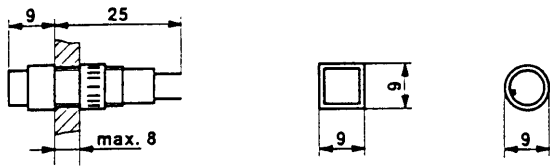

Indicators reduced

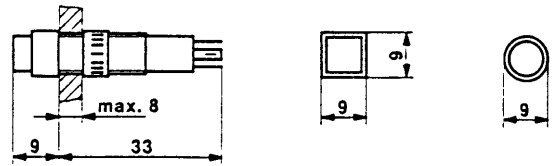

Illuminated pushbuttons with snap-action switching system

Dimensions refer to page 6

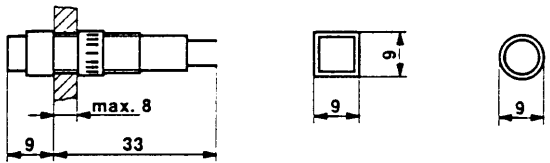

Indicators

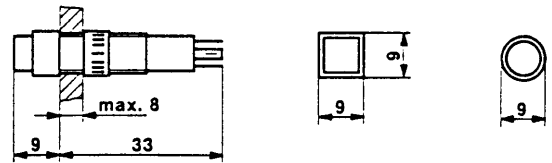

Illuminated pushbuttons with low-level switching system

Mounting dimensions Indicators, illuminated pushbuttons

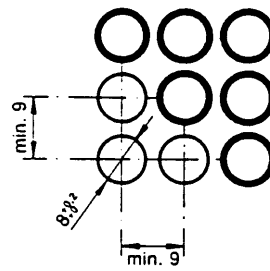
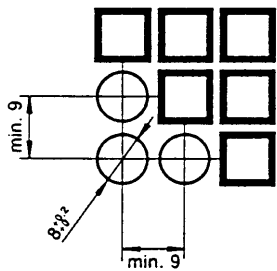

## Terminals

Indicator

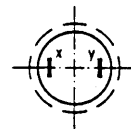
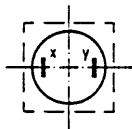

Illuminated pushbutton with snap-action switching system and low-level switching system

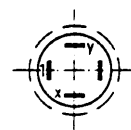
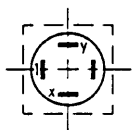

# Indicator, Illuminated Pushbuttons with Snap-action Switching System

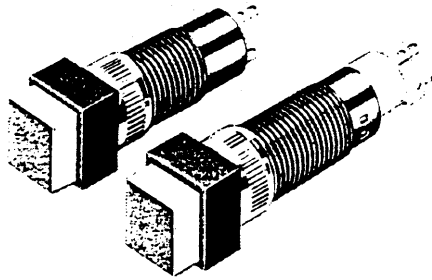

50 VAC/72 VDC, 1A

Dimensions see page 4

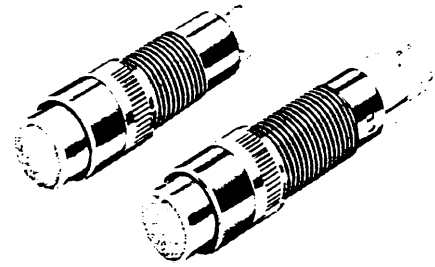

50 VAC/72 VDC, 1A

Order lenses separately  
see page 7

□ 9 mm  
○ 9 mm

Description	Momentary action	Maintained action		Type No.	Depth mm
Indicator reduced	-	-		□ 19-050.005 ○ 19-030.005	25
Illuminated pushbutton 1 normally open contact silver contact 50 VAC/72 VDC, 1 A	x	-		□ 19-159.015 ○ 19-139.015	33
Illuminated pushbutton 1 normally open contact silver contact 50 VAC/72 VDC, 1 A	-	x		□ 19-289.015 ○ 19-279.015	33
Illuminated pushbutton 1 normally open contact silver, gold-plated 50 VAC/72 VDC, 100 mA	x	-		□ 19-159.035 ○ 19-139.035	33
Illuminated pushbutton 1 normally open contact silver, gold-plated 50 VAC/72 VDC, 100 mA	-	x		□ 19-289.035 ○ 19-279.035	33

Please note our new series 18 with very small depth and compact indicators for direct connection to 2.2, 12 or 24 VDC.

For lamps see page 8

# Indicator, Illuminated Pushbuttons with Low-level Switching System

# 19 LL

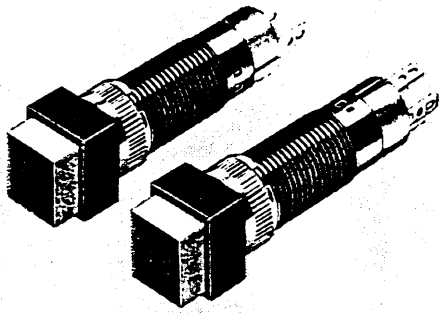

42 VAC/VDC, 100 mA

Dimensions see page 4

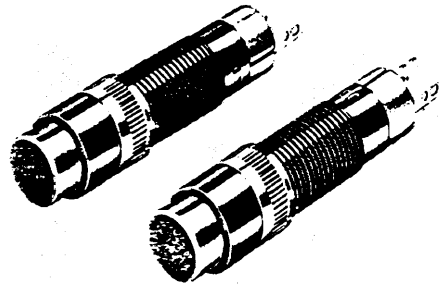









42 VAC/VDC, 100 mA

Order lenses separately see page 7







□ 9 mm



○ 9 mm

Description	Action		Type No.	Depth mm
	Momentary action	Maintained action		
Indicator (The total length is the same as that of the illuminated pushbutton)	-	-	 □19-051.005 ○19-031.005	33
Illuminated pushbutton 1 normally open contact	x	-	  □19-451.035 ○19-431.035	33
Illuminated pushbutton 1 normally closed contact	x	-	  □19-452.035 ○19-432.035	33
Illuminated pushbutton 1 normally open contact	-	x	  □19-481.035 ○19-471.035	33
Illuminated pushbutton 1 normally closed contact	-	x	  □19-482.035 ○19-472.035	33

Please note our new series 18 with very small depth and compact indicators for direct connection to 2.2, 12 or 24 VDC.



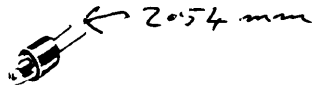
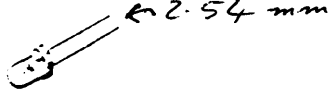

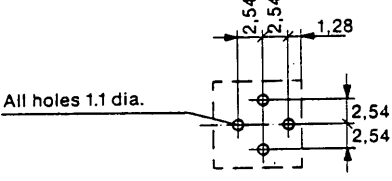
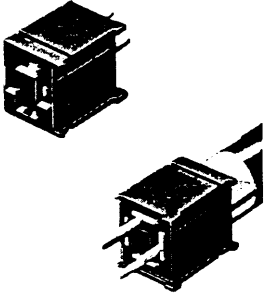
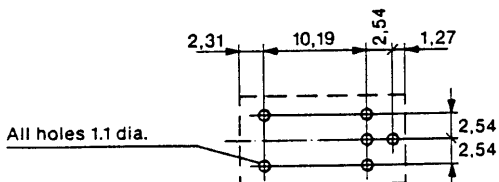

For lamps see page 8

Description	Colour	 7 x 7 mm	 7 mm			
	● opaque	Type No.	Type No.			
Flat, transparent lens with translucent support (for filament lamp and Multi-LED)	● black	19-951.0	19-931.0	 		
	red	19-951.2	19-931.2			
	yellow	19-951.4	19-931.4			
	green	19-951.5	19-931.5			
	blue	19-951.6	19-931.6			
	● grey	19-951.8	19-931.8			
	white	19-951.9	19-931.9			
	Flat, transparent lens with transparent support (for film insert and LED)	red	19-952.2		19-932.2	 
		yellow	19-952.4		19-932.4	
		green	19-952.5		19-932.5	
blue		19-952.6	19-932.6			
clear		19-952.7	19-932.7			

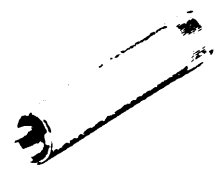
Description	Lamp voltage	Power consumption	Type No.		
<b>Lamp bipin T1</b> To prevent the casing from being overheated we recommend underrunning the lamp by 20%	6 V 12 V 18 V 24 V 28 V 36 V	117 mA 58 mA 28 mA 25 mA 25 mA 19 mA	19-903.0 19-903.1 19-903.2 19-903.3 19-903.4 19-903.5		
<b>LED bipin T1, 2,2 V</b> Pins 9 mm long		red yellow green	19-943.02 19-943.04 19-943.05		
<b>Multi-LED bipin T1</b> with built-in series resistor	red orange yellow green	28 V 28 V 28 V 28 V	20 mA 20 mA 15 mA 15 mA	11-968.32 11-968.33 11-968.34 11-968.35	
<b>Axial PCB plug-in base</b>			19-940		
<b>Right-angled PCB plug-in base</b>			19-941		
<b>Flat connector for plug-in terminals 2,0 mm</b> Insulating sleeve for flat connector 31-945			31-945 31-928		

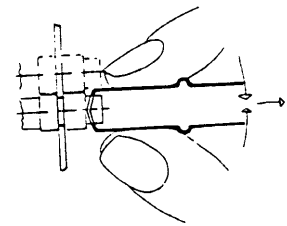

# Mounting Tools, Various

Description	Type No.	Image		
<b>Assembly wrench</b> for tightening (or loosening) fixing nuts	19-905			
Lamp remover	11-906			
<b>Dressing tool</b> used as aid to aligning buttons	19-906			
Lens remover	19-910			
Blind plug	square 9 x 9 mm	black	19-948.0	
Blind plug	circular 9 mm dia.	black	19-949.0	
<b>Fixing nut</b> 9 mm dia. x 13 mm Only for sheet < 3 mm thick	19-991			

## Данный компонент на территории Российской Федерации

### Вы можете приобрести в компании MosChip.

Для оперативного оформления запроса Вам необходимо перейти по данной ссылке:

<http://moschip.ru/get-element>

Вы можете разместить у нас заказ для любого Вашего проекта, будь то серийное производство или разработка единичного прибора.

В нашем ассортименте представлены ведущие мировые производители активных и пассивных электронных компонентов.

Нашей специализацией является поставка электронной компонентной базы двойного назначения, продукции таких производителей как XILINX, Intel (ex.ALTERA), Vicor, Microchip, Texas Instruments, Analog Devices, Mini-Circuits, Amphenol, Glenair.

Сотрудничество с глобальными дистрибьюторами электронных компонентов, предоставляет возможность заказывать и получать с международных складов практически любой перечень компонентов в оптимальные для Вас сроки.

На всех этапах разработки и производства наши партнеры могут получить квалифицированную поддержку опытных инженеров.

Система менеджмента качества компании отвечает требованиям в соответствии с ГОСТ Р ИСО 9001, ГОСТ РВ 0015-002 и ЭС РД 009

### Офис по работе с юридическими лицами:

105318, г.Москва, ул.Щербаковская д.3, офис 1107, 1118, ДЦ «Щербаковский»

Телефон: +7 495 668-12-70 (многоканальный)

Факс: +7 495 668-12-70 (доб.304)

E-mail: [info@moschip.ru](mailto:info@moschip.ru)

Skype отдела продаж:

moschip.ru

moschip.ru\_4

moschip.ru\_6

moschip.ru\_9