

Description

General Notes

The series contains indicators and illuminated pushbuttons with maintained and momentary action and one contact which may be normally closed or normally open (snap-action element for closing). The illuminated pushbuttons are fitted with snap-action or low-level switching systems.
For technical data see pages 2 and 3.
The front dimensions are 9 x 9 mm or 9 mm dia.

Mounting

Mounting from the front through the mounting hole is assured even when the wiring has already been attached (mounting dimensions and spacing see page 4.).
The units are equipped with soldering or plug-in terminals.

Lenses

The flat lenses, made of polycarbonate, are obtainable in various colours. The transparent lens is available with translucent or transparent support.

Marking

A limited amount of marking can be provided.

Illumination

Perfect illumination of the different coloured lenses is assured by filament lamps bipin T1 longlife (6-36 V) or LED bipin T1 (2,2 V) in the colours red, yellow and green.

Position Indication

When a switch with maintained action is actuated, the lens remains in the depressed position mechanically. The state of the switch is apparent at all times from the position of the lens.

How to order

19-XXX.0X5

└── Contact material
└── Switch variant

19-9XX.X

Lens

19-9XX.X

Other accessories

Example:

- Illuminated pushbutton; round, momentary action, gold-plated silver contact, soldering terminals
19-139.035
- Lens, round, red
19-931.2

*All dimensions in mm.
We reserve the right to modify technical data.*

Switching system

Single-break, snap-action switching system; 1 normally open contact

Contact material

- gold-plated silver
- silver, suitable for over 20 V

Travel

2,8 mm

Actuating force (measured at the lens)

1,6 N (160 g)

Switch rating

50 VAC/72 VDC, 1 A (silver-plated)
50 VAC/72 VDC, 100 mA (gold-plated)

Mechanical life

2 million operations

Electric strength

2500 VAC, 50 Hz, 1 min between all terminals and earth, as per IEC 512-2-11.

Terminals

Max. wire diameter: 2 wires of 0,8 mm each
Max. wire cross-section of stranded cable: 1 x 0,75 mm²

Ambient temperature

-25 °C to +65 °C without lamp
-25 °C to +45 °C with lamp
-25 °C to +65 °C with LED

For indicators and illuminated pushbuttons mounted as a block, make sure the heat can escape freely.

Storage temperature

-40 °C to +85 °C

Actuator case

Made of polyphenylene oxide, self-extinguishing
Colour, black

Degree of protection of front as per IEC 529

IP 40

Approvals

SEV

Switching system

This low-level switching system was designed for switching low powers in electronic circuits.

The switching system assures reliable switching of loads. Single-break momentary contact, as normally open or normally closed with 4 independent points of contact. Special features are the long life, extremely short rebound time and stable contact resistance.

Contact material

gold-plated

Travel

2,8 mm

Actuating force (measured at the lens)

1,8 N \pm 0,3 (180 g)

Switch rating

10 μ A/100 μ V to 100 mA at 42 VAC/VDC

Contact resistance

Value as new \leq 50 m Ω as per IEC 512-2, test 2b

Rebound time

typical < 100 μ s

Mechanical life

5 million operations

Electric strength

2500 VAC, 50 Hz, 1 min between all terminals and earth, as per IEC 512-2-11.

Terminals

The universal terminals permit these units to be mounted on printed circuit boards (PCB). These terminals can also be used as soldering or plug-in terminals. For these terminals we can also supply a plug-in base which, when soldered on to the board, enables the switch to be plugged in.

Max. wire diameter: 2 wires of 0,8 mm each

Max. wire cross-section of stranded cable: 1 x 0,75 mm²

Plug-in terminal: 2,0 x 0,5 mm

Ambient temperature

-25 °C to +65 °C without lamp

-25 °C to +45 °C with lamp

-25 °C to +65 °C with LED

For indicators and illuminated pushbuttons mounted as a block, make sure the heat can escape freely.

Storage temperature

-40 °C to +85 °C

Shockproof (single impact, semi-sinusoidal)

15 g for 11 ms as per IEC 68-2-27

Actuator case

Made of polyphenylene oxide, self-extinguishing

Colour, black; grey can only be supplied on request.

Degree of protection of front as per IEC 529

IP 40

Dimensions refer to page 5

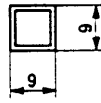
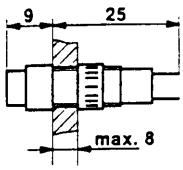

Indicators reduced

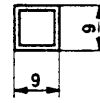
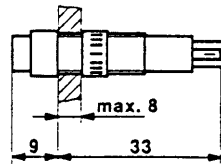

Illuminated pushbuttons with snap-action switching system

Dimensions refer to page 6

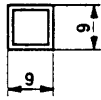
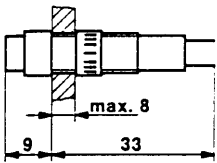

Indicators

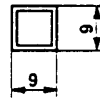
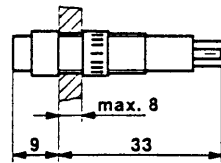

Illuminated pushbuttons with low-level switching system

Mounting dimensions Indicators, illuminated pushbuttons

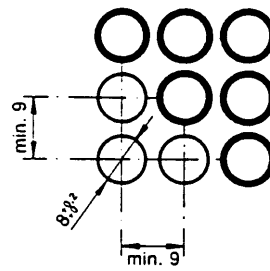
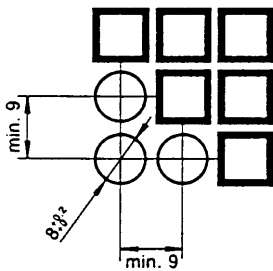

Terminals

Indicator

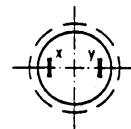
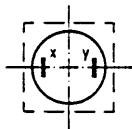

Illuminated pushbutton with snap-action switching system and low-level switching system

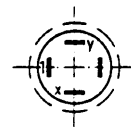
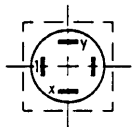

Indicator, Illuminated Pushbuttons with Snap-action Switching System

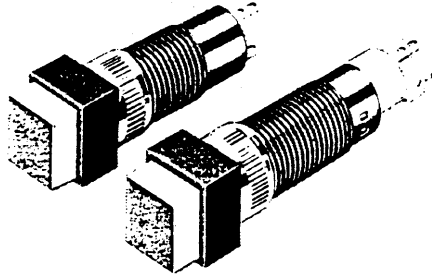

50 VAC/72 VDC, 1A

Dimensions see page 4

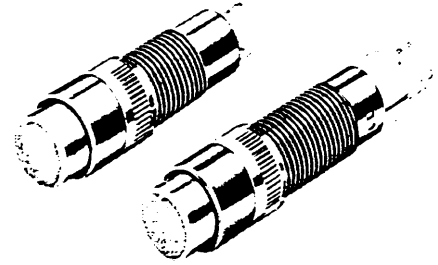

50 VAC/72 VDC, 1A

Order lenses separately
see page 7

□ 9 mm
○ 9 mm

Description	Momentary action	Maintained action		Type No.	Depth mm
Indicator reduced	-	-		□ 19-050.005 ○ 19-030.005	25
Illuminated pushbutton 1 normally open contact silver contact 50 VAC/72 VDC, 1 A	x	-		□ 19-159.015 ○ 19-139.015	33
Illuminated pushbutton 1 normally open contact silver contact 50 VAC/72 VDC, 1 A	-	x		□ 19-289.015 ○ 19-279.015	33
Illuminated pushbutton 1 normally open contact silver, gold-plated 50 VAC/72 VDC, 100 mA	x	-		□ 19-159.035 ○ 19-139.035	33
Illuminated pushbutton 1 normally open contact silver, gold-plated 50 VAC/72 VDC, 100 mA	-	x		□ 19-289.035 ○ 19-279.035	33

Please note our new series 18 with very small depth and compact indicators for direct connection to 2.2, 12 or 24 VDC.

For lamps see page 8

Indicator, Illuminated Pushbuttons with Low-level Switching System

19 LL

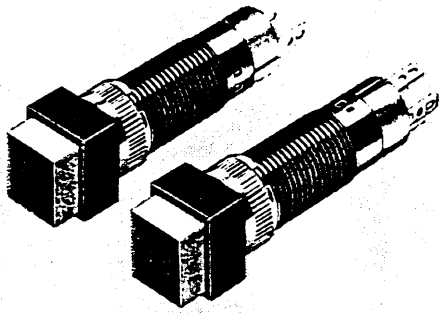

42 VAC/VDC, 100 mA

Dimensions see page 4

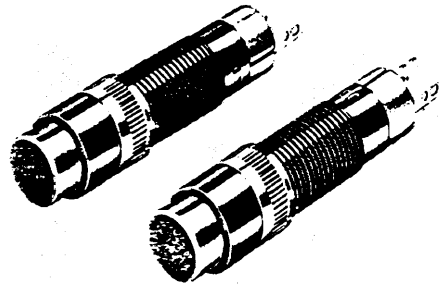









42 VAC/VDC, 100 mA

Order lenses separately see page 7







□ 9 mm



○ 9 mm

Description			Type No.	Depth mm
	Momentary action	Maintained action		
Indicator (The total length is the same as that of the illuminated pushbutton)	-	-	 □19-051.005 ○19-031.005	33
Illuminated pushbutton 1 normally open contact	x	-	  □19-451.035 ○19-431.035	33
Illuminated pushbutton 1 normally closed contact	x	-	  □19-452.035 ○19-432.035	33
Illuminated pushbutton 1 normally open contact	-	x	  □19-481.035 ○19-471.035	33
Illuminated pushbutton 1 normally closed contact	-	x	  □19-482.035 ○19-472.035	33





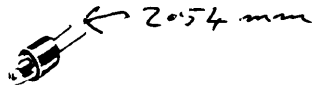
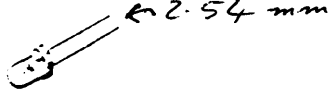

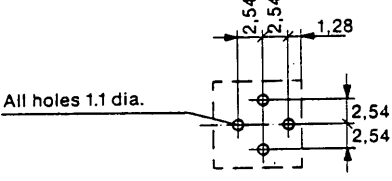
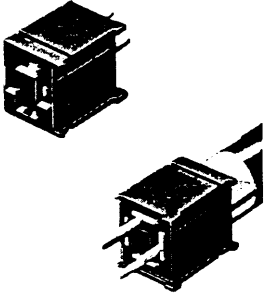
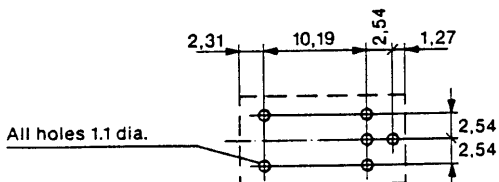
Please note our new series 18 with very small depth and compact indicators for direct connection to 2.2, 12 or 24 VDC.

For lamps see page 8

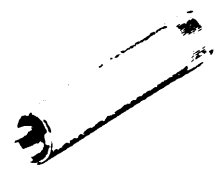
Description	Colour	 7 x 7 mm	 7 mm			
	● opaque	Type No.	Type No.			
Flat, transparent lens with translucent support (for filament lamp and Multi-LED)	● black	19-951.0	19-931.0	 		
	red	19-951.2	19-931.2			
	yellow	19-951.4	19-931.4			
	green	19-951.5	19-931.5			
	blue	19-951.6	19-931.6			
	● grey	19-951.8	19-931.8			
	white	19-951.9	19-931.9			
	Flat, transparent lens with transparent support (for film insert and LED)	red	19-952.2		19-932.2	 
		yellow	19-952.4		19-932.4	
green		19-952.5	19-932.5			
blue		19-952.6	19-932.6			
clear		19-952.7	19-932.7			

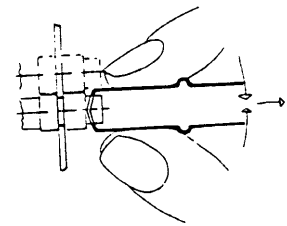
Description	Lamp voltage	Power consumption	Type No.		
Lamp bipin T1 To prevent the casing from being overheated we recommend underrunning the lamp by 20%	6 V 12 V 18 V 24 V 28 V 36 V	117 mA 58 mA 28 mA 25 mA 25 mA 19 mA	19-903.0 19-903.1 19-903.2 19-903.3 19-903.4 19-903.5		
LED bipin T1, 2,2 V Pins 9 mm long		red yellow green	19-943.02 19-943.04 19-943.05		
Multi-LED bipin T1 with built-in series resistor	red orange yellow green	28 V 28 V 28 V 28 V	20 mA 20 mA 15 mA 15 mA	11-968.32 11-968.33 11-968.34 11-968.35	
Axial PCB plug-in base			19-940		
Right-angled PCB plug-in base			19-941		
Flat connector for plug-in terminals 2,0 mm Insulating sleeve for flat connector 31-945			31-945 31-928		

Mounting Tools, Various

Description	Type No.	Image		
Assembly wrench for tightening (or loosening) fixing nuts	19-905			
Lamp remover	11-906			
Dressing tool used as aid to aligning buttons	19-906			
Lens remover	19-910			
Blind plug	square 9 x 9 mm	black	19-948.0	
Blind plug	circular 9 mm dia.	black	19-949.0	
Fixing nut 9 mm dia. x 13 mm Only for sheet < 3 mm thick	19-991			

Данный компонент на территории Российской Федерации

Вы можете приобрести в компании MosChip.

Для оперативного оформления запроса Вам необходимо перейти по данной ссылке:

<http://moschip.ru/get-element>

Вы можете разместить у нас заказ для любого Вашего проекта, будь то серийное производство или разработка единичного прибора.

В нашем ассортименте представлены ведущие мировые производители активных и пассивных электронных компонентов.

Нашей специализацией является поставка электронной компонентной базы двойного назначения, продукции таких производителей как XILINX, Intel (ex.ALTERA), Vicor, Microchip, Texas Instruments, Analog Devices, Mini-Circuits, Amphenol, Glenair.

Сотрудничество с глобальными дистрибьюторами электронных компонентов, предоставляет возможность заказывать и получать с международных складов практически любой перечень компонентов в оптимальные для Вас сроки.

На всех этапах разработки и производства наши партнеры могут получить квалифицированную поддержку опытных инженеров.

Система менеджмента качества компании отвечает требованиям в соответствии с ГОСТ Р ИСО 9001, ГОСТ РВ 0015-002 и ЭС РД 009

Офис по работе с юридическими лицами:

105318, г.Москва, ул.Щербаковская д.3, офис 1107, 1118, ДЦ «Щербаковский»

Телефон: +7 495 668-12-70 (многоканальный)

Факс: +7 495 668-12-70 (доб.304)

E-mail: info@moschip.ru

Skype отдела продаж:

moschip.ru

moschip.ru_4

moschip.ru_6

moschip.ru_9