

## 4A, 400V - 800V Glass Passivated Bridge Rectifier

### FEATURES

- Glass passivated junction
- Ideal for printed circuit board
- High surge current capability
- UL Recognized File # E-326243
- Compliant to RoHS Directive 2011/65/EU and in accordance to WEEE 2002/96/EC

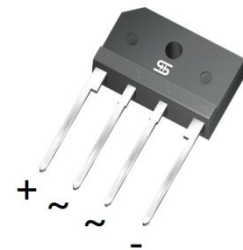
### APPLICATIONS

- Switching mode power supply (SMPS)
- Adapters
- TV
- Monitor

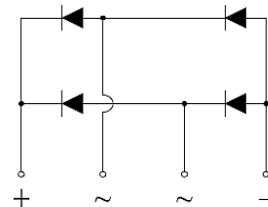
### MECHANICAL DATA

- Case: TS4K
- Molding compound meets UL 94V-0 flammability rating
- Terminal: Matte tin plated leads, solderable per J-STD-002
- Polarity: As marked
- Mounting torque: 0.92 N·m maximum
- Weight: 4.1 g (approximately)

KEY PARAMETERS		
PARAMETER	VALUE	UNIT
$I_F$	4	A
$V_{RRM}$	400 - 800	V
$I_{FSM}$	120	A
$T_{JMAX}$	150	°C
Package	TS4K	
Configuration	Quad	



TS4K



### ABSOLUTE MAXIMUM RATINGS ( $T_A = 25^\circ\text{C}$ unless otherwise noted)

PARAMETER	SYMBOL	TS4K40-A	TS4K60-A	TS4K80-A	UNIT
Marking code on the device		TS4K40	TS4K60	TS4K80	
Repetitive peak reverse voltage	$V_{RRM}$	400	600	800	V
Reverse voltage, total rms value	$V_{R(RMS)}$	280	420	560	V
Forward current	$I_F$	4			A
Surge peak forward current, 8.3 ms single half sine-wave superimposed on rated load	$I_{FSM}$	120			A
Rating of fusing ( $t < 8.3\text{ms}$ )	$I^2t$	60			$\text{A}^2\text{s}$
Junction temperature	$T_J$	- 55 to +150			°C
Storage temperature	$T_{STG}$	- 55 to +150			°C

<b>THERMAL PERFORMANCE</b>			
<b>PARAMETER</b>	<b>SYMBOL</b>	<b>TYP.</b>	<b>UNIT</b>
Junction-to-lead thermal resistance	$R_{\theta JL}$	7	°C/W
Junction-to-ambient thermal resistance	$R_{\theta JA}$	18	°C/W
Junction-to-case thermal resistance	$R_{\theta JC}$	6	°C/W

**Thermal Performance Note:** Mounted on Heat sink Size of 2"x3"x0.25" Al-Plate.

<b>ELECTRICAL SPECIFICATIONS</b> ( $T_A = 25^\circ\text{C}$ unless otherwise noted)					
<b>PARAMETER</b>	<b>CONDITIONS</b>	<b>SYMBOL</b>	<b>TYP.</b>	<b>MAX.</b>	<b>UNIT</b>
Forward voltage per diode <sup>(1)</sup>	$I_F = 2\text{A}, T_J = 25^\circ\text{C}$	$V_F$	-	1.0	V
	$I_F = 2\text{A}, T_J = 125^\circ\text{C}$		-	0.9	V
Reverse current @ rated $V_R$ per diode <sup>(2)</sup>	$T_J = 25^\circ\text{C}$	$I_R$	-	10	$\mu\text{A}$
	$T_J = 125^\circ\text{C}$		-	500	$\mu\text{A}$
Junction capacitance	1 MHz, $V_R = 4.0\text{V}$	$C_J$	42	-	pF

**Notes:**

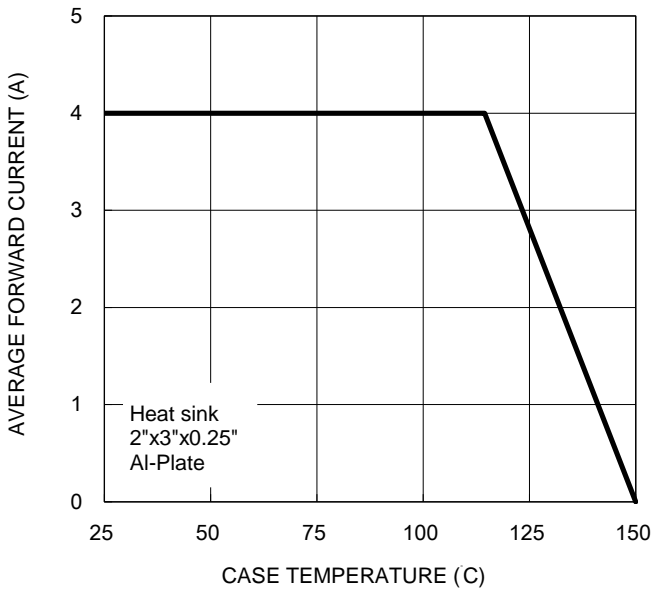
1. Pulse test with  $PW = 0.3\text{ ms}$
2. Pulse test with  $PW = 30\text{ ms}$

<b>ORDERING INFORMATION</b>		
<b>ORDERING CODE</b>	<b>PACKAGE</b>	<b>PACKING</b>
TS4K40-A D3	TS4K	20 / TUBE
TS4K60-A D3	TS4K	20 / TUBE
TS4K80-A D3	TS4K	20 / TUBE

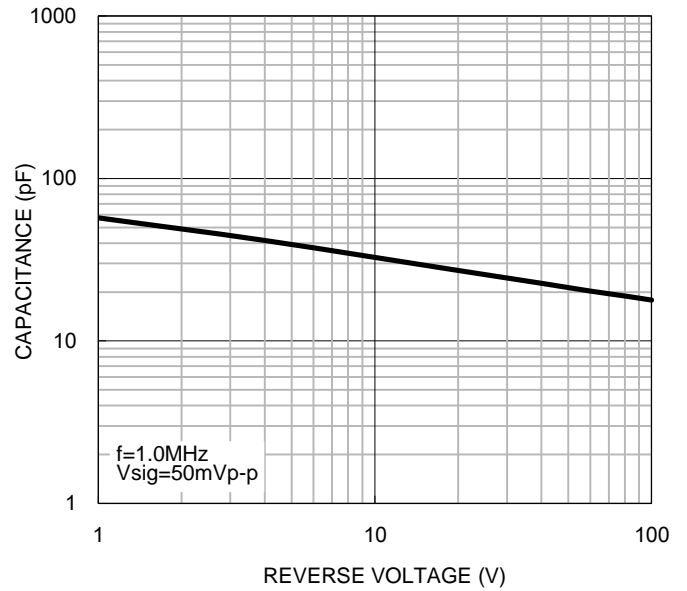
**CHARACTERISTICS CURVES**

( $T_A = 25^\circ\text{C}$  unless otherwise noted)

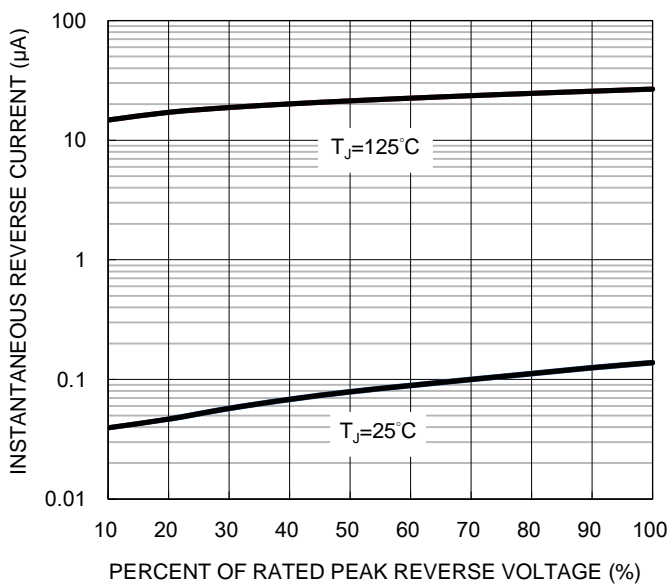
**Fig.1 Forward Current Derating Curve**



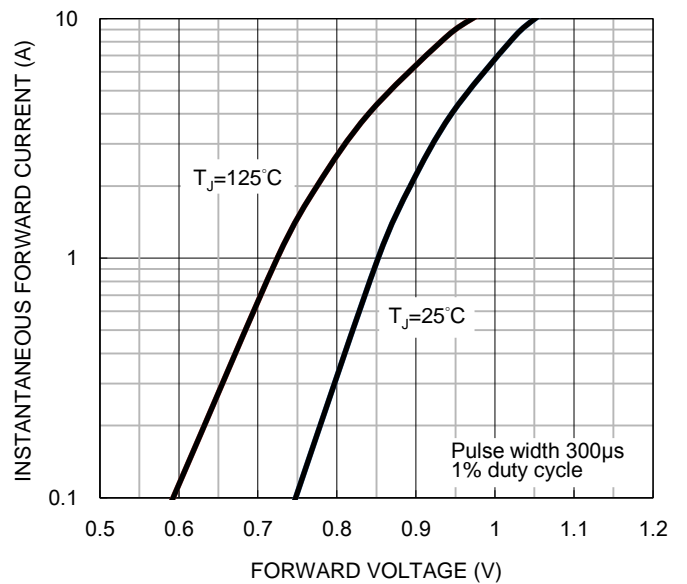
**Fig.2 Typical Junction Capacitance**



**Fig.3 Typical Reverse Characteristics**

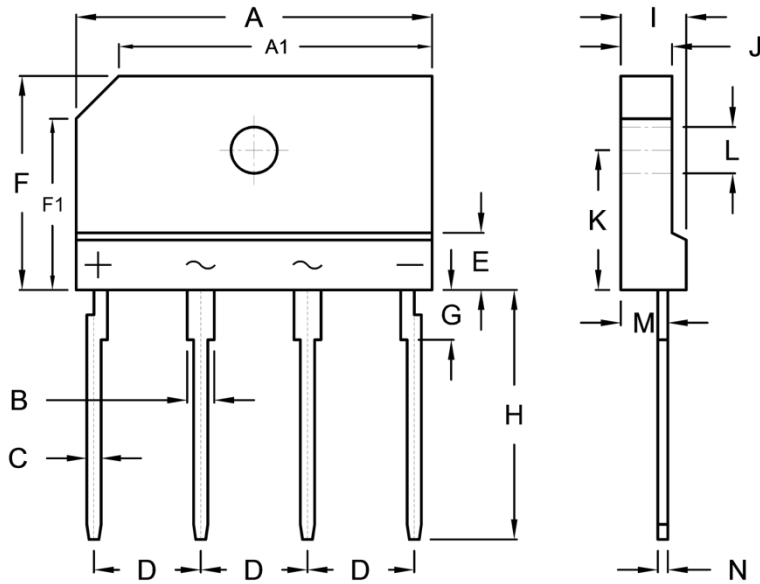


**Fig.4 Typical Forward Characteristics**



**PACKAGE OUTLINE DIMENSIONS**

**TS4K**



DIM.	Unit (mm)		Unit (inch)	
	Min.	Max.	Min.	Max.
A	24.70	25.30	0.972	0.996
A1	21.50	22.50	0.846	0.886
B	1.70	2.10	0.067	0.083
C	0.90	1.10	0.035	0.043
D	7.30	7.70	0.287	0.303
E	3.80	4.20	0.150	0.165
F	14.70	15.30	0.579	0.602
F1	11.50	12.50	0.453	0.492
G	3.30	3.70	0.130	0.146
H	17.00	18.00	0.669	0.709
I	4.40	4.80	0.173	0.189
J	3.40	3.80	0.134	0.150
K	9.50	10.10	0.374	0.398
L	3.10	3.40	0.122	0.134
M	3.20	3.40	0.126	0.134
N	0.60	0.80	0.024	0.031

**MARKING DIAGRAM**



- P/N = Marking Code
- YWW = Date Code
- F = Factory Code

## **Notice**

Specifications of the products displayed herein are subject to change without notice. TSC or anyone on its behalf, assumes no responsibility or liability for any errors or inaccuracies.

Information contained herein is intended to provide a product description only. No license, express or implied, to any intellectual property rights is granted by this document. Except as provided in TSC's terms and conditions of sale for such products, TSC assumes no liability whatsoever, and disclaims any express or implied warranty, relating to sale and/or use of TSC products including liability or warranties relating to fitness for a particular purpose, merchantability, or infringement of any patent, copyright, or other intellectual property right.

The products shown herein are not designed for use in medical, life-saving, or life-sustaining applications. Customers using or selling these products for use in such applications do so at their own risk and agree to fully indemnify TSC for any damages resulting from such improper use or sale.

## Данный компонент на территории Российской Федерации

### Вы можете приобрести в компании MosChip.

Для оперативного оформления запроса Вам необходимо перейти по данной ссылке:

<http://moschip.ru/get-element>

Вы можете разместить у нас заказ для любого Вашего проекта, будь то серийное производство или разработка единичного прибора.

В нашем ассортименте представлены ведущие мировые производители активных и пассивных электронных компонентов.

Нашей специализацией является поставка электронной компонентной базы двойного назначения, продукции таких производителей как XILINX, Intel (ex.ALTERA), Vicor, Microchip, Texas Instruments, Analog Devices, Mini-Circuits, Amphenol, Glenair.

Сотрудничество с глобальными дистрибьюторами электронных компонентов, предоставляет возможность заказывать и получать с международных складов практически любой перечень компонентов в оптимальные для Вас сроки.

На всех этапах разработки и производства наши партнеры могут получить квалифицированную поддержку опытных инженеров.

Система менеджмента качества компании отвечает требованиям в соответствии с ГОСТ Р ИСО 9001, ГОСТ РВ 0015-002 и ЭС РД 009

### Офис по работе с юридическими лицами:

105318, г.Москва, ул.Щербаковская д.3, офис 1107, 1118, ДЦ «Щербаковский»

Телефон: +7 495 668-12-70 (многоканальный)

Факс: +7 495 668-12-70 (доб.304)

E-mail: [info@moschip.ru](mailto:info@moschip.ru)

Skype отдела продаж:

moschip.ru

moschip.ru\_4

moschip.ru\_6

moschip.ru\_9