

# ALPS series LED

## Product Datasheet

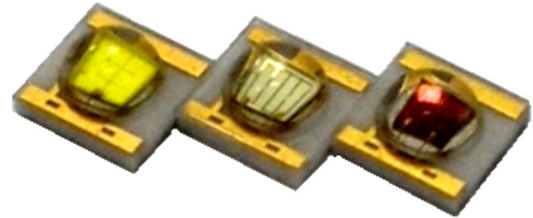

### Description

The Plessey ALPS series is a full colour range of high power, high efficacy LED's in lensed 3535 packages. The domed lens and low thermal resistance packaging ensure high optical output, cool running and optimum reliability. Three lens options are available for each colour type. The ALPS series LED's are supplied in quantities of 1k per reel maximum.

### Features

- Industry standard 3535 footprint
- High optical output
- Full colour range
- High reliability ceramic packaging
- Domed silicone lens
- 55-135deg lens options

### Applications

- General Lighting
- Residential Lighting
- Commercial Lighting
- Street Lighting
- Torches
- Signage
- Displays

Part No.	Colour	CCT / $\lambda_D$ / $\lambda_P^*$		Output @ 350mA	$V_F$		CRI
		min	max		min	max	
PLW3535Ax-C	Cool White	4750K	10000K	139 lm	2.8	3.6	typ 70
PLW3535Ax-N	Neutral White	3700K	4750K	130 lm	2.8	3.6	typ 75
PLW3535Ax-W	Warm White	2600K	3700K	107 lm	2.8	3.6	min 80
PLR3535Ax-S	Super Red	650nm	670nm	280mW	2.0	3.0	
PLR3535Ax	Red	620nm	635nm	56.8 lm	2.0	3.0	
PLA3535Ax	Amber	580nm	600nm	56.8 lm	2.0	3.0	
PLG3535Ax	Green	520nm	535nm	87.4 lm	2.8	3.6	
PLC3535Ax	Cyan	500nm	520nm	80.6 lm	2.8	3.6	
PLB3535Ax-R	Blue	460nm	475nm	30.6 lm	2.8	3.6	
PLB3535Ax-L	Royal Blue	440nm*	460nm*	520mW	2.8	3.6	

## Absolute Maximum Ratings – White, Blue, Royal Blue, Green, Cyan

$T_j = +25^{\circ}\text{C}$  unless otherwise stated

Parameter	Symbol	Min	Max	Unit
DC Forward Current	$I_F$	-	1000	mA
Reverse Voltage	$V_R$	-	5	V
Storage Temperature	$T_{stg}$	-40	125	$^{\circ}\text{C}$
Junction Temperature	$T_J$	-40	150	$^{\circ}\text{C}$

## Absolute Maximum Ratings – Amber, Red, Super Red

$T_j = +25^{\circ}\text{C}$  unless otherwise stated

Parameter	Symbol	Min	Max	Unit
DC Forward Current	$I_F$	-	700	mA
Reverse Voltage	$V_R$	-	5	V
Storage Temperature	$T_{stg}$	-40	125	$^{\circ}\text{C}$
Junction Temperature	$T_J$	-40	125	$^{\circ}\text{C}$

## Primary Electro-optical Characteristics

$I_F = 350\text{mA}$  &  $T_J = 25^{\circ}\text{C}$  unless otherwise stated

Part No.	CCT / $\lambda_D$ / $\lambda_P^*$		Output @ 350mA @700mA			$V_F$	
	min	max	min	max	typ	min	max
PLW3535Ax-C	4750K	10000K	107 lm	148 lm	250 lm	2.8	3.6
PLW3535Ax-N	3700K	4750K	100 lm	139 lm	235 lm	2.8	3.6
PLW3535Ax-W	2600K	3700K	87.4 lm	114 lm	190 lm	2.8	3.6
PLR3535Ax-S	650nm	670nm	240mW	320mW	600mW	2.0	3.0
PLR3535Ax	620nm	635nm	45.7 lm	62 lm	114 lm	2.0	3.0
PLA3535Ax	580nm	600nm	45.7 lm	62 lm	114 lm	2.0	3.0
PLG3535Ax	520nm	535nm	67.2 lm	87.4 lm	135 lm	2.8	3.6
PLC3535Ax	500nm	520nm	62 lm	80.6 lm	125 lm	2.8	3.6
PLB3535Ax-R	460nm	475nm	18 lm	30.6 lm	50 lm	2.8	3.6
PLB3535Ax-L	440nm*	460nm*	400mW	600mW	1020mW	2.8	3.6

## Further Electro-Optical Characteristics

$I_F = 350\text{mA}$  &  $T_J = 25^\circ\text{C}$  unless otherwise stated

Parameter	Symbol	Colours	Value	Unit
V <sub>F</sub> Temperature Coefficient	$\Delta V_F / \Delta T_J$	White, Green, Cyan, Blue, Royal Blue	-2 to -4	mV/°C
		Super Red, Red, Amber	-1 to -2	mV/°C
Thermal Resistance	R <sub>th j-mb</sub>	White, Green, Cyan, Blue, Royal Blue	8	K/W
		Super Red, Red, Amber	10	K/W

## Lens Options

Wide Angle version            125 – 135 deg

Mid Angle version            85 – 90 deg

Narrow Angle version        55 – 65 deg

Name	2 $\Theta_{1/2}$ (deg)	Name	2 $\Theta_{1/2}$ (deg)	Name	2 $\Theta_{1/2}$ (deg)
PLW3535AA-C	130	PLW3535AB-C	90	PLW3535AC-C	65
PLW3535AA-N	130	PLW3535AB-N	90	PLW3535AC-N	65
PLW3535AA-W	130	PLW3535AB-W	90	PLW3535AC-W	65
PLR3535AA-S	125	PLR3535AB-S	85	PLR3535AC-S	55
PLR3535AA	125	PLR3535AB	85	PLR3535AC	55
PLA3535AA	125	PLA3535AB	85	PLA3535AC	55
PLG3535AA	130	PLG3535AB	90	PLG3535AC	65
PLC3535AA	130	PLC3535AB	90	PLC3535AC	65
PLB3535AA-L	130	PLB3535AB-L	90	PLB3535AC-L	65
PLB3535AA-R	130	PLB3535AB-R	90	PLB3535AC-R	65

## Recommended Operating Conditions

In typical applications, for optimum LED performance

Parameter	Symbol	Minimum	Maximum	Unit
Operating Ambient Temperature	T <sub>opr</sub>	-40	+85	°C

## Ordering Information

Name	Luminous Intensity Bins	Wide Angle Order Code	Mid Angle Order Code	Narrow Angle Order Code
PLW3535Ax-C	2C to 7C	PLW3535AAC000	PLW3535ABC000	PLW3535ACC000
PLW3535Ax-N	1C to 6C	PLW3535AAN000	PLW3535ABN000	PLW3535ACN000
PLW3535Ax-W	8B to 3C	PLW3535AAW000	PLW3535ABW000	PLW3535ACW000
PLR3535Ax-S	1M to 3M	PLR3535AAS000	PLR3535ABS000	PLR3535ACS000
PLR3535Ax	1B to 4B	PLR3535AA000	PLR3535AB000	PLR3535AC000
PLA3535Ax	1B to 4B	PLA3535AA000	PLA3535AB000	PLA3535AC000
PLG3535Ax	5B to 8B	PLG3535AA000	PLG3535AB000	PLG3535AC000
PLC3535Ax	4B to 7B	PLC3535AA000	PLC3535AB000	PLC3535AC000
PLB3535Ax-R	1A to 3A	PLB3535AAR000	PLB3535ABR000	PLB3535ACR000
PLB3535Ax-L	5M to 1N	PLB3535AAL000	PLB3535ABL000	PLB3535ACL000

## Radiant Flux Groups

$I_F = 350\text{mA}$ ,  $T_{\text{amb}} = +25^\circ\text{C}$ , unless otherwise stated

Group <sup>[1]</sup>	Luminous Flux $\Phi_v$ (lm)		Group <sup>[1]</sup>	Radiant Power (mW)	
	min	max		min	max
1A	18.0	23.5	1M	240	280
2A	23.5	30.6	2M	280	320
3A	30.6	35.2	3M	320	360
1B	45.7	51.7	4M	360	400
2B	51.7	56.8	5M	400	440
3B	56.8	62.0	6M	440	480
4B	62.0	67.2	7M	480	520
5B	67.2	73.9	8M	520	560
6B	73.9	80.6	9M	560	600
7B	80.6	87.4	1N	600	650
8B	87.4	93.9			
9B	93.9	100			
1C	100	107			
2C	107	114			
3C	114	122			
4C	122	130			
5C	130	139			
6C	139	148			
7C	148	156			

<sup>[1]</sup> Tolerance  $\pm 10\%$

## Forward Voltage Bin Groups

$I_F = 350\text{mA}$ ,  $T_{\text{amb}} = +25^\circ\text{C}$ , unless otherwise stated

Group	$V_F$ <sup>[1]</sup> (V)	
	Min.	Max.
V1	2.0	2.2
V2	2.2	2.4
V3	2.4	2.6
V4	2.6	2.8
V5	2.8	3.0
V6	3.0	3.2
V7	3.2	3.4
V8	3.4	3.6

<sup>[1]</sup> Tolerance  $\pm 0.2\text{V}$

## Wavelength Binning

Colour	Abbreviation.	Min.	Max.
Super Red	SR1	655	665
Red	RE1	620	625
	RE2	625	630
	RE3	630	635
Amber	AM1	585	590
	AM2	590	595
	AM3	595	600
Green	GR1	520	525
	GR2	525	530
	GR3	530	535
Cyan	CY1	500	505
	CY2	505	510
	CY3	510	515
	CY4	515	520
Blue	BL1	460	465
	BL2	465	470
	BL3	470	475
Royal Blue	RB1	440	445
	RB2	445	450
	RB3	450	455
	RB4	455	460

<sup>[1]</sup> Tolerance  $\pm 1\text{nm}$

### Relative Spectral Emission (Typical)

T<sub>j</sub> = 25°C

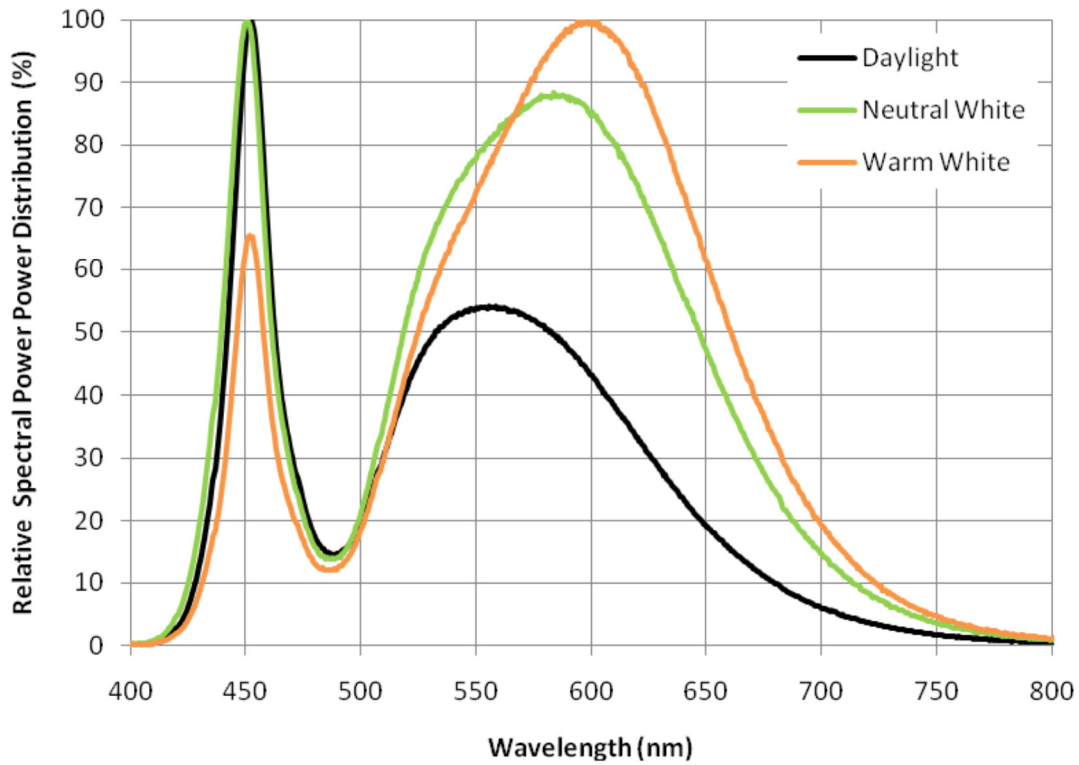

Fig.1 Normalised spectral power distribution – White

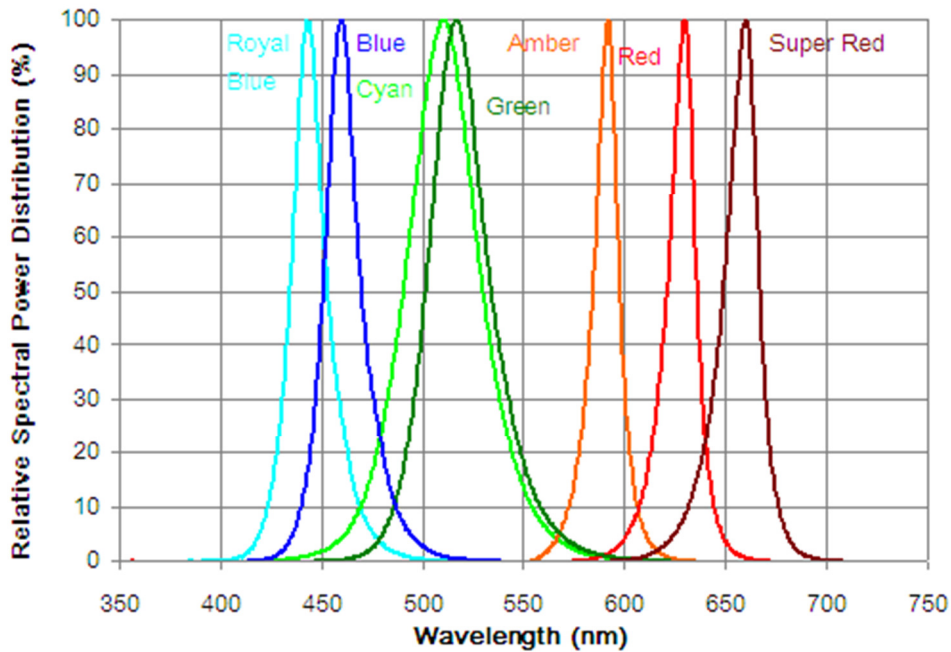

Fig.2 Normalised spectral power distribution – Royal Blue, Blue, Cyan, Green, Amber, Red, Super Red

## Colour Chromaticity – Cool White

Cool White 4750-10000K

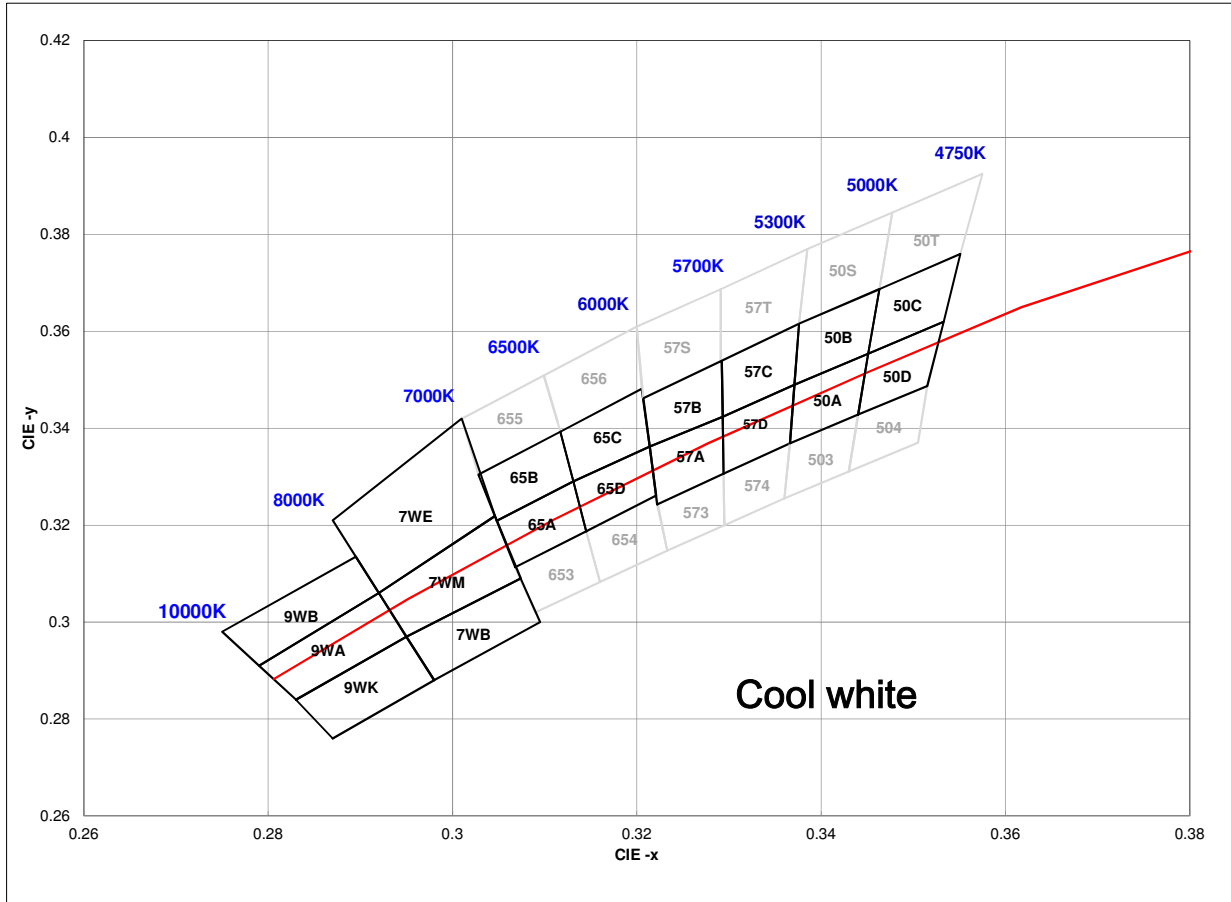

Fig.3A CIE1931 chromaticity diagram (ANSI standard C78.377-2008) – Cool White

# ALPS Series | Product Datasheet

50A		50B		50C		50D		57A		57B		57C		57D	
x	y	x	y	x	y	x	y	x	y	x	y	x	y	x	y
0.367	0.3578	0.3686	0.3649	0.3744	0.3685	0.3726	0.3612	0.3702	0.3722	0.3719	0.3797	0.3782	0.3837	0.3763	0.376
0.3686	0.3649	0.3702	0.3722	0.3763	0.376	0.3744	0.3685	0.3719	0.3797	0.3736	0.3874	0.3802	0.3916	0.3782	0.3837
0.3744	0.3685	0.3763	0.376	0.3825	0.3798	0.3804	0.3721	0.3782	0.3837	0.3802	0.3916	0.3869	0.3958	0.3847	0.3877
0.3726	0.3612	0.3744	0.3685	0.3804	0.3721	0.3783	0.3646	0.3763	0.376	0.3782	0.3837	0.3847	0.3877	0.3825	0.3798
0.367	0.3578	0.3686	0.3649	0.3744	0.3685	0.3726	0.3612	0.3702	0.3722	0.3719	0.3797	0.3782	0.3837	0.3763	0.376
65A		65B		65C		65D									
x	y	x	y	x	y	x	y								
0.3825	0.3798	0.3847	0.3877	0.3912	0.3917	0.3887	0.3836								
0.3847	0.3877	0.3869	0.3958	0.3937	0.4001	0.3912	0.3917								
0.3912	0.3917	0.3937	0.4001	0.4006	0.4044	0.3978	0.3958								
0.3887	0.3836	0.3912	0.3917	0.3978	0.3958	0.395	0.3875								
0.3825	0.3798	0.3847	0.3877	0.3912	0.3917	0.3887	0.3836								
7WB		7WM		7WE		9WK		9WA		9WB					
x	y	x	y	x	y	x	y	x	y	x	y				
0.295	0.297	0.298	0.288	0.292	0.306	0.287	0.276	0.283	0.284	0.2895	0.3135				
0.292	0.306	0.295	0.297	0.287	0.321	0.283	0.284	0.279	0.291	0.275	0.298				
0.3046	0.3219	0.3074	0.309	0.301	0.342	0.295	0.297	0.292	0.306	0.279	0.291				
0.3074	0.309	0.3095	0.3	0.3046	0.3219	0.298	0.288	0.295	0.297	0.292	0.306				
0.295	0.297	0.298	0.288	0.292	0.306	0.287	0.276	0.283	0.284	0.2895	0.3135				
50S		50T		503		504		57S		57T		573		574	
x	y	x	y	x	y	x	y	x	y	x	y	x	y	x	y
0.3376	0.3616	0.3463	0.3687	0.336	0.3255	0.343	0.3311	0.3207	0.3462	0.3291	0.3687	0.3233	0.3148	0.3295	0.32
0.3385	0.377	0.3477	0.3845	0.3366	0.3369	0.344	0.3428	0.32	0.361	0.3291	0.3539	0.3222	0.3243	0.3294	0.3306
0.3477	0.3845	0.3575	0.3925	0.344	0.3428	0.3515	0.3487	0.3291	0.3687	0.3376	0.3616	0.3294	0.3306	0.3366	0.3369
0.3463	0.3687	0.3551	0.376	0.343	0.3311	0.3505	0.337	0.3291	0.3539	0.3385	0.377	0.3295	0.32	0.336	0.3255
0.3376	0.3616	0.3463	0.3687	0.336	0.3255	0.343	0.3311	0.3207	0.3462	0.3291	0.3687	0.3233	0.3148	0.3295	0.32
653		654		655		656									
x	y	x	y	x	y	x	y								
0.309	0.302	0.316	0.3083	0.3028	0.3304	0.3114	0.3414								
0.3068	0.3113	0.3145	0.3187	0.301	0.342	0.3099	0.3509								
0.3145	0.3187	0.3221	0.3261	0.3099	0.3509	0.32	0.361								
0.316	0.3083	0.3233	0.3148	0.3117	0.3393	0.3205	0.3481								
0.309	0.302	0.316	0.3083	0.3028	0.3304	0.3117	0.3393								

[1] Tolerance  $\pm 0.005$

Note: CRI between 68 to 75



## Colour Chromaticity – Neutral White

Neutral White 3700 – 4750K

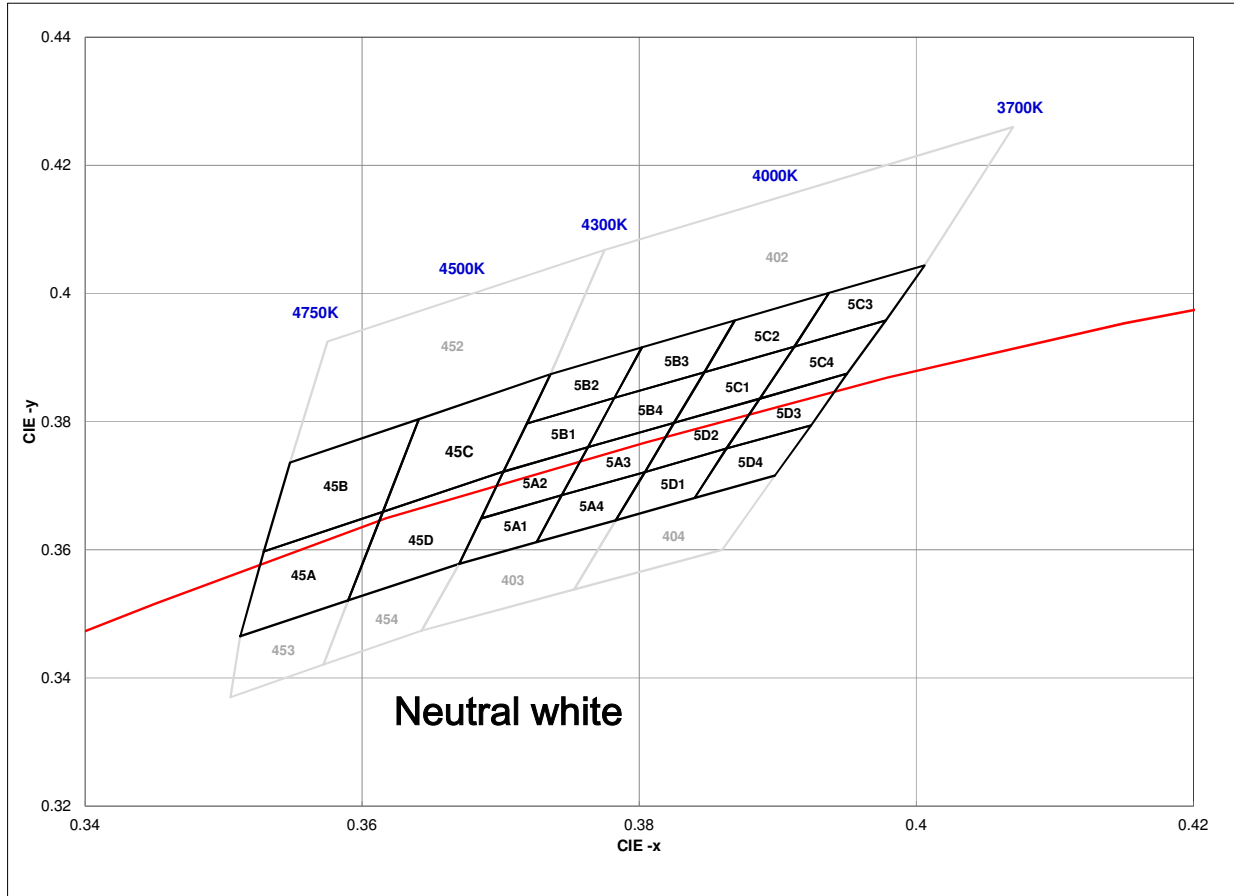

Fig.3B CIE1931 chromaticity diagram (ANSI standard C78.377-2008) – Neutral White

45A		45B		45C		45D									
x	y	x	y	x	y	x	y								
0.3512	0.3465	0.3529	0.3597	0.3615	0.3659	0.359	0.3521								
0.3529	0.3597	0.3548	0.3736	0.3641	0.3804	0.3615	0.3659								
0.3615	0.3659	0.3641	0.3804	0.3736	0.3874	0.3702	0.3722								
0.359	0.3521	0.3615	0.3659	0.3702	0.3722	0.367	0.3578								
0.3512	0.3465	0.3529	0.3597	0.3615	0.3659	0.359	0.3521								
5A1		5A2		5A3		5A4		5B1		5B2		5B3		5B4	
x	y	x	y	x	y	x	y	x	y	x	y	x	y	x	y
0.367	0.3578	0.3686	0.3649	0.3744	0.3685	0.3726	0.3612	0.3702	0.3722	0.3719	0.3797	0.3782	0.3837	0.3763	0.376
0.3686	0.3649	0.3702	0.3722	0.3763	0.376	0.3744	0.3685	0.3719	0.3797	0.3736	0.3874	0.3802	0.3916	0.3782	0.3837
0.3744	0.3685	0.3763	0.376	0.3825	0.3798	0.3804	0.3721	0.3782	0.3837	0.3802	0.3916	0.3869	0.3958	0.3847	0.3877
0.3726	0.3612	0.3744	0.3685	0.3804	0.3721	0.3783	0.3646	0.3763	0.376	0.3782	0.3837	0.3847	0.3877	0.3825	0.3798
0.367	0.3578	0.3686	0.3649	0.3744	0.3685	0.3726	0.3612	0.3702	0.3722	0.3719	0.3797	0.3782	0.3837	0.3763	0.376
5C1		5C2		5C3		5C4		5D1		5D2		5D3		5D4	
x	y	x	y	x	y	x	y	x	y	x	y	x	y	x	y
0.3825	0.3798	0.3847	0.3877	0.3912	0.3917	0.3887	0.3836	0.3783	0.3646	0.3804	0.3721	0.3863	0.3758	0.384	0.3681
0.3847	0.3877	0.3869	0.3958	0.3937	0.4001	0.3912	0.3917	0.3804	0.3721	0.3825	0.3798	0.3887	0.3836	0.3863	0.3758
0.3912	0.3917	0.3937	0.4001	0.4006	0.4044	0.3978	0.3958	0.3863	0.3758	0.3887	0.3836	0.395	0.3875	0.3924	0.3794
0.3887	0.3836	0.3912	0.3917	0.3978	0.3958	0.395	0.3875	0.384	0.3681	0.3863	0.3758	0.3924	0.3794	0.3898	0.3716
0.3825	0.3798	0.3847	0.3877	0.3912	0.3917	0.3887	0.3836	0.3783	0.3646	0.3804	0.3721	0.3863	0.3758	0.384	0.3681
402		403		404		452		453		454					
x	y	x	y	x	y	x	y	x	y	x	y				
0.3736	0.3874	0.3643	0.3474	0.3753	0.3538	0.3548	0.3736	0.3505	0.337	0.3572	0.3421				
0.3775	0.4068	0.367	0.3578	0.3783	0.3646	0.3575	0.3925	0.3512	0.3465	0.359	0.3521				
0.407	0.426	0.3783	0.3646	0.3898	0.3716	0.3775	0.4068	0.359	0.3521	0.367	0.3578				
0.4006	0.4044	0.3753	0.3538	0.386	0.36	0.3736	0.3874	0.3572	0.3421	0.3643	0.3474				
0.3736	0.3874	0.3643	0.3474	0.3753	0.3538	0.3548	0.3736	0.3505	0.337	0.3572	0.3421				

[1] Tolerance ±0.005. Note: CRI between 70 to 78

## Colour Chromaticity – Warm White

Warm White 2600 – 3700K

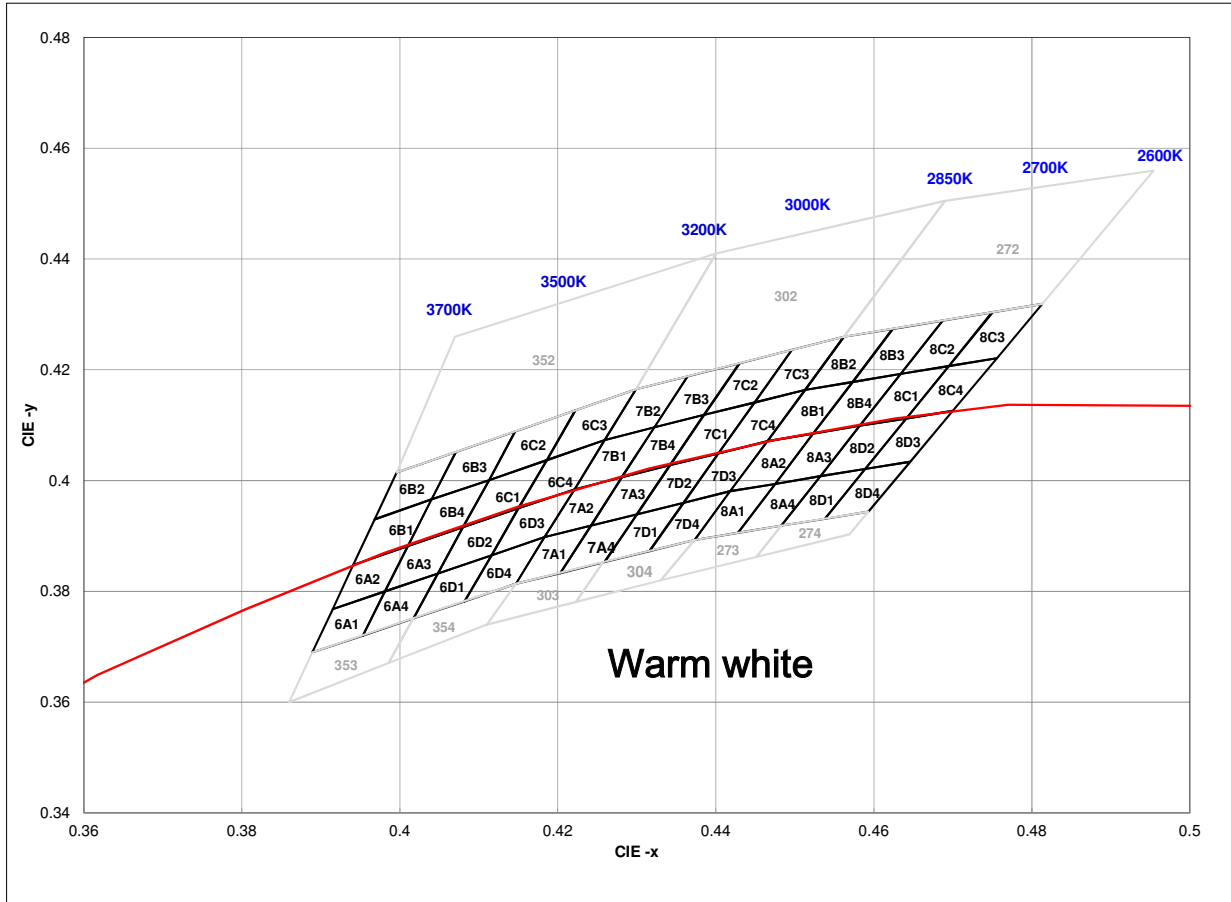

Fig.3C CIE1931 chromaticity diagram (ANSI standard C78.377-2008) – Warm White

6A1		6A2		6A3		6A4		6B1		6B2		6B3		6B4	
x	y	x	y	x	y	x	y	x	y	x	y	x	y	x	y
0.3889	0.3690	0.3915	0.3768	0.3981	0.3800	0.3953	0.3720	0.3941	0.3848	0.3968	0.3930	0.4040	0.3966	0.4010	0.3882
0.3915	0.3768	0.3941	0.3848	0.4010	0.3882	0.3981	0.3800	0.3968	0.3930	0.3996	0.4015	0.4071	0.4052	0.4040	0.3966
0.3981	0.3800	0.4010	0.3882	0.4080	0.3916	0.4048	0.3832	0.4040	0.3966	0.4071	0.4052	0.4146	0.4089	0.4113	0.4001
0.3953	0.3720	0.3981	0.3800	0.4048	0.3832	0.4017	0.3751	0.4010	0.3882	0.4040	0.3966	0.4113	0.4001	0.4080	0.3916
0.3889	0.3690	0.3915	0.3768	0.3981	0.3800	0.3953	0.3720	0.3941	0.3848	0.3968	0.3930	0.4040	0.3966	0.4010	0.3882
6C1		6C2		6C3		6C4		6D1		6D2		6D3		6D4	
x	y	x	y	x	y	x	y	x	y	x	y	x	y	x	y
0.4080	0.3916	0.4113	0.4001	0.4186	0.4037	0.4150	0.3950	0.4017	0.3751	0.4048	0.3832	0.4116	0.3865	0.4082	0.3782
0.4113	0.4001	0.4146	0.4089	0.4222	0.4127	0.4186	0.4037	0.4048	0.3832	0.4080	0.3916	0.4150	0.3950	0.4116	0.3865
0.4186	0.4037	0.4222	0.4127	0.4299	0.4165	0.4259	0.4073	0.4116	0.3865	0.4150	0.3950	0.4221	0.3984	0.4183	0.3898
0.4150	0.3950	0.4186	0.4037	0.4259	0.4073	0.4221	0.3984	0.4082	0.3782	0.4116	0.3865	0.4183	0.3898	0.4147	0.3814
0.4080	0.3916	0.4113	0.4001	0.4186	0.4037	0.4150	0.3950	0.4017	0.3751	0.4048	0.3832	0.4116	0.3865	0.4082	0.3782
7A1		7A2		7A3		7A4		7B1		7B2		7B3		7B4	
x	y	x	y	x	y	x	y	x	y	x	y	x	y	x	y
0.4147	0.3814	0.4183	0.3898	0.4242	0.3919	0.4203	0.3833	0.4221	0.3984	0.4259	0.4073	0.4322	0.4096	0.4281	0.4006
0.4183	0.3898	0.4221	0.3984	0.4281	0.4006	0.4242	0.3919	0.4259	0.4073	0.4299	0.4165	0.4364	0.4188	0.4322	0.4096
0.4242	0.3919	0.4281	0.4006	0.4342	0.4028	0.4300	0.3939	0.4322	0.4096	0.4364	0.4188	0.4430	0.4212	0.4385	0.4119
0.4203	0.3833	0.4242	0.3919	0.4300	0.3939	0.4259	0.3853	0.4281	0.4006	0.4322	0.4096	0.4385	0.4119	0.4342	0.4028
0.4147	0.3814	0.4183	0.3898	0.4242	0.3919	0.4203	0.3833	0.4221	0.3984	0.4259	0.4073	0.4322	0.4096	0.4281	0.4006
7C1		7C2		7C3		7C4		7D1		7D2		7D3		7D4	
x	y	x	y	x	y	x	y	x	y	x	y	x	y	x	y
0.4342	0.4028	0.4385	0.4119	0.4449	0.4141	0.4403	0.4049	0.4259	0.3853	0.4300	0.3939	0.4342	0.4028	0.4403	0.4049
0.4385	0.4119	0.4430	0.4212	0.4496	0.4236	0.4449	0.4141	0.4300	0.3939	0.4342	0.4028	0.4403	0.4049	0.4359	0.3960
0.4449	0.4141	0.4496	0.4236	0.4562	0.4260	0.4513	0.4164	0.4359	0.3960	0.4403	0.4049	0.4465	0.4071	0.4418	0.3981
0.4403	0.4049	0.4449	0.4141	0.4513	0.4164	0.4465	0.4071	0.4316	0.3873	0.4359	0.3960	0.4418	0.3981	0.4373	0.3893
0.4342	0.4028	0.4385	0.4119	0.4449	0.4141	0.4403	0.4049	0.4259	0.3853	0.4300	0.3939	0.4342	0.4028	0.4403	0.4049
8A1		8A2		8A3		8A4		8B1		8B2		8B3		8B4	
x	y	x	y	x	y	x	y	x	y	x	y	x	y	x	y
0.4373	0.3893	0.4418	0.3981	0.4475	0.3994	0.4428	0.3906	0.4465	0.4071	0.4513	0.4164	0.4573	0.4178	0.4523	0.4085
0.4418	0.3981	0.4465	0.4071	0.4523	0.4085	0.4475	0.3994	0.4513	0.4164	0.4562	0.4260	0.4624	0.4274	0.4573	0.4178
0.4475	0.3994	0.4523	0.4085	0.4582	0.4099	0.4532	0.4008	0.4573	0.4178	0.4624	0.4274	0.4687	0.4289	0.4634	0.4193
0.4428	0.3906	0.4475	0.3994	0.4532	0.4008	0.4483	0.3919	0.4523	0.4085	0.4573	0.4178	0.4634	0.4193	0.4582	0.4099
0.4373	0.3893	0.4418	0.3981	0.4475	0.3994	0.4428	0.3906	0.4465	0.4071	0.4513	0.4164	0.4573	0.4178	0.4523	0.4085
8C1		8C2		8C3		8C4		8D1		8D2		8D3		8D4	
x	y	x	y	x	y	x	y	x	y	x	y	x	y	x	y
0.4582	0.4099	0.4634	0.4193	0.4695	0.4207	0.4641	0.4112	0.4483	0.3919	0.4532	0.4008	0.4589	0.4021	0.4538	0.3931
0.4634	0.4193	0.4687	0.4289	0.4750	0.4304	0.4695	0.4207	0.4532	0.4008	0.4582	0.4099	0.4641	0.4112	0.4589	0.4021
0.4695	0.4207	0.4750	0.4304	0.4813	0.4319	0.4756	0.4221	0.4589	0.4021	0.4641	0.4112	0.4700	0.4126	0.4646	0.4034
0.4641	0.4112	0.4695	0.4207	0.4756	0.4221	0.4700	0.4126	0.4538	0.3931	0.4589	0.4021	0.4646	0.4034	0.4593	0.3944
0.4582	0.4099	0.4634	0.4193	0.4695	0.4207	0.4641	0.4112	0.4483	0.3919	0.4532	0.4008	0.4589	0.4021	0.4538	0.3931

272		273		274	
x	y	x	y	x	y
0.4562	0.4260	0.4330	0.3820	0.4451	0.3862
0.4690	0.4505	0.4373	0.3893	0.4483	0.3919
0.4954	0.4560	0.4483	0.3919	0.4593	0.3944
0.4813	0.4319	0.4451	0.3862	0.4569	0.3903
0.4562	0.4260	0.4330	0.3820	0.4451	0.3862
302		303		304	
x	y	x	y	x	y
0.4299	0.4165	0.4110	0.3740	0.4223	0.3781
0.4400	0.4410	0.4147	0.3814	0.4257	0.3853
0.4690	0.4505	0.4257	0.3853	0.4373	0.3893
0.4562	0.4260	0.4223	0.3781	0.4330	0.3820
0.4299	0.4165	0.4110	0.3740	0.4223	0.3781
352		353		354	
x	y	x	y	x	y
0.3996	0.4015	0.3860	0.3600	0.3986	0.3671
0.4070	0.4260	0.3889	0.3690	0.4017	0.3752
0.4400	0.4410	0.4017	0.3752	0.4147	0.3814
0.4299	0.4165	0.3986	0.3671	0.4110	0.3740
0.3996	0.4015	0.3860	0.3600	0.3986	0.3671

[1] Tolerance ±0.005

Note: CRI between 80 to 88

### Angular Light Distribution

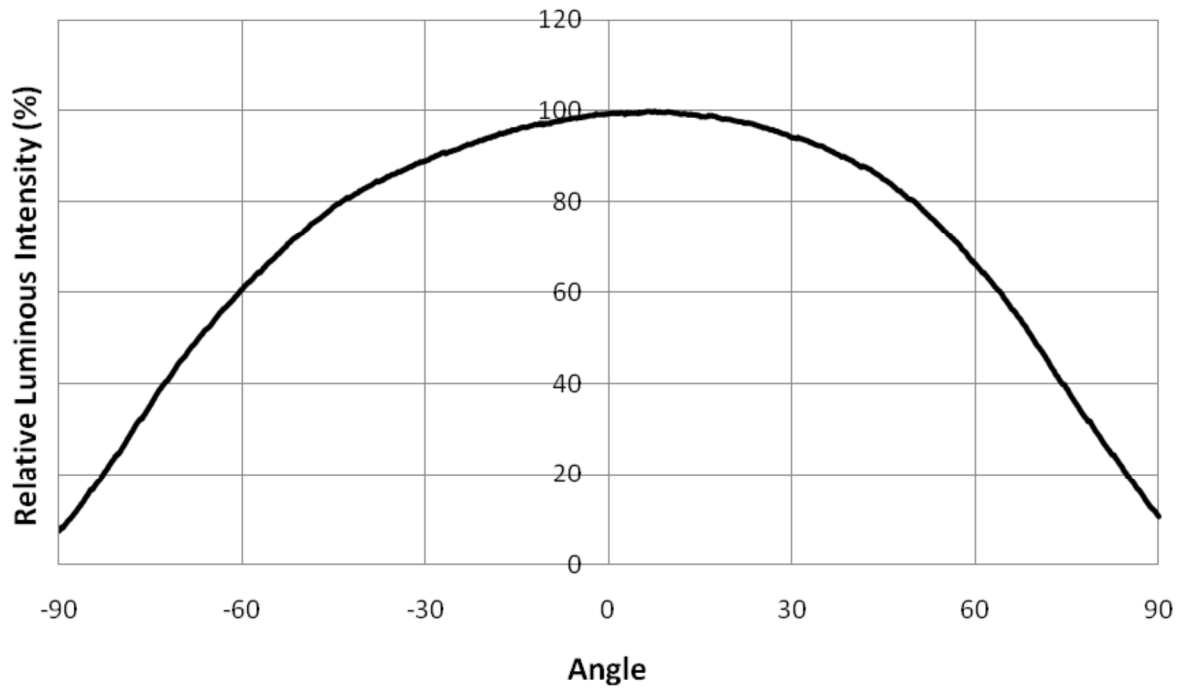

Fig.4 Angular distribution pattern of emitted light (typical) – Cool White

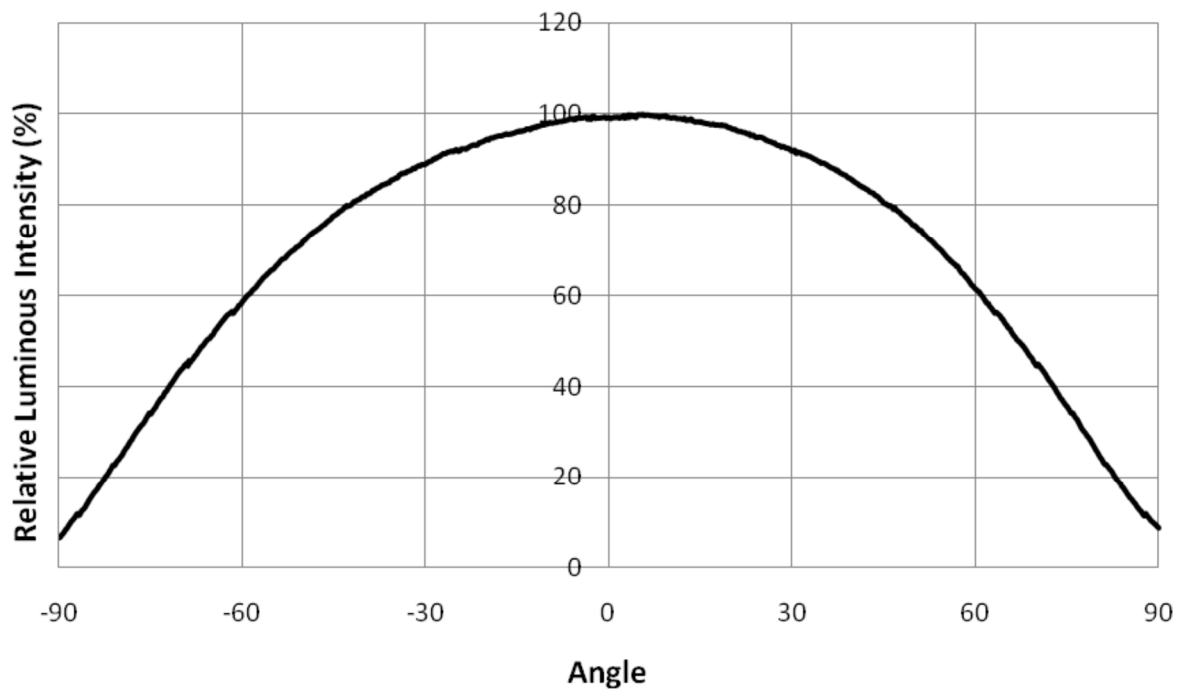

Fig.5 Angular distribution pattern of emitted light (typical) – Neutral White

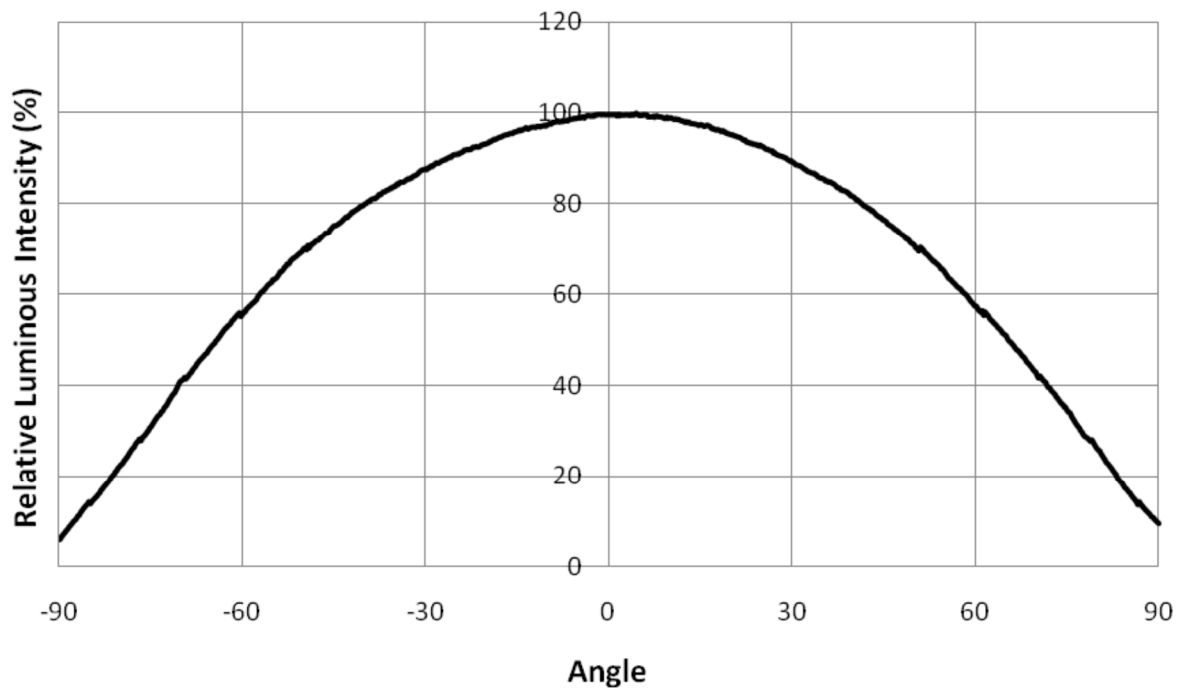

Fig.6 Angular distribution pattern of emitted light (typical) – Warm White

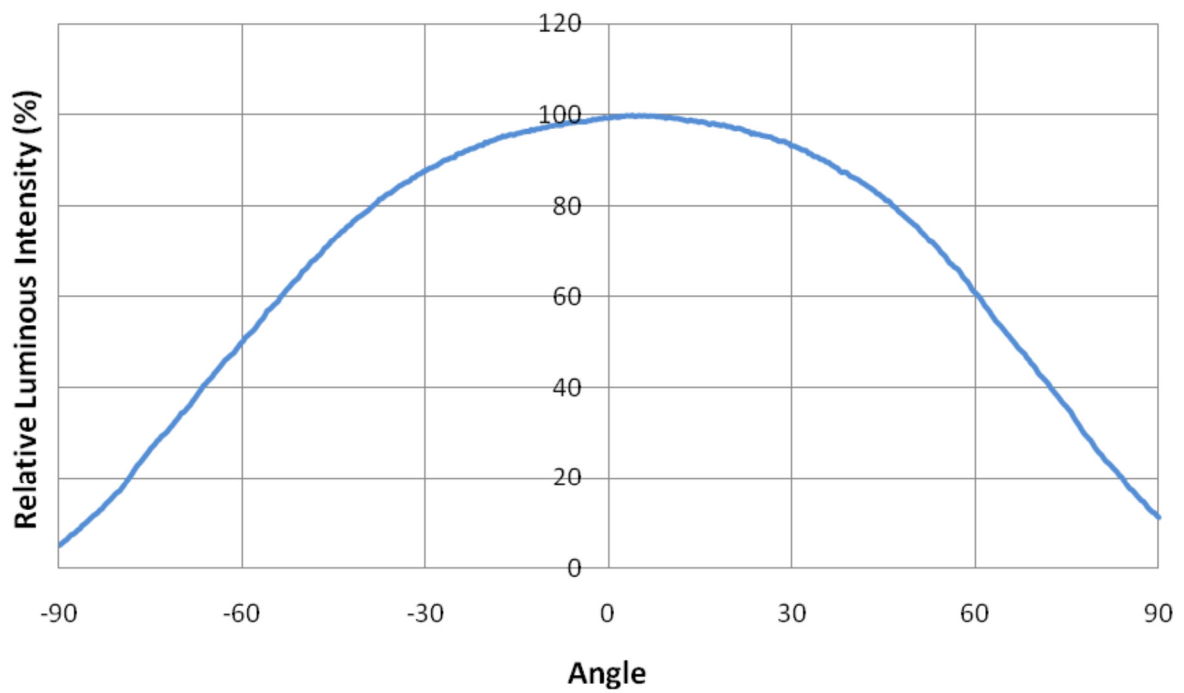

Fig.7 Angular distribution pattern of emitted light (typical) – Blue, Royal Blue

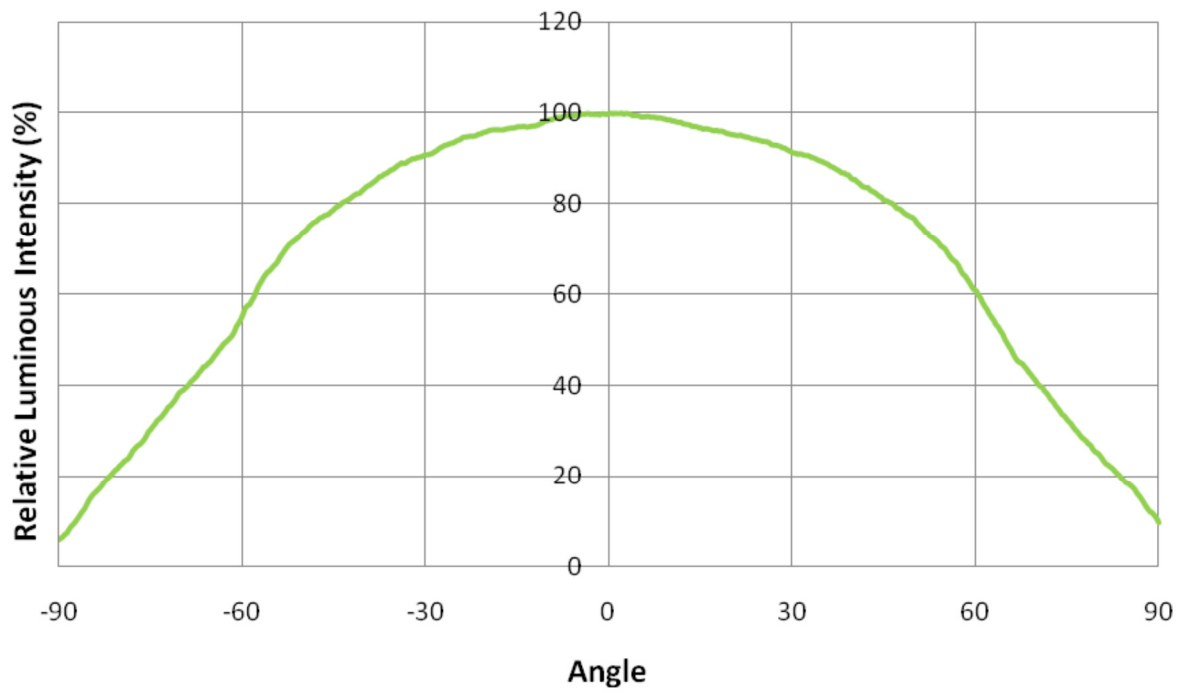

Fig.8 Angular distribution pattern of emitted light (typical) – Green, Cyan

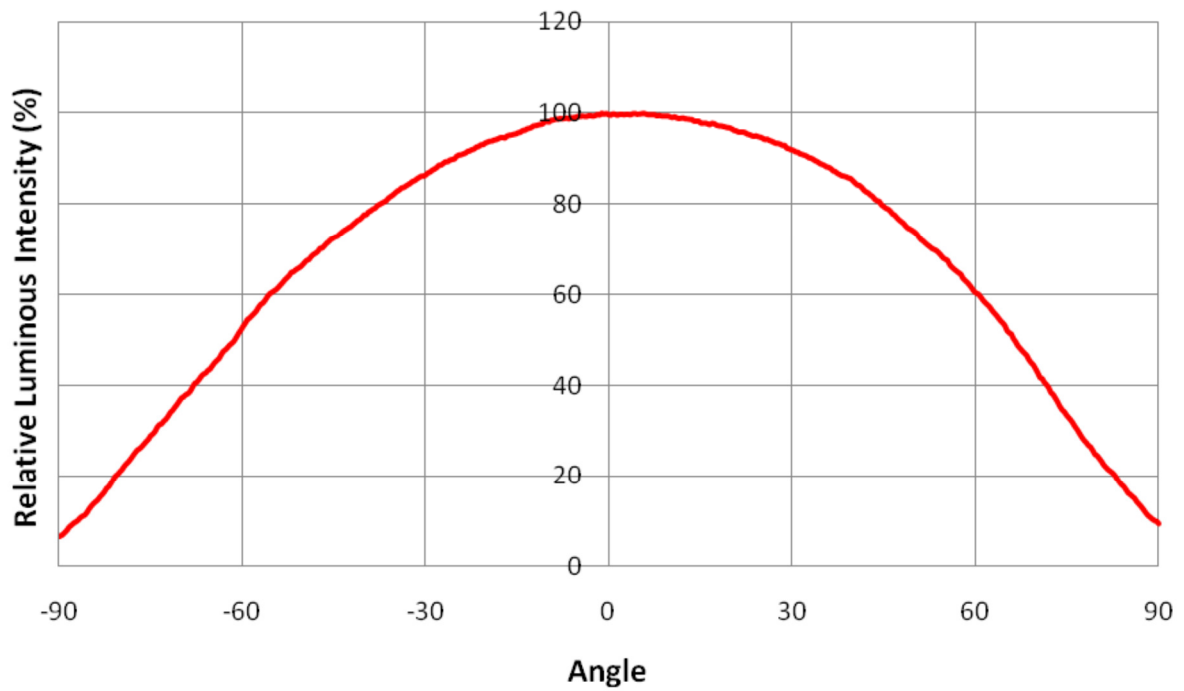

Fig.9 Angular distribution pattern of emitted light (typical) – Amber, Red, Super Red

### Forward Current Characteristics

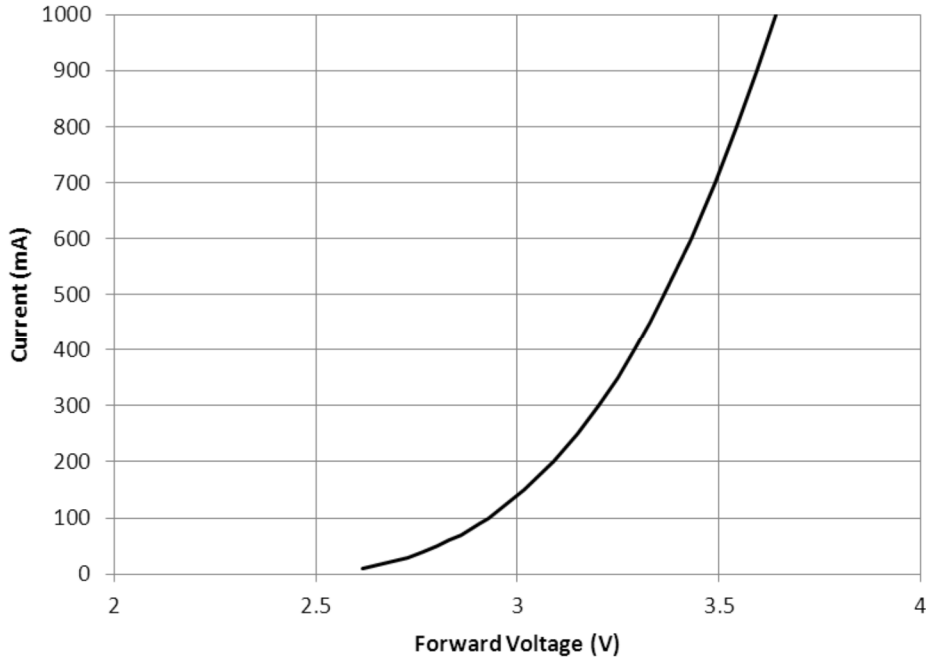

Fig.10 Typ forward voltage vs forward current – White, Blue, Royal Blue, Green, Cyan

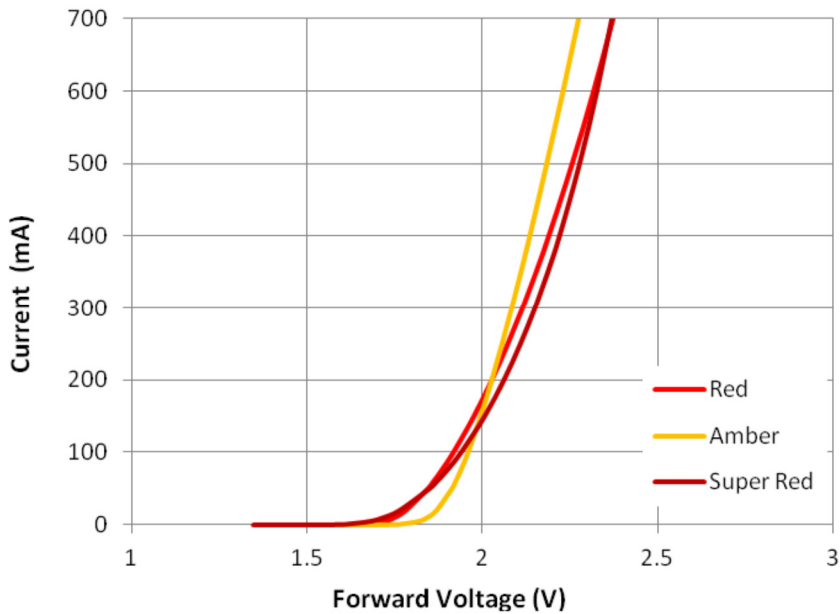

Fig.11 Typ forward voltage vs forward current – Amber, Red, Super Red

### Temperature Characteristics

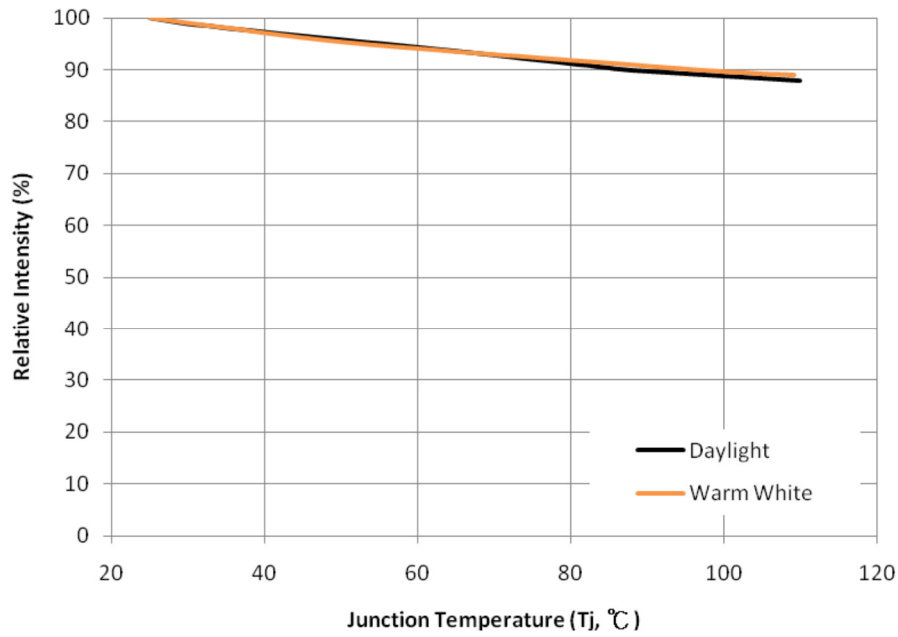

Fig.12 Relative luminous flux vs junction temperature - White

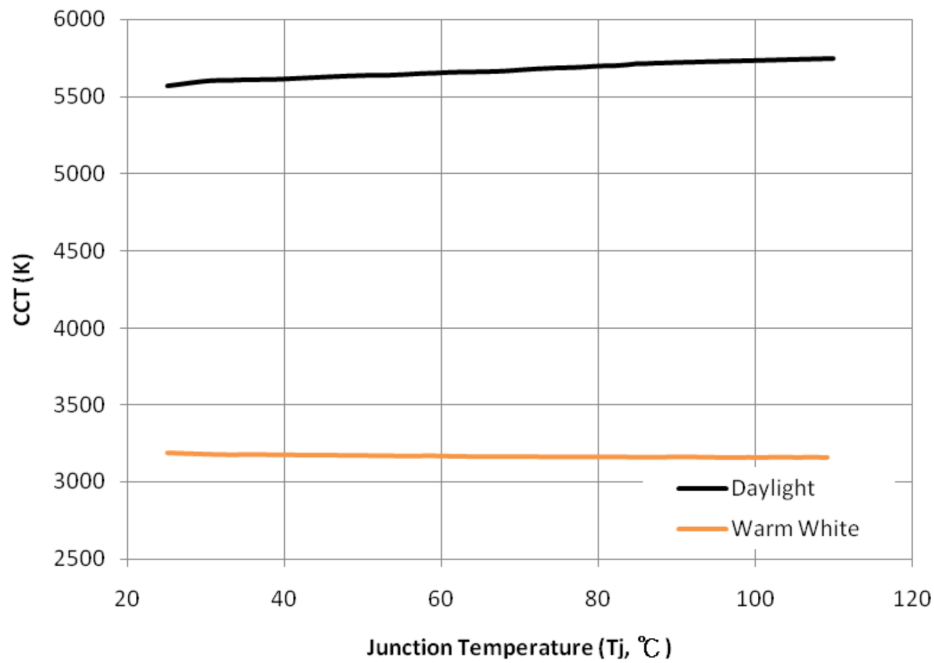

Fig.13 CCT vs junction temperature - White



## Derating Curves

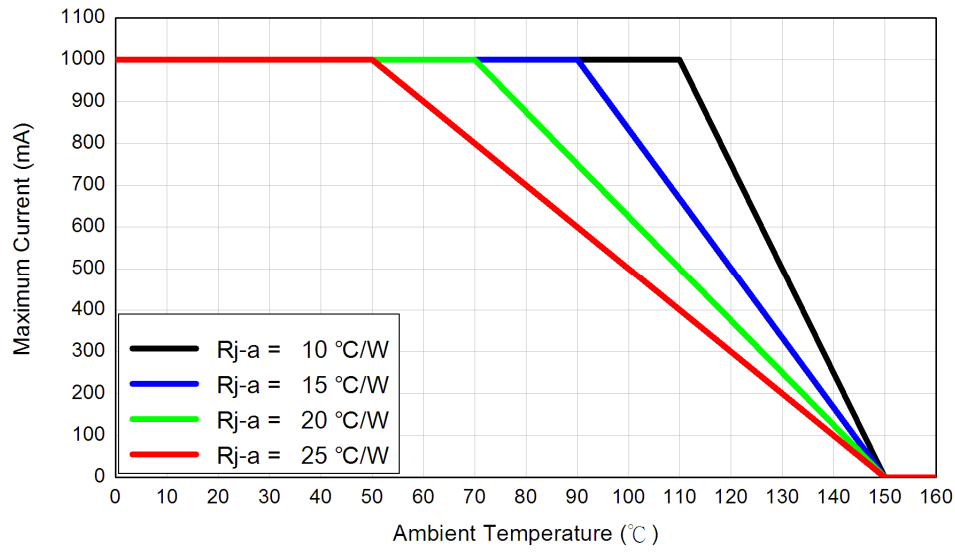

Fig.14 Ambient Temperature Derating Curve – White, Blue, Royal Blue, Green, Cyan

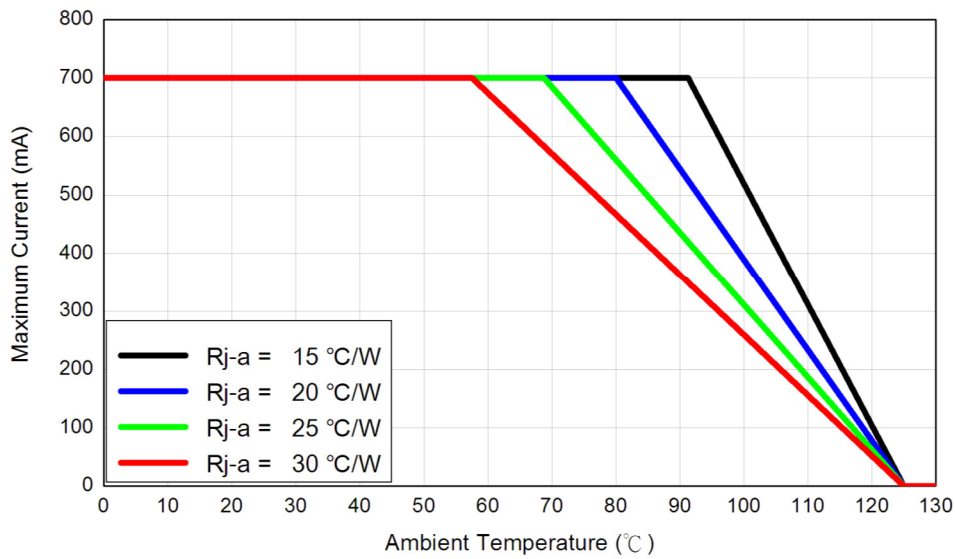

Fig.15 Ambient Temperature Derating Curve – Amber, Red, Super Red

## Package Outline Dimensions

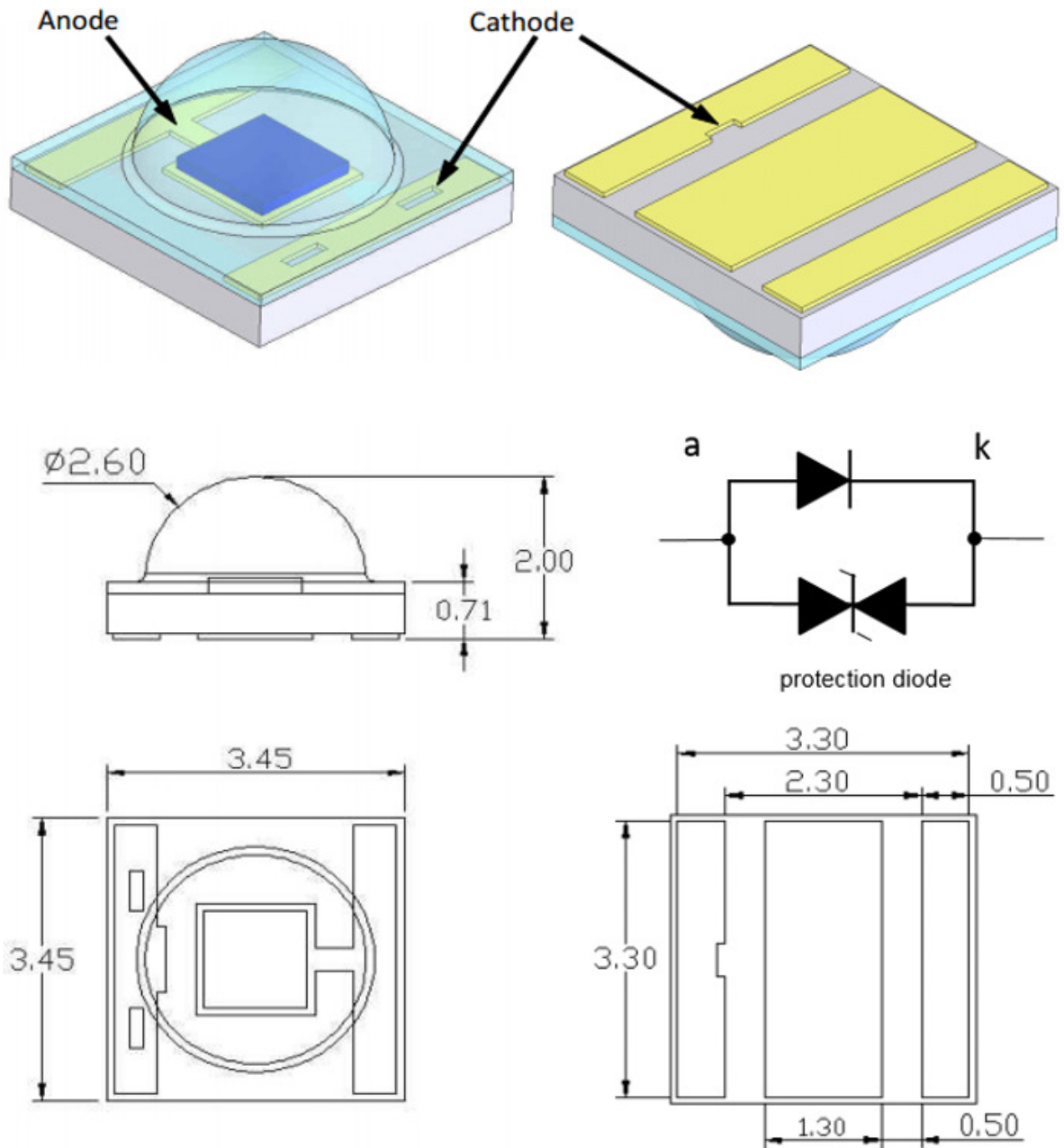

Fig.16 Mechanical drawings of the 3535 package

Notes:

1. All dimensions are in mm
2. All dimensions are to a tolerance of  $\pm 0.13\text{mm}$

## Handling Instructions

Plessey LEDs are not designed to operate with reverse bias.

Precautions are required to prevent reverse bias in applications and during handling.

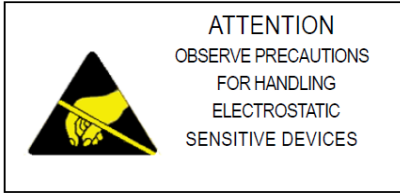

Moisture Sensitivity

JEDEC Level	Floor life		Bake	
	Time	Conditions	Time	Conditions
1	unlimited	≤+30°C / 85% RH	Not required	-

Soldering Information

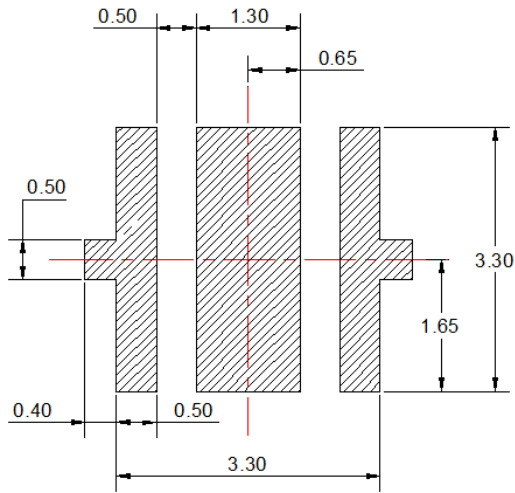

Fig.17 Recommended Solder Pad Design

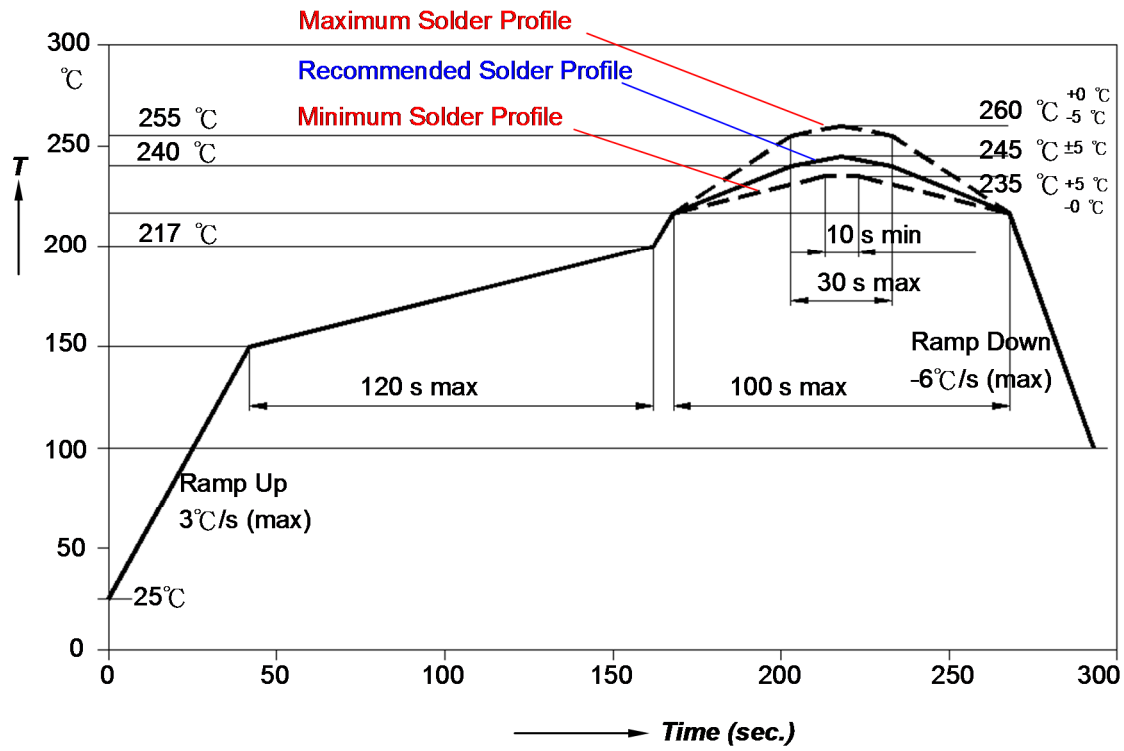
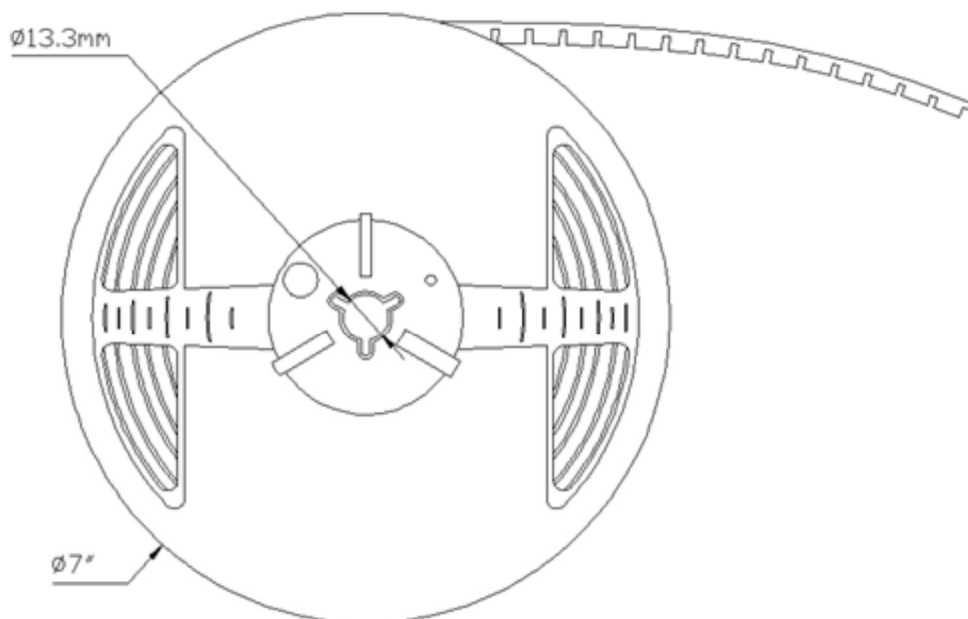
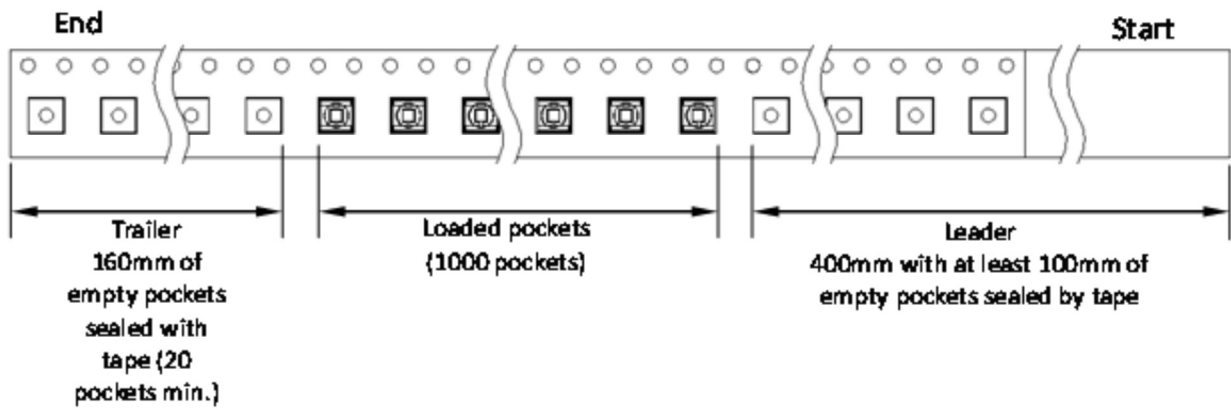
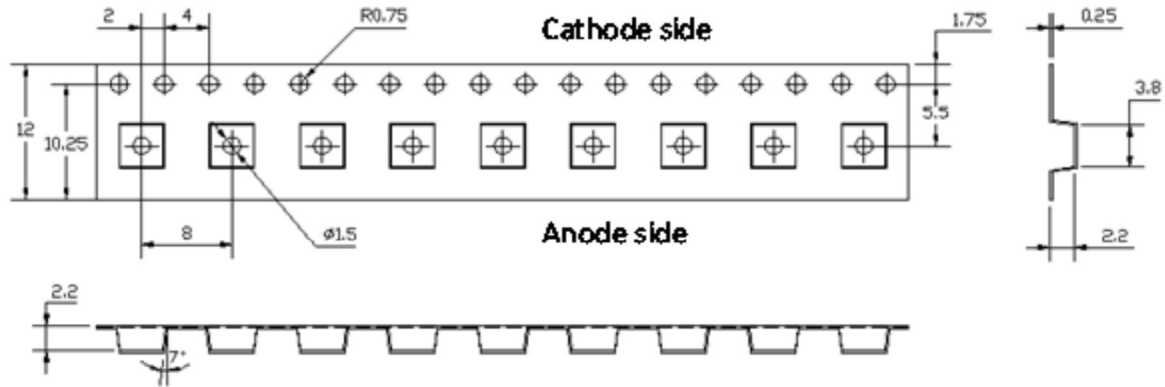

Fig.18 Recommended Solder Profile

## Packing Information

The carrier tape conform to EIA-481D.



## Legal Notice

Product information provided by Plessey Semiconductors Limited (“Plessey”) in this document is believed to be correct and accurate. Plessey reserves the right to change/correct the specifications and other data or information relating to products without notice but Plessey accepts no liability for errors that may appear in this document, howsoever occurring, or liability arising from the use or application of any information or data provided herein. Neither the supply of such information, nor the purchase or use of products conveys any licence or permission under patent, copyright, trademark or other intellectual property right of Plessey or third parties.

Products sold by Plessey are subject to its standard Terms and Conditions of Sale that are available on request. No warranty is given that products do not infringe the intellectual property rights of third parties, and furthermore, the use of products in certain ways or in combination with Plessey, or non-Plessey furnished equipments/components may infringe intellectual property rights of Plessey.

The purpose of this document is to provide information only and it may not be used, applied or reproduced (in whole or in part) for any purpose nor be taken as a representation relating to the products in question. No warranty or guarantee express or implied is made concerning the capability, performance or suitability of any product, and information concerning possible applications or methods of use is provided for guidance only and not as a recommendation. The user is solely responsible for determining the performance and suitability of the product in any application and checking that any specification or data it seeks to rely on has not been superseded.

Products are intended for normal commercial applications. For applications requiring unusual environmental requirements, extended temperature range, or high reliability capability (e.g. military, or medical applications), special processing/testing/conditions of sale may be available on application to Plessey.

## Contact

Customer Support

+44 1752 693000 | [support@plesseysemi.com](mailto:support@plesseysemi.com)

[www.plesseysemi.com](http://www.plesseysemi.com)

Plessey Semiconductors Ltd | Plymouth  
Tamerton Road, Roborough  
Plymouth, Devon  
PL6 7BQ United Kingdom

Plessey Semiconductors Ltd | Swindon  
Design & Technology Centre, Delta  
500, Delta Business Park, Swindon  
SN5 7XE United Kingdom

P: +44 1752 693000  
F: +44 1752 693700

P: +44 1793 518000  
F: +44 1793 518030

## Данный компонент на территории Российской Федерации

### Вы можете приобрести в компании MosChip.

Для оперативного оформления запроса Вам необходимо перейти по данной ссылке:

<http://moschip.ru/get-element>

Вы можете разместить у нас заказ для любого Вашего проекта, будь то серийное производство или разработка единичного прибора.

В нашем ассортименте представлены ведущие мировые производители активных и пассивных электронных компонентов.

Нашей специализацией является поставка электронной компонентной базы двойного назначения, продукции таких производителей как XILINX, Intel (ex.ALTERA), Vicor, Microchip, Texas Instruments, Analog Devices, Mini-Circuits, Amphenol, Glenair.

Сотрудничество с глобальными дистрибьюторами электронных компонентов, предоставляет возможность заказывать и получать с международных складов практически любой перечень компонентов в оптимальные для Вас сроки.

На всех этапах разработки и производства наши партнеры могут получить квалифицированную поддержку опытных инженеров.

Система менеджмента качества компании отвечает требованиям в соответствии с ГОСТ Р ИСО 9001, ГОСТ РВ 0015-002 и ЭС РД 009

### Офис по работе с юридическими лицами:

105318, г.Москва, ул.Щербаковская д.3, офис 1107, 1118, ДЦ «Щербаковский»

Телефон: +7 495 668-12-70 (многоканальный)

Факс: +7 495 668-12-70 (доб.304)

E-mail: [info@moschip.ru](mailto:info@moschip.ru)

Skype отдела продаж:

moschip.ru

moschip.ru\_4

moschip.ru\_6

moschip.ru\_9