

RF Power LDMOS Transistor

N-Channel Enhancement-Mode Lateral MOSFET

This 28 W asymmetrical Doherty RF power LDMOS transistor is designed for cellular base station applications covering the frequency range of 1805 to 1880 MHz.

1800 MHz

- Typical Doherty Single-Carrier W-CDMA Performance: $V_{DD} = 28$ Vdc, $I_{DQA} = 400$ mA, $V_{GSB} = 0.65$ Vdc, $P_{out} = 28$ W Avg., Input Signal PAR = 9.9 dB @ 0.01% Probability on CCDF.

Frequency	G_{ps} (dB)	η_D (%)	Output PAR (dB)	ACPR (dBc)
1805 MHz	17.9	49.9	7.7	-32.0
1840 MHz	17.8	49.3	7.7	-33.8
1880 MHz	17.8	50.2	7.8	-34.7

Features

- Advanced High Performance In-Package Doherty
- Greater Negative Gate-Source Voltage Range for Improved Class C Operation
- Designed for Digital Predistortion Error Correction Systems

A2T18H160-24SR3

1805–1880 MHz, 28 W AVG., 28 V
AIRFAST RF POWER LDMOS
TRANSISTOR

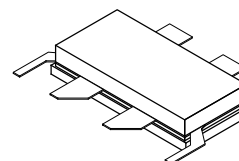

NI-780S-4L2L

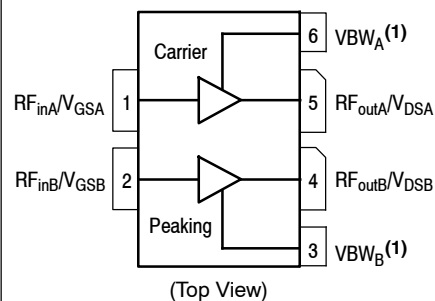

Figure 1. Pin Connections

- Device cannot operate with the V_{DD} current supplied through pin 3 and pin 6.

Table 1. Maximum Ratings

Rating	Symbol	Value	Unit
Drain-Source Voltage	V_{DSS}	-0.5, +65	Vdc
Gate-Source Voltage	V_{GS}	-6.0, +10	Vdc
Operating Voltage	V_{DD}	32, +0	Vdc
Storage Temperature Range	T_{stg}	-65 to +150	°C
Case Operating Temperature Range	T_C	-40 to +150	°C
Operating Junction Temperature Range (1,2)	T_J	-40 to +225	°C

Table 2. Thermal Characteristics

Characteristic	Symbol	Value (2,3)	Unit
Thermal Resistance, Junction to Case Case Temperature 75°C, 28 W Avg., W-CDMA, 28 Vdc, $I_{DQA} = 400$ mA, $V_{GSB} = 0.65$ Vdc, 1840 MHz	$R_{\theta JC}$	0.45	°C/W

Table 3. ESD Protection Characteristics

Test Methodology	Class
Human Body Model (per JESD22-A114)	2
Machine Model (per EIA/JESD22-A115)	B
Charge Device Model (per JESD22-C101)	IV

Table 4. Electrical Characteristics ($T_A = 25^\circ\text{C}$ unless otherwise noted)

Characteristic	Symbol	Min	Typ	Max	Unit
----------------	--------	-----	-----	-----	------

Off Characteristics (4)

Zero Gate Voltage Drain Leakage Current ($V_{DS} = 65$ Vdc, $V_{GS} = 0$ Vdc)	I_{DSS}	—	—	10	μAdc
Zero Gate Voltage Drain Leakage Current ($V_{DS} = 32$ Vdc, $V_{GS} = 0$ Vdc)	I_{DSS}	—	—	1	μAdc
Gate-Source Leakage Current ($V_{GS} = 5$ Vdc, $V_{DS} = 0$ Vdc)	I_{GSS}	—	—	1	μAdc

On Characteristics - Side A, Carrier

Gate Threshold Voltage ($V_{DS} = 10$ Vdc, $I_D = 60$ μAdc)	$V_{GS(th)}$	0.8	1.2	1.6	Vdc
Gate Quiescent Voltage ($V_{DD} = 28$ Vdc, $I_D = 400$ mAdc, Measured in Functional Test)	$V_{GSA(Q)}$	1.4	1.8	2.2	Vdc
Drain-Source On-Voltage ($V_{GS} = 10$ Vdc, $I_D = 0.6$ Adc)	$V_{DS(on)}$	0.1	0.15	0.3	Vdc

On Characteristics - Side B, Peaking

Gate Threshold Voltage ($V_{DS} = 10$ Vdc, $I_D = 100$ μAdc)	$V_{GS(th)}$	0.8	1.2	1.6	Vdc
Drain-Source On-Voltage ($V_{GS} = 10$ Vdc, $I_D = 1.0$ Adc)	$V_{DS(on)}$	0.1	0.15	0.3	Vdc

1. Continuous use at maximum temperature will affect MTTF.
2. MTTF calculator available at <http://www.freescale.com/rf/calculators>.
3. Refer to [AN1955](#), *Thermal Measurement Methodology of RF Power Amplifiers*. Go to <http://www.freescale.com/rf> and search for AN1955.
4. Each side of device measured separately.

(continued)

Table 4. Electrical Characteristics ($T_A = 25^\circ\text{C}$ unless otherwise noted) (continued)

Characteristic	Symbol	Min	Typ	Max	Unit
Functional Tests ^(1,2) (In Freescale Doherty Test Fixture, 50 ohm system) $V_{DD} = 28\text{ Vdc}$, $I_{DQA} = 400\text{ mA}$, $V_{GSB} = 0.65\text{ Vdc}$, $P_{out} = 28\text{ W Avg.}$, $f = 1805\text{ MHz}$, Single-Carrier W-CDMA, IQ Magnitude Clipping, Input Signal PAR = 9.9 dB @ 0.01% Probability on CCDF. ACPR measured in 3.84 MHz Channel Bandwidth @ $\pm 5\text{ MHz}$ Offset.					
Power Gain	G_{ps}	17.3	17.9	20.3	dB
Drain Efficiency	η_D	47.5	49.9	—	%
Output Peak-to-Average Ratio @ 0.01% Probability on CCDF	PAR	7.3	7.7	—	dB
Adjacent Channel Power Ratio	ACPR	—	-32.0	-29.5	dBc

Load Mismatch ⁽²⁾ (In Freescale Doherty Test Fixture, 50 ohm system) $I_{DQA} = 400\text{ mA}$, $V_{GSB} = 0.65\text{ Vdc}$, $f = 1840\text{ MHz}$

VSWR 10:1 at 32 Vdc, 158 W CW Output Power (3 dB Input Overdrive from 100 W CW Rated Power)	No Device Degradation
--	-----------------------

Typical Performance ⁽²⁾ (In Freescale Doherty Test Fixture, 50 ohm system) $V_{DD} = 28\text{ Vdc}$, $I_{DQA} = 400\text{ mA}$, $V_{GSB} = 0.65\text{ Vdc}$, 1805–1880 MHz Bandwidth

P_{out} @ 1 dB Compression Point, CW	P1dB	—	126	—	W
P_{out} @ 3 dB Compression Point ⁽³⁾	P3dB	—	182	—	W
AM/PM (Maximum value measured at the P3dB compression point across the 1805–1880 MHz frequency range)	Φ	—	-10.3	—	°
VBW Resonance Point (IMD Third Order Intermodulation Inflection Point)	VBW_{res}	—	135	—	MHz
Gain Flatness in 75 MHz Bandwidth @ $P_{out} = 28\text{ W Avg.}$	G_F	—	0.04	—	dB
Gain Variation over Temperature (-30°C to +85°C)	ΔG	—	0.008	—	dB/°C
Output Power Variation over Temperature (-30°C to +85°C)	$\Delta P1dB$	—	0.003	—	dB/°C

Table 5. Ordering Information

Device	Tape and Reel Information	Package
A2T18H160-24SR3	R3 Suffix = 250 Units, 44 mm Tape Width, 13-inch Reel	NI-780S-4L2L

- Part internally matched both on input and output.
- Measurements made with device in an asymmetrical Doherty configuration.
- $P3dB = P_{avg} + 7.0\text{ dB}$ where P_{avg} is the average output power measured using an unclipped W-CDMA single-carrier input signal where output PAR is compressed to 7.0 dB @ 0.01% probability on CCDF.

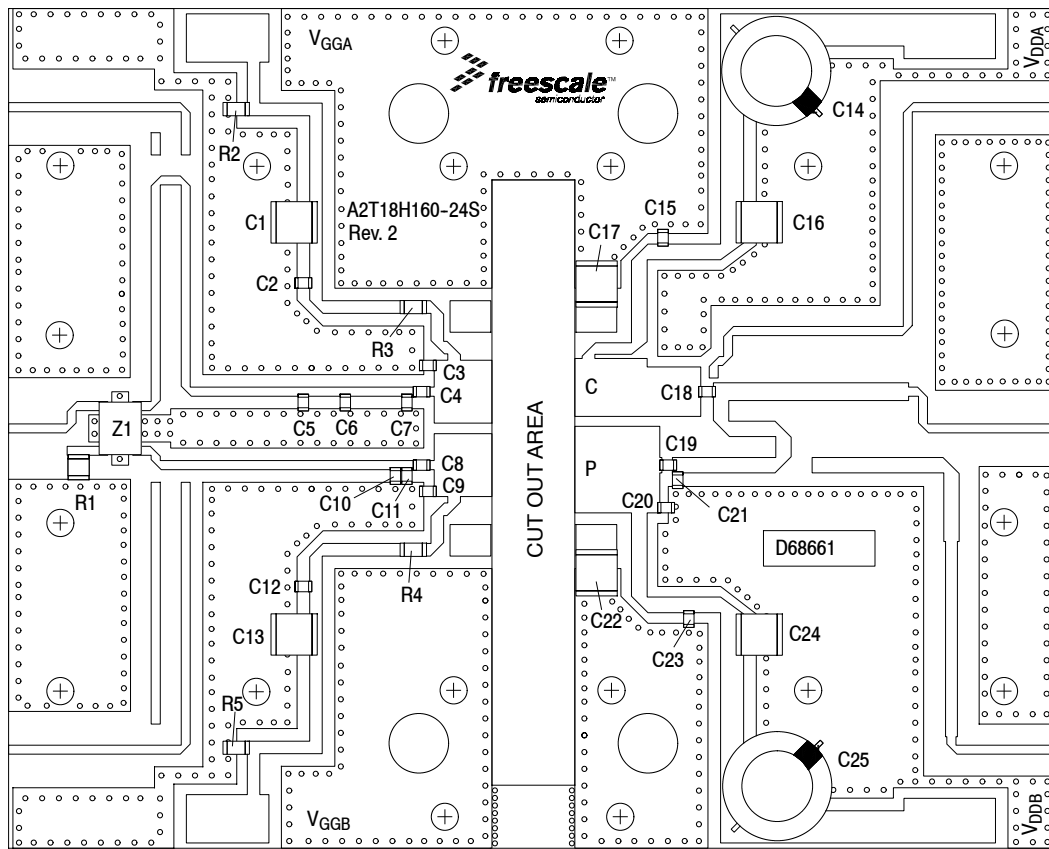

Figure 2. A2T18H160-24SR3 Test Circuit Component Layout

Table 6. A2T18H160-24SR3 Test Circuit Component Designations and Values

Part	Description	Part Number	Manufacturer
PCB		D58628	MTL
C1, C13, C16, C17, C22, C24	10 μ F Chip Capacitors	C5750X7S2A106M230KB	TDK
C2, C4, C8, C12, C15, C19, C23	12 pF Chip Capacitors	ATC600F120JT250XT	ATC
C3	1.8 pF Chip Capacitor	ATC600F1R8BT250XT	ATC
C5, C6	0.3 pF Chip Capacitors	ATC600F0R3BT250XT	ATC
C7	1.0 pF Chip Capacitor	ATC600F1R0BT250XT	ATC
C9	2.0 pF Chip Capacitor	ATC600F2R0BT250XT	ATC
C10, C11, C20	0.5 pF Chip Capacitors	ATC600F0R5BT250XT	ATC
C14, C25	220 μ F, 50 V Electrolytic Capacitors	227CKS050M	Illinois Capacitor
C18	9.1 pF Chip Capacitor	ATC600F9R1BT250XT	ATC
C21	1.5 pF Chip Capacitor	ATC600F1R5BT250XT	ATC
R1	50 Ω , 4 W Chip Resistor	C10A50Z4	Anaren
R2, R5	20 K Ω , 1/4 W Chip Resistors	CRCW120620K0JNEA	Vishay
R3, R4	5.6 Ω , 1/4 W Chip Resistors	CRCW12065R60FKEA	Vishay
Z1	1700–2000 MHz Band, 90°, 5 dB Directional Coupler	X3C19P1-05S	Anaren
PCB	Rogers RO4350B, 0.020", $\epsilon_r = 3.66$	D68661	MTL

TYPICAL CHARACTERISTICS

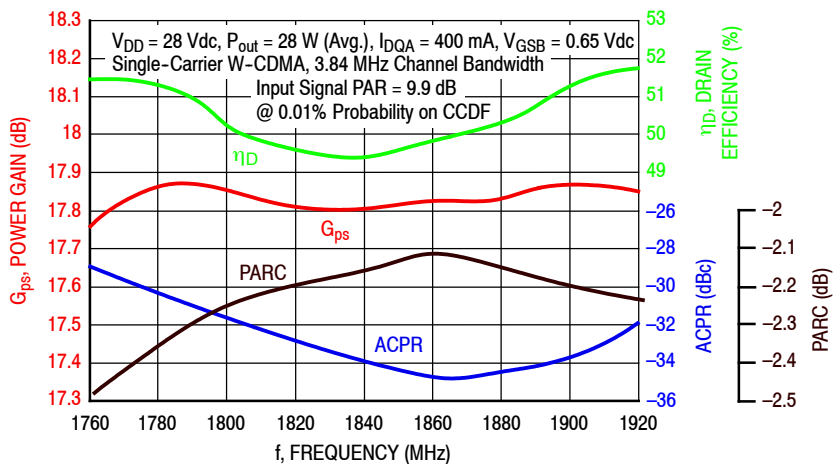

Figure 3. Single-Carrier Output Peak-to-Average Ratio Compression (PARC) Broadband Performance @ $P_{out} = 28$ Watts Avg.

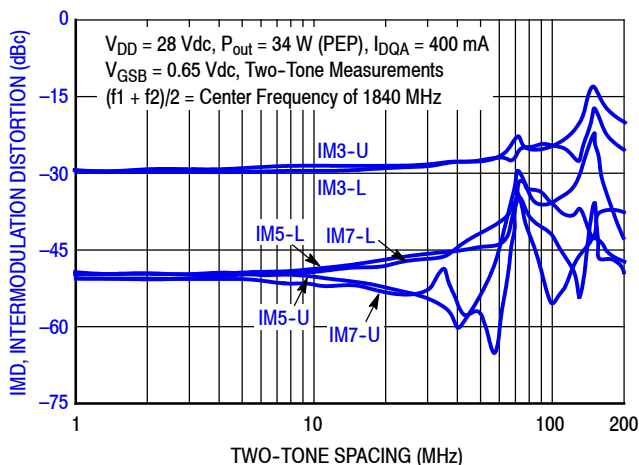

Figure 4. Intermodulation Distortion Products versus Two-Tone Spacing

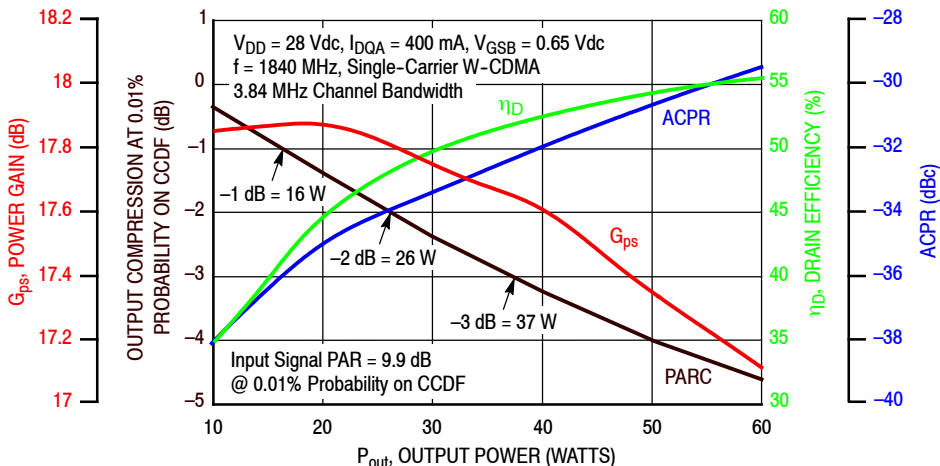

Figure 5. Output Peak-to-Average Ratio Compression (PARC) versus Output Power

TYPICAL CHARACTERISTICS

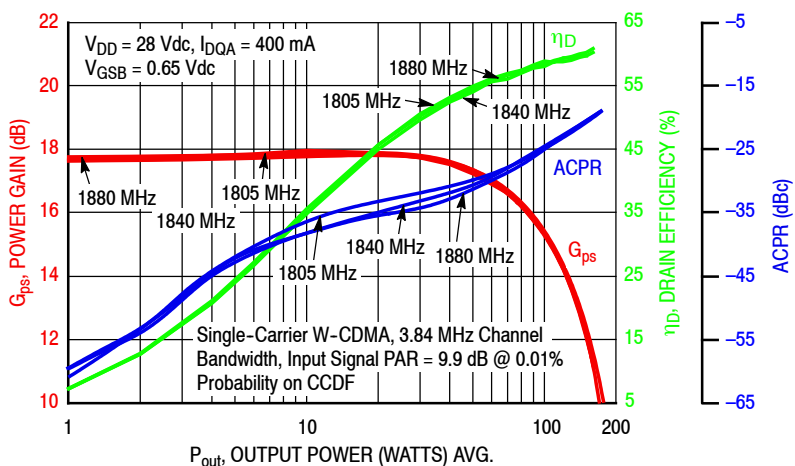

Figure 6. Single-Carrier W-CDMA Power Gain, Drain Efficiency and ACPR versus Output Power

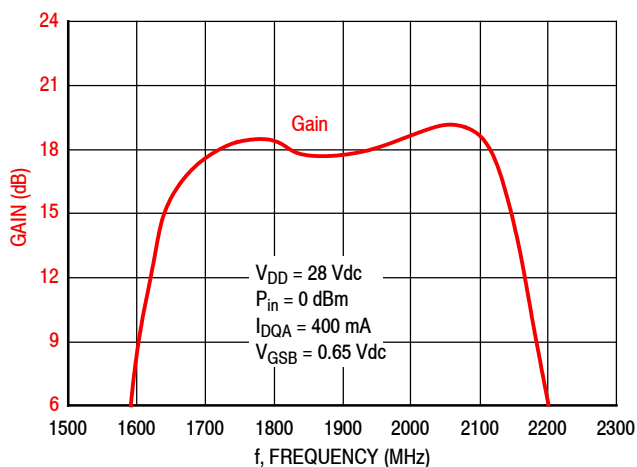

Figure 7. Broadband Frequency Response

Table 7. Carrier Side Load Pull Performance — Maximum Power Tuning
 $V_{DD} = 28 \text{ Vdc}$, $I_{DQA} = 408 \text{ mA}$, Pulsed CW, 10 μsec (on), 10% Duty Cycle

f (MHz)	Z_{source} (Ω)	Z_{in} (Ω)	Max Output Power					
			P1dB					
			$Z_{\text{load}}^{(1)}$ (Ω)	Gain (dB)	(dBm)	(W)	η_D (%)	AM/PM ($^\circ$)
1805	2.25 – j8.58	2.61 + j7.74	4.68 – j7.50	20.1	48.7	73	61.5	–15
1840	2.88 – j9.59	2.95 + j8.30	4.73 – j8.14	20.0	48.7	75	61.6	–15
1880	4.30 – j10.4	3.95 + j8.89	4.76 – j8.44	20.0	48.6	72	60.2	–15

f (MHz)	Z_{source} (Ω)	Z_{in} (Ω)	Max Output Power					
			P3dB					
			$Z_{\text{load}}^{(2)}$ (Ω)	Gain (dB)	(dBm)	(W)	η_D (%)	AM/PM ($^\circ$)
1805	2.25 – j8.58	2.53 + j8.36	4.68 – j8.41	18.0	49.4	87	62.3	–22
1840	2.88 – j9.59	2.91 + j9.02	4.71 – j8.78	17.9	49.4	87	62.6	–23
1880	4.30 – j10.4	4.06 + j9.90	4.89 – j9.14	18.0	49.3	85	61.3	–22

(1) Load impedance for optimum P1dB power.

(2) Load impedance for optimum P3dB power.

 Z_{source} = Measured impedance presented to the input of the device at the package reference plane.

 Z_{in} = Impedance as measured from gate contact to ground.

 Z_{load} = Measured impedance presented to the output of the device at the package reference plane.

Table 8. Carrier Side Load Pull Performance — Maximum Drain Efficiency Tuning
 $V_{DD} = 28 \text{ Vdc}$, $I_{DQA} = 408 \text{ mA}$, Pulsed CW, 10 μsec (on), 10% Duty Cycle

f (MHz)	Z_{source} (Ω)	Z_{in} (Ω)	Max Drain Efficiency					
			P1dB					
			$Z_{\text{load}}^{(1)}$ (Ω)	Gain (dB)	(dBm)	(W)	η_D (%)	AM/PM ($^\circ$)
1805	2.25 – j8.58	2.13 + j7.81	7.94 – j3.73	22.2	47.2	52	71.5	–27
1840	2.88 – j9.59	2.33 + j8.41	7.67 – j3.36	22.1	47.0	50	71.9	–29
1880	4.30 – j10.4	3.13 + j9.13	7.25 – j3.56	22.3	46.9	49	71.0	–29

f (MHz)	Z_{source} (Ω)	Z_{in} (Ω)	Max Drain Efficiency					
			P3dB					
			$Z_{\text{load}}^{(2)}$ (Ω)	Gain (dB)	(dBm)	(W)	η_D (%)	AM/PM ($^\circ$)
1805	2.25 – j8.58	2.17 + j8.29	7.63 – j6.11	19.8	48.4	70	72.0	–31
1840	2.88 – j9.59	2.41 + j8.94	7.53 – j5.64	19.7	48.3	67	72.3	–32
1880	4.30 – j10.4	3.27 + j9.86	6.95 – j5.06	19.8	48.0	63	71.1	–34

(1) Load impedance for optimum P1dB efficiency.

(2) Load impedance for optimum P3dB efficiency.

 Z_{source} = Measured impedance presented to the input of the device at the package reference plane.

 Z_{in} = Impedance as measured from gate contact to ground.

 Z_{load} = Measured impedance presented to the output of the device at the package reference plane.

Table 9. Peaking Side Load Pull Performance — Maximum Power Tuning
 $V_{DD} = 28 \text{ Vdc}$, $V_{GSB} = 0.65 \text{ Vdc}$, Pulsed CW, 10 μsec (on), 10% Duty Cycle

f (MHz)	Z_{source} (Ω)	Z_{in} (Ω)	Max Output Power					
			P1dB					
			$Z_{\text{load}}^{(1)}$ (Ω)	Gain (dB)	(dBm)	(W)	η_D (%)	AM/PM ($^\circ$)
1805	2.70 – j9.87	2.49 + j9.58	3.97 – j9.45	15.5	50.5	112	56.5	–30
1840	3.29 – j10.6	2.89 + j10.3	3.81 – j9.81	15.4	50.5	113	55.7	–31
1880	5.01 – j11.4	4.06 + j11.3	4.09 – j10.1	15.5	50.5	111	56.0	–31

f (MHz)	Z_{source} (Ω)	Z_{in} (Ω)	Max Output Power					
			P3dB					
			$Z_{\text{load}}^{(2)}$ (Ω)	Gain (dB)	(dBm)	(W)	η_D (%)	AM/PM ($^\circ$)
1805	2.70 – j9.87	2.51 + j10.1	3.84 – j9.87	13.3	51.2	132	56.6	–38
1840	3.29 – j10.6	2.95 + j10.8	3.92 – j10.2	13.3	51.2	133	57.0	–39
1880	5.01 – j11.4	4.34 + j12.1	4.17 – j10.5	13.4	51.1	129	56.7	–39

(1) Load impedance for optimum P1dB power.

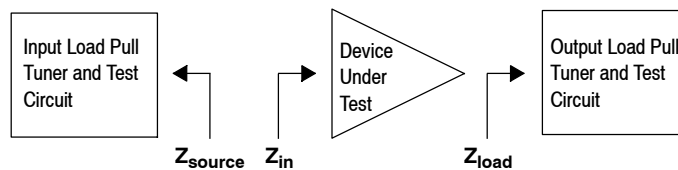
(2) Load impedance for optimum P3dB power.

 Z_{source} = Measured impedance presented to the input of the device at the package reference plane.

 Z_{in} = Impedance as measured from gate contact to ground.

 Z_{load} = Measured impedance presented to the output of the device at the package reference plane.

Table 10. Peaking Side Load Pull Performance — Maximum Drain Efficiency Tuning
 $V_{DD} = 28 \text{ Vdc}$, $V_{GSB} = 0.65 \text{ Vdc}$, Pulsed CW, 10 μsec (on), 10% Duty Cycle

f (MHz)	Z_{source} (Ω)	Z_{in} (Ω)	Max Drain Efficiency					
			P1dB					
			$Z_{\text{load}}^{(1)}$ (Ω)	Gain (dB)	(dBm)	(W)	η_D (%)	AM/PM ($^\circ$)
1805	2.70 – j9.87	2.08 + j9.49	8.64 – j6.58	16.8	48.9	78	69.4	–35
1840	3.29 – j10.6	2.35 + j10.1	8.17 – j6.08	16.8	48.9	77	69.8	–36
1880	5.01 – j11.4	3.22 + j11.2	7.22 – j5.33	16.8	48.7	73	69.7	–36

f (MHz)	Z_{source} (Ω)	Z_{in} (Ω)	Max Drain Efficiency					
			P3dB					
			$Z_{\text{load}}^{(2)}$ (Ω)	Gain (dB)	(dBm)	(W)	η_D (%)	AM/PM ($^\circ$)
1805	2.70 – j9.87	2.17 + j10.0	8.72 – j7.75	14.6	49.7	92	67.9	–43
1840	3.29 – j10.6	2.54 + j10.8	8.30 – j7.39	14.7	49.7	94	68.6	–44
1880	5.01 – j11.4	3.64 + j12.1	7.94 – j6.26	14.8	49.4	87	68.3	–45

(1) Load impedance for optimum P1dB efficiency.

(2) Load impedance for optimum P3dB efficiency.

 Z_{source} = Measured impedance presented to the input of the device at the package reference plane.

 Z_{in} = Impedance as measured from gate contact to ground.

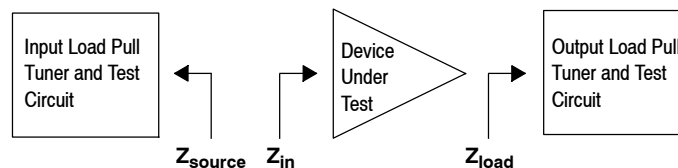
 Z_{load} = Measured impedance presented to the output of the device at the package reference plane.

P1dB – TYPICAL CARRIER LOAD PULL CONTOURS — 1840 MHz

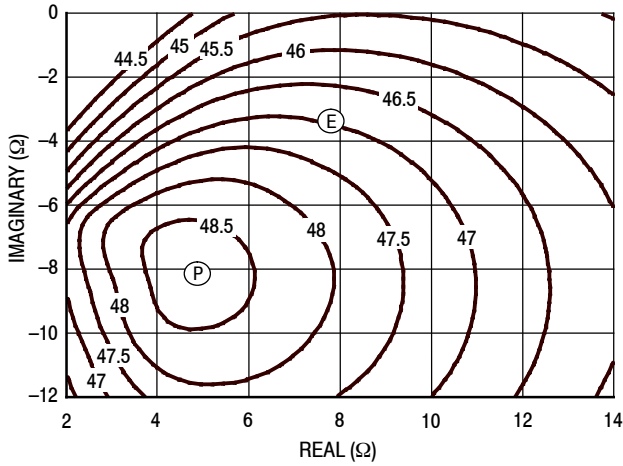

Figure 8. P1dB Load Pull Output Power Contours (dBm)

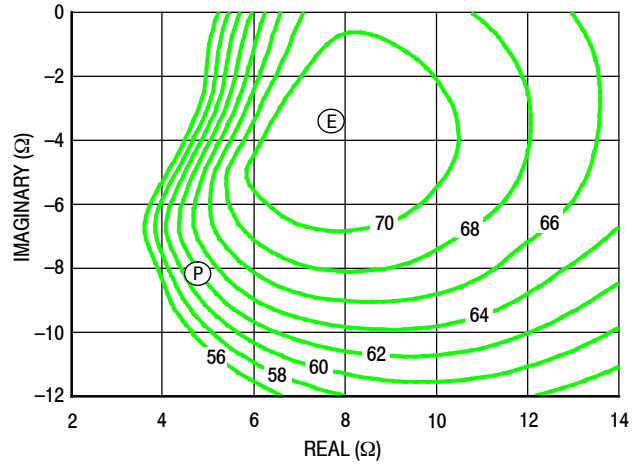

Figure 9. P1dB Load Pull Efficiency Contours (%)

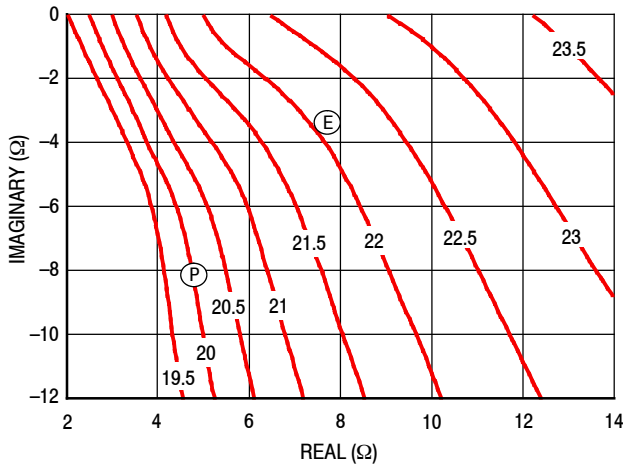

Figure 10. P1dB Load Pull Gain Contours (dB)

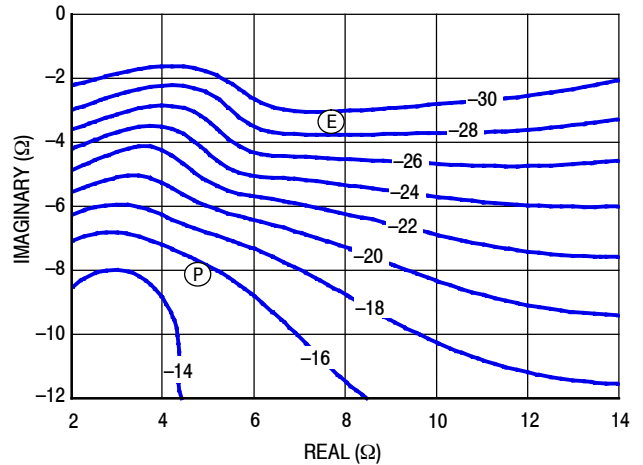

Figure 11. P1dB Load Pull AM/PM Contours (°)

NOTE: (P) = Maximum Output Power
(E) = Maximum Drain Efficiency

- Gain
- Drain Efficiency
- Linearity
- Output Power

P3dB – TYPICAL CARRIER LOAD PULL CONTOURS — 1840 MHz

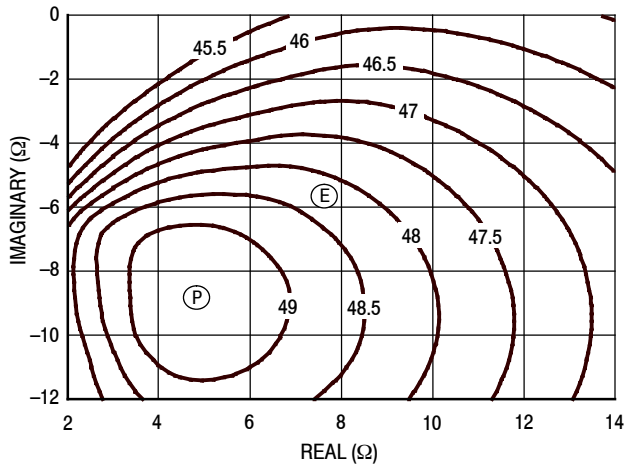

Figure 12. P3dB Load Pull Output Power Contours (dBm)

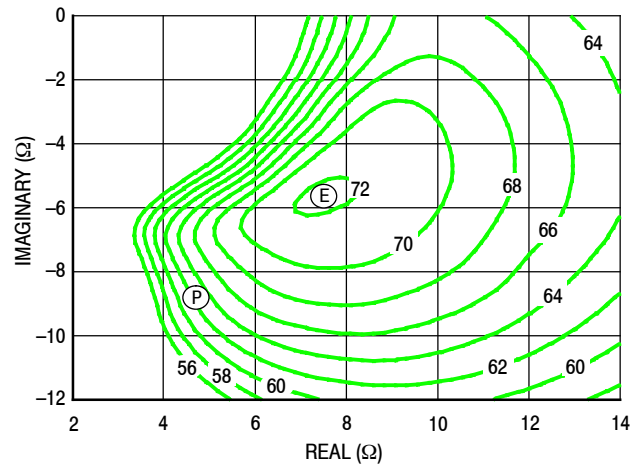

Figure 13. P3dB Load Pull Efficiency Contours (%)

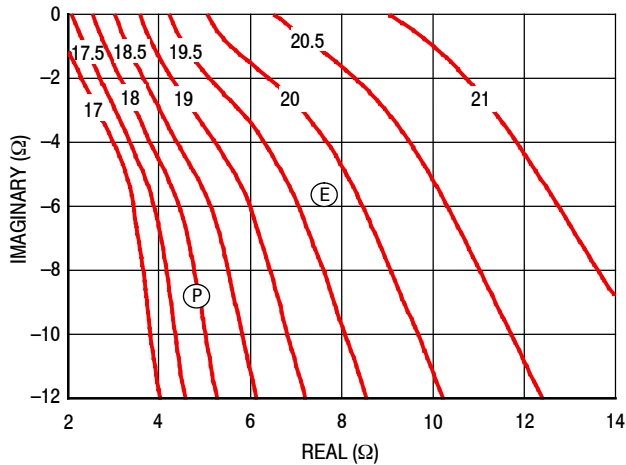

Figure 14. P3dB Load Pull Gain Contours (dB)

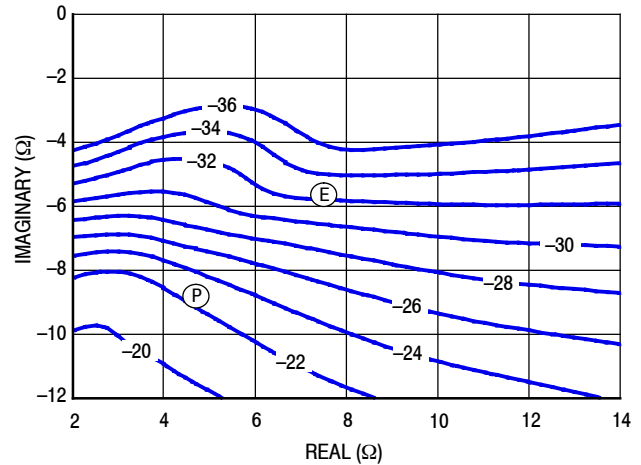

Figure 15. P3dB Load Pull AM/PM Contours (°)

NOTE: (P) = Maximum Output Power
(E) = Maximum Drain Efficiency

- Gain
- Drain Efficiency
- Linearity
- Output Power

P1dB – TYPICAL PEAKING LOAD PULL CONTOURS — 1840 MHz

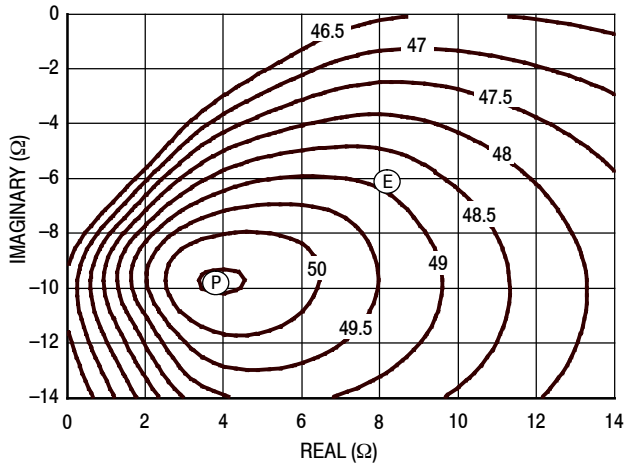

Figure 16. P1dB Load Pull Output Power Contours (dBm)

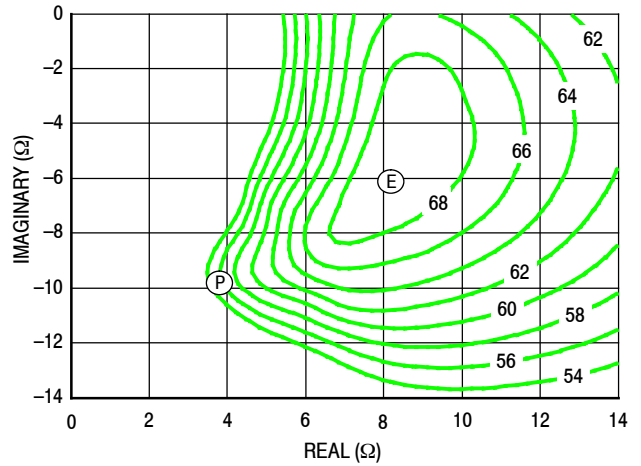

Figure 17. P1dB Load Pull Efficiency Contours (%)

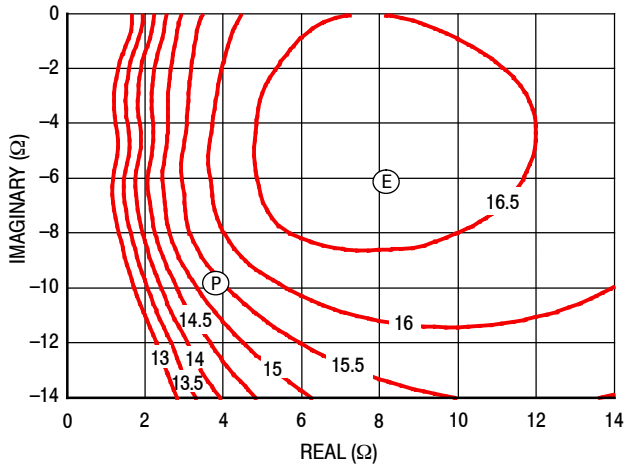

Figure 18. P1dB Load Pull Gain Contours (dB)

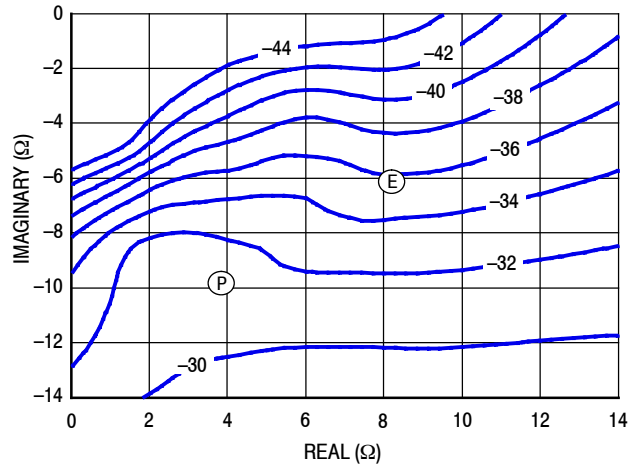

Figure 19. P1dB Load Pull AM/PM Contours (°)

NOTE: (P) = Maximum Output Power
 (E) = Maximum Drain Efficiency

- Gain
- Drain Efficiency
- Linearity
- Output Power

P3dB – TYPICAL PEAKING LOAD PULL CONTOURS — 1840 MHz

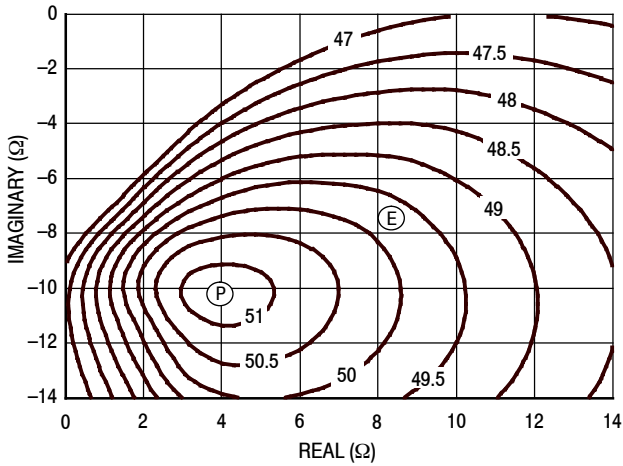

Figure 20. P3dB Load Pull Output Power Contours (dBm)

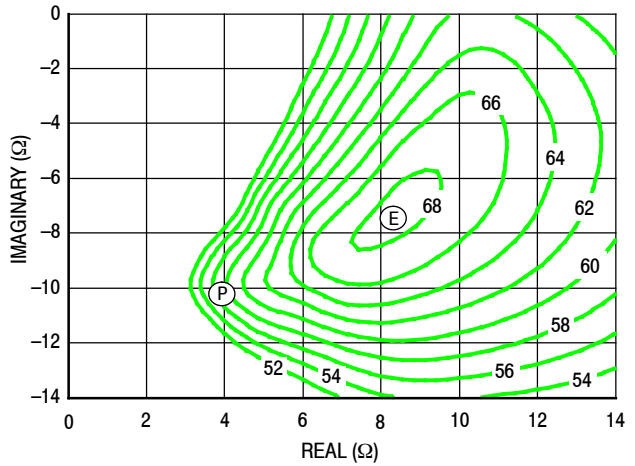

Figure 21. P3dB Load Pull Efficiency Contours (%)

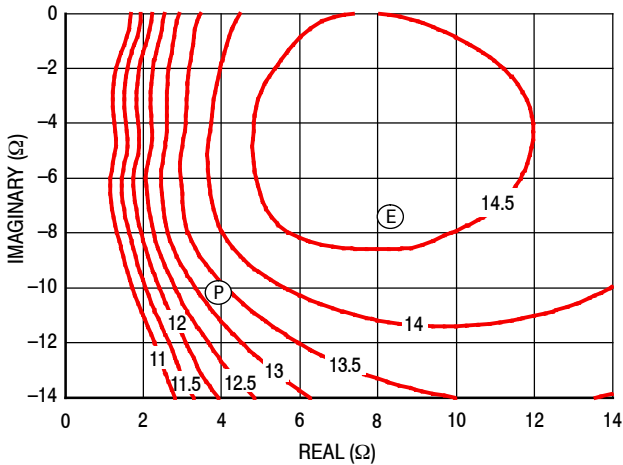

Figure 22. P3dB Load Pull Gain Contours (dB)

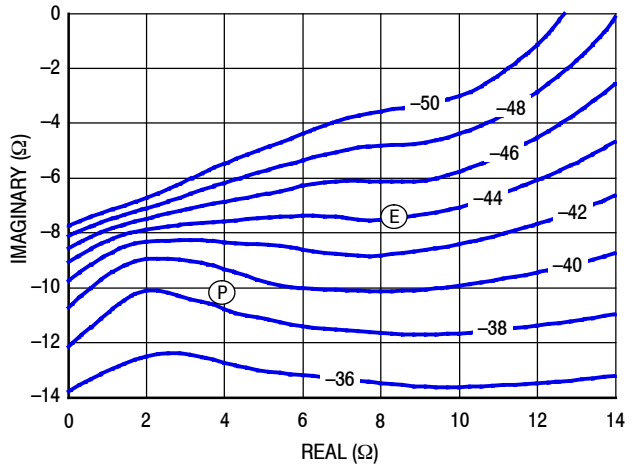
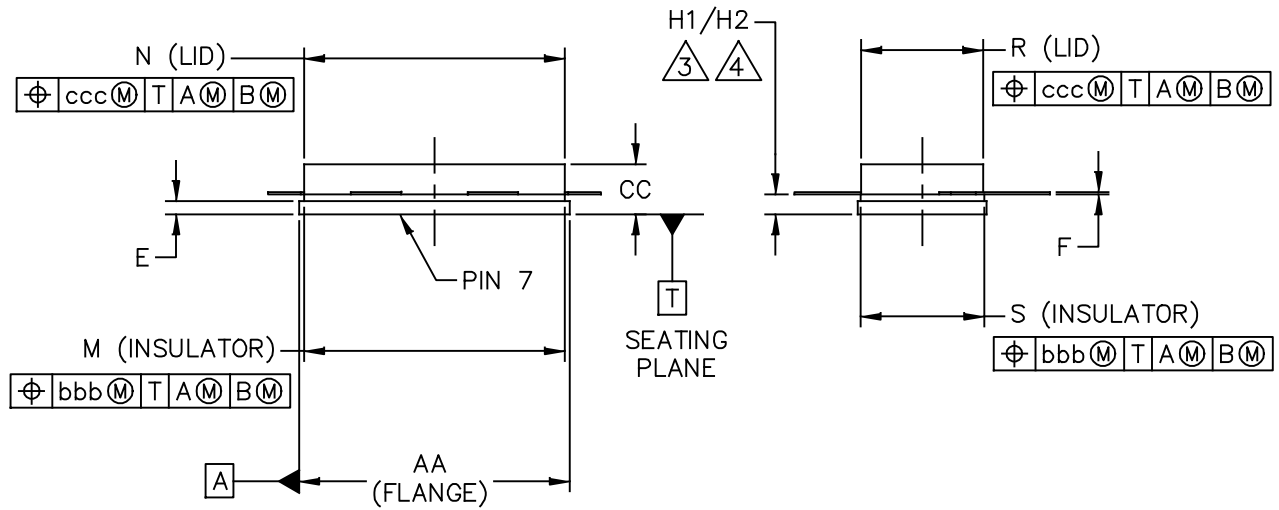
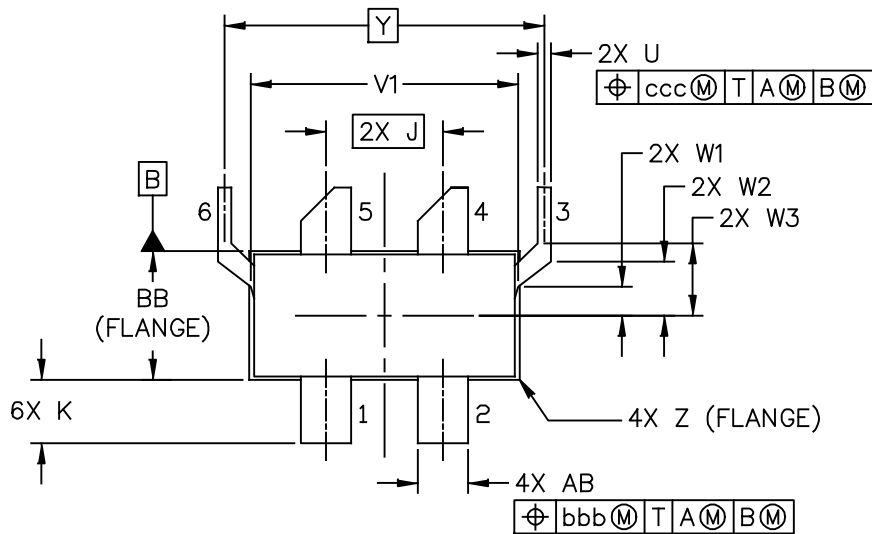

Figure 23. P3dB Load Pull AM/PM Contours (°)

NOTE: (P) = Maximum Output Power
 (E) = Maximum Drain Efficiency

- Gain
- Drain Efficiency
- Linearity
- Output Power

PACKAGE DIMENSIONS



© FREESCALE SEMICONDUCTOR, INC. ALL RIGHTS RESERVED.	MECHANICAL OUTLINE	PRINT VERSION NOT TO SCALE
TITLE: NI-780S-4L2L	DOCUMENT NO: 98ASA00674D REV: 0	STANDARD: NON-JEDEC
	16 JAN 2014	

NOTES:

1. CONTROLLING DIMENSION: INCH.
2. INTERPRET DIMENSIONS AND TOLERANCES PER ASME Y14.5M-1994.

3. DIMENSIONS H1 AND H2 ARE MEASURED .030 INCH (0.762 MM) AWAY FROM FLANGE PARALLEL TO DATUM B. H1 APPLIES TO PINS 1, 2, 4 & 5. H2 APPLIES TO PINS 3 & 6.

4. TOLERANCE OF DIMENSION H2 IS TENTATIVE.

DIM	INCH		MILLIMETER		DIM	INCH		MILLIMETER	
	MIN	MAX	MIN	MAX		MIN	MAX	MIN	MAX
AA	.805	.815	20.45	20.70	R	.365	.375	9.27	9.53
BB	.380	.390	9.65	9.91	S	.365	.375	9.27	9.53
CC	.125	.170	3.18	4.32	U	.035	.045	0.89	1.14
E	.035	.045	0.89	1.14	V1	.795	.805	20.19	20.45
F	.004	.007	0.10	0.18	W1	.080	.090	2.03	2.29
H1	.057	.067	1.45	1.70	W2	.155	.165	3.94	4.19
H2	.054	.070	1.37	1.78	W3	.210	.220	5.33	5.59
J	.350 BSC		8.89 BSC		Y	.956 BSC		24.28 BSC	
K	.170	.210	4.32	5.33	Z	R.000	R.040	R0.00	R1.02
M	.774	.786	19.66	19.96	AB	.145	.155	3.68	3.94
N	.772	.788	19.61	20.02	aaa	.005		0.13	
					bbb	.010		0.25	
					ccc	.015		0.38	
© FREESCALE SEMICONDUCTOR, INC. ALL RIGHTS RESERVED.			MECHANICAL OUTLINE			PRINT VERSION NOT TO SCALE			
TITLE: NI-780S-4L2L					DOCUMENT NO: 98ASA00674D			REV: 0	
					STANDARD: NON-JEDEC				
					16 JAN 2014				

Refer to the following resources to aid your design process.

Application Notes

- AN1955: Thermal Measurement Methodology of RF Power Amplifiers

Engineering Bulletins

- EB212: Using Data Sheet Impedances for RF LDMOS Devices

Software

- Electromigration MTTF Calculator
- RF High Power Model
- s2p File

Development Tools

- Printed Circuit Boards

To Download Resources Specific to a Given Part Number:

1. Go to <http://www.freescale.com/rf>
2. Search by part number
3. Click part number link
4. Choose the desired resource from the drop down menu

REVISION HISTORY

The following table summarizes revisions to this document.

Revision	Date	Description
0	Nov. 2015	• Initial Release of Data Sheet

How to Reach Us:

Home Page:
freescale.com

Web Support:
freescale.com/support

Information in this document is provided solely to enable system and software implementers to use Freescale products. There are no express or implied copyright licenses granted hereunder to design or fabricate any integrated circuits based on the information in this document.

Freescale reserves the right to make changes without further notice to any products herein. Freescale makes no warranty, representation, or guarantee regarding the suitability of its products for any particular purpose, nor does Freescale assume any liability arising out of the application or use of any product or circuit, and specifically disclaims any and all liability, including without limitation consequential or incidental damages. "Typical" parameters that may be provided in Freescale data sheets and/or specifications can and do vary in different applications, and actual performance may vary over time. All operating parameters, including "typicals," must be validated for each customer application by customer's technical experts. Freescale does not convey any license under its patent rights nor the rights of others. Freescale sells products pursuant to standard terms and conditions of sale, which can be found at the following address: freescale.com/SalesTermsandConditions.

Freescale and the Freescale logo are trademarks of Freescale Semiconductor, Inc., Reg. U.S. Pat. & Tm. Off. Airfast is a trademark of Freescale Semiconductor, Inc. All other product or service names are the property of their respective owners.

© 2015 Freescale Semiconductor, Inc.

Данный компонент на территории Российской Федерации

Вы можете приобрести в компании MosChip.

Для оперативного оформления запроса Вам необходимо перейти по данной ссылке:

<http://moschip.ru/get-element>

Вы можете разместить у нас заказ для любого Вашего проекта, будь то серийное производство или разработка единичного прибора.

В нашем ассортименте представлены ведущие мировые производители активных и пассивных электронных компонентов.

Нашей специализацией является поставка электронной компонентной базы двойного назначения, продукции таких производителей как XILINX, Intel (ex.ALTERA), Vicor, Microchip, Texas Instruments, Analog Devices, Mini-Circuits, Amphenol, Glenair.

Сотрудничество с глобальными дистрибьюторами электронных компонентов, предоставляет возможность заказывать и получать с международных складов практически любой перечень компонентов в оптимальные для Вас сроки.

На всех этапах разработки и производства наши партнеры могут получить квалифицированную поддержку опытных инженеров.

Система менеджмента качества компании отвечает требованиям в соответствии с ГОСТ Р ИСО 9001, ГОСТ РВ 0015-002 и ЭС РД 009

Офис по работе с юридическими лицами:

105318, г.Москва, ул.Щербаковская д.3, офис 1107, 1118, ДЦ «Щербаковский»

Телефон: +7 495 668-12-70 (многоканальный)

Факс: +7 495 668-12-70 (доб.304)

E-mail: info@moschip.ru

Skype отдела продаж:

moschip.ru

moschip.ru_4

moschip.ru_6

moschip.ru_9