

Typical Applications

Prescaler for DC to Ku Band PLL Applications:

- Point-to-Point / Multi-Point Radios
- VSAT Radios
- Fiber Optic
- Test Equipment
- Space & Military

Features

- Ultra Low SSB Phase Noise: -151 dBc/Hz
- Wide Bandwidth
- Output Power: 7 dBm
- Single DC Supply: +5V
- 8 Lead Hermetic SMT Package

Functional Diagram

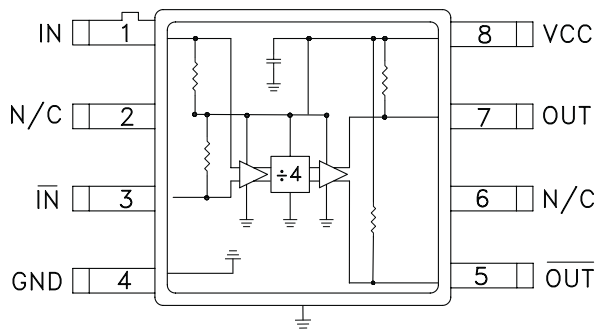

General Description

The HMC365G8 is a low noise Divide-by-4 Static Divider with InGaP GaAs HBT technology in an 8 lead glass/metal (hermetic) surface mount hermetic package. This device operates from DC (with a square wave input) to 13.0 GHz input frequency with a single +5.0V DC supply. The low additive SSB phase noise of -151 dBc/Hz at 100 kHz offset helps the user maintain good system noise performance.

Electrical Specifications, $T_A = +25^\circ C$, 50 Ohm System, $V_{CC} = 5V$

Parameter	Conditions	Min.	Typ.	Max.	Units
Maximum Input Frequency		13	14		GHz
Minimum Input Frequency	Sine Wave Input. [1]		0.2	0.5	GHz
Input Power Range	$F_{in} = 1$ to 11 GHz	-15	>-20	+10	dBm
	$F_{in} = 11$ to 12 GHz	-10	>-15	+5	dBm
	$F_{in} = 12$ to 13 GHz	-5	>-8	0	dBm
Output Power	$F_{in} = 13$ GHz	3	7		dBm
Reverse Leakage	Both RF Outputs Terminated		45		dB
SSB Phase Noise (100 kHz offset)	$P_{in} = 0$ dBm, $F_{in} = 6$ GHz		-151		dBc/Hz
Output Transition Time	$P_{in} = 0$ dBm, $F_{out} = 882$ MHz		100		ps
Supply Current (I_{CC})			120		mA

1. Divider will operate down to DC for square-wave input signal.

**SMT GaAs HBT MMIC
DIVIDE-BY-4, DC - 13.0 GHz**

Input Sensitivity Window, T= 25 °C

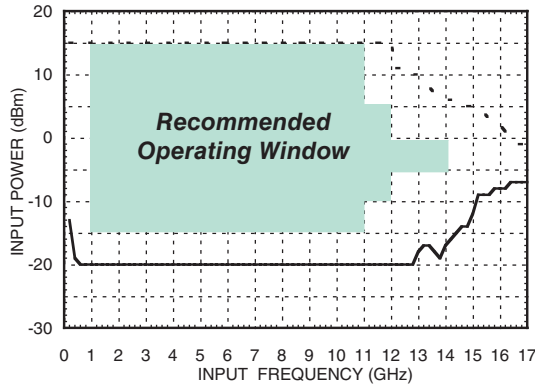

Input Sensitivity Window vs. Temperature

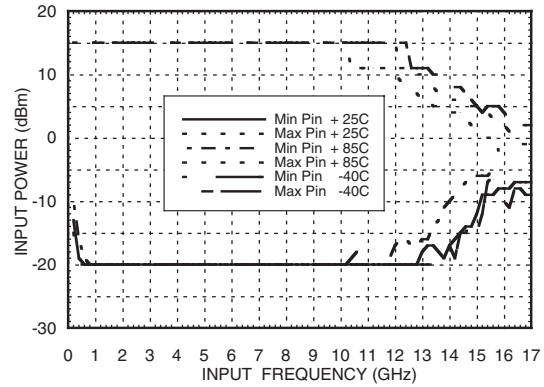

Output Power vs. Temperature

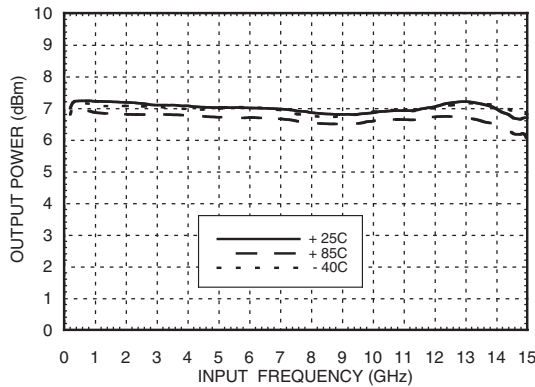

SSB Phase Noise

Performance, Pin= 0 dBm, T= 25 °C

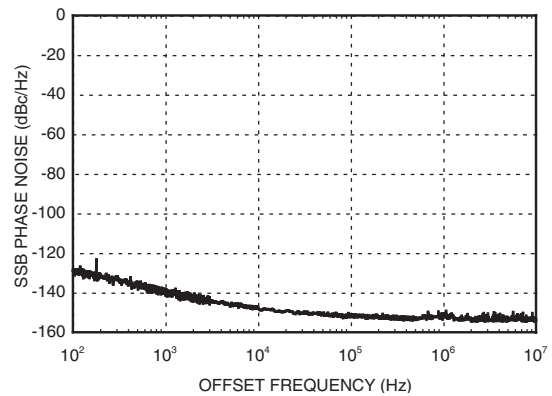

Output Harmonic

Content, Pin= 0 dBm, T= 25 °C

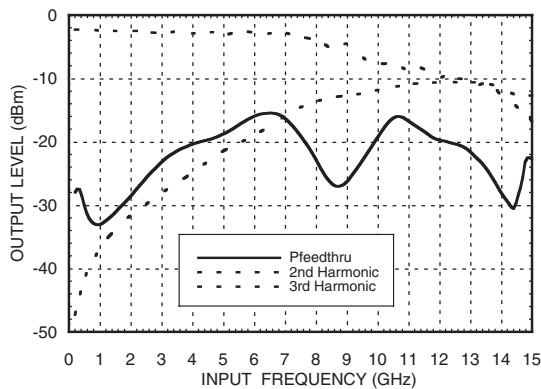

Reverse Leakage, Pin= 0 dBm, T= 25 °C

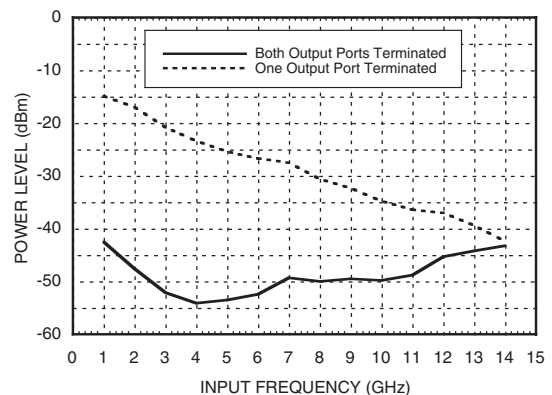

SMT GaAs HBT MMIC DIVIDE-BY-4, DC - 13.0 GHz

Output Voltage Waveform,
Pin = 0 dBm, Fout = 882 MHz, T = 25 °C

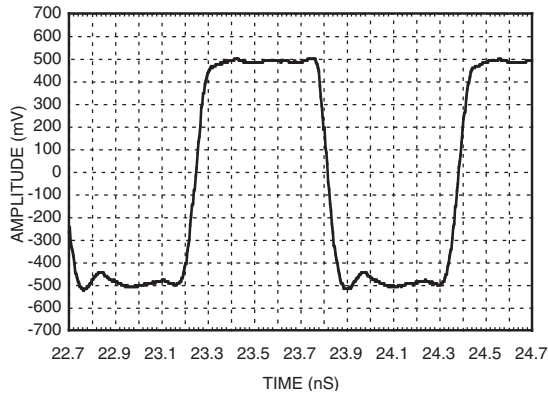

Absolute Maximum Ratings

RF Input (Vcc = +5V)	+13 dBm
Vcc	+5.5V
Junction Temperature (Tj)	135 °C
Continuous P _{diss} (T = 85 °C) (derate 12.5 mW/°C above 85 °C)	625 mW
Thermal Resistance (R _{TH}) (junction to ground paddle)	80 °C/W
Storage Temperature	-65 to -150 °C
Operating Temperature	-40 to +85 °C



**ELECTROSTATIC SENSITIVE DEVICE
OBSERVE HANDLING PRECAUTIONS**

Typical Supply Current vs. Vcc

Vcc (V)	Icc (mA)
4.75	110
5.0	120
5.25	130

Note: Divider will operate over full voltage range shown above

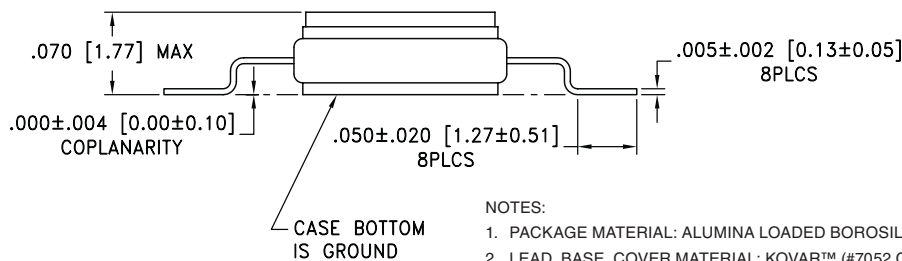
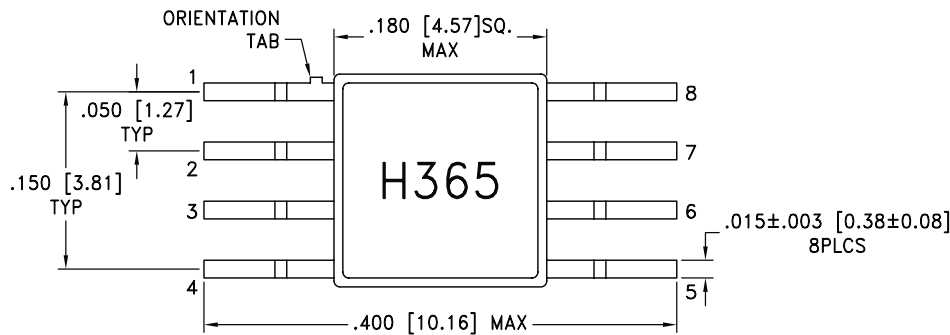

Outline Drawing



NOTES:

1. PACKAGE MATERIAL: ALUMINA LOADED BOROSILICATE GLASS.
2. LEAD, BASE, COVER MATERIAL: KOVAR™ (#7052 CORNING).
3. PLATING: ELECTROLYTIC GOLD 50 MICROINCHES MIN., OVER ELECTROLYTIC NICKEL 50 MICROINCHES MIN.
4. DIMENSIONS ARE IN INCHES [MILLIMETERS].
5. TOLERANCES: ±.005 [0.13] UNLESS OTHERWISE SPECIFIED.
6. ALL GROUND LEADS AND GROUND PADDLE MUST BE SOLDERED TO PCB RF GROUND.

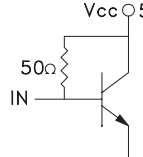
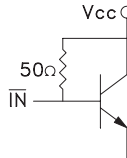
Pin Description

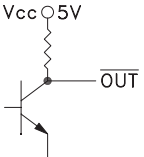
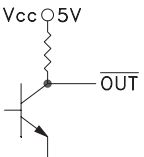
Pin Number	Function	Description	Interface Schematic
1	IN	RF Input must be DC blocked.	
2, 6	N/C	No connection.	
3	$\overline{\text{IN}}$	RF Input 180° out of phase with pin 1 for differential operation. AC ground for single ended operation.	
4	GND	Ground: Backside of package has exposed metal ground which must be connected to a RF/DC ground.	
5	$\overline{\text{OUT}}$	Divided output 180° out of phase with pin 7.	
7	OUT	Divided Output.	
8	VCC	Supply voltage 5V ± 0.25V.	

Evaluation PCB

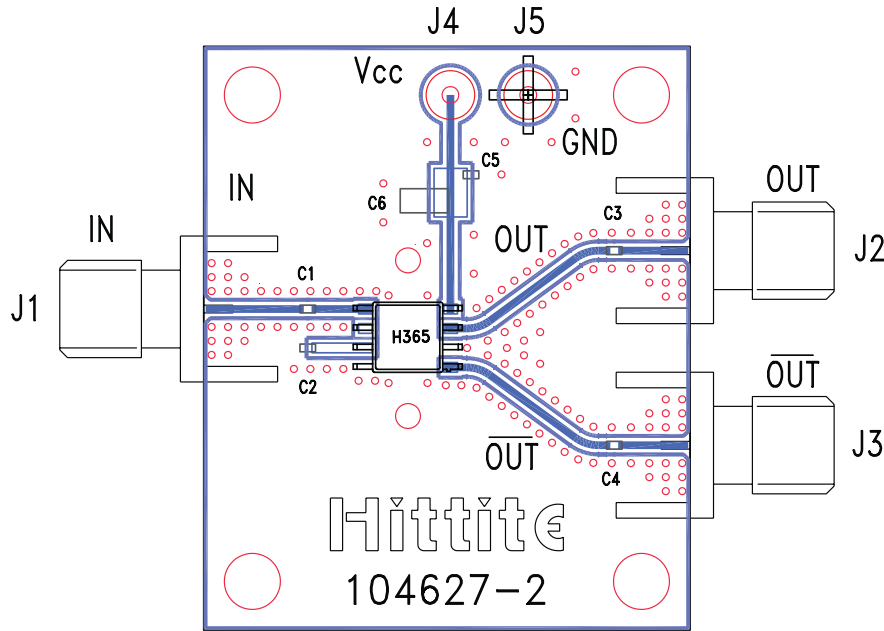

List of Materials for Evaluation PCB 106582 [1]

Item	Description
J1 - J3	PCB Mount SMA RF Connector
C1 - C4	100 pF Capacitor, 0402 Pkg,
C5	1000 pF Capacitor, 0603 Pkg.
C6	10 μ F Tantalum Capacitor
U1	HMC365G8 Divide-by-4
PCB [2]	104627 Eval Board

[1] Reference this number when ordering complete evaluation PCB

[2] Circuit Board Material: Rogers 4350

The circuit board used in the final application should use RF circuit design techniques. Signal lines should have 50 ohm impedance while the package ground leads and backside ground slug should be connected directly to the ground plane similar to that shown. A sufficient number of via holes should be used to connect the top and bottom ground planes. The evaluation circuit board shown is available from Hittite upon request. This evaluation board is designed for single ended input testing. J2 and J3 provide differential output signals.

Application Circuit

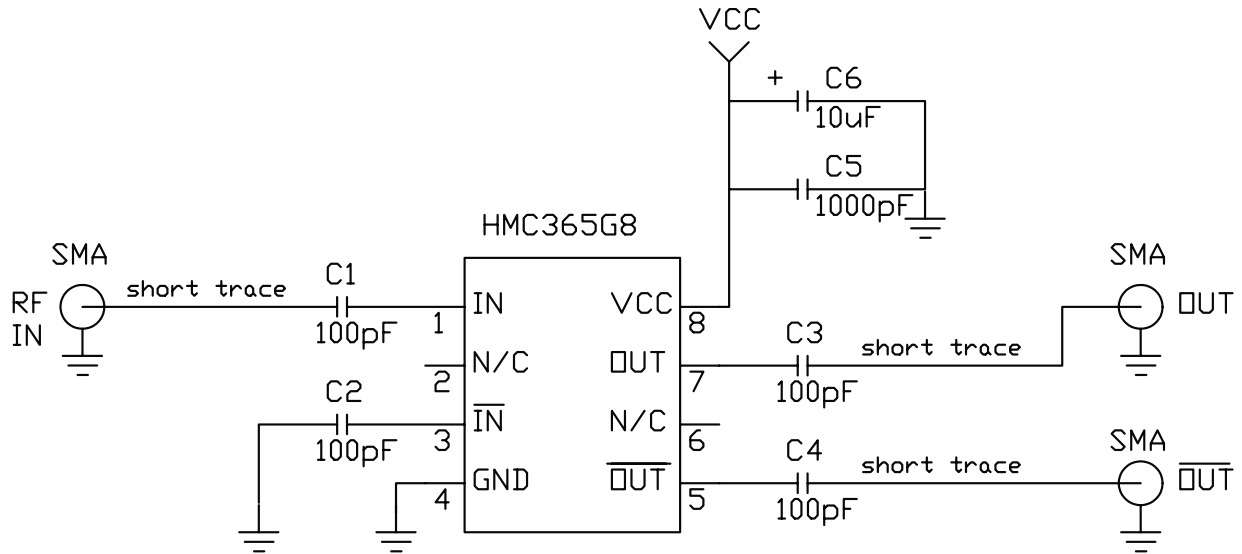

Данный компонент на территории Российской Федерации

Вы можете приобрести в компании MosChip.

Для оперативного оформления запроса Вам необходимо перейти по данной ссылке:

<http://moschip.ru/get-element>

Вы можете разместить у нас заказ для любого Вашего проекта, будь то серийное производство или разработка единичного прибора.

В нашем ассортименте представлены ведущие мировые производители активных и пассивных электронных компонентов.

Нашей специализацией является поставка электронной компонентной базы двойного назначения, продукции таких производителей как XILINX, Intel (ex.ALTERA), Vicor, Microchip, Texas Instruments, Analog Devices, Mini-Circuits, Amphenol, Glenair.

Сотрудничество с глобальными дистрибьюторами электронных компонентов, предоставляет возможность заказывать и получать с международных складов практически любой перечень компонентов в оптимальные для Вас сроки.

На всех этапах разработки и производства наши партнеры могут получить квалифицированную поддержку опытных инженеров.

Система менеджмента качества компании отвечает требованиям в соответствии с ГОСТ Р ИСО 9001, ГОСТ РВ 0015-002 и ЭС РД 009

Офис по работе с юридическими лицами:

105318, г.Москва, ул.Щербаковская д.3, офис 1107, 1118, ДЦ «Щербаковский»

Телефон: +7 495 668-12-70 (многоканальный)

Факс: +7 495 668-12-70 (доб.304)

E-mail: info@moschip.ru

Skype отдела продаж:

moschip.ru

moschip.ru_4

moschip.ru_6

moschip.ru_9