

MELODY-4-M2

~30° medium beam optimized for Nichia NCSW219A with 4 optics

TECHNICAL SPECIFICATIONS:

Dimensions	Ø 50.6 mm
Height	11.9 mm
Fastening	pin
ROHS compliant	yes ⓘ

MATERIAL SPECIFICATIONS:

Component	Type	Material	Colour	Finish
MELODY-4-M2	Multi-lens	PMMA	clear	



ORDERING INFORMATION:

Component	Qty in box	MOQ	MPQ	Box weight (kg)
C14054_MELODY-4-M2 » Box size: 480 x 280 x 300 mm	364	112	28	5.7

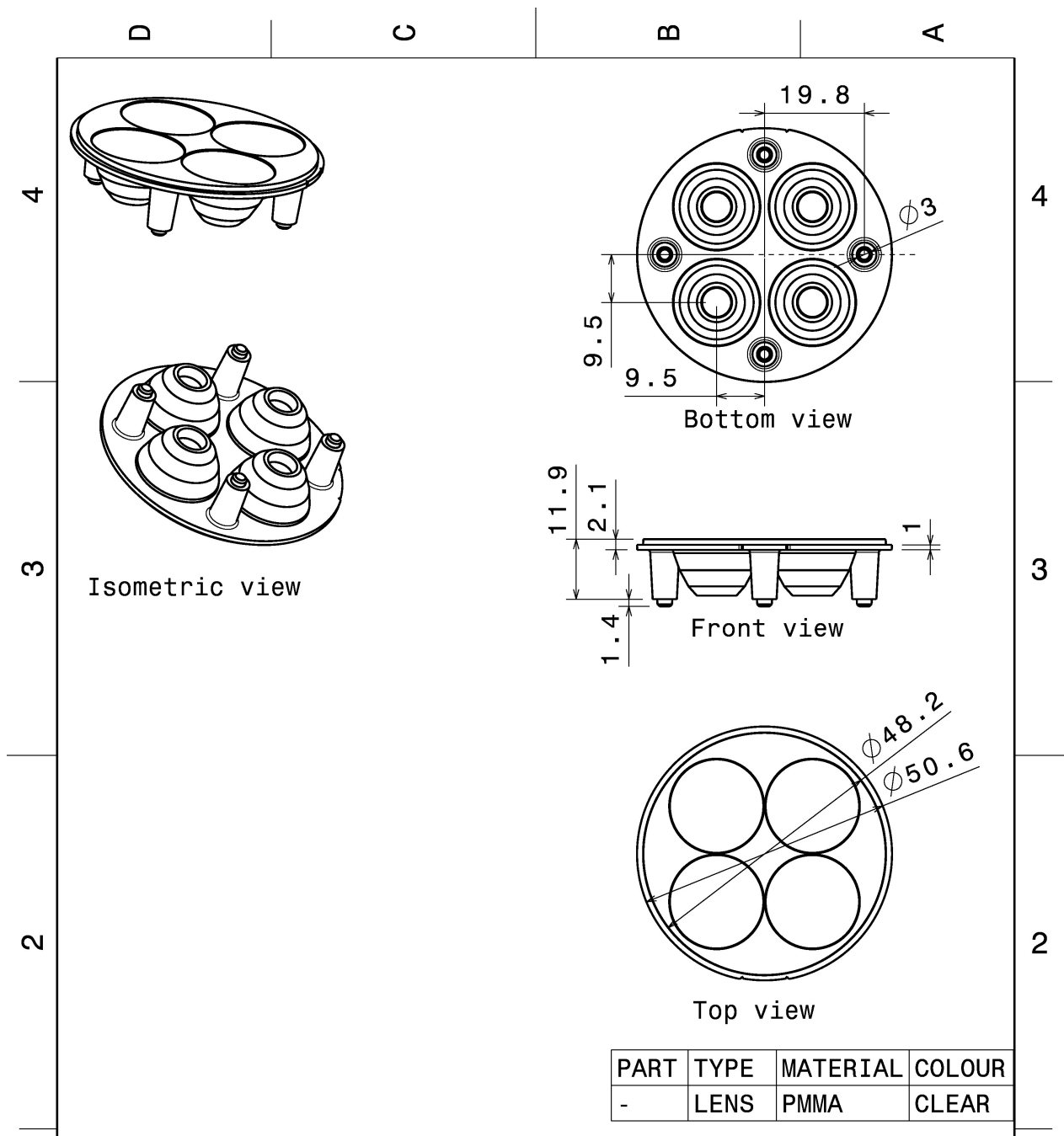

PART	TYPE	MATERIAL	COLOUR
-	LENS	PMMA	CLEAR

This drawing is our property. It can't be reproduced or communicated without our written agreement.

LEDiL
A WORLD OF INNOVATION

Ledil Oy
Joensuunkatu 13
FIN 24100 SALO
Finland

DRAWN BY mav		DATE 18.04.2012	DRAWING TITLE Datasheet MELODY-4 series			
CHECKED BY sn	DATE 18.04.2012	SIZE A4	DRAWING NUMBER -		REV 1	
DESIGNED BY mav	DATE 06.03.2012	SCALE 1:1	WEIGHT (g)	SHEET 1/1		





PHOTOMETRIC DATA (MEASURED):

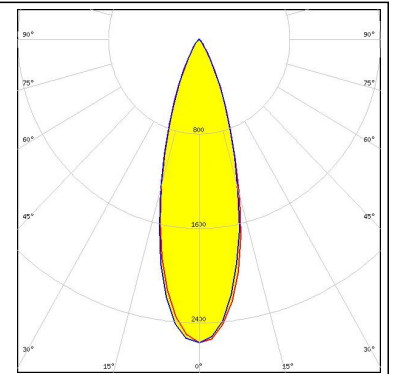
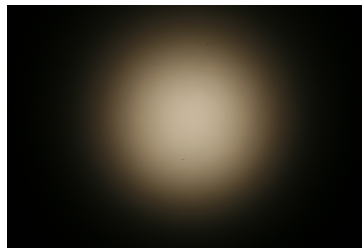

LED LUXEON Z ES
FWHM 32.0°
Efficiency 87 %
Peak intensity 2.6 cd/lm
LEDs/each optic 1
Light colour White
Required components:

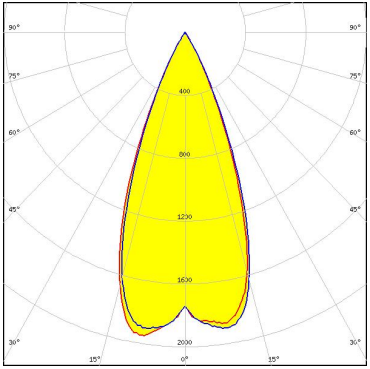

PHOTOMETRIC DATA (SIMULATED):

		
LED	LUXEON T	
FWHM	42.0°	
Efficiency	92 %	
LEDs/each optic	1	
Light colour	White	
Required components:		
		
LED	NCSxx19A	
FWHM	36.0°	
Efficiency	90 %	
LEDs/each optic	1	
Light colour	White	
Required components:		
		
LED	NCSxx19B	
FWHM	36.0°	
Efficiency	92 %	
LEDs/each optic	1	
Light colour	White	
Required components:		
		
LED	NVSxx19A	
FWHM	40.0°	
Efficiency	89 %	
LEDs/each optic	1	
Light colour	White	
Required components:		

PHOTOMETRIC DATA (SIMULATED):



LED NVSxx19B/NVSxx19C
FWHM 41.0°
Efficiency 90 %
LEDs/each optic 1
Light colour White
Required components:



SEOUL SEMICONDUCTOR

LED Z5M
FWHM 38.0°
Efficiency 92 %
LEDs/each optic 1
Light colour White
Required components:

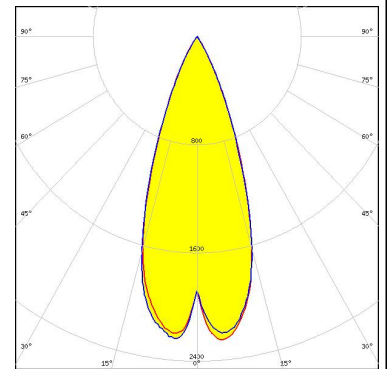

GENERAL INFORMATION:

NOTE: The typical beam angle will be changed by different color, chip size and chip position tolerance. The typical total beam angle is the full angle measured where the luminous intensity is half of the peak value.

MATERIALS:

As part of our continuous research and improvement processes, and to ensure the best possible quality and availability of our products, LEDiL reserves the right to change material grades without notice.

PRODUCT DATA USER AGREEMENT AND DISCLAIMER:

The measured data in the provided downloadable LEDiL Product Datasheets and Mechanical 2D-Drawings is rounded and provided as reference for planning. LEDiL Oy's optical specifications have been verified by conducting performance testing of the products in accordance with the company's quality system. The reported data are averaged results of multiple measurements with typical variation. LEDiL Oy reserves the right to without prior notification make changes and improvements to its products.

LEDiL Oy assumes neither warranty, nor guarantee nor any other liability of any kind for the contents and correctness of the provided data. The provided data has been generated with highest diligence but the provided data may in reality not represent the complete possible variation range of all intrinsic parameters. Therefore, in certain cases a deviation from the provided data could occur.

LEDiL Oy reserves the right to undertake technical changes of its products without further notification which could lead to changes in the provided data. LEDiL Oy assumes no liability of any kind for the possible deviation from any provided data or any other damage resulting from the usage of the provided data.

The user agrees to this disclaimer and user agreement with the download or usage of the provided files.

LEDiL Oy

Joensuunkatu 13
FI-24240 SALO
Finland

LEDiL Inc.

228 West Page Street
Suite D
Sycamore IL 60178
USA

Local sales and technical support

[www.ledil.com/
where_to_buy](http://www.ledil.com/where_to_buy)

Shipping locations

Salo, Finland
Hong Kong, China

Distribution Partners

[www.ledil.com/
where_to_buy](http://www.ledil.com/where_to_buy)

Данный компонент на территории Российской Федерации

Вы можете приобрести в компании MosChip.

Для оперативного оформления запроса Вам необходимо перейти по данной ссылке:

<http://moschip.ru/get-element>

Вы можете разместить у нас заказ для любого Вашего проекта, будь то серийное производство или разработка единичного прибора.

В нашем ассортименте представлены ведущие мировые производители активных и пассивных электронных компонентов.

Нашей специализацией является поставка электронной компонентной базы двойного назначения, продукции таких производителей как XILINX, Intel (ex.ALTERA), Vicor, Microchip, Texas Instruments, Analog Devices, Mini-Circuits, Amphenol, Glenair.

Сотрудничество с глобальными дистрибьюторами электронных компонентов, предоставляет возможность заказывать и получать с международных складов практически любой перечень компонентов в оптимальные для Вас сроки.

На всех этапах разработки и производства наши партнеры могут получить квалифицированную поддержку опытных инженеров.

Система менеджмента качества компании отвечает требованиям в соответствии с ГОСТ Р ИСО 9001, ГОСТ РВ 0015-002 и ЭС РД 009

Офис по работе с юридическими лицами:

105318, г.Москва, ул.Щербаковская д.3, офис 1107, 1118, ДЦ «Щербаковский»

Телефон: +7 495 668-12-70 (многоканальный)

Факс: +7 495 668-12-70 (доб.304)

E-mail: info@moschip.ru

Skype отдела продаж:

moschip.ru

moschip.ru_4

moschip.ru_6

moschip.ru_9