

Ni1000SOT Temperature Sensor

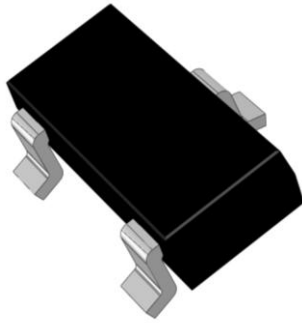

- Contact temperature sensing
- Comply with former DIN 43760 standard
- Small SMD package SOT 23
- Automotive qualified

DESCRIPTION

Ni1000SOT is a nickel thin film resistance temperature detector (RTD) that is suitable for use in contact temperature sensing.

The devices are manufactured by PVD-deposition on a silicon substrate. The thin film structure is covered by a passivation layer for environmental protection and enhanced stability. The nickel elements are mounted on lead frames and encapsulated in SOT23 packages. This technology allows the production of miniature, low cost, high precision temperature sensors.

The characteristics of the temperature sensor comply with the former DIN 43760 standard. It is qualified for the most demanding automotive applications (incl. exposure to hot oil) and is suitable for many more applications in harsh environments.

FEATURES

- Resistance: 1000 ohms at 0°C
- Min/ Max temp -55°C to +160°C
- Good linearity between resistance and temperature (R V's T)
- Large temperature coefficient of resistance: 6178 ppm/K (0°C, 100°C)
- Low power consumption
- Good thermal contact via Pin 3
- Tape and reel (8mm format)

APPLICATIONS

- Temperature sensing, control and compensation
- General instrumentation
- Automotive (VW standard 801-01 vibration)
- Remote sensing

Ni1000SOT Temperature Sensor

PERFORMANCE SPECS

Parameter	Symbol	Condition	Min.	Typ.	Max.	Unit
Basic resistance	R ₀	0°C	997,81	1000	1002,20	Ω
Temperature coefficient of resistance (according to DIN 43760, see below)	TCR	0°C to +100°C	6100	6178	6240	ppm/K
Measurement current	I			0.2	5	mA
Self heating coefficient	EK	+23 °C, still air	1.4	1.7	2	mW/K
Operation temperature	T _{Op}		-55		+160	°C
Maximum resistance drift	ΔR	1000h@150°C		0.1		%
Storage temperature	T _{St}		-55		+160	°C
ESD resistant		MIL 883E3015.7		Class 1		

SELF HEATING EFFECT

For accurate temperature measurement it is recommended to choose a small current to avoid self heating of the nickel sensing element. The temperature error caused by excessive measurement current can be calculated using: $\Delta T = P/EK$

where $P = I^2 \cdot R$ is the power generated by the measurement current and EK is the self heating coefficient.

PACKAGE INFORMATION

Parameter	Condition	Typ.	Unit
Package		SOT23	
Soldering	Reflow to + 260°C	96Sn4Ag	
Packing units		13" (330 mm) / 10000	Reel Size / # of sensors
Package marking		Three Digit code: "1" + "XX", where "XX" is the revision.	

Ni1000SOT Temperature Sensor

TYPICAL PERFORMANCE CURVES

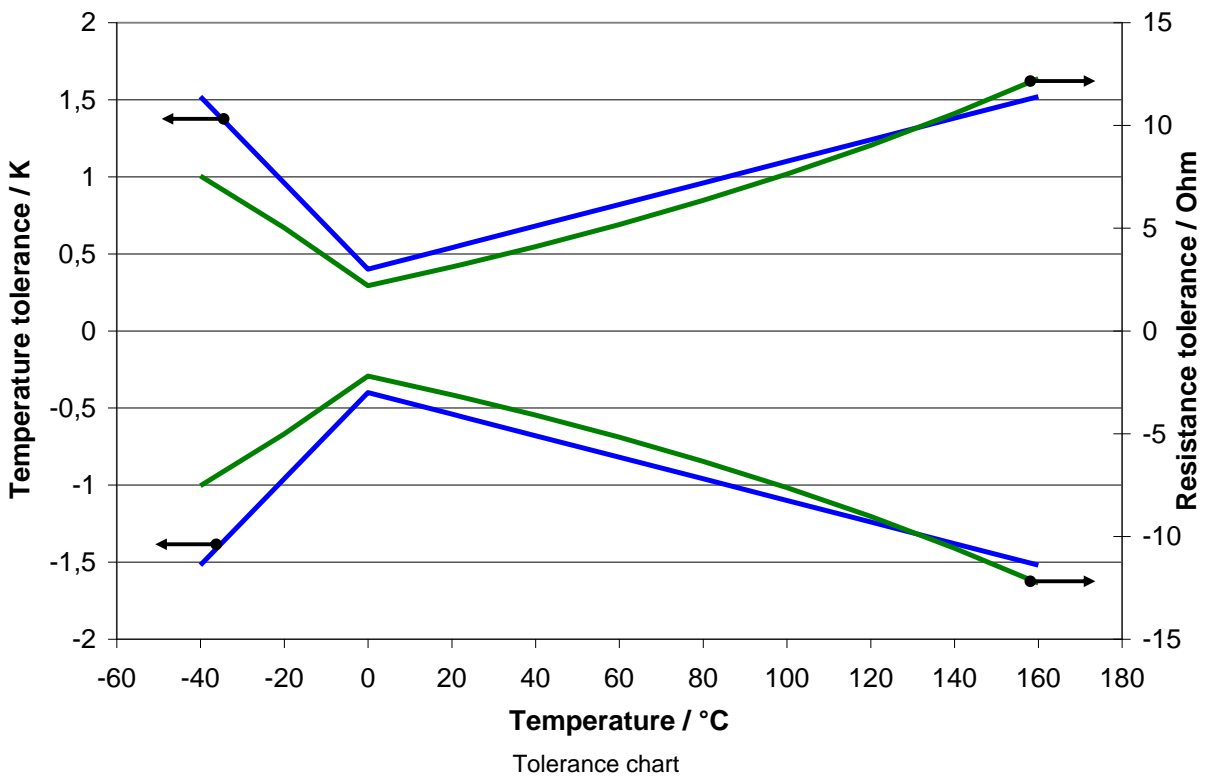
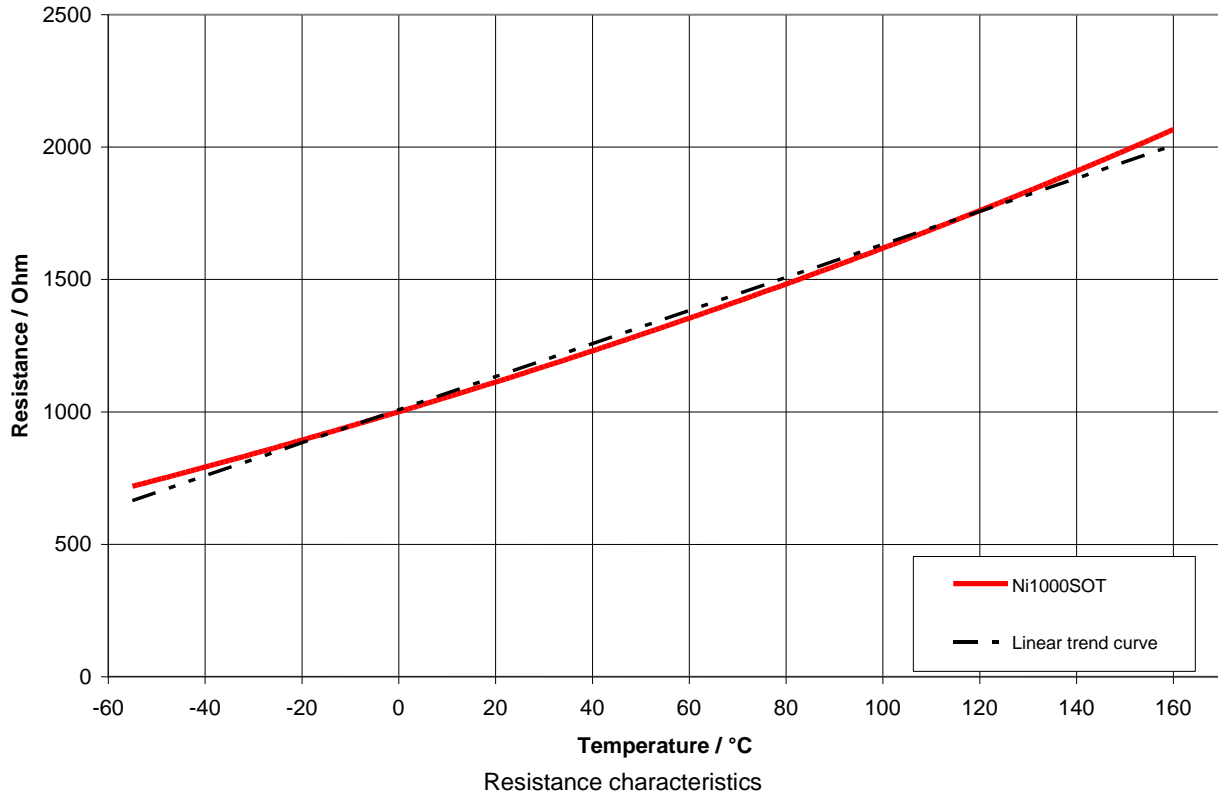

Ni1000SOT Temperature Sensor

ELECTRICAL CHARACTERISTIC

The characteristic of the nickel temperature sensor is specified as per DIN 43760. The large Temperature Coefficient of Resistance (TCR) of the Ni-RTD, 6178 ppm/K, offers greater sensitivity than other types of RTD's. The electrical characteristic can be described by the following equation:

$$R(T) = R_0(1+aT+bT^2+cT^4+dT^6)$$

Coefficients:

$$\begin{aligned} a &= 5.485 \times 10^{-3} \\ b &= 6.650 \times 10^{-6} \\ c &= 2.805 \times 10^{-11} \\ d &= -2.000 \times 10^{-17} \end{aligned}$$

$$T(R) = a' + b'(1+c'R)^{1/2} + d'R^5 + e'R^7 \quad dT < 0.12 \text{ K (higher order equations on request)}$$

Coefficients:

$$\begin{aligned} a' &= -412.6 \\ b' &= 140.41 \\ c' &= 0.00764 \\ d' &= -6.25 \times 10^{-17} \\ e' &= -1.25 \times 10^{-24} \end{aligned}$$

Tolerances: Class B $\pm (0.4+0.007 \times |T|)$ in range from 0°C to +160 °C
 $\pm (0.4+0.028 \times |T|)$ in range from -55°C to 0 °C

T/°C	0	1	2	3	4	5	6	7	8	9
-60	695.2	699.9	704.6	709.3	714.0	718.7	723.4	728.2	733.0	737.8
-50	742.6	747.4	752.2	757.0	761.9	766.8	771.6	776.5	781.4	786.4
-40	791.3	796.3	801.2	806.2	811.2	816.2	821.2	826.3	831.3	836.4
-30	841.5	846.5	851.7	856.8	861.9	867.0	872.2	877.4	882.6	887.8
-20	893.0	898.2	903.4	908.7	913.9	919.2	924.5	929.8	935.1	940.5
-10	945.8	951.2	956.5	961.9	967.3	972.7	978.2	983.6	989.1	994.5
0	1000.0	1005.5	1011.0	1016.5	1022.0	1027.6	1033.1	1038.7	1044.3	1049.9
10	1055.5	1061.1	1066.8	1072.4	1078.1	1083.8	1089.5	1095.2	1100.9	1106.6
20	1112.4	1118.1	1123.9	1129.7	1135.5	1141.3	1147.1	1153.0	1158.8	1164.7
30	1170.6	1176.5	1182.4	1188.3	1194.2	1200.2	1206.1	1212.1	1218.1	1224.1
40	1230.1	1236.1	1242.2	1248.2	1254.3	1260.4	1266.5	1272.6	1278.8	1284.9
50	1291.1	1297.2	1303.4	1309.6	1315.8	1322.0	1328.3	1334.5	1340.8	1347.1
60	1353.4	1359.7	1366.0	1372.4	1378.7	1385.1	1391.5	1397.9	1404.3	1410.8
70	1417.2	1423.7	1430.1	1436.6	1443.1	1449.7	1456.2	1462.8	1469.3	1475.9
80	1482.5	1489.1	1495.7	1502.4	1509.1	1515.7	1522.4	1529.1	1535.9	1542.6
90	1549.3	1556.1	1562.9	1569.7	1576.5	1583.4	1590.2	1597.1	1604.0	1610.9
100	1617.8	1624.7	1631.7	1638.6	1645.6	1652.6	1659.6	1666.7	1673.7	1680.8
110	1687.9	1695.0	1702.1	1709.3	1716.4	1723.6	1730.8	1738.0	1745.2	1752.5
120	1759.7	1767.0	1774.3	1781.6	1788.9	1796.3	1803.7	1811.1	1818.5	1825.9
130	1833.3	1840.8	1848.3	1855.8	1863.3	1870.9	1878.4	1886.0	1893.6	1901.2
140	1908.9	1916.5	1924.2	1931.9	1939.6	1947.4	1955.1	1962.9	1970.7	1978.5
150	1986.3	1994.2	2002.1	2010.0	2017.9	2025.9	2033.8	2041.8	2049.8	2057.8
160	2065.9	2074.0	2082.1	2090.2	2098.3	2106.5	2114.6	2122.8	2131.1	2139.3

Ni1000SOT Temperature Sensor

MECHANICAL DIMENSIONS

PACKAGE DIMENSIONS SOT23

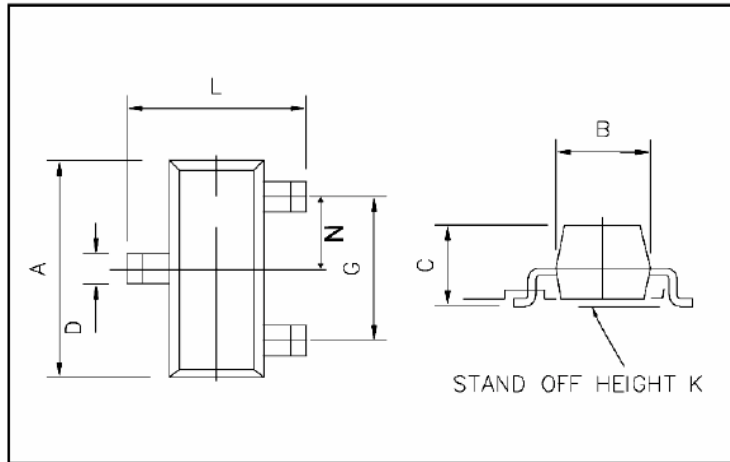

DIM	Millimeters		Inches	
	Min	Max	Min	Max
A	2.67	3.05	0.1051	0.1201
B	1.20	1.40	0.0472	0.0551
C	0.89	1.12	0.0350	0.0441
D	0.37	0.53	0.0146	0.0209
G	1.78	2.05	0.0701	0.0807
K	0.01	0.10	0.0004	0.0039
L	2.10	2.64	0.0827	0.1039
N	0.89	1.03	0.0350	0.0406

PIN DIMENSIONS

Dimension	Millimeters		Inches	
	Min	Max	Min	Max
Pin Thickness	0.085	0.18	0.0033	0.0071

CONNECTIONS

<p>Top view:</p>	Pin # 1	Nickel RTD electrical contact
	Pin # 2	Nickel RTD electrical contact
	Pin # 3	Electrically isolated thermal contact

Ni1000SOT Temperature Sensor

APPLICATION NOTE 1

Analogue Interface Circuit for general purpose measurement

The following voltage dividing circuit can be used for low accuracy measurements. There is no linearization given.

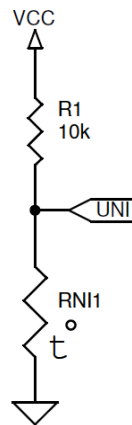

Example of voltage dividing circuit using Ni1000SOT sensor

The output voltage will be calculated by the following equation:

$$UNI = RN1 / (R1 + RN1) \cdot VCC$$

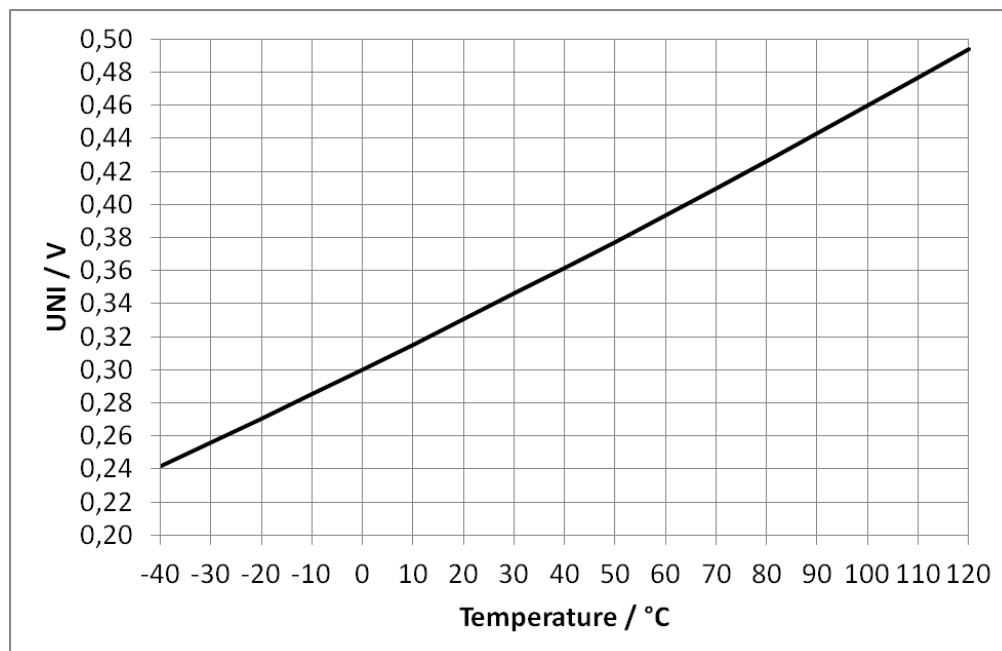

Output voltage characteristics with VCC = 3.3V

Ni1000SOT Temperature Sensor

APPLICATION NOTE 2

Analogue Interface Circuit for high accuracy measurement

The following circuitry utilizes the output of a bridge circuitry which is amplified in order to improve the measurement resolution. By bridging RNI with an optional 3.65kOhm resistor this circuitry can be linearized.

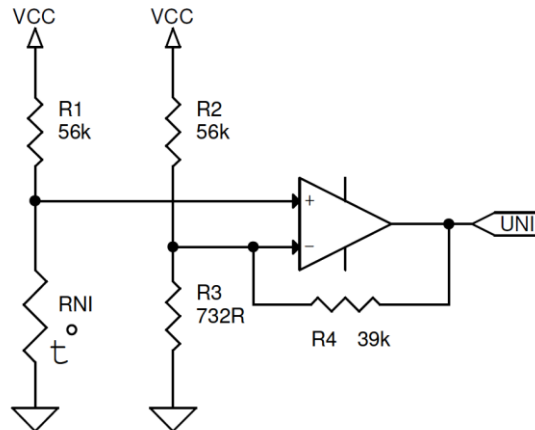

Example of analog interface circuit for high accuracy measurement using Ni1000SOT sensor

The output voltage will be calculated by the following equation:

$$UNI = RNI/(R1+RNI) \cdot VCC \cdot [1 + R4 \cdot (1/R2 + 1/R3)] - R4/R2 \cdot VCC$$

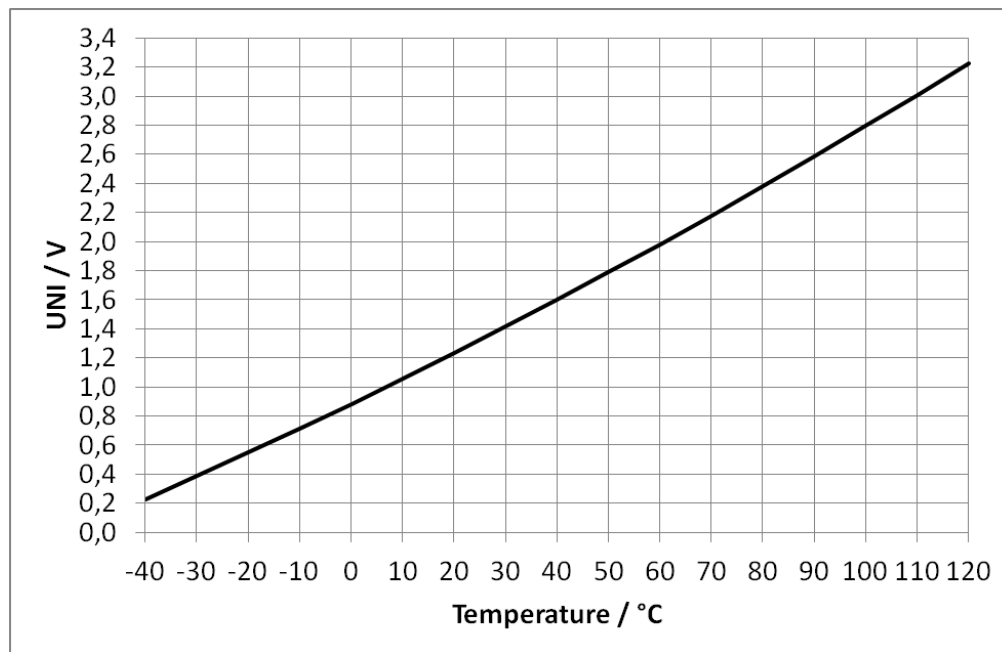

Output voltage characteristics with VCC = 3.3V

Ni1000SOT Temperature Sensor

ORDER INFORMATION

Please order this product using following:

Part Number	Part Description
G-NICO-001	Ni1000SOT

DEFINITIONS AND DISCLAIMERS

- Application information – Applications that are described herein for any of these products are for illustrative purpose only. MEAS Deutschland GmbH makes no representation or warranty that such applications will be suitable for the specified use without further testing or modification.
- Life support applications – These products are not designed for use in life support appliances, devices, or systems where malfunctions of these products can reasonably be expected to result in personal injury.
MEAS Deutschland GmbH customers using or selling this product for use in such applications do so at their own risk and agree to fully indemnify MEAS Deutschland GmbH for any damages resulting from such improper use or sale.

TECHNICAL CONTACT INFORMATION

NORTH AMERICA	EUROPE	ASIA
Measurement Specialties, Inc. 910 Turnpike Road Shrewsbury, MA 01545 United States Phone: +1-508-842-0516 Fax: +1-508-842-0342 Email: temperature.sales.amer@meas-spec.com Web: www.meas-spec.com	MEAS Deutschland GmbH Hauert 13 D-44227 Dortmund Germany Phone: +49-(0)231-9740-0 Fax: +49-(0)231-9740-20 Email: info.de@meas-spec.com Web: www.meas-spec.com	Measurement Specialties China Ltd. No. 26, Langshan Road High-tech Park (North) Nanshan District, Shenzhen 518057 China Phone: +86-755-33305088 Fax: +86-755-33305099 Email: temperature.sales.asia@meas-spec.com Web: www.meas-spec.com

The information in this sheet has been carefully reviewed and is believed to be accurate; however, no responsibility is assumed for inaccuracies. Furthermore, this information does not convey to the purchaser of such devices any license under the patent rights to the manufacturer. Measurement Specialties, Inc. reserves the right to make changes without further notice to any product herein. Measurement Specialties, Inc. makes no warranty, representation or guarantee regarding the suitability of its product for any particular purpose, nor does Measurement Specialties, Inc. assume any liability arising out of the application or use of any product or circuit and specifically disclaims any and all liability, including without limitation consequential or incidental damages. Typical parameters can and do vary in different applications. All operating parameters must be validated for each customer application by customer's technical experts. Measurement Specialties, Inc. does not convey any license under its patent rights nor the rights of others.

Данный компонент на территории Российской Федерации

Вы можете приобрести в компании MosChip.

Для оперативного оформления запроса Вам необходимо перейти по данной ссылке:

<http://moschip.ru/get-element>

Вы можете разместить у нас заказ для любого Вашего проекта, будь то серийное производство или разработка единичного прибора.

В нашем ассортименте представлены ведущие мировые производители активных и пассивных электронных компонентов.

Нашей специализацией является поставка электронной компонентной базы двойного назначения, продукции таких производителей как XILINX, Intel (ex.ALTERA), Vicor, Microchip, Texas Instruments, Analog Devices, Mini-Circuits, Amphenol, Glenair.

Сотрудничество с глобальными дистрибьюторами электронных компонентов, предоставляет возможность заказывать и получать с международных складов практически любой перечень компонентов в оптимальные для Вас сроки.

На всех этапах разработки и производства наши партнеры могут получить квалифицированную поддержку опытных инженеров.

Система менеджмента качества компании отвечает требованиям в соответствии с ГОСТ Р ИСО 9001, ГОСТ РВ 0015-002 и ЭС РД 009

Офис по работе с юридическими лицами:

105318, г.Москва, ул.Щербаковская д.3, офис 1107, 1118, ДЦ «Щербаковский»

Телефон: +7 495 668-12-70 (многоканальный)

Факс: +7 495 668-12-70 (доб.304)

E-mail: info@moschip.ru

Skype отдела продаж:

moschip.ru

moschip.ru_4

moschip.ru_6

moschip.ru_9