



BTA06T-600CWRG

6 A Snubberless™ Triac

Features

- High static and dynamic commutation
- BTA series is UL1557 certified (File ref.: 81734)
- Package is RoHS (2002/95/EC) compliant
- $I_{GT} = 35 \text{ mA}$

Applications

Specially designed for power tool applications, it can also be used to drive loads like motor speed controller, kitchen equipments such as electro valves, light dimmers and similar.

Description

Available in through-hole package, the Triac BTA06T-600CW is suitable for general purpose ac switching.

Being a fully insulated package, the BTA06T-600CW provides insulation rated at 2500 V rms.

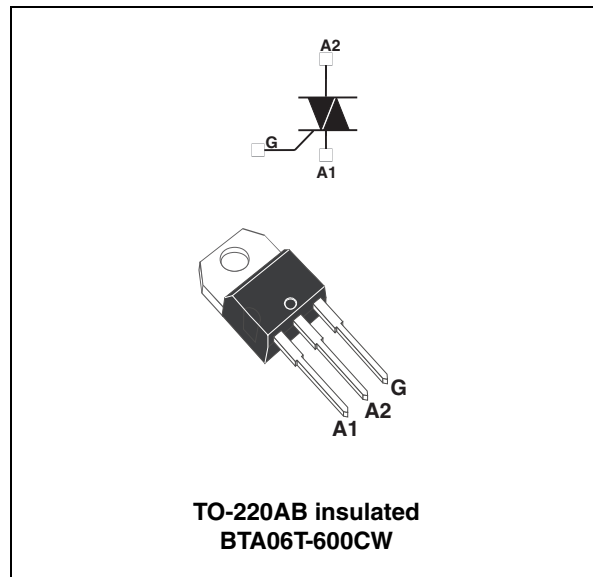

TM: Snubberless is a trademark of STMicroelectronics

1 Characteristics

Table 1. Absolute maximum ratings (limiting values)

| Symbol | Parameter | | Value | Unit | |
|-------------------|---|-------------------------|-----------------------|-------------------------|------------------|
| $I_{T(RMS)}$ | On-state rms current (full sine wave) | | $T_c = 100\text{ °C}$ | 6 | A |
| I_{TSM} | Non repetitive surge peak on-state current (full cycle sine wave, T_j initial = 25 °C) | F = 60 Hz | t = 16.7 ms | 47 | A |
| | | F = 50 Hz | t = 20 ms | 45 | |
| I^2t | I^2t Value for fusing | $t_p = 10\text{ ms}$ | | 13 | A ² s |
| dI/dt | Critical rate of rise of on-state current $I_G = 2 \times I_{GT}$, $t_r \leq 100\text{ ns}$ | F = 120 Hz | $T_j = 125\text{ °C}$ | 50 | A/ μ s |
| V_{DSM}/V_{RSM} | Non repetitive surge peak off-state voitage | $t_p = 10\text{ ms}$ | $T_j = 25\text{ °C}$ | $V_{DRM}/V_{RRM} + 100$ | V |
| I_{GM} | Peak gate current | $t_p = 20\text{ }\mu$ s | $T_j = 125\text{ °C}$ | 4 | A |
| $P_{G(AV)}$ | Average gate power dissipation | | $T_j = 125\text{ °C}$ | 1 | W |
| T_{stg} | Storage junction temperature range | | | -40 to +150 | °C |
| T_j | Operating junction temperature range | | | -40 to +125 | |

Table 2. Electrical characteristics, Snubberless (3 quadrants) ($T_j = 25\text{ °C}$, unless otherwise specified)

| Symbol | Test conditions | Quadrant | | Value | Unit |
|-------------------------------------|---|--------------|-----|-------|------------|
| $I_{GT}^{(1)}$ | $V_D = 12\text{ V}$ $R_L = 30\text{ }\Omega$ | I - II - III | MAX | 35 | mA |
| V_{GT} | $V_D = 12\text{ V}$ $R_L = 30\text{ }\Omega$ | I - II - III | MAX | 1.3 | V |
| V_{GD} | $V_D = V_{DRM}$ $R_L = 3.3\text{ k}\Omega$ | I - II - III | MIN | 0.2 | V |
| $I_H^{(2)}$ | $I_T = 100\text{ mA}$ | | MAX | 35 | mA |
| I_L | $I_G = 1.2 \times I_{GT}$ | I - III | MAX | 50 | mA |
| | | II | | 80 | |
| dV/dt ⁽²⁾ | $V_D = 67\% V_{DRM}$, gate open, $T_j = 125\text{ °C}$ | | MIN | 750 | V/ μ s |
| (dI/dt) _C ⁽²⁾ | Without snubber, $T_j = 125\text{ °C}$ | | MIN | 8.0 | A/ms |

1. Minimum I_{GT} is guaranteed at 5% of I_{GT} max.
2. For both polarities of A2 pin referenced to A1 pin

Table 3. Static electrical characteristics

| Symbol | Test conditions | | Value | Unit | | |
|------------------------|--|-----------------------|-----------------------|------|---------|------------|
| $V_{TM}^{(1)}$ | $I_{TM} = 8.5\text{ A}$, $t_p = 380\text{ }\mu$ s | $T_j = 25\text{ °C}$ | MAX | 1.6 | V | |
| $V_{TO}^{(1)}$ | Threshold voltage | | $T_j = 125\text{ °C}$ | MAX | 0.85 | V |
| $R_D^{(1)}$ | Dynamic resistance | | $T_j = 125\text{ °C}$ | MAX | 80 | m Ω |
| I_{DRM} I_{RRM} | $V_{DRM} = V_{RRM}$ | $T_j = 25\text{ °C}$ | MAX | 5 | μ A | |
| | | $T_j = 125\text{ °C}$ | | 1 | mA | |

1. For both polarities of A2 pin referenced to A1 pin

Table 4. Thermal resistances

| Symbol | Parameter | Value | Unit |
|---------------|-----------------------|-------|------|
| $R_{th(j-c)}$ | Junction to case (ac) | 3.4 | °C/W |
| $R_{th(j-a)}$ | Junction to ambient | 60 | |

Figure 1. Maximum power dissipation versus rms on-state current (full cycle)

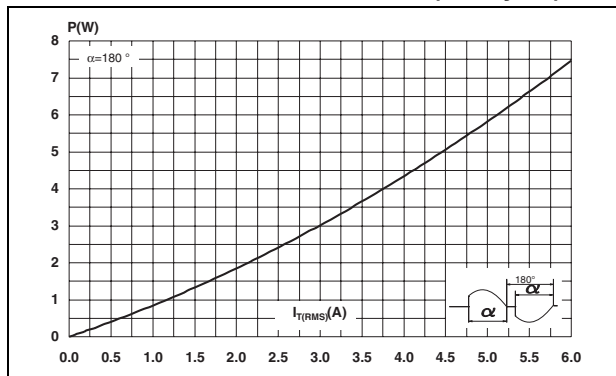

Figure 2. On-state current (rms) versus case temperature (full cycle)

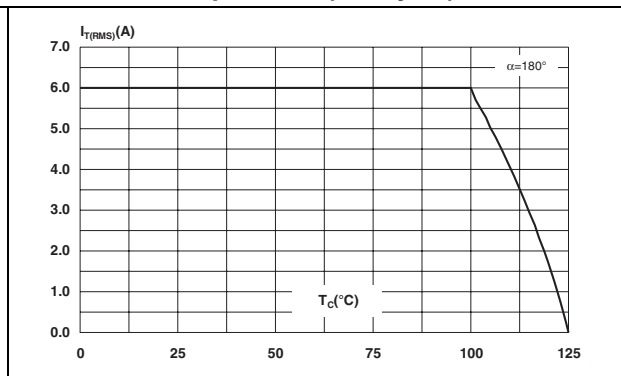

Figure 3. On-state current (rms) versus ambient temperature (free air convection)

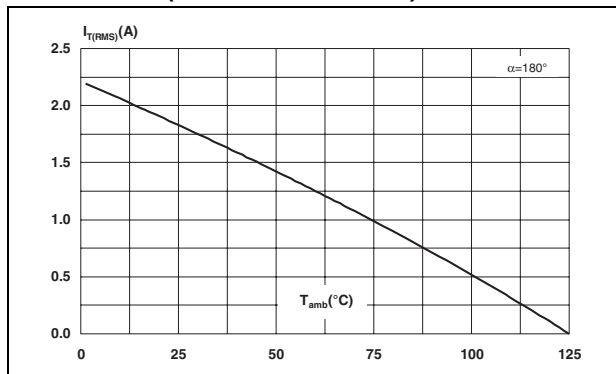

Figure 4. Relative variation of thermal impedance versus pulse duration

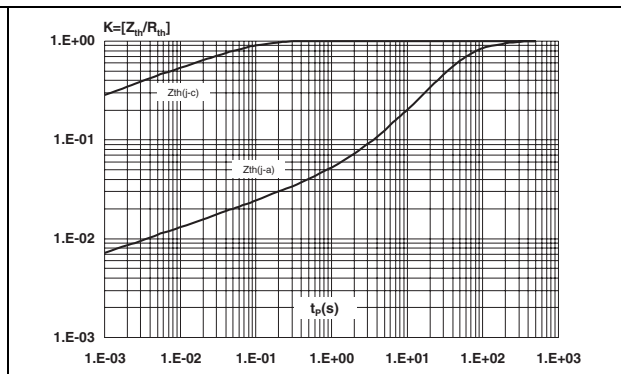

Figure 5. Relative variation of gate trigger current, and gate trigger voltage versus junction temperature

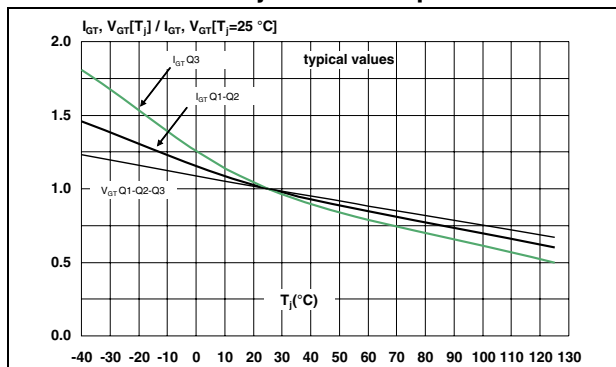

Figure 6. Relative variation of holding current and latching current versus junction temperature

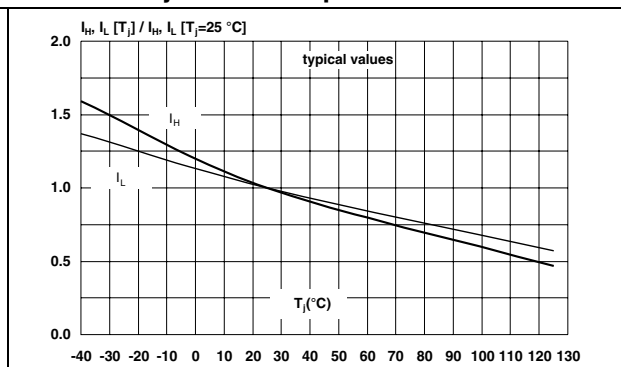

Figure 7. Surge peak on-state current versus number of cycles

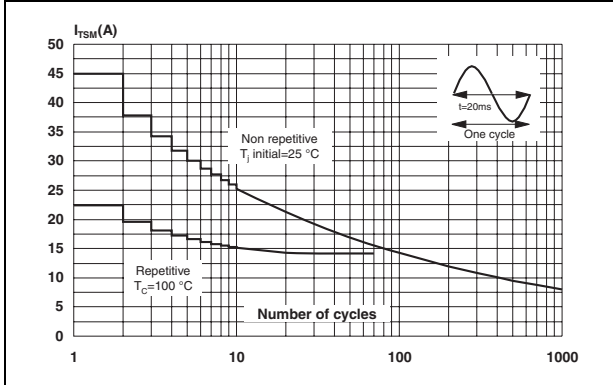

Figure 8. Non-repetitive surge peak on-state current for sinusoidal

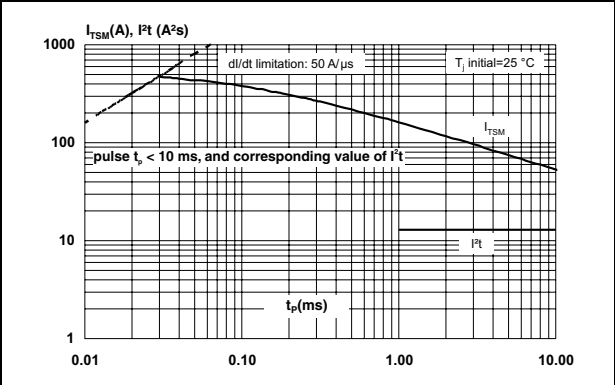

Figure 9. On-state characteristics (maximum values)

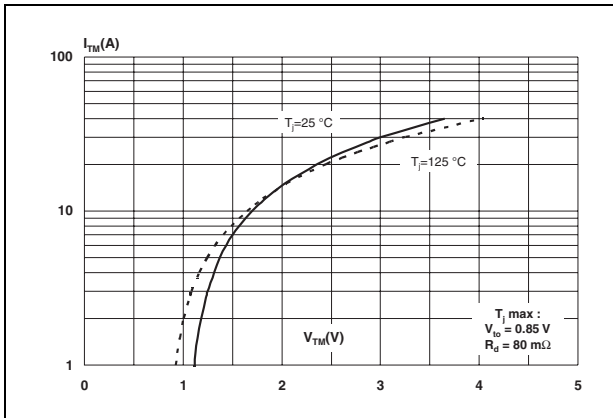

Figure 10. Relative variation of critical rate of decrease of main current (di/dt)c versus junction temperature

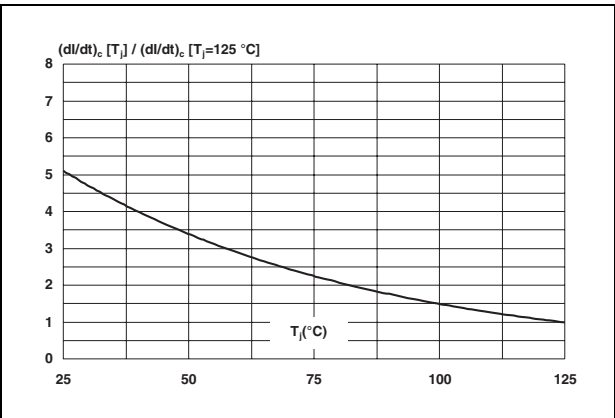

Figure 11. Relative variation of critical rate of decrease of main current (di/dt)c versus reapplied (dV/dt)c

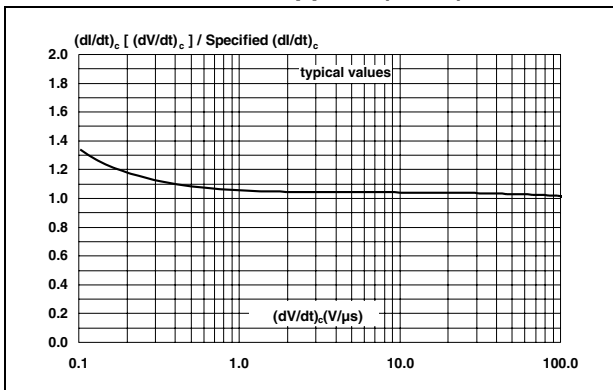
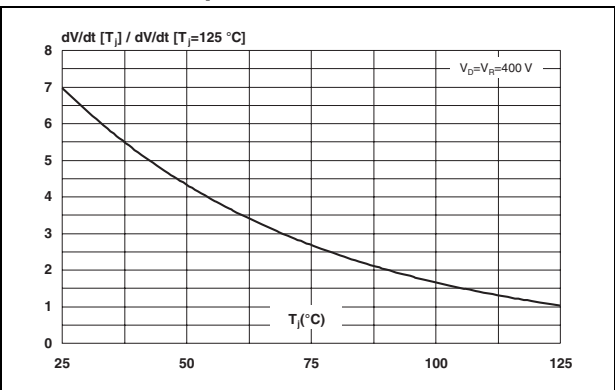
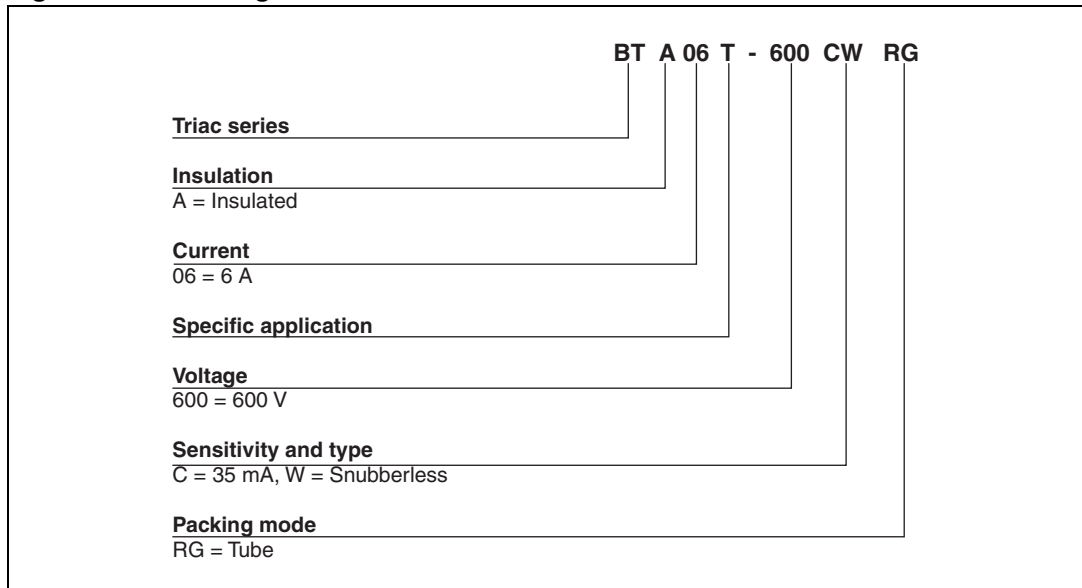

Figure 12. Relative variation of static dV/dt immunity versus junction temperature



2 Ordering information

Figure 13. Ordering information scheme



3 Package information

- Epoxy meets UL94, V0
- Lead-free packages

In order to meet environmental requirements, ST offers these devices in different grades of ECOPACK® packages, depending on their level of environmental compliance. ECOPACK® specifications, grade definitions and product status are available at: www.st.com. ECOPACK® is an ST trademark.

Table 5. TO-220AB insulated dimensions

| Ref. | Dimensions | | | | | |
|------|-------------|-------|-------|--------|-------|-------|
| | Millimeters | | | Inches | | |
| | Min. | Typ. | Max. | Min. | Typ. | Max. |
| A | 15.20 | | 15.90 | 0.598 | | 0.625 |
| a1 | | 3.75 | | | 0.147 | |
| a2 | 13.00 | | 14.00 | 0.511 | | 0.551 |
| B | 10.00 | | 10.40 | 0.393 | | 0.409 |
| b1 | 0.61 | | 0.88 | 0.024 | | 0.034 |
| b2 | 1.23 | | 1.32 | 0.048 | | 0.051 |
| C | 4.40 | | 4.60 | 0.173 | | 0.181 |
| c1 | 0.49 | | 0.70 | 0.019 | | 0.027 |
| c2 | 2.40 | | 2.72 | 0.094 | | 0.107 |
| e | 2.40 | | 2.70 | 0.094 | | 0.106 |
| F | 6.20 | | 6.60 | 0.244 | | 0.259 |
| ØI | 3.75 | | 3.85 | 0.147 | | 0.151 |
| I4 | 15.80 | 16.40 | 16.80 | 0.622 | 0.646 | 0.661 |
| L | 2.65 | | 2.95 | 0.104 | | 0.116 |
| I2 | 1.14 | | 1.70 | 0.044 | | 0.066 |
| I3 | 1.14 | | 1.70 | 0.044 | | 0.066 |
| M | | 2.60 | | | 0.102 | |

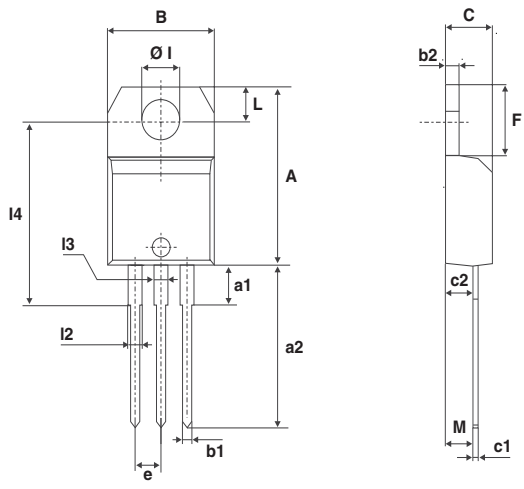

4 Ordering information

Table 6. Ordering information

| Order code | Marking | Package | Weight | Base qty | Packing mode |
|----------------|--------------|--------------|--------|----------|--------------|
| BTA06T-600CWRG | BTA06T-600CW | TO-220AB ins | 2.3 g | 50 | Tube |

5 Revision history

Table 7. Document revision history

| Date | Revision | Changes |
|-------------|----------|--|
| 15-Nov-2007 | 1 | Initial release. |
| 17-Jun-2010 | 2 | Updated title on page 1 . Updated ECOPACK statement. |

Please Read Carefully:

Information in this document is provided solely in connection with ST products. STMicroelectronics NV and its subsidiaries ("ST") reserve the right to make changes, corrections, modifications or improvements, to this document, and the products and services described herein at any time, without notice.

All ST products are sold pursuant to ST's terms and conditions of sale.

Purchasers are solely responsible for the choice, selection and use of the ST products and services described herein, and ST assumes no liability whatsoever relating to the choice, selection or use of the ST products and services described herein.

No license, express or implied, by estoppel or otherwise, to any intellectual property rights is granted under this document. If any part of this document refers to any third party products or services it shall not be deemed a license grant by ST for the use of such third party products or services, or any intellectual property contained therein or considered as a warranty covering the use in any manner whatsoever of such third party products or services or any intellectual property contained therein.

UNLESS OTHERWISE SET FORTH IN ST'S TERMS AND CONDITIONS OF SALE ST DISCLAIMS ANY EXPRESS OR IMPLIED WARRANTY WITH RESPECT TO THE USE AND/OR SALE OF ST PRODUCTS INCLUDING WITHOUT LIMITATION IMPLIED WARRANTIES OF MERCHANTABILITY, FITNESS FOR A PARTICULAR PURPOSE (AND THEIR EQUIVALENTS UNDER THE LAWS OF ANY JURISDICTION), OR INFRINGEMENT OF ANY PATENT, COPYRIGHT OR OTHER INTELLECTUAL PROPERTY RIGHT.

UNLESS EXPRESSLY APPROVED IN WRITING BY AN AUTHORIZED ST REPRESENTATIVE, ST PRODUCTS ARE NOT RECOMMENDED, AUTHORIZED OR WARRANTED FOR USE IN MILITARY, AIR CRAFT, SPACE, LIFE SAVING, OR LIFE SUSTAINING APPLICATIONS, NOR IN PRODUCTS OR SYSTEMS WHERE FAILURE OR MALFUNCTION MAY RESULT IN PERSONAL INJURY, DEATH, OR SEVERE PROPERTY OR ENVIRONMENTAL DAMAGE. ST PRODUCTS WHICH ARE NOT SPECIFIED AS "AUTOMOTIVE GRADE" MAY ONLY BE USED IN AUTOMOTIVE APPLICATIONS AT USER'S OWN RISK.

Resale of ST products with provisions different from the statements and/or technical features set forth in this document shall immediately void any warranty granted by ST for the ST product or service described herein and shall not create or extend in any manner whatsoever, any liability of ST.

ST and the ST logo are trademarks or registered trademarks of ST in various countries.

Information in this document supersedes and replaces all information previously supplied.

The ST logo is a registered trademark of STMicroelectronics. All other names are the property of their respective owners.

© 2010 STMicroelectronics - All rights reserved

STMicroelectronics group of companies

Australia - Belgium - Brazil - Canada - China - Czech Republic - Finland - France - Germany - Hong Kong - India - Israel - Italy - Japan - Malaysia - Malta - Morocco - Philippines - Singapore - Spain - Sweden - Switzerland - United Kingdom - United States of America

www.st.com

Данный компонент на территории Российской Федерации

Вы можете приобрести в компании MosChip.

Для оперативного оформления запроса Вам необходимо перейти по данной ссылке:

<http://moschip.ru/get-element>

Вы можете разместить у нас заказ для любого Вашего проекта, будь то серийное производство или разработка единичного прибора.

В нашем ассортименте представлены ведущие мировые производители активных и пассивных электронных компонентов.

Нашей специализацией является поставка электронной компонентной базы двойного назначения, продукции таких производителей как XILINX, Intel (ex.ALTERA), Vicor, Microchip, Texas Instruments, Analog Devices, Mini-Circuits, Amphenol, Glenair.

Сотрудничество с глобальными дистрибьюторами электронных компонентов, предоставляет возможность заказывать и получать с международных складов практически любой перечень компонентов в оптимальные для Вас сроки.

На всех этапах разработки и производства наши партнеры могут получить квалифицированную поддержку опытных инженеров.

Система менеджмента качества компании отвечает требованиям в соответствии с ГОСТ Р ИСО 9001, ГОСТ РВ 0015-002 и ЭС РД 009

Офис по работе с юридическими лицами:

105318, г.Москва, ул.Щербаковская д.3, офис 1107, 1118, ДЦ «Щербаковский»

Телефон: +7 495 668-12-70 (многоканальный)

Факс: +7 495 668-12-70 (доб.304)

E-mail: info@moschip.ru

Skype отдела продаж:

moschip.ru

moschip.ru_4

moschip.ru_6

moschip.ru_9