

PRODUCT PERFORMANCE STANDARDS

OMRON devices that comply with EC Directives also conform to the related EMC standards so that they can be more easily built into other devices or the overall machine. The actual products have been checked for conformity to EMC standards (see the following note). Whether the products conform to the standards in the system used by the customer, however, must be confirmed by the customer.

EMC-related performance of the OMRON devices that comply with EC Directives will vary depending on the configuration, wiring, and other conditions of the equipment or control panel on which the OMRON devices are installed. The customer must, therefore, perform the final check to confirm that devices and the overall machine conform to EMC standards.

Applicable EMC Standards

EMS (Electromagnetic Susceptibility): EN61131-2

EMI (Electromagnetic Interference): EN50081-2

(Radiated emission: 10-m regulations)

OMRON Power Supply Modules and I/O Modules have been determined safe when operating at voltages of 50 to 1,000 VAC and 75 to 1,500 VDC according to the safety standards in EN61131-2.

Standards Description

U = UL, Underwriters Laboratories, Inc.

C = CSA, Canadian Standards Association

CE = CE, CE Marking

N = Nemko, Norges Elektriske Materiekkontroll

L = Lloyd's Register of shipping

Special Note: For current consumption, refer to *Current Consumption Tables* (the last 6 pages of this ordering guide).

CPU Rack	147
Expansion Racks	148
C200H Basic I/O Modules	149
B7A Terminals	
Link Master Adapters for High-density I/O PLC Modules	
C200H High-density I/O Modules	153
Connectors for C200H High-density I/O Modules	
C200H Group-2 High-density I/O Modules	154
Connectors for C200H Group-2 High-density I/O Modules	
CS1 High-density I/O Modules	155
Connectors for CS1 High-density I/O Modules	
High-density I/O Screw Terminal Blocks and Cables	156
Screw Terminal Block and Cables	
High-density I/O Relay Blocks, Bases and Dedicated Cables	157
G7TC Relay Blocks	
P7TF Block Bases and I/O Relays	
Accessories	
Relay Output Blocks	
Relay Terminal Block Bases	
Relays for use with G70A Bases	
Dedicated Connecting Cable for Omron PLC Modules	
C200H Special I/O Modules	160
CS1 Special I/O Modules	165
CS1/C200H Non-compatible Modules	167
Modules not compatible with CS1 Controllers or Systems	
CS1 Communications and Network Modules	168
Communications and Network Modules	
Fiber-Optic Cables and Connectors for Controller Link	
DeviceNet Products	169
DeviceNet Multiple I/O Terminal Modules	170
DeviceNet Communications Module	
Digital I/O Modules	
Relay Output Modules	
Analog I/O Modules	
Counter Module	
CompoBus/S Slave Modules	171
Long Distance CompoBus/S Slave Modules (NEW!)	172
Optional Products	173
Module Accessories	
Mounting Rails and Accessories	
Current Consumption Tables	174
CPU Racks and Expansion Racks	
SYSMAC BUS Slave Racks	
Example Calculations	
5 VDC Voltage Group	176
Basic I/O Modules	
High-density I/O Modules (Special I/O)	
Special I/O Modules	
CS1 CPU BUS Modules	
26 VDC Modules	181

System Overview

CPU Overview

Basic System Configuration

I/O Types and Allocations







Modules

Peripheral Hardware and Software

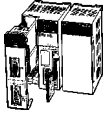
Instruction Set



Ordering Guide

Reference Information







Item	Description			Standards	Part number
 <p>CPU Modules</p>	I/O bits	Program capacity	Data memory capacity	—	—
	960	10K steps	32K words (DM: 32K words, EM: None)	U, C, N, CE, L	CS1G-CPU42-E(V□)
	960	20K steps	32K words (DM: 32K words, EM: None)		CS1G-CPU43-E(V□)
	1280	30K steps	64K words (DM: 32K words, EM: 32K words × 1 bank)		CS1G-CPU44-E(V□)
	5120	60K steps	128K words (DM: 32K words, EM: 32K words × 3 banks)		CS1G-CPU45-E(V□)
	5120	20K steps	32K words (DM: 32K words, EM: None)		CS1H-CPU63-E(V□)
	5120	30K steps	64K words (DM: 32K words, EM: 32K words × 1 bank)		CS1H-CPU64-E(V□)
	5120	60K steps	128K words (DM: 32K words, EM: 32K words × 3 banks)		CS1H-CPU65-E(V□)
	5120	120K steps	256K words (DM: 32K words, EM: 32K words × 7 banks)		CS1H-CPU66-E(V□)
5120	250K steps	448K words (DM: 32K words, EM: 32K words × 13 banks)	CS1H-CPU67-E(V□)		
 <p>CPU Racks</p>	2 slots (does not connect to Expansion Rack)			U, C, N, CE, L	CS1W-BC023
	3 slots				CS1W-BC033
	5 slots				CS1W-BC053
	8 slots				CS1W-BC083
	10 slots				CS1W-BC103
 <p>Power Supplies</p>	100 to 120 VAC or 200 to 240 VAC; output capacity: 4.6 A, 5 VDC			U, C, N, L, CE	C200HW-PA204
	100 to 120 VAC or 200 to 240 VAC (with 0.8 A, 24 VDC service power supply) Output capacity: 4.6 A, 5 VDC				C200HW-PA204S
	100 to 120 VAC or 200 to 240 VAC (with RUN output) Output capacity: 4.6 A, 5 VDC			U, C	C200HW-PA204R
	100 to 120 VAC or 200 to 240 VAC (with RUN output) Output capacity: 9 A, 5 VDC			CE, L	C200HW-PA209R
	24 VDC, Output capacity: 4.6 A, 5 VDC			U, C, N, L, CE	C200HW-PD024
 <p>Memory Cards</p>	Flash memory, 8 MB			CE, L	HMC-EF861
	Flash memory, 15 MB				HMC-EF171
	Flash memory, 30 MB				HMC-EF371
	Memory Card adapter				HMC-AP001
<p>Serial Communications Boards</p>	2 × RS-232C ports (protocol macro function supported)			U, C, N, CE, L	CS1W-SCB21
	1 × RS-232C port + 1 × RS-422/485 port (protocol macro function supported)				CS1W-SCB41
 <p>Programming Consoles</p>	Requires an English Keyboard Sheet (CS1W-KS001-E). (connects to the peripheral port on CPU Module only)			U, C, N, CE,	CQM1-PRO01-E
					C200H-PRO27-E
 <p>Programming Console Connecting Cables</p>	Connects the CQM1-PRO01-E Programming Console. (0.05 m length) (adapter cable used with cable included with COM-PRO01-E)			CE	CS1W-CN114
	Connects the C200H-PRO27-E Programming Console. (2.0 m length)				CS1W-CN224
	Connects the C200H-PRO27-E Programming Console. (6.0 m length)				CS1W-CN624
CX-Programmer Software	Windows-based Programming Software for Windows 95, 98, NT4.0 (connects to peripheral port on CPU Module or RS-232C port on CPU Module or Serial Communications Module/Board.)			—	WS02-CXPC1-EV□□
CX-Protocol	Windows-based Protocol Development Software for Windows 95, 98, NT4.0			—	WS02-PSTC1-E
<p>Peripheral Device Connecting Cables (for peripheral port)</p>	Connects Standard IBM PC/AT compatible computers D-Sub 9-pin receptacle (Length: 0.1 m)			CE	CS1W-CN118 (See Note.)
	Connects Standard IBM PC/AT compatible computers D-Sub 9-pin (2.0 m length)				CS1W-CN226
	Connects Standard IBM PC/AT compatible computers D-Sub 9-pin (6.0 m length)				CS1W-CN626
Peripheral Device Connecting Cables (for RS-232C port)	Serial Connecting Cable Connects Standard IBM PC/AT compatible computers D-Sub 9-pin (2.0 m length)			—	C200HS-CN220-EU
Battery Set	For CS1 Series only; provides backup to CPU memory			CE, L	CS1W-BAT01

Note: This is an adapter cable that is to be used with Omron Cable No. C200HS-CN220EU.

Expansion Racks





Item	Description	Standards	Part number	
	3 slots	U, C, N, CE	CS1W-BI033	
	5 slots		CS1W-BI053	
	8 slots		CS1W-BI083	
	10 slots		CS1W-BI103	
	3 slots	U, C, N, L, CE	C200HW-BI031	
	5 slots		C200HW-BI051	
	8 slots		C200HW-BI081	
	10 slots		C200HW-BI101	
	100 to 120 VAC or 200 to 240 VAC, Output capacity: 4.6 A, 5 VDC	U, C, N, L, CE	C200HW-PA204	
	100 to 120 VAC or 200 to 240 VAC (with service supply: 0.8 A, 24 VDC), Output capacity: 4.6 A, 5 VDC		C200HW-PA204S	
	100 to 120 VAC or 200 to 240 VAC (with RUN output) Output capacity: 4.6 A, 5 VDC	U, C	C200HW-PA204R	
	24 VDC, 19.2 to 23.8 VDC Output capacity: 4.6A, 5 VDC	U, C, N, L, CE	C200HW-PD024	
	100 to 120 VAC or 200 to 240 VAC (with RUN output) Output capacity: 9 A, 5 VDC	CE, L	C200HW-PA209R	
CS1 to CS1 Expansion I/O Rack Connecting Cables	Connects CS1 Expansion I/O Racks to CPU (CS1) Racks or other CS1 Expansion I/O Racks.	Length: 0.3 m	—	CS1W-CN313
		Length: 0.7 m		CS1W-CN713
		Length: 2 m		CS1W-CN223
		Length: 3 m		CS1W-CN323
		Length: 5 m		CS1W-CN523
		Length: 10 m		CS1W-CN133
		Length: 12 m		CS1W-CN133-B2
CS1 to C200HW Expansion I/O Rack Connecting Cables	Connects C200HW Expansion I/O Racks to CPU (CS1) Racks or CS1 Expansion I/O Racks.	Length: 0.3 m	—	CS1W-CN311
		Length: 0.7 m		CS1W-CN711
		Length: 2 m		CS1W-CN221
		Length: 3 m		CS1W-CN321
		Length: 5 m		CS1W-CN521
		Length: 10 m		CS1W-CN131
		Length: 12 m		CS1W-CN131-B2
C200HW to C200HW Expansion I/O Rack Connecting Cables	Connects C200HW Expansion I/O Racks to other C200HW Expansion I/O Racks.	Length: 0.3 m	N, L, CE, U	C200H-CN311
		Length: 0.7 m		C200H-CN711
		Length: 2 m		C200H-CN221
		Length: 5 m	L, CE	C200H-CN521
		Length: 10 m		C200H-CN131

Special Note: For current consumption, refer to *Current Consumption Tables* (the last 6 pages of this ordering guide).

Item	Description	Mountable racks				Bits allocated (CIO 0000 to CIO 0319)	Standards	Part number
		CPU rack	C200H expansion I/O racks	CS1 expansion racks	SYSMAC BUS slave racks			
DC Input Modules 	12 VDC, 64 pt	Yes	Yes	Yes	Yes	64	U, CE	C200H-ID111
	12 to 24 VDC, 8 inputs	Yes	Yes	Yes	Yes	16	U, C, N, L, CE	C200H-ID211
	24 VDC, 16 inputs	Yes	Yes	Yes	Yes	16		C200H-ID212
AC Input Modules 	100 to 120 VAC, 8 inputs	Yes	Yes	Yes	Yes	16	U, C, N, L	C200H-IA121
	100 to 120 VAC, 16 inputs	Yes	Yes	Yes	Yes	16	CE	C200H-IA122
	200 to 240 VAC, 8 inputs	Yes	Yes	Yes	Yes	16	U, C, N, L	C200H-IA221
	200 to 240 VAC, 16 inputs	Yes	Yes	Yes	Yes	16	CE	C200H-IA222
AC/DC Input Modules 	12 to 24 VAC/VDC, 8 inputs	Yes	Yes	Yes	Yes	16	U, C, N, L, CE	C200H-IM211
	24 VAC/VDC, 16 inputs	Yes	Yes	Yes	Yes	16		C200H-IM212
B7A Input Modules 	16 inputs	Yes	Yes	Yes	Yes	16	U, C, CE	C200H-B7A11
	32 inputs (C200H group-2 Module)	Yes	Yes	Yes	No	32	U, C	C200H-B7A12
Interrupt Input Module 	12 to 24 VDC, 8 inputs	Yes	No	No	No	16	U, C, CE	C200HS-INT01
Relay Output Modules 	250 VAC/24 VDC, 2 A, 8 outputs max.	Yes	Yes	Yes	Yes	16	U, C, N, CE	C200H-OC221
	250 VAC/24 VDC, 2 A, 12 outputs max.	Yes	Yes	Yes	Yes	16		C200H-OC222
	250 VAC/24 VDC, 2 A, 16 outputs max.	Yes	Yes	Yes	Yes	16	U, C, N, L, CE	C200H-OC225
	250 VAC/24 VDC, 2 A, 16 outputs max.	Yes	Yes	Yes	Yes	16		C200H-OC226
	250 VAC/24 VDC, 2 A, isolated contacts, 5 outputs max.	Yes	Yes	Yes	Yes	16	U, C, N, L	C200H-OC223
	250 VAC/24 VDC, 2 A, isolated contacts, 8 outputs max.	Yes	Yes	Yes	Yes	16		C200H-OC224

Special Note: For current consumption, refer to *Current Consumption Tables* (the last 6 pages of this ordering guide).

C200H Basic I/O Modules

Item	Description	Mountable racks				Bits allocated (CIO 0000 to CIO 0319)	Standards	Part number
		CPU rack	C200H expansion I/O racks	CS1 expansion racks	SYSMAC BUS slave racks			
Transistor Output Modules 	12 to 48 VDC, 1 A, 8 sinking outputs	Yes	Yes	Yes	Yes	16	U, C, N, L, CE	C200H-OD411
	24 VDC, 2.1 A, 8 sinking outputs	Yes	Yes	Yes	Yes	16		C200H-OD213
	24 VDC, 0.8 A, 8 sourcing outputs, load short-circuit protection.	Yes	Yes	Yes	Yes	16	U, C, N, L	C200H-OD214
	5 to 24 VDC, 0.3 A, 8 sourcing outputs	Yes	Yes	Yes	Yes	16		C200H-OD216
	5 to 24 VDC, 0.3 A, 12 sinking outputs	Yes	Yes	Yes	Yes	16	U, C, N, L, CE	C200H-OD211
	24 VDC, 0.3 A, 12 sourcing outputs	Yes	Yes	Yes	Yes	16		C200H-OD217
	24 VDC, 0.3 A, 16 sinking outputs	Yes	Yes	Yes	Yes	16		C200H-OD212
	24 VDC, 1 A, 16 sourcing outputs, load short-circuit protection.	Yes	Yes	Yes	Yes	16	CE, U	C200H-OD21A
B7A Output Modules 	16 outputs	Yes	Yes	Yes	Yes	16	U, C, CE	C200H-B7A01
	32 outputs (C200H group-2 Module)	Yes	Yes	Yes	No	32	U, C	C200H-B7A02
B7A Mixed I/O Modules 	16 inputs, 16 outputs (C200H group-2 Module)	Yes	Yes	Yes	No	32	U, C	C200H-B7A21
	32 inputs, 32 outputs (C200H group-2 Module)	Yes	Yes	Yes	No	64	U, C	C200H-B7A22
Triac Output Module 	120 VAC, 1.2 A, 8 outputs	Yes	Yes	Yes	Yes	8	CE	C200H-OA122E
	250 VAC, 1.0 A, 8 outputs	Yes	Yes	Yes	Yes	16	CE	C200H-OA221
	250 VAC, 1.2 A, 8 outputs	Yes	Yes	Yes	Yes	16	CE	C200H-OA223
	250 VAC, 0.3 A, 12 outputs	Yes	Yes	Yes	Yes	16	CE, U	C200H-OA222
	250 VAC, 0.5 A, 12 outputs	Yes	Yes	Yes	Yes	16	U, C, N, L	C200H-OA224
Analog Timer Module 	4-point timer	Yes	Yes	Yes	Yes	16	U, C	C200H-TM001
	External variable resistor connector	—						

Special Note: For current consumption, refer to *Current Consumption Tables* (the last 6 pages of this ordering guide).

Note: The C200H-ID001 (no-voltage contacts, 8 inputs, NPN) and C200H-ID002 (no-voltage contacts, 8 inputs, PNP) cannot be used. (As a general reference, see the Non-compatible Models section within this Ordering Guide.)

B7A Transistor I/O Link Modules

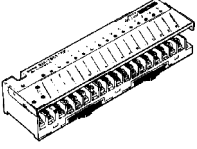
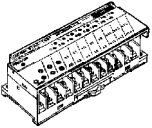
Item/Description						Part number
Appearance	I/O classification	I/O configuration	I/O delay (typical)	Internal I/O common	Error processing (See Note 1.)	
	Input, 16 points	NPN compatible	Normal speed 19.2 ms	- common	—	B7A-T6A1 (See Note 2.)
				+/- common	—	B7A-T6B1 (See Note 2.)
		PNP compatible	High speed 3 ms	+/- common	—	B7A-T6C1
				- common	—	B7A-T6A6 (See Note 2.)
		NPN compatible	High speed 3 ms	+/- common	—	B7A-T6B6 (See Note 2.)
				- common	—	B7A-T6C6
	Output, 16 points	NPN open collector 100 mA/point	Normal speed 19.2 ms	+ common	HOLD	B7A-R6B11
					LOAD OFF	B7A-R6B31
				- common	HOLD	B7A-R6C11
					LOAD OFF	B7A-R6C31
		PNP open collector 100 mA/point	High speed 3 ms	+ common	HOLD	B7A-R6F11
					LOAD OFF	B7A-R6F31
		PNP open collector 500 mA/point (See Note 3.)	High speed 3 ms	+ common	HOLD	B7A-R6G11
					LOAD OFF	B7A-R6G31
		NPN open collector 100 mA/point	High speed 3 ms	- common	HOLD	B7A-R6B16
					LOAD OFF	B7A-R6B36
NPN open collector 500 mA/point (See Note 3.)	High speed 3 ms	- common	HOLD	B7A-R6C16		
			LOAD OFF	B7A-R6C36		
PNP open collector 100 mA/point	High speed 3 ms	- common	HOLD	B7A-R6F16		
			LOAD OFF	B7A-R6F36		
PNP open collector 500 mA/point (See Note 4.)	High speed 3 ms	- common	HOLD	B7A-R6G16		
			LOAD OFF	B7A-R6G36		
	Input, 16 points	NPN compatible	Normal speed 19.2 ms	+/- common	—	B7AS-T6B1
			High speed 3 ms		—	B7AS-T6B6
	Output, 16 points	NPN open collector 100 mA/point	Normal speed 19.2 ms	+/- common	HOLD	B7AS-R6B11
					LOAD OFF	B7AS-R6B31
			High speed 3 ms	+/- common	HOLD	B7AS-R6B16
					LOAD OFF	B7AS-R6B36

- Note: 1. HOLD: The previous output condition will be on hold when an error occurs.
LOAD OFF: All outputs will be OFF when an error occurs.
2. The 16-point B7A-T6A□ and 16-point B7A-T6B□ are different from each other in terminal configuration.
3. N-channel MOSFET open drain output
4. P-channel MOSFET open drain output

C200H Basic I/O Modules

B7A Link Master Adapters for C200H High-density I/O Modules and Group-2 High-density I/O Modules

Item/Description						Part number
Appearance	I/O classification	I/O configuration	I/O delay (typical)	Internal I/O Common	Error processing	
	Input, 16 points	NPN compatible	Normal speed 19.2 ms	NA	—	B7A-T6E3
			High speed 3 ms	NA	—	B7A-T6E8
	Output, 16 points	NPN open collector 50 mA/point	Normal speed 19.2 ms	NA	HOLD	B7A-R6A13
					LOAD OFF	B7A-R6A33
			High speed 3 ms	NA	HOLD	B7A-R6A18
					LOAD OFF	B7A-R6A38
	Input, 32 points	NPN compatible	Normal speed 19.2 ms	NA	—	B7A-T3E3
			High speed 3 ms	NA	—	B7A-T3E8
	Output, 32 points	NPN open collector 50 mA/point	Normal speed 19.2 ms	NA	HOLD	B7A-R3A13
					LOAD OFF	B7A-R3A33
			High speed 3 ms	NA	HOLD	B7A-R3A18
					LOAD OFF	B7A-R3A38

Item 	Description	Mountable racks				Standards	Part number
		CPU Rack	C200H Expansion I/O Racks	CS1 Expansion Racks	SYSMAC BUS Slave Racks		
DC Input Modules	24 VDC, 32 inputs	Yes	Yes	Yes	Yes	U, C, N, L, CE	C200H-ID215
TTL Input Modules	5 VDC, 32 inputs	Yes	Yes	Yes	Yes		C200H-ID501
Transistor Output Modules	24 VDC, 32 sinking outputs	Yes	Yes	Yes	Yes		C200H-OD215
TTL Output Modules	5 VDC, 32 sinking outputs	Yes	Yes	Yes	Yes		C200H-OD501
TTL I/O Modules	5 VDC, 16 inputs, 16 sinking outputs	Yes	Yes	Yes	Yes		C200H-MD501
DC Input/Transistor Output Modules	24 VDC, 16 inputs, 16 sinking outputs	Yes	Yes	Yes	Yes	U, C	C200H-MD215
	12 VDC, 16 inputs, 16 sinking outputs	Yes	Yes	Yes	Yes		C200H-MD115

Connectors for C200H High-density I/O Modules

Item	Connection	Fujitsu parts	Standards	Part number
Applicable Connectors	Solder-type (included with Module)	Socket: FCN-361J024-AU Connector bar: FCN-360C024-J2	—	C500-CE241
	Crimp-type	Socket: FCN-363J024 Connector bar: FCN-360C024-J2 Contacts: FCN-363J-AU		C500-CE242
	Ribbon-crimp	—		C500-CE243

Special Note: For current consumption, refer to *Current Consumption Tables* (the last 6 pages of this ordering guide).

C200H Group-2 High-density I/O Modules



Item	Description	Mountable racks				Bits allocated (CIO 0000 to CIO 0319)	Standards	Part number
		CPU rack	C200H expansion I/O racks	CS1 expansion racks	SYSMAC BUS slave racks			
DC Input Modules 	24 VDC, 32 inputs	Yes	Yes	Yes	No	32	U, C, N, L, CE	C200H-ID216
	24 VDC, 64 inputs	Yes	Yes	Yes	No	64		C200H-ID217
	24 VDC, 32 inputs	Yes	Yes	Yes	No	32	U, C, CE	C200H-ID218
	12 VDC, 64 inputs	Yes	Yes	Yes	No	64	U, C	C200H-ID111
Transistor Output Modules	16 mA/4.5 V, or 100 mA/26.4 V, 32 sinking outputs	Yes	Yes	Yes	No	32	U, C, N, L, CE	C200H-OD218
	16 mA/4.5 V, or 100 mA/26.4 V, 64 sinking outputs	Yes	Yes	Yes	No	64		C200H-OD219
	24 VDC, O.SA, 32 sourcing outputs, load short-circuit protection	Yes	Yes	Yes	No	32	U, C, CE	C200H-OD21B

Connectors for C200H Group-2 High-density I/O Modules

Item	Connection	Fujitsu parts	Standards	Part number
Applicable Connector	Solder-type (included with Module)	Socket: FCN-361J040-AU Connector bar: FCN-360C040-J2	—	C500-CE404
	Crimp-type	Socket: FCN-363J040 Connector bar: FCN-360C040-J2 Contacts: FCN-363J-AU		C500-CE405
	Ribbon-crimp type	FCN-367J040-AU		C500-CE403

CS1 Ordering Guide

CS1 High-density I/O Modules



Item	Description	Mountable racks				Bits allocated (CIO 0000 to CIO 0319)	Standards	Part number
		CPU rack	C200H expansion I/O racks	CS1 expansion racks	SYSMAC BUS slave racks			
DC Input Modules	24 VDC, 96 inputs	Yes	No	Yes	No	96	U, C, N, CE, L	CS1W-ID291
Transistor Output Modules 	12 to 24 VDC, 0.1 A, 96 sinking outputs	Yes	No	Yes	No	96	U, C, N, CE, L	CS1W-OD291
	12 to 24 VDC, 0.1 A, 96 sourcing outputs	Yes	No	Yes	No	96		CS1W-OD292
DC Input/Transistor Output Modules 	24 VDC, 0.1 A, 48 inputs, 48 outputs, sinking inputs/outputs	Yes	No	Yes	No	96 total 48 outputs, 48 inputs	U, C, N, CE, L	CS1W-MD291
	24 VDC, 0.1 A, 48 inputs, 48 outputs, sourcing inputs/outputs	Yes	No	Yes	No	96 total 48 outputs, 48 inputs		CS1W-MD292

Connectors for CS1 High-density I/O Modules

Item	Connection	Description	Part number
Applicable Connectors	Solder-type (included with module)	Socket: FCN-361J056-AU Connector bar: FCN-360C056-J2	CS1W-CE561
	Crimp-type	Socket: FCN-363J056 Connector bar: FCN-360C056-J2 Contacts: FCN-363J-AU	CS1W-CE562
	Ribbon-type	FCN-367J056-AU	CS1W-CE563

High-density I/O Screw Terminal Blocks and Cables

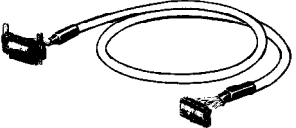
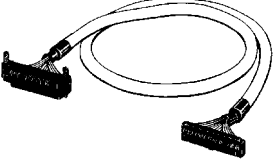
Screw Terminal Blocks and Cables

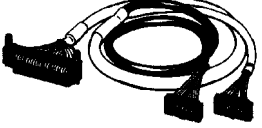
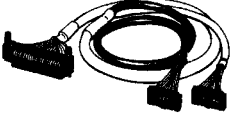
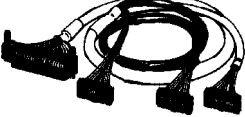
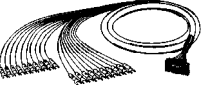
Item/Description			Part number
Appearance	Applicable terminal block	Cable length	
Single Cable for 32-pt I/O Modules 	XW2B-20G5 XW2B-20G4 XW2B-20G5-T XW2B-20G5-D XW2C-20G5-IN16	0.5 m (1.64 ft)	XW2Z-050A
		1 m (3.28 ft)	XW2Z-100A
		1.5 m (4.92 ft)	XW2Z-150A
		2 m (6.56 ft)	XW2Z-200A
		3 m (9.84 ft)	XW2Z-300A
		5 m (16.40 ft)	XW2Z-500A
Single cable for 32- and 64-pt I/O Modules 	XW2B-40G5 XW2B-40G4	0.5 m (1.64 ft)	XW2Z-050B
		1 m (3.28 ft)	XW2Z-100B
		1.5 m (4.92 ft)	XW2Z-150B
		2 m (6.56 ft)	XW2Z-200B
		3 m (9.84 ft)	XW2Z-300B
		5 m (16.40 ft)	XW2Z-500B
Single Cable for CS1W High-density I/O Modules 	XW2B-60G5 XW2B-60G4	1 m (3.28 ft)	XW2Z-100H-1
		2 m (6.56 ft)	XW2Z-200H-1
		3 m (9.84 ft)	XW2Z-300H-1
		5 m (16.40 ft)	XW2Z-500H-1
Bifurcated Cable for 32- and 64-pt I/O Modules 	XW2C-20G5-IN16	1 m (3.28 ft) and 0.75 m (2.46 ft)	XW2Z-100D
		1.5 m (4.92 ft) and 1.25 m (4.10 ft)	XW2Z-150D
		2 m (6.56 ft) and 1.75 m (5.74 ft)	XW2Z-200D
		3 m (9.84 ft) and 2.75 m (9.02 ft)	XW2Z-300D
		5 m (16.40 ft) and 4.75 m (15.58 ft)	XW2Z-500D
Bifurcated Cable for CS1W High-density I/O Modules 	XW2B-40G5 XW2B-20G5	1 m (3.28 ft) and 1 m (3.28 ft)	XW2Z-100H-2
		2 m (6.56 ft) and 2 m (6.56 ft)	XW2Z-200H-2
		3 m (9.84 ft) and 3 m (6.56 ft)	XW2Z-300H-2
		5 m (16.40 ft) and 5 m (16.40 ft)	XW2Z-500H-2
96-pt connector Cable for CS1W I/O Modules (1:3) 	Three XW2B-20G5	1 m (3.28 ft) and 0.75 m (2.45 ft) and 1 m (3.28 ft)	XW2Z-100H-3
		2 m (6.56 ft) and 1.75 m (5.74 ft) and 2 m (6.56 ft)	XW2Z-200H-3
		3 m (9.84 ft) and 2.75 m (9.02 ft) and 3 m (9.84 ft)	XW2Z-300H-3
		5 m (16.40 ft) and 4.75 m (15.58 ft) and 5 m (16.40 ft)	XW2Z-500H-3
Single Cable terminated with crimp hooks (for 8-pt or 16-pt modules) 	XW2B-20G5 XW2B-20G4	1 m (3.28 ft)	XW2Z-100F
		1.5 m (4.92 ft)	XW2Z-150F
		2 m (6.56 ft)	XW2Z-200F
		3 m (9.84 ft)	XW2Z-300F
		5 m (16.40 ft)	XW2Z-500F

High-density I/O Relay Blocks, Bases and Dedicated Cables

G7TC Relay I/O Blocks

Item/Description				Part number
I/O classification	I/O points	Internal I/O circuit common	Rated coil voltage	
Input	16 points	NPN (⊖ common)	24 VDC	G7TC-ID16 DC24V
				G7TC-ID16-5 DC24V (See Note 1.)
		NPN (⊖ common)	110/120 VAC	G7TC-IA16 AC110/120V
			220/240 VAC	G7TC-IA16-5 AC100/110V (See Note 1.)
Output (See Note 2.)	16 points	NPN (⊕ common)	12 VDC	G7TC-OC16 DC12V
			24 VDC	G7TC-OC16 DC24V
		PNP (⊖ common)	24 VDC	G7TC-OC16-1 DC24V
			8 points	NPN (⊕ common)
			24 VDC	G7TC-OC08 DC24V
			PNP (⊖ common)	24 VDC

Note: 1. The "-5" Block is for use with the DRT1-ID16X DeviceNet Remote adapter.
 2. Output relays are rated up to 250 VAC. See *Specifications* (within the *G7TC data sheet*) for specific relay ratings.

P7TF block bases and I/O Relays

Combine I/O Relays and P7TF Block Bases to match your application requirements. Use the table below to configure Relay I/O Blocks.

I/O points	Internal I/O circuit	Part number				
		Block Base	I/O Relay		Solid State Relay	
16 inputs (AC coil)	NPN (- common)	P7TF-IS16 AC110/120V	1 A	G7T-1122S AC110/120 or G7T-1122S AC200/220V	25 mA	G3TA-IAZR02S AC100/240V
16 inputs (DC coil)	NPN (- common)	P7TF-IS16 DC24V	1 A	G7T-1122S DC24V	25 mA	G3TA-DZR02S DC5-24V
16 outputs (DC coil)	NPN (+ common)	P7TF-OS16 DC12V	5 A	G7T-1112S DC12V	2 A	G3TA-ODX02S 12VDC
	NPN (+ common)	P7TF-OS16 DC24V	5 A	G7T-1112S DC24V	2 A	G3TA-ODX02S DC24V or
	PNP (- common)	P7TF-OS16-1 DC24V	5 A	G7T-1112S DC24V	1 A	G3TA-OD201S DC24V
8 outputs (DC coil)	NPN (+ common)	P7TF-OS08 DC12V	5 A	G7T-1112S DC12V	2 A	G3TA-ODX02S 12VDC
	NPN (+ common)	P7TF-OS08 DC24V	5 A	G7T-1112S DC24V	2 A	G3TA-ODX02S DC24V or
	PNP (- common)	P7TF-OS08-1 DC24V	5 A	G7T-1112S DC24V	1 A	G3TA-OD201S DC24V

Accessories (order separately)

Item/Description	Part number
Single I/O socket for SPST and SPDT Relays	P7TF-05
Indicator module for AC (with varistor surge suppression)	P70A
Indicator module for DC (with diode surge suppression)	P70D
Output short circuit protection module	G77-5
Shorting bar	G78-04
Finger protection cover for 16 pt block	G78-E

High-density I/O Relay Blocks, Bases and Dedicated Cables

G70A Relay Terminal Block Bases

Relays not included. Order below.

Item/Description				Part number
Classification	PLC Module	Internal I/O circuit	Rated voltage	
Output	C200H-MD215 (16/16) C200H-OD215 (32) C200H-OD218 (32) C200H-OD219 (64) C200H-OD212 (16)	NPN (+ common)	24 VDC	G70A-ZOC16-3-DC24V
	C200H-OD214 (8 PNP) C200H-OD217 (12 PNP)	PNP (- common)	24 VDC	G70A-ZOC16-4-DC24V
Input	C200H-ID215 (32) C200H-MD215 (16/16) C200H-ID216 (32) C200H-ID217 (64) C200H-ID212 (16)	NPN/PNP	110 VDC max., 240 VAC max. (See Note.)	G70A-ZIM16-5-DC24V

Note: Each relay to be mounted must incorporate a coil that has proper specifications within the maximum rated voltage range.

Relays for Use with G70A Bases

Item	Part number		
Classification	I/O Block Base	PCB Relay	Solid State Relay
Output	NPN: G70A-ZOC16-3-DC24V PNP: G70A-ZOC16-4-DC24V	G2R-1-SND-DC24 G2R-1-SND-DC12	G3R-OA202SZN DC5-24 G3R-ODX02SN DC5-24 G3R-OD201SN DC5-24
Input	G70A-ZIM16-5-DC24V	G2R-1A3-SND-DC24V G2R-13-SND-DC24V	G3R-IAZR1SN AC100-240 G3R-IDZR1SN DC12-24 G3R-IDZR1SN DC5

G70D Relay Output Blocks

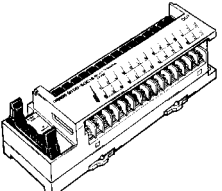
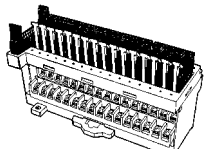
Item/Description					Part number
Appearance	Output points	Rated voltage	Output type	Internal I/O circuit common	
	16 points (SPST-NO x 16) includes relay pulling tool.	24 VDC	Relay outputs	NPN (+ common)	G70D-SOC16 DC24
				PNP (- common)	G70D-SOC16-1 DC24
			Power MOSFET relay outputs	NPN (+ common)	G70D-FOM16
				PNP (- common)	G70D-FOM16-1 DC24
	16 points (SPST-NO x 16)	24 VDC	Relay outputs	NPN (+ common)	G70D-VSOC16
			Power MOSFET relay outputs	NPN (+ common)	G70D-VFOM16





High-density I/O Relay Blocks, Bases and Dedicated Cables

Dedicated Connecting Cables for Omron PLC Modules







The following cables are designed to connect directly to Omron PLC modules and have dedicated connectors for specific models.

Item	Length	Part number
Connecting Cable with three connectors for CS1 Series 96-pt High-density I/O Modules 	1.5 m (4.92 ft) + 1.25 m (4.10 ft) + 1 m (3.28 ft)	G79-150C-125-100
	2 m (6.56 ft) + 1.75 m (5.74 ft) + 1.5 m (4.92 ft)	G79-200C-175-150
	3 m (9.84 ft) + 2.75 m (9.02 ft) + 2.5 m (8.20 ft)	G79-300C-275-250
Connecting Cable with two connectors for C200H 32-pt and 64-pt Group-2 High-density I/O Modules 	1 m (3.28 ft) + 0.75 m (2.46 ft)	G79-O100C-75
	1.5 m (4.92 ft) + 1.25 m (4.10 ft)	G79-O150C-125
	2 m (6.56 ft) + 1.75 m (5.74 ft)	G79-O200C-175
	3 m (9.84 ft) + 2.75 m (9.02 ft)	G79-O300C-275
	5 m (16.40 ft) + 4.75 m (15.58 ft)	G79-O500C-475
Connecting Cable with one connector for C200H 32-pt High-density I/O Modules 	1 m (3.28 ft)	G79-100C
	1.5 m (4.92 ft)	G79-150C
	2 m (6.56 ft)	G79-200C
	3 m (9.84 ft)	G79-300C
	5 m (16.40 ft)	G79-500C

C200H Special I/O Modules

Item	Description	Mountable racks				Standards	Part number
		CPU Rack	C200H Expansion I/O Racks	CS1 Expansion Racks	SYSMAC BUS Slave Racks		
Temperature Control Modules 	Thermocouple input, time-proportioning PID, or ON/OFF transistor output	Yes	Yes	Yes	Yes	U, C	C200H-TC001
	Thermocouple input, time-proportioning PID, or ON/OFF voltage output	Yes	Yes	Yes	Yes	U	C200H-TC002
	Thermocouple input, PID current output	Yes	Yes	Yes	Yes		C200H-TC003
	RTD input, time-proportioning PID, or ON/OFF transistor output	Yes	Yes	Yes	Yes		C200H-TC101
	RTD input, time-proportioning PID, or ON/OFF voltage output	Yes	Yes	Yes	Yes		C200H-TC102
	RTD input, PID current output	Yes	Yes	Yes	Yes		C200H-TC103
Data Setting Console 	Used with Temperature Control Modules. Monitoring, setting, and changing present values, set points, alarm values, PID parameters, bank numbers, etc.	—				U	C200H-DSC01
	Connecting Cable, 2 m	—				—	C200H-CN225
	Connecting Cable, 4 m	—					C200H-CN425
Heat/Cool Temperature Control Modules 	Thermocouple input, time-proportioning PID, or ON/OFF transistor output	Yes	Yes	Yes	Yes	U	C200H-TV001
	Thermocouple input, time-proportioning PID, or ON/OFF voltage output	Yes	Yes	Yes	Yes		C200H-TV002
	Thermocouple input, PID current output	Yes	Yes	Yes	Yes		C200H-TV003
	RTD input, time-proportioning PID, or ON/OFF transistor output	Yes	Yes	Yes	Yes		C200H-TV101
	RTD input, time-proportioning PID, or ON/OFF voltage output	Yes	Yes	Yes	Yes		C200H-TV102
	RTD input, PID current output	Yes	Yes	Yes	Yes		C200H-TV103
Temperature Sensor Modules 	Thermocouple input, K(CA) or J(IC), selectable	Yes	Yes	Yes	Yes	U, C	C200H-TS001
		Yes	Yes	Yes	Yes		C200H-TS002
	RTD input, Pt 100 Ω, conforms to JIS standards	Yes	Yes	Yes	Yes		C200H-TS101
	RTD input, Pt 100 Ω	Yes	Yes	Yes	Yes		C200H-TS102
Voice Module	Voice/Audio input and output for system notification	Yes	Yes	Yes	Yes	U,C	C200H-OV001



Special Note: For current consumption, refer to *Current Consumption Tables* (the last 6 pages of this ordering guide).

Item	Description	Mountable racks				Standards	Part number
		CPU Rack	C200H Expansion I/O Racks	CS1 Expansion Racks	SYSMAC BUS Slave Racks		
Process Control Modules 	Voltage or current input, time-proportioning PID, or ON/OFF transistor output	Yes	Yes	Yes	Yes	U	C200H-PID01
	Voltage or current input, time-proportioning PID, or ON/OFF voltage output	Yes	Yes	Yes	Yes		C200H-PID02
	Voltage or current input, PID current output	Yes	Yes	Yes	Yes		C200H-PID03
Data Setting Console 	Used with PID Control Modules. Monitoring, setting, and changing present values, set points, alarm values, PID parameters, bank numbers, etc.	—				U	C200H-DSC01
	Connecting Cable, 2 m	—				—	C200H-CN225
	Connecting Cable, 4 m	—				—	C200H-CN425
Cam Positioner Module 	48 cam outputs (16 external outputs and 32 internal outputs), Resolver speed: 20 μs (5 kHz)	Yes	Yes	Yes	Yes	U, C	C200H-CP114
Data Setting Console 	Used with Cam Positioner Module. Monitoring, setting, and changing present values, set points, alarm values, PID parameters, bank numbers, etc.	—				U	C200H-DSC01
	Connecting Cable, 2 m	—				—	C200H-CN225
	Connecting Cable, 4 m	—				—	C200H-CN425
ASCII/BASIC Modules 	24-kbyte RAM, 2 RS-232C ports	Yes	Yes	Yes	Yes	N, CE	C200H-ASC02
	200-kbyte RAM, 2 RS-232C ports	Yes	Yes	Yes	Yes	U, C, CE	C200H-ASC11
	200-kbyte RAM, RS-232C port, RS-422/485 port	Yes	Yes	Yes	Yes		C200H-ASC21
	200-kbyte RAM, 3 RS-232C ports (1 terminal only)	Yes	Yes	Yes	Yes		C200H-ASC31
Analog Input Modules (See Note.) 	4 to 20 mA, 1 to 5/0 to 10 V (selectable), 4 inputs, 1/4,000 resolution	Yes	Yes	Yes	Yes	U, C, N, L	C200H-AD001
	4 to 20 mA, 1 to 5/0 to 10 V/-10 to +10 V (selectable); 8 inputs; 1/4,000 resolution	Yes	Yes	Yes	Yes	U, C, N, L, CE	C200H-AD002
	4 to 20 mA, 1 to 5/0 to 10 V/-10 to +10 V (selectable); 8 inputs; 1/4,000 resolution	Yes	Yes	Yes	Yes		C200H-AD003





Note: CS1 Series versions are available; please refer to the CS1 Special I/O subsection within this *Ordering Guide* Section.

Special Note: For current consumption, refer to *Current Consumption Tables* (the last 6 pages of this ordering guide).

C200H Special I/O Modules

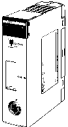
Item	Description	Mountable racks				Standards	Part number	
		CPU Rack	C200H expansion I/O Racks	CS1 Expansion Racks	SYSMAC BUS Slave Racks			
Analog Output Modules * 	4 to 20 mA, 1 to 5 V, 0 to 10 V (selectable); 2 outputs; 1/4,000 resolution	Yes	Yes	Yes	Yes	U, C, N, L	C200H-DA001	
	4 to 20 mA, -10 to +10 V (selectable), 4 outputs; 1/4,000 resolution	Yes	Yes	Yes	Yes	U, C, N, L, CE	C200H-DA002	
	1 to 5 V, -10 to +10 V (selectable), 8 outputs; 1/4,000 resolution	Yes	Yes	Yes	Yes		C200H-DA003	
	4 to 20 mA, 8 outputs; 1/4,000 resolution	Yes	Yes	Yes	Yes		C200H-DA004	
Analog I/O Modules * 	2 inputs (4 to 20 mA, 1 to 5 V, etc.) 2 outputs (4 to 20 mA, 1 to 5 V etc.)	Yes	Yes	Yes	Yes		C200H-MAD01	
High-speed Counter Modules 	One-axis pulse input, counting rate: 50 kcps max.	Yes	Yes	Yes	Yes	U, C, CE	C200H-CT001-V1	
	One-axis pulse input, counting rate: 75 kcps max., line driver compatible	Yes	Yes	Yes	Yes		C200H-CT002	
	Two-axis pulse input, counting rate: 75 kcps max., line driver compatible	Yes	Yes	Yes	Yes		C200H-CT021	
	Solder terminal; 40-pin and a Connector Cover		—				—	C500-CE401
	Solderless terminal; 40-pin and a Connector Cover (Crimp-type)		—					C500-CE402
	Pressure welded terminal; 40-pin		—					C500-CE403
	Solder terminal; 40-pin and a Connector Cover (Horizontal-type)		—					C500-CE404
	Crimp-style terminal; 40-pin and a Connector Cover (Horizontal-type)		—					C500-CE405
Motion Control Modules * 	G-language programmable, two-axis analog outputs	Yes	Yes	Yes	Yes	U, C, CE	C200H-MC221	
	MC Support Software IBM PC/AT or compatible	—				—	CV500-ZN3AT1-E	
	Connecting Cable: 3.3 m	—					CQM1-CIF01	
	Teaching Box	—				U, C, CE	CVM1-PRO01	
	Connection Cable for Teaching Box: 2 m long	—				—	CV500-CN224	
	Memory Pack (with key sheet)	—					CVM1-MP702	
	Terminal Block Conversion Module Simplifies wiring.	—					XW2B-20J6-6	
	Connecting cable for Terminal Block Conversion Module	—					XW2Z-100J-F1	
	Connecting Cable (to servo drive)	—	—	—	—	—	R88A-CPU001-M1	

Special Note: For current consumption, refer to *Current Consumption Tables* (the last 6 pages of this ordering guide). *See CS1 Versions - several pages forward.

Item	Description	Mountable Racks				Standards	Part number
		CPU Rack	C200H Expansion I/O Racks	CS1 Expansion Racks	SYSMAC BUS Slave Racks		
Position Control Modules 	One-axis pulse output, speeds 1 to 500,000 pps, directly connects to servomotor driver, line driver compatible (Z level)	Yes	Yes	Yes	Yes	U, C, CE	C200HW-NC113
	Two-axis pulse output, speeds 1 to 500,000 pps, directly connects to servomotor driver, line driver compatible (Z level)	Yes	Yes	Yes	Yes	U, C, CE	C200HW-NC213
	Four-axis pulse output, speeds 1 to 500,000 pps, directly connects to servomotor driver, line driver compatible (Z level)	Yes	Yes	Yes	Yes		C200HW-NC413
	1-axis cable for C200HW-NC113	—				—	XW2Z-□□□J-A6 (See Note 1.)
	1-axis Servo Relay Module for C200HW-NC113	—					XW2B-20J6-1B
	2-axis cable for C200HW-NC213	—					XW2Z-□□□J-A7 (See Note 1.)
	2-axis Servo Relay Module for C200H-NC213	—					XW2B-40J6-2B
RFID Controller Modules 	Electromagnetic coupling, allows interface to RFID systems	Yes	Yes	Yes	Yes	U, C	C200H-IDS01-V1
	Microwave type, allows interface to RFID systems	Yes	Yes	Yes	Yes	—	C200H-IDS21
DeviceNet Master Module 	DeviceNet Remote I/O Master, 50 nodes max., (without "configurator"); 63 nodes max. (with "configurator").	Yes	Yes	Yes	No	U, C, N, L, CE	C200HW-DRM21-V1 (See Note 2.)
DeviceNet I/O Link Module 	DeviceNet Remote I/O Slave, supports 512 input points. and 512 output points. For details on Slave Modules, refer to the <i>DeviceNet</i> subsection (found a few pages forward within this section).	Yes	Yes	Yes	No	U, C, N, CE	C200HW-DRT21
CompoBus/S Master Modules 	CompoBus/S Remote I/O, 32 slaves/256 bits max. For details on Slave Modules, refer to the <i>DeviceNet</i> subsection (found a few pages forward within this section).	Yes	Yes	Yes	No	U, C, N, L, CE	C200HW-SRM21-V1



Special Note: For current consumption, refer to *Current Consumption Tables* (the last 6 pages of this ordering guide).

Note: 1. Options for □□□ include the following:

- 050 = 0.5 meter length
- 100 = 1.0 meter length
- 200 = 2.0 meter length
- 300 = 3.0 meter length
- 500 = 5.0 meter length

2. The DeviceNet Slaves are allocated up to 2,048 I/O bits (100 words) in the DeviceNet Memory Area.

C200H Special I/O Modules

Item	Description	Mountable Racks				Standards	Part number
		CPU Rack	C200H Expansion I/O Racks	CS1 Expansion Racks	SYSMAC BUS Slave Racks		
PC Link Module 	PC Link, single level: 32 Modules; multilevel: 16 Modules	Yes	Yes	Yes	No	N, L, CE	C200H-LK401 (See Note 1.)
SYSMAC BUS Remote I/O Master Modules 	Wired	Yes	Yes	Yes	No	N, L, CE	C200H-RM201 (See Note 2.)
	Fiber-optic	Yes	Yes	Yes	No	N, L, CE	C200H-RM001-PV1 (See Note 2.)

Special Note: For current consumption, refer to *Current Consumption Tables* (the last 6 pages of this ordering guide).

- Note:
1. PC Link Modules are allocated up to 1,024 bits (64 words) in the Link Area.
 2. Each Slave Rack connected to a Remote I/O Master Module is allocated 10 words in the SYSMAC BUS Area. Each I/O Terminal is allocated 1 word in the I/O Terminal Area.
 3. SYSMAC BUS Remote I/O Slave Devices, Cables, and Accessories can be found in manual W120, Appendix A.

CS1 Motion Control Modules

Item	Description	Mountable racks				Standards	Part number
		CPU Rack	C200HW Expansion Racks	CS1 Expansion Racks	SYSMAC BUS Slave Racks		
Motion Control Modules	CS1W Analog Motion Module, 2-axis	Yes	No	Yes	No	U, C, N, CE, L	CS1W-MC221
	CS1W Analog Motion Module, 4-axis						CS1W-MC421
Configuration Software	CX-Motion Configuration Software for MC Type Modules					—	WS02-MCTC1-E

Peripheral Devices (for Motion Control Modules)

Item/Description		Part number		
Teaching Box		CVM1PRO01-E		
R _{ON} Cassette		CVM1-MP702		
Terminal Block for 2 Axes		XW2B-20J6-6		
Terminal Block for 4 Axes		XW2B-40J6-7		
Terminal Block Cable		XW2Z-100J-F1		
Servo Drive Cables	H-Series	Cable for 1 axis	1 m	R88A-CPH001M1
			2 m	R88A-CPH002M1
		Cable for 2 axes	1 m	R88A-CPH001M2
			2 m	R88A-CPH002M2
	M-Series	Cable for 1	1 m	R88A-CPM001M1
			2 m	R88A-CPM002M1
		Cable for 2 axes	1 m	R88A-CPM001M2
			2 m	R88A-CPM002M2
	U-Series up to 750 W	Cable for 1 axes	1 m	R88A-CPU001M1
			2 m	R88A-CPU002M1
		Cable for 2 axes	1 m	R88A-CPU001M2
			2 m	R88A-CPU002M2
	U-Series from 1 to 5 kW	Cable for 1 axis	1 m	R88A-CPB001M1
			2 m	R88A-CPB002M1
Cable for 2 axes		1 m	R88A-CPB001M2	
		2 m	R88A-CPB002M2	
Personal Computer Cables for CX-Motion Software (See Note.)	Peripheral port	0.1 m	CS1W-CN118	
		2 m	CS1W-CN226	
		6 m	CS1W-CN626	
	RS-232C port	2 m	XW2Z-200S-V	
		5 m	XW2Z-500S-V	

Note: To connect to a CS1 Series CPU Module.

CS1 Special I/O Modules

CS1 Analog Modules

Item	Description	Mountable racks				Standards	Part number
		CPU Rack	C200HW Expansion Racks	CS1 Expansion Racks	SYSMAC BUS Slave Racks		
Analog Input Modules	Module, analog IN, 4-channel, CS1	Yes	No	Yes	No	U, C, N, CE, L	CS1W-AD041
	Module, analog IN, 8-channel, CS1						CS1W-AD081
Analog Output Modules	Module, analog OUT, 8-channel (V), CS1						CS1W-DA041
	Module, analog OUT, 8-channel (A), CS1						CS1W-DA08C
Analog I/O Modules	Module, CS1 mixed analog 4 IN, 4 OUT					CS1W-MAD44	

CS1/C200H Non-compatible Modules

Modules Not Compatible with CS1 Controllers or Systems

The modules listed in the non-compatible part number column cannot be used anywhere within a CS1 System, on a CPU Rack or on CS1/C200HW Expansion Racks. Please contact your Omron Sales Representative for assistance when upgrading existing systems to CS1 systems (i.e., changing from a system with these non-compatible modules).

Note: Many options are available in addition to the suggested replacement module listed here (last column).

Item	Description	Mountable Racks				Part numbers of modules not compatible with CS1 controllers or systems	Suggested replacement part number (See Note.)
		CPU Rack	C200HW Expansion Racks	CS1 Expansion Racks	SYSMAC BUS Slave Racks		
Input Module	8-pt Input, No-volt, NPN	No	No	No	No	C200H-ID001	C200H-ID211
	8-pt Input, No-volt, PNP					C200H-ID002	C200H-ID211
Network Module	HostLink RS-232 Modules	No	No	No	No	C200H-LK201(-V1)	CS1W-SCU21
	HostLink RS-422 Modules					C200H-LK202(-V1)	CS1W-SCU21 CS1W-SCB41
	SYSMAC Link Module, fiber-optic					C200H-SLK11	CS1W-CLK11
	SYSMAC Link Module, wire					C200H-SLK21(-V1)	CS1W-CLK21
	SYSMAC Link Module, fiber-optic					C200HS-SLK12	CS1W-CLK11
	SYSMAC Link Module, wire					C200HS-SLK22	CS1W-CLK21 CS1W-CLK11
	SYSMAC Net Module					C200HS-SNT32	CS1W-CLK21 CS1W-CLK11
	Controller Link Module					C200HW-CLK21	CS1W-CLK21 CS1W-CLK11
	PC Card module					C200HW-PCU01-E	Compact Flash within CS1 CPU
	PC Card with ethernet support					C200HW-PCS01-E(V1)	CS1W-ETN01
	SYSMAC Link Module, fiber-optic					C200HW-SLK13	CS1W-CLK11
	SYSMAC Link Module, fiber-optic, 3K data					C200HW-SLK14	CS1W-CLK11
	SYSMAC Link Coax Module					C200HW-SLK23	CS1W-CLK21
	SYSMAC Link Coax Module, 3K data					C200HW-SLK24	CS1W-CLK21

CS1 Communications and Network Modules

Communications and Network Modules

Item 	Description	Mountable racks				Words allocated (CIO 1500 to CIO 1899)	Standards	Part number
		CPU Rack	C200H Expansion I/O Racks	CS1 Expansion Racks	SYSMAC BUS Slave Racks			
Controller Link Modules	Wired	Yes	No	Yes	No	25 words	U, C, N, CE, L	CS1W-CLK21
	Fiber-optic	Yes	No	Yes	No	25 words		CS1W-CLK11
Serial Communications Module	Two RS-232C Ports	Yes	No	Yes	No	25 words		CS1W-SCU21
Ethernet Module	FINS communications, TCP/IP and UDP/IP Socket Services, FTP server, email notification	Yes	No	Yes	No	25 words		CS1W-ETN01

Special Note: For current consumption, refer to *Current Consumption Tables* (the last 6 pages of this ordering guide).

Fiber-optic Cables and Connectors for Controller Link

Item/Description	Comments	Part number
Connector, half lock	—	S3200-COCF2511
Connector, full lock	Two required for each module or NSB.	S3200-COCF2011
Fiber-optic cable, duplex, zipcord, 50M	Use for short runs; do not pull through conduit. Orange color.	FCS-HCR-CO-501
Fiber-optic cable, duplex, jacketed, 50M	Use for pulling through conduit. Black jacket with stress members. Custom jackets for burial, and special environments are available for custom orders.	FCS-HCR-LB-501
Fiber-optic cable, duplex, jacketed, 100 M		FCS-HCR-LB-102
Fiber-optic cable, duplex, jacketed, 500 M		FCS-HCR-LB-501
Fiber-optic cable, duplex, jacketed, 1000 M		FCS-HCR-LB-103

- Note:
1. Connectors and cables must be purchased separately from the modules and NSB's.
 2. Cable is bulk, non-terminated.
 3. Termination kit required to attach connectors to cable.
 4. Cable testing and termination assistance is available.
 5. Special pre-terminated cables are available by special order.

Item/Description				Part number
Group	Module/Terminal	I/O points	Standards	
Basic Terminals and Modules	Remote Transistor Input Terminals	8 inputs	U, C	DRT1-ID08-DC24-1
		16 inputs		DRT1-ID16-DC24
	Remote Transistor Output Terminals	8 outputs		DRT1-OD08
		16 outputs		DRT1-OD16
	Environmentally Resistant Transistor I/O Terminals	8 inputs	CE	DRT1-ID08C
		8 outputs		DRT1-OD08C-DC24
		8 inputs and 8 outputs		DRT1-MD16C
		16 point input, NPN		DRT1-HD16C
		16 point output, PNP		DRT1-HD16C-1
		16 point input, NPN		DRT1-WD16C
		16 point output, PNP		DRT1-WD16C-1
	8 inputs, 8 outputs, PNP	DRT1-MD16C-1		
	Basic Terminals and Modules	Remote Adapters	16 inputs	U, C
16 outputs			DRT1-OD16X-DC24	
Sensor Terminals		16 inputs	—	DRT1-HD16S
		8 inputs and 8 outputs		DRT1-ND16S
Temperature Input Terminals		4 inputs (4 words)		DRT1-TS04T
				DRT1-TS04P
CQM1 I/O Link Module		16 inputs and 16 outputs	U, C, CE	CQM1-DRT21
Analog Terminals	Analog Input Terminals	2 or 4 inputs (2 or 4 words) (voltage or current)	CE	DRT1-AD04
		4 inputs (4 words) (voltage or current)	—	DRT1-AD04H
	Analog Output Terminals	2 outputs (2 words)	CE	DRT1-DA02
Special Modules and Terminals	C200H I/O Link Module	512 inputs (32 words) max. 512 outputs (32 words) max.	U, C, N, CE	C200HW-DRT21
	RS-232C Module	16 inputs (1 word)	U, C, CE	DRT1-232C2
	B7AC Interface Terminal	30 points (10 words/B7AC)	CE	DRT1-B7AC
Optional Parts	T-branch Taps	1-branch Tap	—	DCN1-1
		1-branch Tap with Connectors		DCN1-1C
		3-branch Tap		DCN1-3
		3-branch Tap with Connectors		DCN1-3C
	Special Cables	Thin	DCA1-5C10	
		Thick	DCA2-5C10	
	Terminal Block with Terminating Resistance	—	DRS1-T	

DeviceNet Multiple I/O Terminal Modules

DeviceNet Communications Module

Item/Description				Part number
Number of slaves	Number of slave I/O points	Rated voltage	Standards	DRT1-COM
8	1,024 max., input and output combined	24 VDC	U, C, CE	

Digital I/O Modules

Item	Classification	Internal I/O circuit common	I/O points	I/O connections	I/O specifications	Standards	Part number	
Terminal Block-type Digital I/O Modules	Digital input	NPN (+ common)	16	M3 terminal block	DC/Tr	U, C, CE	GT1-ID16	
		PNP (- common)					GT1-ID16-1	
	Digital output	NPN (- common)			0.5 A DC/Tr		GT1-OD16	
		PNP (+ common)			GT1-OD16-1			
Connector-type Digital I/O Modules	Digital input	NPN (+ common)		Molex connectors	DC/Tr	0.5 A DC/Tr	U, C, CE	GT1-ID16MX
		PNP (- common)						GT1-ID16MX-1
	Digital output	NPN (- common)			GT1-OD16MX			
		PNP (+ common)			GT1-OD16MX-1			
	Digital input	NPN (+ common)	Fujitsu connectors	DC/Tr	CE	0.5 A DC/Tr	GT1-ID16ML	
		PNP (- common)					GT1-ID16ML-1	
	Digital output	NPN (- common)	GT1-OD16ML					
		PNP (+ common)	GT1-OD16ML-1					
Digital input	NPN (+ common)	25-pin D-sub connectors	DC/Tr	0.5 A DC/Tr	U, C, CE	GT1-ID16DS		
						PNP (- common)	GT1-ID16DS-1	
	Digital output		NPN (- common)			GT1-OD16DS		
			PNP (+ common)			GT1-OD16DS-1		
Multi-point Connector-type Digital I/O Modules	Digital input	NPN (+ common)	32	Fujitsu connectors	DC/Tr	U, C, CE	GT1-ID32ML	
		PNP (- common)					GT1-ID32ML-1	
	Digital output	NPN (- common)		GT1-OD32ML				
		PNP (+ common)		GT1-OD32ML-1				

Relay Output Modules

Item	I/O points	I/O connection method	Description	Standards	Part number
Relay Output	16 points	M3 terminal block	2 A, AC, DC, SPST-NO	CE	GT1-ROS16
	8 points		5 A, AC, DC, SPST-NO	U, L, CE	GT1-ROP08

Analog I/O Modules

Item	I/O	I/O connections	Description	Standards	Part number
Analog Input Module	8 inputs	Connectors	4 to 20 mA, 0 to 20 mA, 0 to 5 V, 1 to 5 V, 0 to 10 V, -10 to 10 V	U, C, CE	GT1-AD08MX
	4 inputs	Terminal block			GT1-AD04
Analog Input Module	8 inputs	Connectors	4 to 20 mA, 0 to 20 mA, 0 to 5 V, 1 to 5 V, 0 to 10 V, -10 to 10 V	U, L, CE	GT1-AD08MX
	4 inputs	Terminal block			GT1-AD04
Analog Output Module	4 outputs	Connector	0 to 5 V, 1 to 5 V, 0 to 10 V, -10 to 10 V	U, C, CE	GT1-DA04MX
		Terminal block	0 to 5 V, 1 to 5 V, 0 to 10 V, -10 to 10 V, 4 to 20 mA		GT1-DA04

Counter Module

Item	External I/O	I/O connection method	Operating mode	Standards	Part number
Counter Module	1 input, 2 outputs	Terminal block (M3 terminals)	Linear counter	CE	GT1-CT01





Item (Slave type)	Description	Standards	Part number (See Note.)
Remote I/O Transistor Terminals	4 inputs (NPN)	U, C, CE	SRT1-ID04
	4 inputs (PNP)		SRT1-ID04-1
	8 inputs (NPN)		SRT1-ID08
	8 inputs (PNP)		SRT1-ID08-1
	16 inputs (NPN)		SRT1-ID16
	16 inputs (PNP)		SRT1-ID16-1
	4 outputs (NPN)		SRT1-OD04
	4 outputs (PNP)		SRT1-OD04-1
	8 outputs (NPN)		SRT1-OD08
	8 outputs (PNP)		SRT1-OD08-1
	16 outputs (NPN)		SRT1-OD16
	16 outputs (PNP)		SRT1-OD16-1
Remote I/O Relay Output Blocks	8 relay outputs	U, C, CE	SRT1-ROC08
			SRT1-ROC16
	8 MOSFET outputs	U, C, CE	SRT1-ROF08
			SRT1-ROF16
Sensor Amp Terminals	4 inputs (1 word x 4 terminals)	—	SRT1-TID04S
	4 inputs (4 words x 1 terminal)		SRT1-TKD04S
Expansion Sensor Amp Terminals	4 inputs (1 word x 4 terminals)		SRT1-XKD04S
	4 inputs (4 words x 1 terminal)		SRT1-XID04S
Sensor Remote Terminal Blocks	8 inputs	SRT1-ID08S	
	8 outputs	SRT1-OD08S	
	4 inputs and 4 outputs	SRT1-ND08S	

Note: SRT1 and SRT2 can be used together in the same system at high speed setting on the SRT2's.

NEW! 500 M Capable! Long Distance CompoBus/S Slave Modules

Item (Slave type)	Description	Standards	Part number
Transistor Remote I/O Terminal Blocks	4 transistor inputs (NPN)	U, C, CE	SRT2-ID04
	4 transistor inputs (PNP)		SRT2-ID04-1
	8 transistor inputs (NPN)		SRT2-ID08
	8 transistor inputs (PNP)		SRT2-ID08-1
	16 transistor inputs (NPN)		SRT2-ID16
	16 transistor inputs (PNP)		SRT2-ID16-1
	4 transistor outputs (NPN)		SRT2-OD04
	4 transistor outputs (PNP)		SRT2-OD04-1
	8 transistor outputs (NPN)		SRT2-OD08
	8 transistor outputs (PNP)		SRT2-OD08-1
	16 transistor outputs (NPN)		SRT2-OD16
	16 transistor outputs (PNP)		SRT2-OD16-1
Remote I/O Transistor Terminals with independent common terminals for each point	16 inputs (NPN, + common)	CE	SRT2-ID16T
	16 inputs (PNP, - common)		SRT2-ID16T-1
	16 inputs/outputs (NPN, - common)		SRT2-MD16T
	16 inputs/outputs (PNP, + common)		SRT2-MD16T-1
	16 outputs (NPN, - common)		SRT2-OD16T
	16 outputs (PNP, + common)		SRT2-OD16T-1
Remote Relay Terminals	8 relay outputs	U, C, CE	SRT2-ROC08
	16 relay outputs		SRT2-ROC16
	8 power MOSFET outputs		SRT2-ROF08
	16 power MOSFET outputs		SRT2-ROF16
Connector-Style Remote Terminal Blocks	8 transistor inputs (NPN)	U, C, CE	SRT2-VID085
	8 transistor inputs (PNP)		SRT2-VID085-1
	8 transistor outputs (NPN)		SRT2-VOD085
	8 transistor outputs (PNP)		SRT2-VOD085-1
	16 transistor inputs (NPN)		SRT2-VID16ML
	16 transistor inputs (PNP)		SRT2-VID16ML-1
	16 transistor outputs (NPN)		SRT2-VOD16ML
	16 transistor outputs (PNP)		SRT2-VODML-1
Analog Input	1 to 4 (selectable) analog inputs	U, C, CE	SRT2-AD04
Analog Output	1 or 2 (selectable) analog outputs	U, C, CE	SRT2-DA02

Module Accessories

Item	Description	Standards	Part number
 I/O Module Cover	Cover for 10-pin terminal block	—	C200H-COV11
 Terminal Block Covers	Short protection for 10-pin terminal block (package of 10 covers); 8 pts	—	C200H-COV02
	Short protection for 19-pin terminal block (package of 10 covers); 12 pts		C200H-COV03
 C200H Module Connector Cover	Protective cover for unused I/O Connecting Cable connectors	—	C500-COV02
 CS1 Special I/O Module Connector Cover	Protective cover for unused I/O Connecting Cable connectors		CV500-COV01
 Relay	24 VDC, for C200H-OC221/OC222/OC223/OC224/OC225	—	G6B-1174P-FD-US

Mounting Rails and Accessories

Item	Description	Standards	Part number
 Programming Console Mounting Bracket	Used to attach C200H-PRO27-E Hand-held Programming Console to a panel.	—	C200H-ATT01
 DIN-rail Mounting Bracket	1 set (2 included)	N, L, CE	C200H-DIN01
 DIN Rails	Length: 50 cm; height: 7.3 cm		PFP-50N
	Length: 1 m; height: 7.3 cm		PFP-100N
	Length: 50 cm; height: 16 mm		PFP-100N2
 End Plate	---		PFP-M
 Spacer	---	PFP-S	
 C200HW Expansion I/O Rack Insulation Plates	Electrically insulate C200HW Expansion I/O Racks from the control panel to increase noise-resistance.	For 3-slot Rack	C200HW-ATT32
		For 5-slot Rack	C200HW-ATT52
		For 8-slot Rack	C200HW-ATT82
		For 10-slot Rack	C200HW-ATTA2

Current Consumption Tables

The amount of current/power that can be supplied to the Modules mounted in a Rack is limited by the capacity of the Rack's Power Supply.

Consider the Current/Power Consumption When Designing the System

- The total current consumption of the Modules must not exceed the maximum current for each voltage group.
- The total power consumption must not exceed the maximum for the Power Supply

CPU Racks and Expansion Racks

The following table shows the maximum currents and power that can be supplied by Power Supplies on CPU Racks and Expansion Racks (both CS1 Expansion Racks and C200HW Expansion I/O Racks).

Note: 1. When calculating current/power consumption in a CPU Rack, be sure to include the power required by the CPU Rack and CPU themselves.
2. Likewise, be sure to include the power required by the Rack itself when calculating the current/power consumption in an Expansion Rack.

Power Supply	Max. Current Capacity			Max. Total Power Consumption
	5-V group	26-V group	24-V group	
C200HW-PA204	4.6 A	0.6 A	None	30 W
C200HW-PA204S	4.6 A	0.6 A	0.8 A	30 W
C200HW-PA204R	4.6 A	0.6 A	None	30 W
C200HW-PD204	4.6 A	0.6 A	None	30 W
C200HW-PA209R	9 A	1.3 A	None	45 W

SYSMAC BUS Slave Racks

The following table shows the maximum current and power supplied by Power Supplies in SYSMAC BUS Slave Racks.

Note: Be sure to include the power required by the Rack itself when calculating current/power consumption.

Slave Module	Max. Current Capacity			Max. Total Power Consumption
	5-V group	26-V group	24-V group	
C200H-RT201 (Wired)	2.7 A	0.6 A	0.3 A	28 W
C200H-RT202 (Wired)	2.7 A	0.6 A	None	23 W
C200H-RT001-P (Fiber-optic)	2.7 A	0.6 A	0.3 A	28 W
C200H-RT002-P (Fiber-optic)	2.7 A	0.6 A	None	23 W

Note: The current consumed by each voltage group must not exceed the maximum current shown in the table above.

Be Sure Both Condition 1 and Condition 2 (Listed Below) Are Met

Condition 1: Maximum Current Supply

1. Current required at 5 VDC by all Modules (A) \leq Max. Current shown in table
2. Current required at 26 VDC by all Modules (B) \leq Max. Current shown in table
3. Current required at 24 VDC by all Modules (C) \leq Max. Current shown in table

Condition 2: Maximum Total Current Supply

1. $A \times 5 \text{ VDC} + B \times 26 \text{ VDC} + C \times 24 \text{ VDC} \leq$ Max. Power shown in table

Example Calculations

Example 1

In this example, the following Modules are mounted to a CPU Rack with a C200HW-PA204S Power Supply.

Item	Part number	Quantity	5-VDC	26-VDC	24-VDC
CPU Rack (8 slots)	CS1W-BC083	1	0.11 A	—	—
CPU	CS1H-CPU67-E	1	1.10 A	—	—
Input Modules	C200H-ID216	2	0.10 A	—	—
	CS1W-ID291	2	0.20 A	—	—
Output Modules	C200H-OC221	2	0.01 A	0.075 A	—
Special I/O Modules	C200H-NC213	1	0.30 A	—	—
CS1 CPU Bus Module	CS1W-CLK21	1	0.40 A	—	—
Service Power Supply (24 VDC)		0.3 A used	—	—	0.3 A
Total current/power consumption 13.15 + 3.9 + 7.2 = 24.25 (≤30 W)			2.63 A (≤4.6) x 5 V = 13.15W	0.15 A (≤0.6A) x 26 V = 3.9 W	0.3 A (≤0.8A) x 24 V = 7.2 W

Current Consumption Tables

5 VDC Voltage Group — CPUs, Communication Boards, and Racks

Item	Consumption	Part number
CPU Modules (These values include current consumption by a Programming Console or CX-Programmer.)	1.10 A	CS1H-CPU67-E(V□)
	1.10 A	CS1H-CPU66-E(V□)
	1.10 A	CS1H-CPU65-E(V□)
	1.10 A	CS1H-CPU64-E(V□)
	1.10 A	CS1H-CPU63-E(V□)
	0.95 A	CS1G-CPU45-E(V□)
	0.95 A	CS1G-CPU44-E(V□)
	0.95 A	CS1G-CPU43-E(V□)
	0.95 A	CS1G-CPU42-E(V□)
Communication Boards	0.28 A (See Note.)	CS1W-SCB21
	0.36 A (See Note.)	CS1W-SCB41
CPU Racks	0.11 A	CS1W-BC023
	0.11 A	CS1W-BC033
	0.11 A	CS1W-BC053
	0.11 A	CS1W-BC083
	0.11 A	CS1W-BC103
CS1 Racks	0.23 A	CS1W-BI023
	0.23 A	CS1W-BI033
	0.23 A	CS1W-BI053
	0.23 A	CS1W-BI083
	0.23 A	CS1W-BI103
C200H/HW Expansion I/O Racks	0.15 A	C200HW-BI031
	0.15 A	C200HW-BI051
	0.15 A	C200HW-BI081
	0.15 A	C200HW-BI101

Note: Add 0.15 A per port when the NT-AL001-E is connected.

5 VDC Voltage Group — Basic I/O Modules

Item	Description	Consumption (A)	Part number	
C200H Input modules	DC Input modules	0.01	C200H-ID211	
		0.01	C200H-ID212	
	AC Input Modules	0.01	C200H-IA121	
		0.01	C200H-IA122	
		0.01	C200H-IA122	
		0.01	C200H-IA221	
		0.01	C200H-IA222	
		0.01	C200H-IA222V	
	AC/DC Input Modules	0.01	C200H-IM211	
		0.01	C200H-IM212	
	B7A Interface Modules	0.10	C200H-B7AI1	
		0.10	C200H-B7AI2	
	Interrupt Input Module	0.02	C200HS-INT01	
C200H Group-2 High-density Input Modules	DC Input Modules	0.10	C200H-ID216	
		0.12	C200H-ID217	
		0.10	C200H-ID218	
		0.12	C200H-ID219	
		0.12	C200H-ID111	
CS1 High-Density Input Modules	DC Input Modules	0.20	CS1W-ID291	
C200H Output Modules	Relay Output Modules	0.01	C200H-OC221	
		0.01	C200H-OC222	
		0.008	C200H-OC222	
		0.05	C200H-OC225	
		0.03	C200H-OC226	
		0.01	C200H-OC223	
		0.01	C200H-OC224	
		0.01	C200H-OC224	
		Transistor Output Modules	0.14	C200H-OD411
			0.14	C200H-OD213
	0.14		C200H-OD214	
	0.01		C200H-OD216	
	0.16		C200H-OD211	
	0.01		C200H-OD217	
	0.18		C200H-OD212	
	0.16		C200H-OD21A	
	B7A Interface Modules	0.10	C200H-B7A01	
		0.10	C200H-B7A02	
	Triac Output Modules	0.18	C200H-OA122E	
		0.18	C200H-OA223	
		0.20	C200H-OA222	
0.27		C200H-OA224		
C200H Group-2 High-density Output Modules	Transistor Output Modules	0.18	C200H-OD218	
		0.27	C200H-OD219	
CS1 High-Density Output Modules	Transistor Output Modules	0.48	CS1W-OD291	
		0.48	CS1W-OD292	
CS1 High-Density I/O Modules	DC Input/Transistor Output Modules	0.35	CS1W-MD291	
		0.35	CS1W-MD292	
C200H I/O Modules	B7A Interface Modules	0.10	C200H-B7A21	
		0.10	C200H-B7A22	
	Analog Timer Module	0.06	C200H-TM001	

Current Consumption Tables

5 VDC Voltage Group — High-density I/O Modules (Special I/O Modules)

Item	Description	Consumption (A)	Part number
C200H High-density I/O Modules (Special I/O Modules)	DC Input Module	0.13	C200H-ID215
	TTL Input Module	0.13	C200H-ID501
	Transistor Output Module	0.22	C200H-OD215
	TTL Output Module	0.22	C200H-OD501
	TTL I/O Module	0.18	C200H-MD501
	DC Input/Transistor Output Module	0.18	C200H-MD215
		0.18	C200H-MD115

5 VDC Voltage Group — Special I/O Modules

Item	Description	Consumption (A)	Part number
C200H Special I/O Modules	Temperature Control Modules	0.33	C200H-TC001
		0.33	C200H-TC002
		0.33	C200H-TC003
		0.33	C200H-TC101
		0.33	C200H-TC102
		0.33	C200H-TC103
	Heat/Cool Temperature Control Modules	0.33	C200H-TV001
		0.33	C200H-TV002
		0.33	C200H-TV003
		0.33	C200H-TV101
		0.33	C200H-TV102
		0.33	C200H-TV103
	Temperature Sensor Modules	0.45	C200H-TS001
		0.45	C200H-TS002
		0.45	C200H-TS101
		0.45	C200H-TS102
	Process Control Modules	0.33	C200H-PID01
		0.33	C200H-PID02
		0.33	C200H-PID03
	Cam Positioner Module	0.30	C200H-CP114
	ASCII Modules	0.20	C200H-ASC02
		0.25	C200H-ASC11
		0.30	C200H-ASC21
		0.30	C200H-ASC31
	Analog Input Modules	0.55	C200H-AD001
		0.45	C200H-AD002
		0.10	C200H-AD003
	Analog Output Modules	0.65	C200H-DA001
		0.60	C200H-DA002
		0.10	C200H-DA003
		0.10	C200H-DA004
	Analog I/O Modules	0.10	C200H-MAD01
	High-speed Counter Modules	0.30	C200H-CT001-V1
		0.30	C200H-CT002
		0.45	C200H-CT021
	Motion Control Module	0.65 (0.85 for Teaching Box)	C200H-MC221
	Position Control Modules	0.50	C200H-NC211
		0.15	C200H-NC111
		0.15	C200H-NC112
		0.30	C200HW-NC113
0.30		C200HW-NC213	
0.50		C200HW-NC413	
Voice Module	0.30	C200HW-OV001	

(This table continues on the next page.)

Current Consumption Tables

5 VDC Voltage Group — Special I/O Modules (continued)

Item	Description	Consumption (A)	Part number
C200H Special I/O Modules	RFID Controller Modules	0.25	C200H-IDS01-V1
		0.25	C200H-IDS21
	Fuzzy Logic Module	0.30	C200H-FZ001
	DeviceNet Master Module	0.25	C200HW-DRM21-V1
	DeviceNet I/O Link Module	0.25	C200HW-DRT21
	CompoBus/S Master Module	0.15	C200HW-SRM21
	PC Link Module	0.35	C200H-LK401
	SYSMAC BUS Remote I/O Slave Modules	0.20	C200H-RM201
0.20		C200H-RM001-PV1	

CS1 CPU Bus Modules

Item	Description	Consumption (A)	Part number
CS1 CPU Bus Modules	Controller Link Modules	0.35	CS1W-CLK21
		0.50	CS1W-CLK11
	Serial Communications Module	0.30 (See Note.)	CS1W-SCU21
	Ethernet Module	0.40	CS1W-ETN01

Note: Add 0.15 A per port when the NT-AL001-E is connected.

26 VDC Modules

Item	Description	Consumption (A)	Part number
C200H Output Modules	Relay Output Modules	0.075 for 8 points ON at the same time	C200H-OC221
			C200H-OC222
			C200H-OC223
			C200H-OC224
			C200H-OC225
	Relay Output Modules	0.09 for 8 points ON at the same time	C200H-OC222V
			C200H-OC226
			C200H-OC224V
			C200H-OC227
Transistor Output Modules	0.075 for 8 points ON at the same time	C200H-OD216	
		C200H-OD217	
C200H Special I/O Modules	Analog Input Module	0.10	C200H-AD003
	Analog Output Modules	0.20	C200H-DA003
		0.25	C200H-DA004
	Analog Mixed I/O Module	0.20	C200H-MAD01
	RFID Controller Modules	0.12	C200H-IDS01-V1
0.12		C200H-IDS21	
CS1 Special I/O Modules	Analog Mixed I/O Module	0.20	CS1W-MAD44
	Analog Input Modules	0.13 A at 5 VDC 0.1 A at 26 VDC	CS1W-AD041
		0.13 A at 5 VDC 0.1 A at 26 VDC	CS1W-AD081
	Analog Output Modules	0.13 A at 5 VDC 0.18 A at 26 VDC	CS1W-DA041
		0.13 A at 5 VDC 0.18 A at 26 VDC	CS1W-DA08V
		0.13 A at 26 VDC 0.25 A at 26 VDC	CS1W-DA08C
	Motion Control Modules	0.6 A (add 0.2 A with Teach Box)	CS1W-MC221
		0.7 A (add 0.3 A with Teach Box)	CS1W-MC421

Данный компонент на территории Российской Федерации

Вы можете приобрести в компании MosChip.

Для оперативного оформления запроса Вам необходимо перейти по данной ссылке:

<http://moschip.ru/get-element>

Вы можете разместить у нас заказ для любого Вашего проекта, будь то серийное производство или разработка единичного прибора.

В нашем ассортименте представлены ведущие мировые производители активных и пассивных электронных компонентов.

Нашей специализацией является поставка электронной компонентной базы двойного назначения, продукции таких производителей как XILINX, Intel (ex.ALTERA), Vicor, Microchip, Texas Instruments, Analog Devices, Mini-Circuits, Amphenol, Glenair.

Сотрудничество с глобальными дистрибьюторами электронных компонентов, предоставляет возможность заказывать и получать с международных складов практически любой перечень компонентов в оптимальные для Вас сроки.

На всех этапах разработки и производства наши партнеры могут получить квалифицированную поддержку опытных инженеров.

Система менеджмента качества компании отвечает требованиям в соответствии с ГОСТ Р ИСО 9001, ГОСТ РВ 0015-002 и ЭС РД 009

Офис по работе с юридическими лицами:

105318, г.Москва, ул.Щербаковская д.3, офис 1107, 1118, ДЦ «Щербаковский»

Телефон: +7 495 668-12-70 (многоканальный)

Факс: +7 495 668-12-70 (доб.304)

E-mail: info@moschip.ru

Skype отдела продаж:

moschip.ru

moschip.ru_4

moschip.ru_6

moschip.ru_9