

## PRODUCT PERFORMANCE STANDARDS

OMRON devices that comply with EC Directives also conform to the related EMC standards so that they can be more easily built into other devices or the overall machine. The actual products have been checked for conformity to EMC standards (see the following note). Whether the products conform to the standards in the system used by the customer, however, must be confirmed by the customer.

EMC-related performance of the OMRON devices that comply with EC Directives will vary depending on the configuration, wiring, and other conditions of the equipment or control panel on which the OMRON devices are installed. The customer must, therefore, perform the final check to confirm that devices and the overall machine conform to EMC standards.

### Applicable EMC Standards

EMS (Electromagnetic Susceptibility): EN61131-2

EMI (Electromagnetic Interference): EN50081-2

(Radiated emission: 10-m regulations)

OMRON Power Supply Modules and I/O Modules have been determined safe when operating at voltages of 50 to 1,000 VAC and 75 to 1,500 VDC according to the safety standards in EN61131-2.

### Standards Description

U = UL, Underwriters Laboratories, Inc.

C = CSA, Canadian Standards Association

CE = CE, CE Marking

N = Nemko, Norges Elektriske Materiekkontroll

L = Lloyd's Register of shipping

Special Note: For current consumption, refer to *Current Consumption Tables* (the last 6 pages of this ordering guide).

<b>CPU Rack</b> .....	147
<b>Expansion Racks</b> .....	148
<b>C200H Basic I/O Modules</b> .....	149
B7A Terminals	
Link Master Adapters for High-density I/O PLC Modules	
<b>C200H High-density I/O Modules</b> .....	153
Connectors for C200H High-density I/O Modules	
<b>C200H Group-2 High-density I/O Modules</b> .....	154
Connectors for C200H Group-2 High-density I/O Modules	
<b>CS1 High-density I/O Modules</b> .....	155
Connectors for CS1 High-density I/O Modules	
<b>High-density I/O Screw Terminal Blocks and Cables</b> .....	156
Screw Terminal Block and Cables	
<b>High-density I/O Relay Blocks, Bases and Dedicated Cables</b> .....	157
G7TC Relay Blocks	
P7TF Block Bases and I/O Relays	
Accessories	
Relay Output Blocks	
Relay Terminal Block Bases	
Relays for use with G70A Bases	
Dedicated Connecting Cable for Omron PLC Modules	
<b>C200H Special I/O Modules</b> .....	160
<b>CS1 Special I/O Modules</b> .....	165
<b>CS1/C200H Non-compatible Modules</b> .....	167
Modules not compatible with CS1 Controllers or Systems	
<b>CS1 Communications and Network Modules</b> .....	168
Communications and Network Modules	
Fiber-Optic Cables and Connectors for Controller Link	
<b>DeviceNet Products</b> .....	169
<b>DeviceNet Multiple I/O Terminal Modules</b> .....	170
DeviceNet Communications Module	
Digital I/O Modules	
Relay Output Modules	
Analog I/O Modules	
Counter Module	
<b>CompoBus/S Slave Modules</b> .....	171
<b>Long Distance CompoBus/S Slave Modules (NEW!)</b> .....	172
<b>Optional Products</b> .....	173
Module Accessories	
Mounting Rails and Accessories	
<b>Current Consumption Tables</b> .....	174
CPU Racks and Expansion Racks	
SYSMAC BUS Slave Racks	
Example Calculations	
5 VDC Voltage Group .....	176
Basic I/O Modules	
High-density I/O Modules (Special I/O)	
Special I/O Modules	
CS1 CPU BUS Modules	
26 VDC Modules .....	181

System Overview

CPU Overview

Basic System Configuration

I/O Types and Allocations

Modules







Peripheral Hardware and Software

Instruction Set

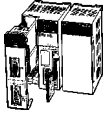
Ordering Guide



Reference Information









Item	Description			Standards	Part number
 <p>CPU Modules</p>	I/O bits	Program capacity	Data memory capacity	—	—
	960	10K steps	32K words (DM: 32K words, EM: None)	U, C, N, CE, L	<b>CS1G-CPU42-E(V□)</b>
	960	20K steps	32K words (DM: 32K words, EM: None)		<b>CS1G-CPU43-E(V□)</b>
	1280	30K steps	64K words (DM: 32K words, EM: 32K words × 1 bank)		<b>CS1G-CPU44-E(V□)</b>
	5120	60K steps	128K words (DM: 32K words, EM: 32K words × 3 banks)		<b>CS1G-CPU45-E(V□)</b>
	5120	20K steps	32K words (DM: 32K words, EM: None)		<b>CS1H-CPU63-E(V□)</b>
	5120	30K steps	64K words (DM: 32K words, EM: 32K words × 1 bank)		<b>CS1H-CPU64-E(V□)</b>
	5120	60K steps	128K words (DM: 32K words, EM: 32K words × 3 banks)		<b>CS1H-CPU65-E(V□)</b>
	5120	120K steps	256K words (DM: 32K words, EM: 32K words × 7 banks)		<b>CS1H-CPU66-E(V□)</b>
5120	250K steps	448K words (DM: 32K words, EM: 32K words × 13 banks)	<b>CS1H-CPU67-E(V□)</b>		
 <p>CPU Racks</p>	2 slots (does not connect to Expansion Rack)			U, C, N, CE, L	<b>CS1W-BC023</b>
	3 slots				<b>CS1W-BC033</b>
	5 slots				<b>CS1W-BC053</b>
	8 slots				<b>CS1W-BC083</b>
	10 slots				<b>CS1W-BC103</b>
 <p>Power Supplies</p>	100 to 120 VAC or 200 to 240 VAC; output capacity: 4.6 A, 5 VDC			U, C, N, L, CE	<b>C200HW-PA204</b>
	100 to 120 VAC or 200 to 240 VAC (with 0.8 A, 24 VDC service power supply) Output capacity: 4.6 A, 5 VDC				<b>C200HW-PA204S</b>
	100 to 120 VAC or 200 to 240 VAC (with RUN output) Output capacity: 4.6 A, 5 VDC			U, C	<b>C200HW-PA204R</b>
	100 to 120 VAC or 200 to 240 VAC (with RUN output) Output capacity: 9 A, 5 VDC			CE, L	<b>C200HW-PA209R</b>
	24 VDC, Output capacity: 4.6 A, 5 VDC			U, C, N, L, CE	<b>C200HW-PD024</b>
 <p>Memory Cards</p>	Flash memory, 8 MB			CE, L	<b>HMC-EF861</b>
	Flash memory, 15 MB				<b>HMC-EF171</b>
	Flash memory, 30 MB				<b>HMC-EF371</b>
	Memory Card adapter				<b>HMC-AP001</b>
<p>Serial Communications Boards</p>	2 × RS-232C ports (protocol macro function supported)			U, C, N, CE, L	<b>CS1W-SCB21</b>
	1 × RS-232C port + 1 × RS-422/485 port (protocol macro function supported)				<b>CS1W-SCB41</b>
 <p>Programming Consoles</p>	Requires an English Keyboard Sheet (CS1W-KS001-E). (connects to the peripheral port on CPU Module only)			U, C, N, CE,	<b>CQM1-PRO01-E</b>
					<b>C200H-PRO27-E</b>
 <p>Programming Console Connecting Cables</p>	Connects the CQM1-PRO01-E Programming Console. (0.05 m length) (adapter cable used with cable included with COM-PRO01-E)			CE	<b>CS1W-CN114</b>
	Connects the C200H-PRO27-E Programming Console. (2.0 m length)				<b>CS1W-CN224</b>
	Connects the C200H-PRO27-E Programming Console. (6.0 m length)				<b>CS1W-CN624</b>
CX-Programmer Software	Windows-based Programming Software for Windows 95, 98, NT4.0 (connects to peripheral port on CPU Module or RS-232C port on CPU Module or Serial Communications Module/Board.)			—	<b>WS02-CXPC1-EV□□</b>
CX-Protocol	Windows-based Protocol Development Software for Windows 95, 98, NT4.0			—	<b>WS02-PSTC1-E</b>
<p>Peripheral Device Connecting Cables (for peripheral port)</p>	Connects Standard IBM PC/AT compatible computers D-Sub 9-pin receptacle (Length: 0.1 m)			CE	<b>CS1W-CN118</b> (See Note.)
	Connects Standard IBM PC/AT compatible computers D-Sub 9-pin (2.0 m length)				<b>CS1W-CN226</b>
	Connects Standard IBM PC/AT compatible computers D-Sub 9-pin (6.0 m length)				<b>CS1W-CN626</b>
Peripheral Device Connecting Cables (for RS-232C port)	Serial Connecting Cable Connects Standard IBM PC/AT compatible computers D-Sub 9-pin (2.0 m length)			—	<b>C200HS-CN220-EU</b>
Battery Set	For CS1 Series only; provides backup to CPU memory			CE, L	<b>CS1W-BAT01</b>

Note: This is an adapter cable that is to be used with Omron Cable No. C200HS-CN220EU.

## Expansion Racks





Item	Description	Standards	Part number	
	3 slots	U, C, N, CE	<b>CS1W-BI033</b>	
	5 slots		<b>CS1W-BI053</b>	
	8 slots		<b>CS1W-BI083</b>	
	10 slots		<b>CS1W-BI103</b>	
	3 slots	U, C, N, L, CE	<b>C200HW-BI031</b>	
	5 slots		<b>C200HW-BI051</b>	
	8 slots		<b>C200HW-BI081</b>	
	10 slots		<b>C200HW-BI101</b>	
	100 to 120 VAC or 200 to 240 VAC, Output capacity: 4.6 A, 5 VDC	U, C, N, L, CE	<b>C200HW-PA204</b>	
	100 to 120 VAC or 200 to 240 VAC (with service supply: 0.8 A, 24 VDC), Output capacity: 4.6 A, 5 VDC		<b>C200HW-PA204S</b>	
	100 to 120 VAC or 200 to 240 VAC (with RUN output) Output capacity: 4.6 A, 5 VDC	U, C	<b>C200HW-PA204R</b>	
	24 VDC, 19.2 to 23.8 VDC Output capacity: 4.6 A, 5 VDC	U, C, N, L, CE	<b>C200HW-PD024</b>	
	100 to 120 VAC or 200 to 240 VAC (with RUN output) Output capacity: 9 A, 5 VDC	CE, L	<b>C200HW-PA209R</b>	
CS1 to CS1 Expansion I/O Rack Connecting Cables	Connects CS1 Expansion I/O Racks to CPU (CS1) Racks or other CS1 Expansion I/O Racks.	Length: 0.3 m	—	<b>CS1W-CN313</b>
		Length: 0.7 m		<b>CS1W-CN713</b>
		Length: 2 m		<b>CS1W-CN223</b>
		Length: 3 m		<b>CS1W-CN323</b>
		Length: 5 m		<b>CS1W-CN523</b>
		Length: 10 m		<b>CS1W-CN133</b>
		Length: 12 m		<b>CS1W-CN133-B2</b>
CS1 to C200HW Expansion I/O Rack Connecting Cables	Connects C200HW Expansion I/O Racks to CPU (CS1) Racks or CS1 Expansion I/O Racks.	Length: 0.3 m	—	<b>CS1W-CN311</b>
		Length: 0.7 m		<b>CS1W-CN711</b>
		Length: 2 m		<b>CS1W-CN221</b>
		Length: 3 m		<b>CS1W-CN321</b>
		Length: 5 m		<b>CS1W-CN521</b>
		Length: 10 m		<b>CS1W-CN131</b>
		Length: 12 m		<b>CS1W-CN131-B2</b>
C200HW to C200HW Expansion I/O Rack Connecting Cables	Connects C200HW Expansion I/O Racks to other C200HW Expansion I/O Racks.	Length: 0.3 m	N, L, CE, U	<b>C200H-CN311</b>
		Length: 0.7 m		<b>C200H-CN711</b>
		Length: 2 m		<b>C200H-CN221</b>
		Length: 5 m	L, CE	<b>C200H-CN521</b>
		Length: 10 m		<b>C200H-CN131</b>

Special Note: For current consumption, refer to *Current Consumption Tables* (the last 6 pages of this ordering guide).

Item	Description	Mountable racks				Bits allocated (CIO 0000 to CIO 0319)	Standards	Part number
		CPU rack	C200H expansion I/O racks	CS1 expansion racks	SYSMAC BUS slave racks			
DC Input Modules 	12 VDC, 64 pt	Yes	Yes	Yes	Yes	64	U, CE	<b>C200H-ID111</b>
	12 to 24 VDC, 8 inputs	Yes	Yes	Yes	Yes	16	U, C, N, L, CE	<b>C200H-ID211</b>
	24 VDC, 16 inputs	Yes	Yes	Yes	Yes	16		<b>C200H-ID212</b>
AC Input Modules 	100 to 120 VAC, 8 inputs	Yes	Yes	Yes	Yes	16	U, C, N, L	<b>C200H-IA121</b>
	100 to 120 VAC, 16 inputs	Yes	Yes	Yes	Yes	16	CE	<b>C200H-IA122</b>
	200 to 240 VAC, 8 inputs	Yes	Yes	Yes	Yes	16	U, C, N, L	<b>C200H-IA221</b>
	200 to 240 VAC, 16 inputs	Yes	Yes	Yes	Yes	16	CE	<b>C200H-IA222</b>
AC/DC Input Modules 	12 to 24 VAC/VDC, 8 inputs	Yes	Yes	Yes	Yes	16	U, C, N, L, CE	<b>C200H-IM211</b>
	24 VAC/VDC, 16 inputs	Yes	Yes	Yes	Yes	16		<b>C200H-IM212</b>
B7A Input Modules 	16 inputs	Yes	Yes	Yes	Yes	16	U, C, CE	<b>C200H-B7A11</b>
	32 inputs (C200H group-2 Module)	Yes	Yes	Yes	No	32	U, C	<b>C200H-B7A12</b>
Interrupt Input Module 	12 to 24 VDC, 8 inputs	Yes	No	No	No	16	U, C, CE	<b>C200HS-INT01</b>
Relay Output Modules 	250 VAC/24 VDC, 2 A, 8 outputs max.	Yes	Yes	Yes	Yes	16	U, C, N, CE	<b>C200H-OC221</b>
	250 VAC/24 VDC, 2 A, 12 outputs max.	Yes	Yes	Yes	Yes	16		<b>C200H-OC222</b>
	250 VAC/24 VDC, 2 A, 16 outputs max.	Yes	Yes	Yes	Yes	16	U, C, N, L, CE	<b>C200H-OC225</b>
	250 VAC/24 VDC, 2 A, 16 outputs max.	Yes	Yes	Yes	Yes	16		<b>C200H-OC226</b>
	250 VAC/24 VDC, 2 A, isolated contacts, 5 outputs max.	Yes	Yes	Yes	Yes	16	U, C, N, L	<b>C200H-OC223</b>
	250 VAC/24 VDC, 2 A, isolated contacts, 8 outputs max.	Yes	Yes	Yes	Yes	16		<b>C200H-OC224</b>

Special Note: For current consumption, refer to *Current Consumption Tables* (the last 6 pages of this ordering guide).

## C200H Basic I/O Modules

Item	Description	Mountable racks				Bits allocated (CIO 0000 to CIO 0319)	Standards	Part number
		CPU rack	C200H expansion I/O racks	CS1 expansion racks	SYSMAC BUS slave racks			
Transistor Output Modules 	12 to 48 VDC, 1 A, 8 sinking outputs	Yes	Yes	Yes	Yes	16	U, C, N, L, CE	<b>C200H-OD411</b>
	24 VDC, 2.1 A, 8 sinking outputs	Yes	Yes	Yes	Yes	16		<b>C200H-OD213</b>
	24 VDC, 0.8 A, 8 sourcing outputs, load short-circuit protection.	Yes	Yes	Yes	Yes	16	U, C, N, L	<b>C200H-OD214</b>
	5 to 24 VDC, 0.3 A, 8 sourcing outputs	Yes	Yes	Yes	Yes	16		<b>C200H-OD216</b>
	5 to 24 VDC, 0.3 A, 12 sinking outputs	Yes	Yes	Yes	Yes	16	U, C, N, L, CE	<b>C200H-OD211</b>
	24 VDC, 0.3 A, 12 sourcing outputs	Yes	Yes	Yes	Yes	16		<b>C200H-OD217</b>
	24 VDC, 0.3 A, 16 sinking outputs	Yes	Yes	Yes	Yes	16		<b>C200H-OD212</b>
	24 VDC, 1 A, 16 sourcing outputs, load short-circuit protection.	Yes	Yes	Yes	Yes	16	CE, U	<b>C200H-OD21A</b>
B7A Output Modules 	16 outputs	Yes	Yes	Yes	Yes	16	U, C, CE	<b>C200H-B7A01</b>
	32 outputs (C200H group-2 Module)	Yes	Yes	Yes	No	32	U, C	<b>C200H-B7A02</b>
B7A Mixed I/O Modules 	16 inputs, 16 outputs (C200H group-2 Module)	Yes	Yes	Yes	No	32	U, C	<b>C200H-B7A21</b>
	32 inputs, 32 outputs (C200H group-2 Module)	Yes	Yes	Yes	No	64	U, C	<b>C200H-B7A22</b>
Triac Output Module 	120 VAC, 1.2 A, 8 outputs	Yes	Yes	Yes	Yes	8	CE	<b>C200H-OA122E</b>
	250 VAC, 1.0 A, 8 outputs	Yes	Yes	Yes	Yes	16	CE	<b>C200H-OA221</b>
	250 VAC, 1.2 A, 8 outputs	Yes	Yes	Yes	Yes	16	CE	<b>C200H-OA223</b>
	250 VAC, 0.3 A, 12 outputs	Yes	Yes	Yes	Yes	16	CE, U	<b>C200H-OA222</b>
	250 VAC, 0.5 A, 12 outputs	Yes	Yes	Yes	Yes	16	U, C, N, L	<b>C200H-OA224</b>
Analog Timer Module 	4-point timer	Yes	Yes	Yes	Yes	16	U, C	<b>C200H-TM001</b>
	External variable resistor connector	—						

Special Note: For current consumption, refer to *Current Consumption Tables* (the last 6 pages of this ordering guide).

Note: The C200H-ID001 (no-voltage contacts, 8 inputs, NPN) and C200H-ID002 (no-voltage contacts, 8 inputs, PNP) cannot be used. (As a general reference, see the Non-compatible Models section within this Ordering Guide.)

### B7A Transistor I/O Link Modules

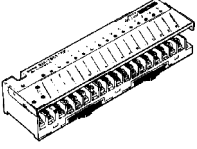
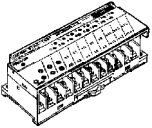
Item/Description						Part number
Appearance	I/O classification	I/O configuration	I/O delay (typical)	Internal I/O common	Error processing (See Note 1.)	
	Input, 16 points	NPN compatible	Normal speed 19.2 ms	- common	—	<b>B7A-T6A1</b> (See Note 2.)
				+/- common	—	<b>B7A-T6B1</b> (See Note 2.)
		PNP compatible	High speed 3 ms	+/- common	—	<b>B7A-T6C1</b>
				- common	—	<b>B7A-T6A6</b> (See Note 2.)
		NPN compatible	High speed 3 ms	+/- common	—	<b>B7A-T6B6</b> (See Note 2.)
				- common	—	<b>B7A-T6C6</b>
	Output, 16 points	NPN open collector 100 mA/point	Normal speed 19.2 ms	+ common	HOLD	<b>B7A-R6B11</b>
					LOAD OFF	<b>B7A-R6B31</b>
		NPN open collector 500 mA/point (See Note 3.)	Normal speed 19.2 ms	+ common	HOLD	<b>B7A-R6C11</b>
					LOAD OFF	<b>B7A-R6C31</b>
		PNP open collector 100 mA/point	Normal speed 19.2 ms	- common	HOLD	<b>B7A-R6F11</b>
					LOAD OFF	<b>B7A-R6F31</b>
		PNP open collector 500 mA/point (See Note 4.)	Normal speed 19.2 ms	- common	HOLD	<b>B7A-R6G11</b>
					LOAD OFF	<b>B7A-R6G31</b>
NPN open collector 100 mA/point		High speed 3 ms	+ common	HOLD	<b>B7A-R6B16</b>	
				LOAD OFF	<b>B7A-R6B36</b>	
NPN open collector 500 mA/point (See Note 3.)	High speed 3 ms	+ common	HOLD	<b>B7A-R6C16</b>		
			LOAD OFF	<b>B7A-R6C36</b>		
PNP open collector 100 mA/point	High speed 3 ms	- common	HOLD	<b>B7A-R6F16</b>		
			LOAD OFF	<b>B7A-R6F36</b>		
PNP open collector 500 mA/point (See Note 4.)	High speed 3 ms	- common	HOLD	<b>B7A-R6G16</b>		
			LOAD OFF	<b>B7A-R6G36</b>		
	Input, 16 points	NPN compatible	Normal speed 19.2 ms	+/- common	—	<b>B7AS-T6B1</b>
			High speed 3 ms		—	<b>B7AS-T6B6</b>
	Output, 16 points	NPN open collector 100 mA/point	Normal speed 19.2 ms	+/- common	HOLD	<b>B7AS-R6B11</b>
					LOAD OFF	<b>B7AS-R6B31</b>
			High speed 3 ms	+/- common	HOLD	<b>B7AS-R6B16</b>
					LOAD OFF	<b>B7AS-R6B36</b>

- Note: 1. HOLD: The previous output condition will be on hold when an error occurs.  
LOAD OFF: All outputs will be OFF when an error occurs.
2. The 16-point B7A-T6A□ and 16-point B7A-T6B□ are different from each other in terminal configuration.
3. N-channel MOSFET open drain output
4. P-channel MOSFET open drain output

## C200H Basic I/O Modules

### B7A Link Master Adapters for C200H High-density I/O Modules and Group-2 High-density I/O Modules

Item/Description						Part number
Appearance	I/O classification	I/O configuration	I/O delay (typical)	Internal I/O Common	Error processing	
	Input, 16 points	NPN compatible	Normal speed 19.2 ms	NA	—	<b>B7A-T6E3</b>
			High speed 3 ms	NA	—	<b>B7A-T6E8</b>
	Output, 16 points	NPN open collector 50 mA/point	Normal speed 19.2 ms	NA	HOLD	<b>B7A-R6A13</b>
					LOAD OFF	<b>B7A-R6A33</b>
			High speed 3 ms	NA	HOLD	<b>B7A-R6A18</b>
					LOAD OFF	<b>B7A-R6A38</b>
	Input, 32 points	NPN compatible	Normal speed 19.2 ms	NA	—	<b>B7A-T3E3</b>
			High speed 3 ms	NA	—	<b>B7A-T3E8</b>
	Output, 32 points	NPN open collector 50 mA/point	Normal speed 19.2 ms	NA	HOLD	<b>B7A-R3A13</b>
					LOAD OFF	<b>B7A-R3A33</b>
			High speed 3 ms	NA	HOLD	<b>B7A-R3A18</b>
					LOAD OFF	<b>B7A-R3A38</b>



## C200H High-density I/O Modules

Item 	Description	Mountable racks				Standards	Part number
		CPU Rack	C200H Expansion I/O Racks	CS1 Expansion Racks	SYSMAC BUS Slave Racks		
DC Input Modules	24 VDC, 32 inputs	Yes	Yes	Yes	Yes	U, C, N, L, CE	<b>C200H-ID215</b>
TTL Input Modules	5 VDC, 32 inputs	Yes	Yes	Yes	Yes		<b>C200H-ID501</b>
Transistor Output Modules	24 VDC, 32 sinking outputs	Yes	Yes	Yes	Yes		<b>C200H-OD215</b>
TTL Output Modules	5 VDC, 32 sinking outputs	Yes	Yes	Yes	Yes		<b>C200H-OD501</b>
TTL I/O Modules	5 VDC, 16 inputs, 16 sinking outputs	Yes	Yes	Yes	Yes		<b>C200H-MD501</b>
DC Input/Transistor Output Modules	24 VDC, 16 inputs, 16 sinking outputs	Yes	Yes	Yes	Yes	U, C	<b>C200H-MD215</b>
	12 VDC, 16 inputs, 16 sinking outputs	Yes	Yes	Yes	Yes		<b>C200H-MD115</b>

### Connectors for C200H High-density I/O Modules

Item	Connection	Fujitsu parts	Standards	Part number
Applicable Connectors	Solder-type (included with Module)	Socket: FCN-361J024-AU Connector bar: FCN-360C024-J2	—	<b>C500-CE241</b>
	Crimp-type	Socket: FCN-363J024 Connector bar: FCN-360C024-J2 Contacts: FCN-363J-AU		<b>C500-CE242</b>
	Ribbon-crimp	—		<b>C500-CE243</b>

Special Note: For current consumption, refer to *Current Consumption Tables* (the last 6 pages of this ordering guide).

## C200H Group-2 High-density I/O Modules



Item	Description	Mountable racks				Bits allocated (CIO 0000 to CIO 0319)	Standards	Part number
		CPU rack	C200H expansion I/O racks	CS1 expansion racks	SYSMAC BUS slave racks			
DC Input Modules 	24 VDC, 32 inputs	Yes	Yes	Yes	No	32	U, C, N, L, CE	<b>C200H-ID216</b>
	24 VDC, 64 inputs	Yes	Yes	Yes	No	64		<b>C200H-ID217</b>
	24 VDC, 32 inputs	Yes	Yes	Yes	No	32	U, C, CE	<b>C200H-ID218</b>
	12 VDC, 64 inputs	Yes	Yes	Yes	No	64	U, C	<b>C200H-ID111</b>
Transistor Output Modules	16 mA/4.5 V, or 100 mA/26.4 V, 32 sinking outputs	Yes	Yes	Yes	No	32	U, C, N, L, CE	<b>C200H-OD218</b>
	16 mA/4.5 V, or 100 mA/26.4 V, 64 sinking outputs	Yes	Yes	Yes	No	64		<b>C200H-OD219</b>
	24 VDC, O.SA, 32 sourcing outputs, load short-circuit protection	Yes	Yes	Yes	No	32	U, C, CE	<b>C200H-OD21B</b>

### Connectors for C200H Group-2 High-density I/O Modules

Item	Connection	Fujitsu parts	Standards	Part number
Applicable Connector	Solder-type (included with Module)	Socket: FCN-361J040-AU Connector bar: FCN-360C040-J2	—	<b>C500-CE404</b>
	Crimp-type	Socket: FCN-363J040 Connector bar: FCN-360C040-J2 Contacts: FCN-363J-AU		<b>C500-CE405</b>
	Ribbon-crimp type	FCN-367J040-AU		<b>C500-CE403</b>

# CS1 Ordering Guide

## CS1 High-density I/O Modules

Item	Description	Mountable racks				Bits allocated (CIO 0000 to CIO 0319)	Standards	Part number
		CPU rack	C200H expansion I/O racks	CS1 expansion racks	SYSMAC BUS slave racks			
DC Input Modules	24 VDC, 96 inputs	Yes	No	Yes	No	96	U, C, N, CE, L	<b>CS1W-ID291</b>
Transistor Output Modules 	12 to 24 VDC, 0.1 A, 96 sinking outputs	Yes	No	Yes	No	96	U, C, N, CE, L	<b>CS1W-OD291</b>
	12 to 24 VDC, 0.1 A, 96 sourcing outputs	Yes	No	Yes	No	96		<b>CS1W-OD292</b>
DC Input/Transistor Output Modules 	24 VDC, 0.1 A, 48 inputs, 48 outputs, sinking inputs/outputs	Yes	No	Yes	No	96 total 48 outputs, 48 inputs	U, C, N, CE, L	<b>CS1W-MD291</b>
	24 VDC, 0.1 A, 48 inputs, 48 outputs, sourcing inputs/outputs	Yes	No	Yes	No	96 total 48 outputs, 48 inputs		<b>CS1W-MD292</b>

### Connectors for CS1 High-density I/O Modules

Item	Connection	Description	Part number
Applicable Connectors	Solder-type (included with module)	Socket: FCN-361J056-AU Connector bar: FCN-360C056-J2	<b>CS1W-CE561</b>
	Crimp-type	Socket: FCN-363J056 Connector bar: FCN-360C056-J2 Contacts: FCN-363J-AU	<b>CS1W-CE562</b>
	Ribbon-type	FCN-367J056-AU	<b>CS1W-CE563</b>

## High-density I/O Screw Terminal Blocks and Cables

### Screw Terminal Blocks and Cables

Item/Description		Part number	
Appearance	Applicable terminal block	Cable length	
Single Cable for 32-pt I/O Modules 	<b>XW2B-20G5</b> <b>XW2B-20G4</b> <b>XW2B-20G5-T</b> <b>XW2B-20G5-D</b> <b>XW2C-20G5-IN16</b>	0.5 m (1.64 ft)	<b>XW2Z-050A</b>
		1 m (3.28 ft)	<b>XW2Z-100A</b>
		1.5 m (4.92 ft)	<b>XW2Z-150A</b>
		2 m (6.56 ft)	<b>XW2Z-200A</b>
		3 m (9.84 ft)	<b>XW2Z-300A</b>
		5 m (16.40 ft)	<b>XW2Z-500A</b>
Single cable for 32- and 64-pt I/O Modules 	<b>XW2B-40G5</b> <b>XW2B-40G4</b>	0.5 m (1.64 ft)	<b>XW2Z-050B</b>
		1 m (3.28 ft)	<b>XW2Z-100B</b>
		1.5 m (4.92 ft)	<b>XW2Z-150B</b>
		2 m (6.56 ft)	<b>XW2Z-200B</b>
		3 m (9.84 ft)	<b>XW2Z-300B</b>
		5 m (16.40 ft)	<b>XW2Z-500B</b>
Single Cable for CS1W High-density I/O Modules 	<b>XW2B-60G5</b> <b>XW2B-60G4</b>	1 m (3.28 ft)	<b>XW2Z-100H-1</b>
		2 m (6.56 ft)	<b>XW2Z-200H-1</b>
		3 m (9.84 ft)	<b>XW2Z-300H-1</b>
		5 m (16.40 ft)	<b>XW2Z-500H-1</b>
Bifurcated Cable for 32- and 64-pt I/O Modules 	<b>XW2C-20G5-IN16</b>	1 m (3.28 ft) and 0.75 m (2.46 ft)	<b>XW2Z-100D</b>
		1.5 m (4.92 ft) and 1.25 m (4.10 ft)	<b>XW2Z-150D</b>
		2 m (6.56 ft) and 1.75 m (5.74 ft)	<b>XW2Z-200D</b>
		3 m (9.84 ft) and 2.75 m (9.02 ft)	<b>XW2Z-300D</b>
		5 m (16.40 ft) and 4.75 m (15.58 ft)	<b>XW2Z-500D</b>
Bifurcated Cable for CS1W High-density I/O Modules 	<b>XW2B-40G5</b> <b>XW2B-20G5</b>	1 m (3.28 ft) and 1 m (3.28 ft)	<b>XW2Z-100H-2</b>
		2 m (6.56 ft) and 2 m (6.56 ft)	<b>XW2Z-200H-2</b>
		3 m (9.84 ft) and 3 m (6.56 ft)	<b>XW2Z-300H-2</b>
		5 m (16.40 ft) and 5 m (16.40 ft)	<b>XW2Z-500H-2</b>
96-pt connector Cable for CS1W I/O Modules (1:3) 	<b>Three XW2B-20G5</b>	1 m (3.28 ft) and 0.75 m (2.45 ft) and 1 m (3.28 ft)	<b>XW2Z-100H-3</b>
		2 m (6.56 ft) and 1.75 m (5.74 ft) and 2 m (6.56 ft)	<b>XW2Z-200H-3</b>
		3 m (9.84 ft) and 2.75 m (9.02 ft) and 3 m (9.84 ft)	<b>XW2Z-300H-3</b>
		5 m (16.40 ft) and 4.75 m (15.58 ft) and 5 m (16.40 ft)	<b>XW2Z-500H-3</b>
Single Cable terminated with crimp hooks (for 8-pt or 16-pt modules) 	<b>XW2B-20G5</b> <b>XW2B-20G4</b>	1 m (3.28 ft)	<b>XW2Z-100F</b>
		1.5 m (4.92 ft)	<b>XW2Z-150F</b>
		2 m (6.56 ft)	<b>XW2Z-200F</b>
		3 m (9.84 ft)	<b>XW2Z-300F</b>
		5 m (16.40 ft)	<b>XW2Z-500F</b>

## High-density I/O Relay Blocks, Bases and Dedicated Cables

### G7TC Relay I/O Blocks

Item/Description				Part number
I/O classification	I/O points	Internal I/O circuit common	Rated coil voltage	
Input	16 points	NPN (⊖ common)	24 VDC	<b>G7TC-ID16 DC24V</b>
				<b>G7TC-ID16-5 DC24V</b> (See Note 1.)
		NPN (⊖ common)	110/120 VAC	<b>G7TC-IA16 AC110/120V</b>
			220/240 VAC	<b>G7TC-IA16-5 AC100/110V</b> (See Note 1.)
Output (See Note 2.)	16 points	NPN (⊕ common)	12 VDC	<b>G7TC-OC16 DC12V</b>
			24 VDC	<b>G7TC-OC16 DC24V</b>
		PNP (⊖ common)	24 VDC	<b>G7TC-OC16-1 DC24V</b>
			8 points	NPN (⊕ common)
			24 VDC	<b>G7TC-OC08 DC24V</b>
			PNP (⊖ common)	24 VDC

Note: 1. The "-5" Block is for use with the DRT1-ID16X DeviceNet Remote adapter.  
 2. Output relays are rated up to 250 VAC. See *Specifications* (within the *G7TC data sheet*) for specific relay ratings.

### P7TF block bases and I/O Relays

Combine I/O Relays and P7TF Block Bases to match your application requirements. Use the table below to configure Relay I/O Blocks.

I/O points	Internal I/O circuit	Part number				
		Block Base	I/O Relay		Solid State Relay	
16 inputs (AC coil)	NPN (- common)	<b>P7TF-IS16 AC110/120V</b>	1 A	<b>G7T-1122S AC110/120 or G7T-1122S AC200/220V</b>	25 mA	<b>G3TA-IAZR02S AC100/240V</b>
16 inputs (DC coil)	NPN (- common)	<b>P7TF-IS16 DC24V</b>	1 A	<b>G7T-1122S DC24V</b>	25 mA	<b>G3TA-DZR02S DC5-24V</b>
16 outputs (DC coil)	NPN (+ common)	<b>P7TF-OS16 DC12V</b>	5 A	<b>G7T-1112S DC12V</b>	2 A	<b>G3TA-ODX02S 12VDC</b>
	NPN (+ common)	<b>P7TF-OS16 DC24V</b>	5 A	<b>G7T-1112S DC24V</b>	2 A	<b>G3TA-ODX02S DC24V or</b>
	PNP (- common)	<b>P7TF-OS16-1 DC24V</b>	5 A	<b>G7T-1112S DC24V</b>	1 A	<b>G3TA-OD201S DC24V</b>
8 outputs (DC coil)	NPN (+ common)	<b>P7TF-OS08 DC12V</b>	5 A	<b>G7T-1112S DC12V</b>	2 A	<b>G3TA-ODX02S 12VDC</b>
	NPN (+ common)	<b>P7TF-OS08 DC24V</b>	5 A	<b>G7T-1112S DC24V</b>	2 A	<b>G3TA-ODX02S DC24V or</b>
	PNP (- common)	<b>P7TF-OS08-1 DC24V</b>	5 A	<b>G7T-1112S DC24V</b>	1 A	<b>G3TA-OD201S DC24V</b>

### Accessories (order separately)

Item/Description	Part number
Single I/O socket for SPST and SPDT Relays	<b>P7TF-05</b>
Indicator module for AC (with varistor surge suppression)	<b>P70A</b>
Indicator module for DC (with diode surge suppression)	<b>P70D</b>
Output short circuit protection module	<b>G77-5</b>
Shorting bar	<b>G78-04</b>
Finger protection cover for 16 pt block	<b>G78-E</b>

## High-density I/O Relay Blocks, Bases and Dedicated Cables

### G70A Relay Terminal Block Bases

Relays not included. Order below.

Item/Description				Part number
Classification	PLC Module	Internal I/O circuit	Rated voltage	
Output	C200H-MD215 (16/16) C200H-OD215 (32) C200H-OD218 (32) C200H-OD219 (64) C200H-OD212 (16)	NPN (+ common)	24 VDC	<b>G70A-ZOC16-3-DC24V</b>
	C200H-OD214 (8 PNP) C200H-OD217 (12 PNP)	PNP (- common)	24 VDC	<b>G70A-ZOC16-4-DC24V</b>
Input	C200H-ID215 (32) C200H-MD215 (16/16) C200H-ID216 (32) C200H-ID217 (64) C200H-ID212 (16)	NPN/PNP	110 VDC max., 240 VAC max. (See Note.)	<b>G70A-ZIM16-5-DC24V</b>

Note: Each relay to be mounted must incorporate a coil that has proper specifications within the maximum rated voltage range.

### Relays for Use with G70A Bases

Item	Part number		
Classification	I/O Block Base	PCB Relay	Solid State Relay
Output	<b>NPN: G70A-ZOC16-3-DC24V</b> <b>PNP: G70A-ZOC16-4-DC24V</b>	<b>G2R-1-SND-DC24</b> <b>G2R-1-SND-DC12</b>	<b>G3R-OA202SZN DC5-24</b> <b>G3R-ODX02SN DC5-24</b> <b>G3R-OD201SN DC5-24</b>
Input	<b>G70A-ZIM16-5-DC24V</b>	<b>G2R-1A3-SND-DC24V</b> <b>G2R-13-SND-DC24V</b>	<b>G3R-IAZR1SN AC100-240</b> <b>G3R-IDZR1SN DC12-24</b> <b>G3R-IDZR1SN DC5</b>

### G70D Relay Output Blocks

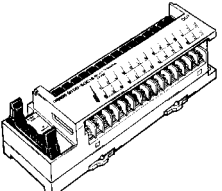
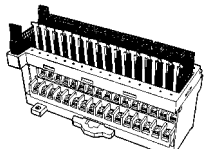
Item/Description					Part number
Appearance	Output points	Rated voltage	Output type	Internal I/O circuit common	
	16 points (SPST-NO x 16) includes relay pulling tool.	24 VDC	Relay outputs	NPN (+ common)	<b>G70D-SOC16 DC24</b>
				PNP (- common)	<b>G70D-SOC16-1 DC24</b>
			Power MOSFET relay outputs	NPN (+ common)	<b>G70D-FOM16</b>
				PNP (- common)	<b>G70D-FOM16-1 DC24</b>
	16 points (SPST-NO x 16)	24 VDC	Relay outputs	NPN (+ common)	<b>G70D-VSOC16</b>
			Power MOSFET relay outputs	NPN (+ common)	<b>G70D-VFOM16</b>





## High-density I/O Relay Blocks, Bases and Dedicated Cables

### Dedicated Connecting Cables for Omron PLC Modules

The following cables are designed to connect directly to Omron PLC modules and have dedicated connectors for specific models.







Item	Length	Part number
Connecting Cable with three connectors for CS1 Series 96-pt High-density I/O Modules 	1.5 m (4.92 ft) + 1.25 m (4.10 ft) + 1 m (3.28 ft)	<b>G79-150C-125-100</b>
	2 m (6.56 ft) + 1.75 m (5.74 ft) + 1.5 m (4.92 ft)	<b>G79-200C-175-150</b>
	3 m (9.84 ft) + 2.75 m (9.02 ft) + 2.5 m (8.20 ft)	<b>G79-300C-275-250</b>
Connecting Cable with two connectors for C200H 32-pt and 64-pt Group-2 High-density I/O Modules 	1 m (3.28 ft) + 0.75 m (2.46 ft)	<b>G79-O100C-75</b>
	1.5 m (4.92 ft) + 1.25 m (4.10 ft)	<b>G79-O150C-125</b>
	2 m (6.56 ft) + 1.75 m (5.74 ft)	<b>G79-O200C-175</b>
	3 m (9.84 ft) + 2.75 m (9.02 ft)	<b>G79-O300C-275</b>
	5 m (16.40 ft) + 4.75 m (15.58 ft)	<b>G79-O500C-475</b>
Connecting Cable with one connector for C200H 32-pt High-density I/O Modules 	1 m (3.28 ft)	<b>G79-100C</b>
	1.5 m (4.92 ft)	<b>G79-150C</b>
	2 m (6.56 ft)	<b>G79-200C</b>
	3 m (9.84 ft)	<b>G79-300C</b>
	5 m (16.40 ft)	<b>G79-500C</b>

## C200H Special I/O Modules

Item	Description	Mountable racks				Standards	Part number
		CPU Rack	C200H Expansion I/O Racks	CS1 Expansion Racks	SYSMAC BUS Slave Racks		
Temperature Control Modules 	Thermocouple input, time-proportioning PID, or ON/OFF transistor output	Yes	Yes	Yes	Yes	U, C	<b>C200H-TC001</b>
	Thermocouple input, time-proportioning PID, or ON/OFF voltage output	Yes	Yes	Yes	Yes	U	<b>C200H-TC002</b>
	Thermocouple input, PID current output	Yes	Yes	Yes	Yes		<b>C200H-TC003</b>
	RTD input, time-proportioning PID, or ON/OFF transistor output	Yes	Yes	Yes	Yes		<b>C200H-TC101</b>
	RTD input, time-proportioning PID, or ON/OFF voltage output	Yes	Yes	Yes	Yes		<b>C200H-TC102</b>
	RTD input, PID current output	Yes	Yes	Yes	Yes		<b>C200H-TC103</b>
Data Setting Console 	Used with Temperature Control Modules. Monitoring, setting, and changing present values, set points, alarm values, PID parameters, bank numbers, etc.	—				U	<b>C200H-DSC01</b>
	Connecting Cable, 2 m	—				—	<b>C200H-CN225</b>
	Connecting Cable, 4 m	—				—	<b>C200H-CN425</b>
Heat/Cool Temperature Control Modules 	Thermocouple input, time-proportioning PID, or ON/OFF transistor output	Yes	Yes	Yes	Yes	U	<b>C200H-TV001</b>
	Thermocouple input, time-proportioning PID, or ON/OFF voltage output	Yes	Yes	Yes	Yes		<b>C200H-TV002</b>
	Thermocouple input, PID current output	Yes	Yes	Yes	Yes		<b>C200H-TV003</b>
	RTD input, time-proportioning PID, or ON/OFF transistor output	Yes	Yes	Yes	Yes		<b>C200H-TV101</b>
	RTD input, time-proportioning PID, or ON/OFF voltage output	Yes	Yes	Yes	Yes		<b>C200H-TV102</b>
	RTD input, PID current output	Yes	Yes	Yes	Yes		<b>C200H-TV103</b>
Temperature Sensor Modules 	Thermocouple input, K(CA) or J(IC), selectable	Yes	Yes	Yes	Yes	U, C	<b>C200H-TS001</b>
		Yes	Yes	Yes	Yes		<b>C200H-TS002</b>
	RTD input, Pt 100 Ω, conforms to JIS standards	Yes	Yes	Yes	Yes		<b>C200H-TS101</b>
	RTD input, Pt 100 Ω	Yes	Yes	Yes	Yes		<b>C200H-TS102</b>
Voice Module	Voice/Audio input and output for system notification	Yes	Yes	Yes	Yes	U,C	<b>C200H-OV001</b>

Special Note: For current consumption, refer to *Current Consumption Tables* (the last 6 pages of this ordering guide).





Item	Description	Mountable racks				Standards	Part number
		CPU Rack	C200H Expansion I/O Racks	CS1 Expansion Racks	SYSMAC BUS Slave Racks		
Process Control Modules 	Voltage or current input, time-proportioning PID, or ON/OFF transistor output	Yes	Yes	Yes	Yes	U	C200H-PID01
	Voltage or current input, time-proportioning PID, or ON/OFF voltage output	Yes	Yes	Yes	Yes		C200H-PID02
	Voltage or current input, PID current output	Yes	Yes	Yes	Yes		C200H-PID03
Data Setting Console 	Used with PID Control Modules. Monitoring, setting, and changing present values, set points, alarm values, PID parameters, bank numbers, etc.	—				U	C200H-DSC01
	Connecting Cable, 2 m	—				—	C200H-CN225
	Connecting Cable, 4 m	—				—	C200H-CN425
Cam Positioner Module 	48 cam outputs (16 external outputs and 32 internal outputs), Resolver speed: 20 μs (5 kHz)	Yes	Yes	Yes	Yes	U, C	C200H-CP114
Data Setting Console 	Used with Cam Positioner Module. Monitoring, setting, and changing present values, set points, alarm values, PID parameters, bank numbers, etc.	—				U	C200H-DSC01
	Connecting Cable, 2 m	—				—	C200H-CN225
	Connecting Cable, 4 m	—				—	C200H-CN425
ASCII/BASIC Modules 	24-kbyte RAM, 2 RS-232C ports	Yes	Yes	Yes	Yes	N, CE	C200H-ASC02
	200-kbyte RAM, 2 RS-232C ports	Yes	Yes	Yes	Yes	U, C, CE	C200H-ASC11
	200-kbyte RAM, RS-232C port, RS-422/485 port	Yes	Yes	Yes	Yes		C200H-ASC21
	200-kbyte RAM, 3 RS-232C ports (1 terminal only)	Yes	Yes	Yes	Yes		C200H-ASC31
Analog Input Modules (See Note.) 	4 to 20 mA, 1 to 5/0 to 10 V (selectable), 4 inputs, 1/4,000 resolution	Yes	Yes	Yes	Yes	U, C, N, L	C200H-AD001
	4 to 20 mA, 1 to 5/0 to 10 V/-10 to +10 V (selectable); 8 inputs; 1/4,000 resolution	Yes	Yes	Yes	Yes	U, C, N, L, CE	C200H-AD002
	4 to 20 mA, 1 to 5/0 to 10 V/-10 to +10 V (selectable); 8 inputs; 1/4,000 resolution	Yes	Yes	Yes	Yes		C200H-AD003





Note: CS1 Series versions are available; please refer to the CS1 Special I/O subsection within this *Ordering Guide* Section.

Special Note: For current consumption, refer to *Current Consumption Tables* (the last 6 pages of this ordering guide).

## C200H Special I/O Modules

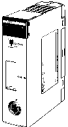
Item	Description	Mountable racks				Standards	Part number	
		CPU Rack	C200H expansion I/O Racks	CS1 Expansion Racks	SYSMAC BUS Slave Racks			
Analog Output Modules * 	4 to 20 mA, 1 to 5 V, 0 to 10 V (selectable); 2 outputs; 1/4,000 resolution	Yes	Yes	Yes	Yes	U, C, N, L	<b>C200H-DA001</b>	
	4 to 20 mA, -10 to +10 V (selectable), 4 outputs; 1/4,000 resolution	Yes	Yes	Yes	Yes	U, C, N, L, CE	<b>C200H-DA002</b>	
	1 to 5 V, -10 to +10 V (selectable), 8 outputs; 1/4,000 resolution	Yes	Yes	Yes	Yes		<b>C200H-DA003</b>	
	4 to 20 mA, 8 outputs; 1/4,000 resolution	Yes	Yes	Yes	Yes		<b>C200H-DA004</b>	
Analog I/O Modules * 	2 inputs (4 to 20 mA, 1 to 5 V, etc.) 2 outputs (4 to 20 mA, 1 to 5 V etc.)	Yes	Yes	Yes	Yes		<b>C200H-MAD01</b>	
High-speed Counter Modules 	One-axis pulse input, counting rate: 50 kcps max.	Yes	Yes	Yes	Yes	U, C, CE	<b>C200H-CT001-V1</b>	
	One-axis pulse input, counting rate: 75 kcps max., line driver compatible	Yes	Yes	Yes	Yes		<b>C200H-CT002</b>	
	Two-axis pulse input, counting rate: 75 kcps max., line driver compatible	Yes	Yes	Yes	Yes		<b>C200H-CT021</b>	
	Solder terminal; 40-pin and a Connector Cover		—	—	—	—		<b>C500-CE401</b>
	Solderless terminal; 40-pin and a Connector Cover (Crimp-type)		—	—	—	—		<b>C500-CE402</b>
	Pressure welded terminal; 40-pin		—	—	—	—		<b>C500-CE403</b>
	Solder terminal; 40-pin and a Connector Cover (Horizontal-type)		—	—	—	—		<b>C500-CE404</b>
	Crimp-style terminal; 40-pin and a Connector Cover (Horizontal-type)		—	—	—	—		<b>C500-CE405</b>
Motion Control Modules * 	G-language programmable, two-axis analog outputs	Yes	Yes	Yes	Yes	U, C, CE	<b>C200H-MC221</b>	
	MC Support Software IBM PC/AT or compatible	—	—	—	—	—	<b>CV500-ZN3AT1-E</b>	
	Connecting Cable: 3.3 m	—	—	—	—	—	<b>CQM1-CIF01</b>	
	Teaching Box	—	—	—	—	U, C, CE	<b>CVM1-PRO01</b>	
	Connection Cable for Teaching Box: 2 m long	—	—	—	—	—	<b>CV500-CN224</b>	
	Memory Pack (with key sheet)	—	—	—	—	—	<b>CVM1-MP702</b>	
	Terminal Block Conversion Module Simplifies wiring.	—	—	—	—	—	<b>XW2B-20J6-6</b>	
	Connecting cable for Terminal Block Conversion Module	—	—	—	—	—	<b>XW2Z-100J-F1</b>	
	Connecting Cable (to servo drive)	—	—	—	—	—	<b>R88A-CPU001-M1</b>	

Special Note: For current consumption, refer to *Current Consumption Tables* (the last 6 pages of this ordering guide). \*See CS1 Versions - several pages forward.

Item	Description	Mountable Racks				Standards	Part number
		CPU Rack	C200H Expansion I/O Racks	CS1 Expansion Racks	SYSMAC BUS Slave Racks		
Position Control Modules 	One-axis pulse output, speeds 1 to 500,000 pps, directly connects to servomotor driver, line driver compatible (Z level)	Yes	Yes	Yes	Yes	U, C, CE	<b>C200HW-NC113</b>
	Two-axis pulse output, speeds 1 to 500,000 pps, directly connects to servomotor driver, line driver compatible (Z level)	Yes	Yes	Yes	Yes	U, C, CE	<b>C200HW-NC213</b>
	Four-axis pulse output, speeds 1 to 500,000 pps, directly connects to servomotor driver, line driver compatible (Z level)	Yes	Yes	Yes	Yes		<b>C200HW-NC413</b>
	1-axis cable for C200HW-NC113	—				—	<b>XW2Z-□□□J-A6</b> (See Note 1.)
	1-axis Servo Relay Module for C200HW-NC113	—					<b>XW2B-20J6-1B</b>
	2-axis cable for C200HW-NC213	—					<b>XW2Z-□□□J-A7</b> (See Note 1.)
	2-axis Servo Relay Module for C200H-NC213	—					<b>XW2B-40J6-2B</b>
RFID Controller Modules 	Electromagnetic coupling, allows interface to RFID systems	Yes	Yes	Yes	Yes	U, C	<b>C200H-IDS01-V1</b>
	Microwave type, allows interface to RFID systems	Yes	Yes	Yes	Yes	—	<b>C200H-IDS21</b>
DeviceNet Master Module 	DeviceNet Remote I/O Master, 50 nodes max., (without "configurator"); 63 nodes max. (with "configurator").	Yes	Yes	Yes	No	U, C, N, L, CE	<b>C200HW-DRM21-V1</b> (See Note 2.)
DeviceNet I/O Link Module 	DeviceNet Remote I/O Slave, supports 512 input points. and 512 output points. For details on Slave Modules, refer to the <i>DeviceNet</i> subsection (found a few pages forward within this section).	Yes	Yes	Yes	No	U, C, N, CE	<b>C200HW-DRT21</b>
CompoBus/S Master Modules 	CompoBus/S Remote I/O, 32 slaves/256 bits max. For details on Slave Modules, refer to the <i>DeviceNet</i> subsection (found a few pages forward within this section).	Yes	Yes	Yes	No	U, C, N, L, CE	<b>C200HW-SRM21-V1</b>



Special Note: For current consumption, refer to *Current Consumption Tables* (the last 6 pages of this ordering guide).

Note: 1. Options for □□□ include the following:

- 050 = 0.5 meter length
- 100 = 1.0 meter length
- 200 = 2.0 meter length
- 300 = 3.0 meter length
- 500 = 5.0 meter length

2. The DeviceNet Slaves are allocated up to 2,048 I/O bits (100 words) in the DeviceNet Memory Area.

## C200H Special I/O Modules

Item	Description	Mountable Racks				Standards	Part number
		CPU Rack	C200H Expansion I/O Racks	CS1 Expansion Racks	SYSMAC BUS Slave Racks		
PC Link Module 	PC Link, single level: 32 Modules; multilevel: 16 Modules	Yes	Yes	Yes	No	N, L, CE	<b>C200H-LK401</b> (See Note 1.)
SYSMAC BUS Remote I/O Master Modules 	Wired	Yes	Yes	Yes	No	N, L, CE	<b>C200H-RM201</b> (See Note 2.)
	Fiber-optic	Yes	Yes	Yes	No	N, L, CE	<b>C200H-RM001-PV1</b> (See Note 2.)

Special Note: For current consumption, refer to *Current Consumption Tables* (the last 6 pages of this ordering guide).

- Note:
1. PC Link Modules are allocated up to 1,024 bits (64 words) in the Link Area.
  2. Each Slave Rack connected to a Remote I/O Master Module is allocated 10 words in the SYSMAC BUS Area. Each I/O Terminal is allocated 1 word in the I/O Terminal Area.
  3. SYSMAC BUS Remote I/O Slave Devices, Cables, and Accessories can be found in manual W120, Appendix A.

### CS1 Motion Control Modules

Item	Description	Mountable racks				Standards	Part number
		CPU Rack	C200HW Expansion Racks	CS1 Expansion Racks	SYSMAC BUS Slave Racks		
Motion Control Modules	CS1W Analog Motion Module, 2-axis	Yes	No	Yes	No	U, C, N, CE, L	CS1W-MC221
	CS1W Analog Motion Module, 4-axis						CS1W-MC421
Configuration Software	CX-Motion Configuration Software for MC Type Modules					—	WS02-MCTC1-E

### Peripheral Devices (for Motion Control Modules)

Item/Description		Part number		
Teaching Box		CVM1PRO01-E		
R <sub>ON</sub> Cassette		CVM1-MP702		
Terminal Block for 2 Axes		XW2B-20J6-6		
Terminal Block for 4 Axes		XW2B-40J6-7		
Terminal Block Cable		XW2Z-100J-F1		
Servo Drive Cables	H-Series	Cable for 1 axis	1 m	R88A-CPH001M1
			2 m	R88A-CPH002M1
		Cable for 2 axes	1 m	R88A-CPH001M2
			2 m	R88A-CPH002M2
	M-Series	Cable for 1	1 m	R88A-CPM001M1
			2 m	R88A-CPM002M1
		Cable for 2 axes	1 m	R88A-CPM001M2
			2 m	R88A-CPM002M2
	U-Series up to 750 W	Cable for 1 axes	1 m	R88A-CPU001M1
			2 m	R88A-CPU002M1
		Cable for 2 axes	1 m	R88A-CPU001M2
			2 m	R88A-CPU002M2
	U-Series from 1 to 5 kW	Cable for 1 axis	1 m	R88A-CPB001M1
			2 m	R88A-CPB002M1
Cable for 2 axes		1 m	R88A-CPB001M2	
		2 m	R88A-CPB002M2	
Personal Computer Cables for CX-Motion Software (See Note.)	Peripheral port	0.1 m	CS1W-CN118	
		2 m	CS1W-CN226	
		6 m	CS1W-CN626	
	RS-232C port	2 m	XW2Z-200S-V	
		5 m	XW2Z-500S-V	

Note: To connect to a CS1 Series CPU Module.

## CS1 Special I/O Modules

### CS1 Analog Modules

Item	Description	Mountable racks				Standards	Part number
		CPU Rack	C200HW Expansion Racks	CS1 Expansion Racks	SYSMAC BUS Slave Racks		
Analog Input Modules	Module, analog IN, 4-channel, CS1	Yes	No	Yes	No	U, C, N, CE, L	<b>CS1W-AD041</b>
	Module, analog IN, 8-channel, CS1						<b>CS1W-AD081</b>
Analog Output Modules	Module, analog OUT, 8-channel (V), CS1						<b>CS1W-DA041</b>
	Module, analog OUT, 8-channel (A), CS1						<b>CS1W-DA08C</b>
Analog I/O Modules	Module, CS1 mixed analog 4 IN, 4 OUT					<b>CS1W-MAD44</b>	

## CS1/C200H Non-compatible Modules

### Modules Not Compatible with CS1 Controllers or Systems

The modules listed in the non-compatible part number column cannot be used anywhere within a CS1 System, on a CPU Rack or on CS1/C200HW Expansion Racks. Please contact your Omron Sales Representative for assistance when upgrading existing systems to CS1 systems (i.e., changing from a system with these non-compatible modules).

Note: Many options are available in addition to the suggested replacement module listed here (last column).

Item	Description	Mountable Racks				Part numbers of modules not compatible with CS1 controllers or systems	Suggested replacement part number (See Note.)
		CPU Rack	C200HW Expansion Racks	CS1 Expansion Racks	SYSMAC BUS Slave Racks		
Input Module	8-pt Input, No-volt, NPN	No	No	No	No	C200H-ID001	<b>C200H-ID211</b>
	8-pt Input, No-volt, PNP					C200H-ID002	<b>C200H-ID211</b>
Network Module	HostLink RS-232 Modules					C200H-LK201(-V1)	<b>CS1W-SCU21</b>
	HostLink RS-422 Modules					C200H-LK202(-V1)	<b>CS1W-SCU21</b> <b>CS1W-SCB41</b>
	SYSMAC Link Module, fiber-optic					C200H-SLK11	<b>CS1W-CLK11</b>
	SYSMAC Link Module, wire					C200H-SLK21(-V1)	<b>CS1W-CLK21</b>
	SYSMAC Link Module, fiber-optic					C200HS-SLK12	<b>CS1W-CLK11</b>
	SYSMAC Link Module, wire					C200HS-SLK22	<b>CS1W-CLK21</b> <b>CS1W-CLK11</b>
	SYSMAC Net Module					C200HS-SNT32	<b>CS1W-CLK21</b> <b>CS1W-CLK11</b>
	Controller Link Module					C200HW-CLK21	<b>CS1W-CLK21</b> <b>CS1W-CLK11</b>
	PC Card module					C200HW-PCU01-E	<b>Compact Flash within CS1 CPU</b>
	PC Card with ethernet support					C200HW-PCS01-E(V1)	<b>CS1W-ETN01</b>
	SYSMAC Link Module, fiber-optic					C200HW-SLK13	<b>CS1W-CLK11</b>
	SYSMAC Link Module, fiber-optic, 3K data					C200HW-SLK14	<b>CS1W-CLK11</b>
	SYSMAC Link Coax Module					C200HW-SLK23	<b>CS1W-CLK21</b>
SYSMAC Link Coax Module, 3K data	C200HW-SLK24	<b>CS1W-CLK21</b>					

## CS1 Communications and Network Modules

### Communications and Network Modules

Item 	Description	Mountable racks				Words allocated (CIO 1500 to CIO 1899)	Standards	Part number
		CPU Rack	C200H Expansion I/O Racks	CS1 Expansion Racks	SYSMAC BUS Slave Racks			
Controller Link Modules	Wired	Yes	No	Yes	No	25 words	U, C, N, CE, L	<b>CS1W-CLK21</b>
	Fiber-optic	Yes	No	Yes	No	25 words		<b>CS1W-CLK11</b>
Serial Communications Module	Two RS-232C Ports	Yes	No	Yes	No	25 words		<b>CS1W-SCU21</b>
Ethernet Module	FINS communications, TCP/IP and UDP/IP Socket Services, FTP server, email notification	Yes	No	Yes	No	25 words		<b>CS1W-ETN01</b>

Special Note: For current consumption, refer to *Current Consumption Tables* (the last 6 pages of this ordering guide).

### Fiber-optic Cables and Connectors for Controller Link

Item/Description	Comments	Part number
Connector, half lock	—	<b>S3200-COCF2511</b>
Connector, full lock	Two required for each module or NSB.	<b>S3200-COCF2011</b>
Fiber-optic cable, duplex, zipcord, 50M	Use for short runs; do not pull through conduit. Orange color.	<b>FCS-HCR-CO-501</b>
Fiber-optic cable, duplex, jacketed, 50M	Use for pulling through conduit. Black jacket with stress members. Custom jackets for burial, and special environments are available for custom orders.	<b>FCS-HCR-LB-501</b>
Fiber-optic cable, duplex, jacketed, 100 M		<b>FCS-HCR-LB-102</b>
Fiber-optic cable, duplex, jacketed, 500 M		<b>FCS-HCR-LB-501</b>
Fiber-optic cable, duplex, jacketed, 1000 M		<b>FCS-HCR-LB-103</b>

- Note:
1. Connectors and cables must be purchased separately from the modules and NSB's.
  2. Cable is bulk, non-terminated.
  3. Termination kit required to attach connectors to cable.
  4. Cable testing and termination assistance is available.
  5. Special pre-terminated cables are available by special order.



Item/Description				Part number
Group	Module/Terminal	I/O points	Standards	
Basic Terminals and Modules	Remote Transistor Input Terminals	8 inputs	U, C	DRT1-ID08-DC24-1
		16 inputs		DRT1-ID16-DC24
	Remote Transistor Output Terminals	8 outputs		DRT1-OD08
		16 outputs		DRT1-OD16
	Environmentally Resistant Transistor I/O Terminals	8 inputs	CE	DRT1-ID08C
		8 outputs		DRT1-OD08C-DC24
		8 inputs and 8 outputs		DRT1-MD16C
		16 point input, NPN		DRT1-HD16C
		16 point output, PNP		DRT1-HD16C-1
		16 point input, NPN		DRT1-WD16C
		16 point output, PNP		DRT1-WD16C-1
	8 inputs, 8 outputs, PNP	DRT1-MD16C-1		
	Basic Terminals and Modules	Remote Adapters	16 inputs	U, C
16 outputs			DRT1-OD16X-DC24	
Sensor Terminals		16 inputs	—	DRT1-HD16S
		8 inputs and 8 outputs		DRT1-ND16S
Temperature Input Terminals		4 inputs (4 words)		DRT1-TS04T
				DRT1-TS04P
CQM1 I/O Link Module		16 inputs and 16 outputs	U, C, CE	CQM1-DRT21
Analog Terminals	Analog Input Terminals	2 or 4 inputs (2 or 4 words) (voltage or current)	CE	DRT1-AD04
		4 inputs (4 words) (voltage or current)	—	DRT1-AD04H
	Analog Output Terminals	2 outputs (2 words)	CE	DRT1-DA02
Special Modules and Terminals	C200H I/O Link Module	512 inputs (32 words) max. 512 outputs (32 words) max.	U, C, N, CE	C200HW-DRT21
	RS-232C Module	16 inputs (1 word)	U, C, CE	DRT1-232C2
	B7AC Interface Terminal	30 points (10 words/B7AC)	CE	DRT1-B7AC
Optional Parts	T-branch Taps	1-branch Tap	—	DCN1-1
		1-branch Tap with Connectors		DCN1-1C
		3-branch Tap		DCN1-3
		3-branch Tap with Connectors		DCN1-3C
	Special Cables	Thin	DCA1-5C10	
		Thick	DCA2-5C10	
	Terminal Block with Terminating Resistance	—	DRS1-T	

## DeviceNet Multiple I/O Terminal Modules

### DeviceNet Communications Module

Item/Description				Part number
Number of slaves	Number of slave I/O points	Rated voltage	Standards	DRT1-COM
8	1,024 max., input and output combined	24 VDC	U, C, CE	

### Digital I/O Modules

Item	Classification	Internal I/O circuit common	I/O points	I/O connections	I/O specifications	Standards	Part number	
Terminal Block-type Digital I/O Modules	Digital input	NPN (+ common)	16	M3 terminal block	DC/Tr	U, C, CE	GT1-ID16	
		PNP (- common)					GT1-ID16-1	
	Digital output	NPN (- common)			0.5 A DC/Tr		GT1-OD16	
		PNP (+ common)			GT1-OD16-1			
Connector-type Digital I/O Modules	Digital input	NPN (+ common)		Molex connectors	DC/Tr	0.5 A DC/Tr	U, C, CE	GT1-ID16MX
		PNP (- common)						GT1-ID16MX-1
	Digital output	NPN (- common)			GT1-OD16MX			
		PNP (+ common)			GT1-OD16MX-1			
	Digital input	NPN (+ common)	Fujitsu connectors	DC/Tr	CE	0.5 A DC/Tr	GT1-ID16ML	
		PNP (- common)					GT1-ID16ML-1	
	Digital output	NPN (- common)	GT1-OD16ML					
		PNP (+ common)	GT1-OD16ML-1					
Digital input	NPN (+ common)	25-pin D-sub connectors	DC/Tr	0.5 A DC/Tr	U, C, CE	GT1-ID16DS		
						PNP (- common)	GT1-ID16DS-1	
	Digital output		NPN (- common)			GT1-OD16DS		
			PNP (+ common)			GT1-OD16DS-1		
Multi-point Connector-type Digital I/O Modules	Digital input	NPN (+ common)	32	Fujitsu connectors	DC/Tr	U, C, CE	GT1-ID32ML	
		PNP (- common)					GT1-ID32ML-1	
	Digital output	NPN (- common)		GT1-OD32ML				
		PNP (+ common)		GT1-OD32ML-1				

### Relay Output Modules

Item	I/O points	I/O connection method	Description	Standards	Part number
Relay Output	16 points	M3 terminal block	2 A, AC, DC, SPST-NO	CE	GT1-ROS16
	8 points		5 A, AC, DC, SPST-NO	U, L, CE	GT1-ROP08

### Analog I/O Modules

Item	I/O	I/O connections	Description	Standards	Part number
Analog Input Module	8 inputs	Connectors	4 to 20 mA, 0 to 20 mA, 0 to 5 V, 1 to 5 V, 0 to 10 V, -10 to 10 V	U, C, CE	GT1-AD08MX
	4 inputs	Terminal block			GT1-AD04
Analog Input Module	8 inputs	Connectors	4 to 20 mA, 0 to 20 mA, 0 to 5 V, 1 to 5 V, 0 to 10 V, -10 to 10 V	U, L, CE	GT1-AD08MX
	4 inputs	Terminal block			GT1-AD04
Analog Output Module	4 outputs	Connector	0 to 5 V, 1 to 5 V, 0 to 10 V, -10 to 10 V	U, C, CE	GT1-DA04MX
		Terminal block	0 to 5 V, 1 to 5 V, 0 to 10 V, -10 to 10 V, 4 to 20 mA		GT1-DA04

### Counter Module

Item	External I/O	I/O connection method	Operating mode	Standards	Part number
Counter Module	1 input, 2 outputs	Terminal block (M3 terminals)	Linear counter	CE	GT1-CT01





Item (Slave type)	Description	Standards	Part number (See Note.)
Remote I/O Transistor Terminals	4 inputs (NPN)	U, C, CE	<b>SRT1-ID04</b>
	4 inputs (PNP)		<b>SRT1-ID04-1</b>
	8 inputs (NPN)		<b>SRT1-ID08</b>
	8 inputs (PNP)		<b>SRT1-ID08-1</b>
	16 inputs (NPN)		<b>SRT1-ID16</b>
	16 inputs (PNP)		<b>SRT1-ID16-1</b>
	4 outputs (NPN)		<b>SRT1-OD04</b>
	4 outputs (PNP)		<b>SRT1-OD04-1</b>
	8 outputs (NPN)		<b>SRT1-OD08</b>
	8 outputs (PNP)		<b>SRT1-OD08-1</b>
	16 outputs (NPN)		<b>SRT1-OD16</b>
	16 outputs (PNP)		<b>SRT1-OD16-1</b>
Remote I/O Relay Output Blocks	8 relay outputs	U, C, CE	<b>SRT1-ROC08</b>
			<b>SRT1-ROC16</b>
	8 MOSFET outputs	U, C, CE	<b>SRT1-ROF08</b>
			<b>SRT1-ROF16</b>
Sensor Amp Terminals	4 inputs (1 word x 4 terminals)	—	<b>SRT1-TID04S</b>
	4 inputs (4 words x 1 terminal)		<b>SRT1-TKD04S</b>
Expansion Sensor Amp Terminals	4 inputs (1 word x 4 terminals)	—	<b>SRT1-XKD04S</b>
	4 inputs (4 words x 1 terminal)		<b>SRT1-XID04S</b>
Sensor Remote Terminal Blocks	8 inputs	—	<b>SRT1-ID08S</b>
	8 outputs		<b>SRT1-OD08S</b>
	4 inputs and 4 outputs		<b>SRT1-ND08S</b>

Note: SRT1 and SRT2 can be used together in the same system at high speed setting on the SRT2's.

## NEW! 500 M Capable! Long Distance CompoBus/S Slave Modules

Item (Slave type)	Description	Standards	Part number
Transistor Remote I/O Terminal Blocks	4 transistor inputs (NPN)	U, C, CE	SRT2-ID04
	4 transistor inputs (PNP)		SRT2-ID04-1
	8 transistor inputs (NPN)		SRT2-ID08
	8 transistor inputs (PNP)		SRT2-ID08-1
	16 transistor inputs (NPN)		SRT2-ID16
	16 transistor inputs (PNP)		SRT2-ID16-1
	4 transistor outputs (NPN)		SRT2-OD04
	4 transistor outputs (PNP)		SRT2-OD04-1
	8 transistor outputs (NPN)		SRT2-OD08
	8 transistor outputs (PNP)		SRT2-OD08-1
	16 transistor outputs (NPN)		SRT2-OD16
	16 transistor outputs (PNP)		SRT2-OD16-1
Remote I/O Transistor Terminals with independent common terminals for each point	16 inputs (NPN, + common)	CE	SRT2-ID16T
	16 inputs (PNP, - common)		SRT2-ID16T-1
	16 inputs/outputs (NPN, - common)		SRT2-MD16T
	16 inputs/outputs (PNP, + common)		SRT2-MD16T-1
	16 outputs (NPN, - common)		SRT2-OD16T
	16 outputs (PNP, + common)		SRT2-OD16T-1
Remote Relay Terminals	8 relay outputs	U, C, CE	SRT2-ROC08
	16 relay outputs		SRT2-ROC16
	8 power MOSFET outputs		SRT2-ROF08
	16 power MOSFET outputs		SRT2-ROF16
Connector-Style Remote Terminal Blocks	8 transistor inputs (NPN)	U, C, CE	SRT2-VID085
	8 transistor inputs (PNP)		SRT2-VID085-1
	8 transistor outputs (NPN)		SRT2-VOD085
	8 transistor outputs (PNP)		SRT2-VOD085-1
	16 transistor inputs (NPN)		SRT2-VID16ML
	16 transistor inputs (PNP)		SRT2-VID16ML-1
	16 transistor outputs (NPN)		SRT2-VOD16ML
	16 transistor outputs (PNP)		SRT2-VODML-1
Analog Input	1 to 4 (selectable) analog inputs	U, C, CE	SRT2-AD04
Analog Output	1 or 2 (selectable) analog outputs	U, C, CE	SRT2-DA02

### Module Accessories

Item	Description	Standards	Part number
 I/O Module Cover	Cover for 10-pin terminal block	—	<b>C200H-COV11</b>
 Terminal Block Covers	Short protection for 10-pin terminal block (package of 10 covers); 8 pts	—	<b>C200H-COV02</b>
	Short protection for 19-pin terminal block (package of 10 covers); 12 pts		<b>C200H-COV03</b>
 C200H Module Connector Cover	Protective cover for unused I/O Connecting Cable connectors	—	<b>C500-COV02</b>
 CS1 Special I/O Module Connector Cover	Protective cover for unused I/O Connecting Cable connectors		<b>CV500-COV01</b>
 Relay	24 VDC, for C200H-OC221/OC222/OC223/OC224/OC225	—	<b>G6B-1174P-FD-US</b>

### Mounting Rails and Accessories

Item	Description	Standards	Part number
 Programming Console Mounting Bracket	Used to attach C200H-PRO27-E Hand-held Programming Console to a panel.	—	<b>C200H-ATT01</b>
 DIN-rail Mounting Bracket	1 set (2 included)	—	<b>C200H-DIN01</b>
 DIN Rails	Length: 50 cm; height: 7.3 cm		<b>PFP-50N</b>
	Length: 1 m; height: 7.3 cm		<b>PFP-100N</b>
	Length: 50 cm; height: 16 mm		<b>PFP-100N2</b>
 End Plate	---		<b>PFP-M</b>
 Spacer	---	<b>PFP-S</b>	
 C200HW Expansion I/O Rack Insulation Plates	Electrically insulate C200HW Expansion I/O Racks from the control panel to increase noise-resistance.	For 3-slot Rack	<b>C200HW-ATT32</b>
		For 5-slot Rack	<b>C200HW-ATT52</b>
		For 8-slot Rack	<b>C200HW-ATT82</b>
		For 10-slot Rack	<b>C200HW-ATTA2</b>

## Current Consumption Tables

The amount of current/power that can be supplied to the Modules mounted in a Rack is limited by the capacity of the Rack's Power Supply.

### Consider the Current/Power Consumption When Designing the System

- The total current consumption of the Modules must not exceed the maximum current for each voltage group.
- The total power consumption must not exceed the maximum for the Power Supply

### CPU Racks and Expansion Racks

The following table shows the maximum currents and power that can be supplied by Power Supplies on CPU Racks and Expansion Racks (both CS1 Expansion Racks and C200HW Expansion I/O Racks).

Note: 1. When calculating current/power consumption in a CPU Rack, be sure to include the power required by the CPU Rack and CPU themselves.  
2. Likewise, be sure to include the power required by the Rack itself when calculating the current/power consumption in an Expansion Rack.

Power Supply	Max. Current Capacity			Max. Total Power Consumption
	5-V group	26-V group	24-V group	
C200HW-PA204	4.6 A	0.6 A	None	30 W
C200HW-PA204S	4.6 A	0.6 A	0.8 A	30 W
C200HW-PA204R	4.6 A	0.6 A	None	30 W
C200HW-PD204	4.6 A	0.6 A	None	30 W
C200HW-PA209R	9 A	1.3 A	None	45 W

### SYSMAC BUS Slave Racks

The following table shows the maximum current and power supplied by Power Supplies in SYSMAC BUS Slave Racks.

Note: Be sure to include the power required by the Rack itself when calculating current/power consumption.

Slave Module	Max. Current Capacity			Max. Total Power Consumption
	5-V group	26-V group	24-V group	
C200H-RT201 (Wired)	2.7 A	0.6 A	0.3 A	28 W
C200H-RT202 (Wired)	2.7 A	0.6 A	None	23 W
C200H-RT001-P (Fiber-optic)	2.7 A	0.6 A	0.3 A	28 W
C200H-RT002-P (Fiber-optic)	2.7 A	0.6 A	None	23 W

Note: The current consumed by each voltage group must not exceed the maximum current shown in the table above.

### Be Sure Both Condition 1 and Condition 2 (Listed Below) Are Met

#### Condition 1: Maximum Current Supply

1. Current required at 5 VDC by all Modules (A)  $\leq$  Max. Current shown in table
2. Current required at 26 VDC by all Modules (B)  $\leq$  Max. Current shown in table
3. Current required at 24 VDC by all Modules (C)  $\leq$  Max. Current shown in table

#### Condition 2: Maximum Total Current Supply

1.  $A \times 5 \text{ VDC} + B \times 26 \text{ VDC} + C \times 24 \text{ VDC} \leq$  Max. Power shown in table

**Example Calculations**

**Example 1**

In this example, the following Modules are mounted to a CPU Rack with a C200HW-PA204S Power Supply.

Item	Part number	Quantity	5-VDC	26-VDC	24-VDC
CPU Rack (8 slots)	CS1W-BC083	1	0.11 A	—	—
CPU	CS1H-CPU67-E	1	1.10 A	—	—
Input Modules	C200H-ID216	2	0.10 A	—	—
	CS1W-ID291	2	0.20 A	—	—
Output Modules	C200H-OC221	2	0.01 A	0.075 A	—
Special I/O Modules	C200H-NC213	1	0.30 A	—	—
CS1 CPU Bus Module	CS1W-CLK21	1	0.40 A	—	—
Service Power Supply (24 VDC)		0.3 A used	—	—	0.3 A
Total current/power consumption 13.15 + 3.9 + 7.2 = 24.25 (≤30 W)			2.63 A (≤4.6) x 5 V = 13.15W	0.15 A (≤0.6A) x 26 V = 3.9 W	0.3 A (≤0.8A) x 24 V = 7.2 W

## Current Consumption Tables

### 5 VDC Voltage Group — CPUs, Communication Boards, and Racks

Item	Consumption	Part number
CPU Modules (These values include current consumption by a Programming Console or CX-Programmer.)	1.10 A	CS1H-CPU67-E(V□)
	1.10 A	CS1H-CPU66-E(V□)
	1.10 A	CS1H-CPU65-E(V□)
	1.10 A	CS1H-CPU64-E(V□)
	1.10 A	CS1H-CPU63-E(V□)
	0.95 A	CS1G-CPU45-E(V□)
	0.95 A	CS1G-CPU44-E(V□)
	0.95 A	CS1G-CPU43-E(V□)
	0.95 A	CS1G-CPU42-E(V□)
Communication Boards	0.28 A (See Note.)	CS1W-SCB21
	0.36 A (See Note.)	CS1W-SCB41
CPU Racks	0.11 A	CS1W-BC023
	0.11 A	CS1W-BC033
	0.11 A	CS1W-BC053
	0.11 A	CS1W-BC083
	0.11 A	CS1W-BC103
CS1 Racks	0.23 A	CS1W-BI023
	0.23 A	CS1W-BI033
	0.23 A	CS1W-BI053
	0.23 A	CS1W-BI083
	0.23 A	CS1W-BI103
C200H/HW Expansion I/O Racks	0.15 A	C200HW-BI031
	0.15 A	C200HW-BI051
	0.15 A	C200HW-BI081
	0.15 A	C200HW-BI101

Note: Add 0.15 A per port when the NT-AL001-E is connected.



### 5 VDC Voltage Group — Basic I/O Modules

Item	Description	Consumption (A)	Part number	
C200H Input modules	DC Input modules	0.01	C200H-ID211	
		0.01	C200H-ID212	
	AC Input Modules	0.01	C200H-IA121	
		0.01	C200H-IA122	
		0.01	C200H-IA122	
		0.01	C200H-IA221	
		0.01	C200H-IA222	
		0.01	C200H-IA222V	
	AC/DC Input Modules	0.01	C200H-IM211	
		0.01	C200H-IM212	
	B7A Interface Modules	0.10	C200H-B7AI1	
		0.10	C200H-B7AI2	
	Interrupt Input Module	0.02	C200HS-INT01	
C200H Group-2 High-density Input Modules	DC Input Modules	0.10	C200H-ID216	
		0.12	C200H-ID217	
		0.10	C200H-ID218	
		0.12	C200H-ID219	
		0.12	C200H-ID111	
CS1 High-Density Input Modules	DC Input Modules	0.20	CS1W-ID291	
C200H Output Modules	Relay Output Modules	0.01	C200H-OC221	
		0.01	C200H-OC222	
		0.008	C200H-OC222	
		0.05	C200H-OC225	
		0.03	C200H-OC226	
		0.01	C200H-OC223	
		0.01	C200H-OC224	
		0.01	C200H-OC224	
		Transistor Output Modules	0.14	C200H-OD411
			0.14	C200H-OD213
	0.14		C200H-OD214	
	0.01		C200H-OD216	
	0.16		C200H-OD211	
	0.01		C200H-OD217	
	0.18		C200H-OD212	
	0.16		C200H-OD21A	
	B7A Interface Modules	0.10	C200H-B7A01	
		0.10	C200H-B7A02	
	Triac Output Modules	0.18	C200H-OA122E	
		0.18	C200H-OA223	
0.20		C200H-OA222		
0.27		C200H-OA224		
C200H Group-2 High-density Output Modules	Transistor Output Modules	0.18	C200H-OD218	
		0.27	C200H-OD219	
CS1 High-Density Output Modules	Transistor Output Modules	0.48	CS1W-OD291	
		0.48	CS1W-OD292	
CS1 High-Density I/O Modules	DC Input/Transistor Output Modules	0.35	CS1W-MD291	
		0.35	CS1W-MD292	
C200H I/O Modules	B7A Interface Modules	0.10	C200H-B7A21	
		0.10	C200H-B7A22	
	Analog Timer Module	0.06	C200H-TM001	

## Current Consumption Tables

### 5 VDC Voltage Group — High-density I/O Modules (Special I/O Modules)

Item	Description	Consumption (A)	Part number
C200H High-density I/O Modules (Special I/O Modules)	DC Input Module	0.13	<b>C200H-ID215</b>
	TTL Input Module	0.13	<b>C200H-ID501</b>
	Transistor Output Module	0.22	<b>C200H-OD215</b>
	TTL Output Module	0.22	<b>C200H-OD501</b>
	TTL I/O Module	0.18	<b>C200H-MD501</b>
	DC Input/Transistor Output Module	0.18	<b>C200H-MD215</b>
		0.18	<b>C200H-MD115</b>

**5 VDC Voltage Group — Special I/O Modules**

Item	Description	Consumption (A)	Part number
C200H Special I/O Modules	Temperature Control Modules	0.33	C200H-TC001
		0.33	C200H-TC002
		0.33	C200H-TC003
		0.33	C200H-TC101
		0.33	C200H-TC102
		0.33	C200H-TC103
	Heat/Cool Temperature Control Modules	0.33	C200H-TV001
		0.33	C200H-TV002
		0.33	C200H-TV003
		0.33	C200H-TV101
		0.33	C200H-TV102
		0.33	C200H-TV103
	Temperature Sensor Modules	0.45	C200H-TS001
		0.45	C200H-TS002
		0.45	C200H-TS101
		0.45	C200H-TS102
	Process Control Modules	0.33	C200H-PID01
		0.33	C200H-PID02
		0.33	C200H-PID03
	Cam Positioner Module	0.30	C200H-CP114
	ASCII Modules	0.20	C200H-ASC02
		0.25	C200H-ASC11
		0.30	C200H-ASC21
		0.30	C200H-ASC31
	Analog Input Modules	0.55	C200H-AD001
		0.45	C200H-AD002
		0.10	C200H-AD003
	Analog Output Modules	0.65	C200H-DA001
		0.60	C200H-DA002
		0.10	C200H-DA003
		0.10	C200H-DA004
	Analog I/O Modules	0.10	C200H-MAD01
	High-speed Counter Modules	0.30	C200H-CT001-V1
		0.30	C200H-CT002
		0.45	C200H-CT021
	Motion Control Module	0.65 (0.85 for Teaching Box)	C200H-MC221
	Position Control Modules	0.50	C200H-NC211
		0.15	C200H-NC111
		0.15	C200H-NC112
		0.30	C200HW-NC113
		0.30	C200HW-NC213
0.50		C200HW-NC413	
Voice Module	0.30	C200HW-OV001	

(This table continues on the next page.)

## Current Consumption Tables

### 5 VDC Voltage Group — Special I/O Modules (continued)

Item	Description	Consumption (A)	Part number
C200H Special I/O Modules	RFID Controller Modules	0.25	<b>C200H-IDS01-V1</b>
		0.25	<b>C200H-IDS21</b>
	Fuzzy Logic Module	0.30	<b>C200H-FZ001</b>
	DeviceNet Master Module	0.25	<b>C200HW-DRM21-V1</b>
	DeviceNet I/O Link Module	0.25	<b>C200HW-DRT21</b>
	CompoBus/S Master Module	0.15	<b>C200HW-SRM21</b>
	PC Link Module	0.35	<b>C200H-LK401</b>
	SYSMAC BUS Remote I/O Slave Modules	0.20	<b>C200H-RM201</b>
0.20		<b>C200H-RM001-PV1</b>	

### CS1 CPU Bus Modules

Item	Description	Consumption (A)	Part number
CS1 CPU Bus Modules	Controller Link Modules	0.35	CS1W-CLK21
		0.50	CS1W-CLK11
	Serial Communications Module	0.30 (See Note.)	CS1W-SCU21
	Ethernet Module	0.40	CS1W-ETN01

Note: Add 0.15 A per port when the NT-AL001-E is connected.

### 26 VDC Modules

Item	Description	Consumption (A)	Part number
C200H Output Modules	Relay Output Modules	0.075 for 8 points ON at the same time	C200H-OC221
			C200H-OC222
			C200H-OC223
			C200H-OC224
			C200H-OC225
	Relay Output Modules	0.09 for 8 points ON at the same time	C200H-OC222V
			C200H-OC226
			C200H-OC224V
			C200H-OC227
Transistor Output Modules	0.075 for 8 points ON at the same time	C200H-OD216	
		C200H-OD217	
C200H Special I/O Modules	Analog Input Module	0.10	C200H-AD003
	Analog Output Modules	0.20	C200H-DA003
		0.25	C200H-DA004
	Analog Mixed I/O Module	0.20	C200H-MAD01
	RFID Controller Modules	0.12	C200H-IDS01-V1
0.12		C200H-IDS21	
CS1 Special I/O Modules	Analog Mixed I/O Module	0.20	CS1W-MAD44
	Analog Input Modules	0.13 A at 5 VDC 0.1 A at 26 VDC	CS1W-AD041
		0.13 A at 5 VDC 0.1 A at 26 VDC	CS1W-AD081
	Analog Output Modules	0.13 A at 5 VDC 0.18 A at 26 VDC	CS1W-DA041
		0.13 A at 5 VDC 0.18 A at 26 VDC	CS1W-DA08V
		0.13 A at 26 VDC 0.25 A at 26 VDC	CS1W-DA08C
	Motion Control Modules	0.6 A (add 0.2 A with Teach Box)	CS1W-MC221
		0.7 A (add 0.3 A with Teach Box)	CS1W-MC421



## Данный компонент на территории Российской Федерации

### Вы можете приобрести в компании MosChip.

Для оперативного оформления запроса Вам необходимо перейти по данной ссылке:

<http://moschip.ru/get-element>

Вы можете разместить у нас заказ для любого Вашего проекта, будь то серийное производство или разработка единичного прибора.

В нашем ассортименте представлены ведущие мировые производители активных и пассивных электронных компонентов.

Нашей специализацией является поставка электронной компонентной базы двойного назначения, продукции таких производителей как XILINX, Intel (ex.ALTERA), Vicor, Microchip, Texas Instruments, Analog Devices, Mini-Circuits, Amphenol, Glenair.

Сотрудничество с глобальными дистрибьюторами электронных компонентов, предоставляет возможность заказывать и получать с международных складов практически любой перечень компонентов в оптимальные для Вас сроки.

На всех этапах разработки и производства наши партнеры могут получить квалифицированную поддержку опытных инженеров.

Система менеджмента качества компании отвечает требованиям в соответствии с ГОСТ Р ИСО 9001, ГОСТ РВ 0015-002 и ЭС РД 009

### Офис по работе с юридическими лицами:

105318, г.Москва, ул.Щербаковская д.3, офис 1107, 1118, ДЦ «Щербаковский»

Телефон: +7 495 668-12-70 (многоканальный)

Факс: +7 495 668-12-70 (доб.304)

E-mail: [info@moschip.ru](mailto:info@moschip.ru)

Skype отдела продаж:

moschip.ru

moschip.ru\_4

moschip.ru\_6

moschip.ru\_9