



Pressure sensor

Gauge pressure transmitters for SMT

Series/Type:	ASR series
Ordering code:	
Date:	2011-05-02
Version:	2.2

Preliminary data sheet

Description

- Pressure sensor transmitters based on piezoresistive silicon pressure dies
- On board electronic for non-linearity and temperature error compensation
- Miniaturized SMD hybrid package (4.3 mm x 7.8mm x 3.5 mm)

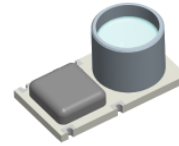

Features

- Analog ratiometric interface with adjustable output limits (clipping) or digital 14 bit I²C interface
- Diagnosis functions like loss of V_{dd}/V_{ss}, bridge connections and short cuts
- High immunity against electromagnetic influences
- Plastic free surface mount technology for reflow soldering
- Conforming to RoHS Directive

Options

- Pressure ranges up to 1.6 bar (23.2 psi)
- Other output characteristics and / or rated pressure ranges upon request

Table of Contents

1. Technical Data	3
2. Analog Output (VR/V1)	4
3. Digital Output – I ² C (D5)	5
4. Total Error (Temperature Error Multiplier)	9
5. Pressure Feed	9
6. Board Layout (Recommendation)	9
7. Reliability Testing	10
8. Product Key	11
9. Ordering Codes	11
10. Packaging.....	12
11. Reflow Soldering	13
Symbols and terms.....	14
Cautions and warnings.....	15

Preliminary data sheet
1. Technical Data
Absolute maximum ratings

Parameter	Symbol	Conditions	Min.	Max.	Unit
Temperature ranges					
Storage temperature range	T_{st}	¹⁾	-40	+125	°C
Operating temperature range	T_{op}	TN ²⁾	-40	+85	°C
		TE ²⁾	-40	+125	°C
Compensated temperature range	T_c	^{3), 4)}	0	+70	°C
Soldering temperature	T_{solder}	<10 s		260	°C
Pressure ranges					
Rated pressure range	p_r	Gauge Pressure ⁴⁾	0	see ordering codes	bar
Overpressure	p_{ov}	Gauge Pressure ⁵⁾	1.5		p_r
Burst pressure		Gauge Pressure	3		p_r
Ambient pressure		Absolute Pressure	200 (2.9)		mbar (psi)
Supply voltage /-current					
Supply voltage	V_{supply}	⁶⁾	2.7	5.5	V
Supply current	I_{supply}	$I_{out} = 0$		2.5	mA
Signal output current	I_{out}	⁷⁾		2	mA
Start up time	t_{STA}	⁸⁾		10	ms

Preliminary data sheet

2. Analog Output (VR/V1)

Parameter	Symbol	Conditions	Min.	Typ.	Max.	Unit
Analog output signal (VR/V1) @ T_{op} = 25 °C, V_{supply} = 5 V, I_{out} < 0.1 mA						
Offset (at p _{r,min})	V _{out,0}	VR: ratiometric ⁹⁾		10		%V _{CC}
		V1: 0 ... 1000 mV ⁹⁾	0	2.5		mV
Signal span (Full Scale)	V _{FS}	VR: ratiometric ¹⁰⁾		80		%V _{CC}
		V1: 0 ... 1000 mV ¹⁰⁾		1000		mV
Full scale output at p _{r,max}	V _{out,0} + V _{FS}	VR: ratiometric ^{9), 10)}		90		%V _{CC}
Diagnostic levels		enabled upon request	disabled			
Non-linearity	L	Simple output ^{10), 11)}		±0.1		% FS
Response time	t ₁₀₋₉₀	¹²⁾		2		ms
Resolution	r _{OUT}	¹³⁾		12		bit
Basic accuracy		T _{op} : 0 ... 70 °C		± 1.5	± 2	% FS

Terminal assignment

Pin Symbol	Signal
1 -	not connected
2 GND	Ground
3 V _{out}	Output signal
4 V _{supply}	Supply voltage

Dimensional drawings

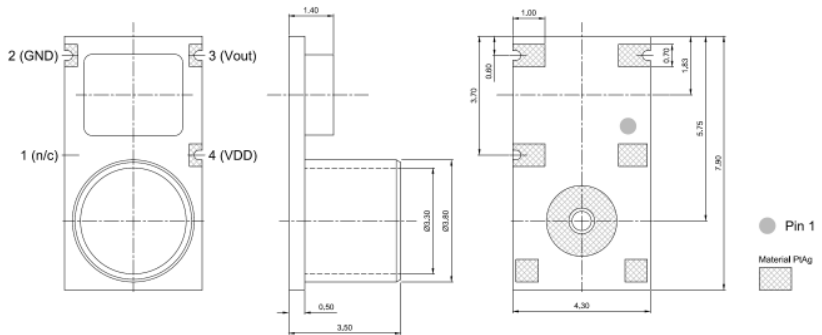

Output Characteristics

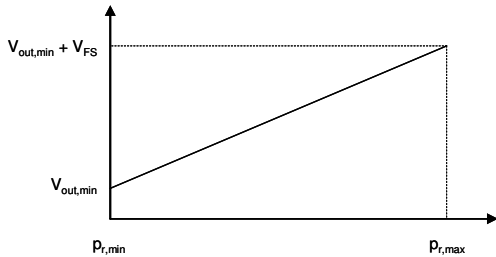

Application Circuit

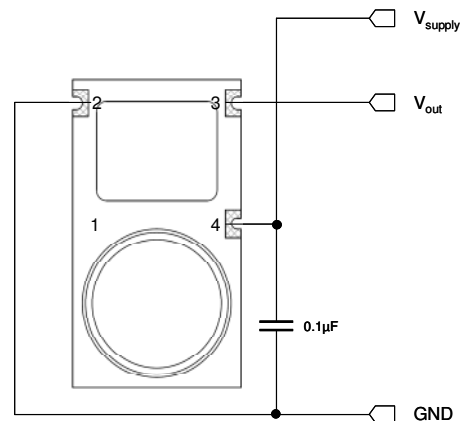

Conversion Formula

VR:
$$p_{meas} = \frac{(p_{r,max} - p_{r,min})}{V_{FS}} \cdot \left(\frac{V_{meas}}{V_{Supply}} - V_{out,min} \right) + p_{r,min}$$

V1:
$$p_{meas} = \frac{(p_{r,max} - p_{r,min})}{V_{FS}} \cdot (V_{meas} - V_{out,min}) + p_{r,min}$$

Preliminary data sheet
3. Digital Output – I²C (D5)

Parameter	Symbol	Conditions	Min.	Typ.	Max.	Unit
Digital output pressure signal (D5) @ T_{op} = 25 °C, V_{supply} = 5 V, I_{out} < 0.1 mA						
Offset (at p _{r,min})	D ^P _{out,0}	D5: I ² C - 14bit		1638		digits
Signal span (Full Scale)	D ^P _{FS}	D5: I ² C - 14bit		13107		digits
Full scale output at p _{r,max}	D ^P _{out,0} + D ^P _{FS}	D5: I ² C - 14bit		14745		digits
Non-linearity	L	Simple output ^{10), 11)}		±0.1		% FS
Response time	t ₁₀₋₉₀	¹²⁾		2		ms
Basic accuracy				± 1.5	± 2	% FS
Digital output temperature signal (D5) @ p_{r,min}, V_{supply} = 5 V, I_{out} < 0.1 mA						
Offset (at 0 °C)	D ^T _{out,0}	D5: I ² C - 11bit		512		digits
Sensitivity	D ^T _S	D5: I ² C - 11bit		10.235		digits/K
Basic accuracy		T _{op} : 0 ... 70 °C		± 2		°C

Configuration, digital interface						
System clock frequency				10 ⁶		Hz
Update period				1.5		ms
I ² C address				0x28		hex
Sensor connection check				active		
Sensor short check				active		
Sleep Mode				active		

Terminal assignment

Pin Symbol	Signal
1 GND	Ground
2 V _{supply}	Supply voltage
3 SCL	Serial Clock
4 SDA	Serial Data

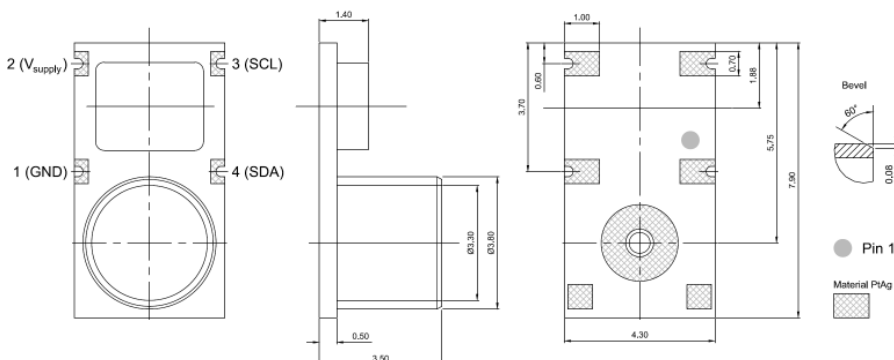
Dimensional drawings

Preliminary data sheet

Output Characteristics

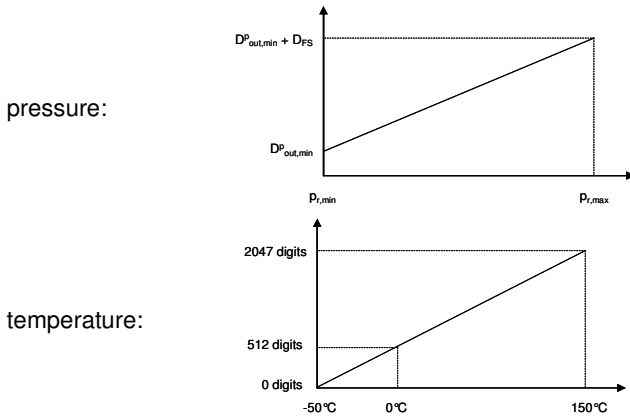

Conversion Formula

pressure:

$$p_{meas} = \frac{(p_{r,max} - p_{r,min})}{D_{FS}^p} \cdot (D_{meas}^p - D_{out,min}^p) + p_{r,min}$$

temperature:

$$T_{meas} [^{\circ}C] = \frac{D_{meas}^T - 512}{10.235}$$

Application Circuit

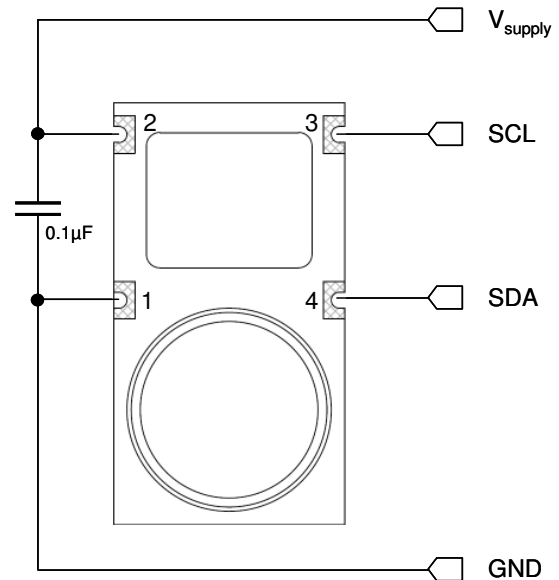

Sleep Mode

After the command window, the sensor's signal processor will power down and fall into sleep mode. To wake up the sensor's signal processor the master must send a Read_MR (measurement request operation) command or a Write_MR (reduced measurement request operation) command.

After completion of the measurement cycle the data can be transmitted via a data fetch operation and the sensor's signal processor will power down and fall into sleep mode again.

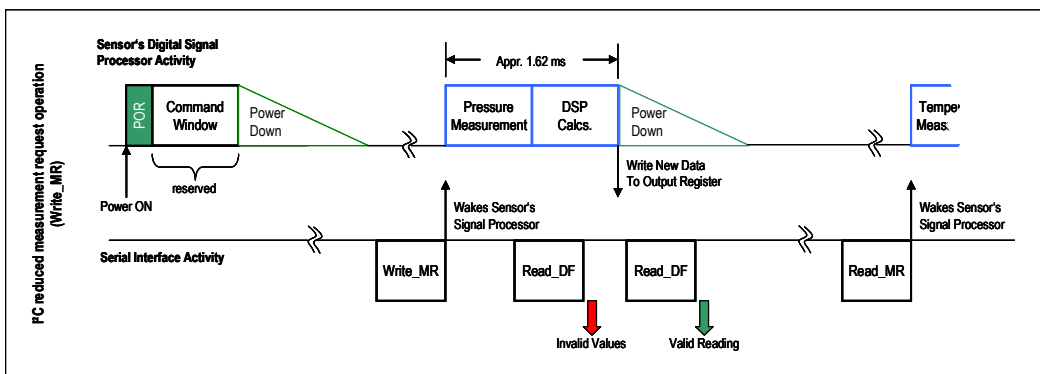
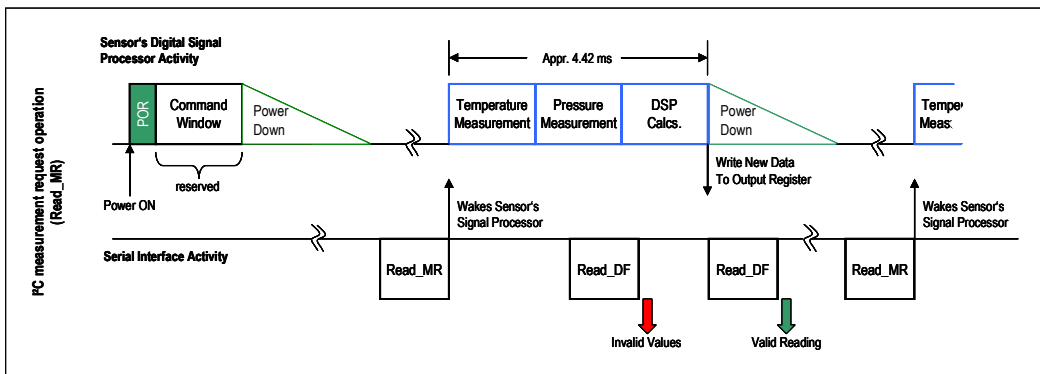

Preliminary data sheet

I²C measurement request operation (Read_MR)

The Read_MR command forces the sensor to wake up from sleep mode and to perform a complete measurement and calculation cycle. The Read_MR command is only containing the slave address and the READ bit (HIGH state) both sent by the master. After the sensor responds with the slave ACK, the master must create a stop condition.

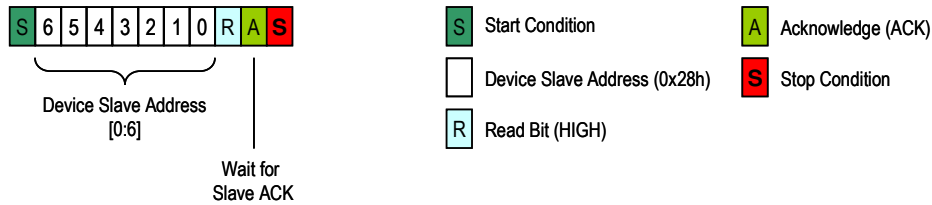

I²C reduced measurement request operation (Write_MR)

The Write_MR command forces the sensor to wake up from sleep mode and to perform only a pressure measurement and calculation cycle. (Please Note: Obsolete, maybe invalid, temperature data is used to calculate the pressure data. For using updated temperature data, please use the I²C measurement request operation – Read_MR) The Write_MR command is faster than the Read_MR command, but perhaps results are insufficient. The Write_MR command is only containing the slave address and the WRITE bit (LOW state) both sent by the master. After the sensor responds with the slave ACK, the master must create a stop condition.

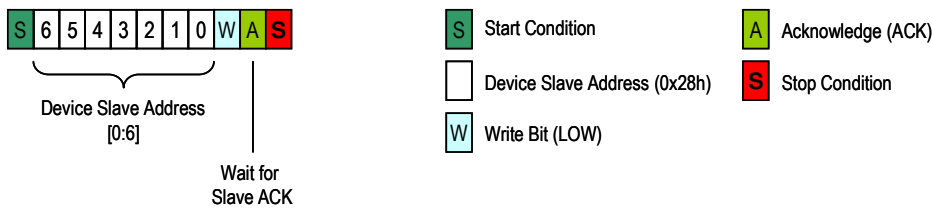

I²C data fetch operations

For data fetch operations, the I²C master must start with the 7bit slave address (0x28h) with the 8th bit high (READ request). The sensor (I²C slave node) sends an acknowledge (ACK) indicating success. The sensor sends up to 4 data bytes depending on the master's NACK.

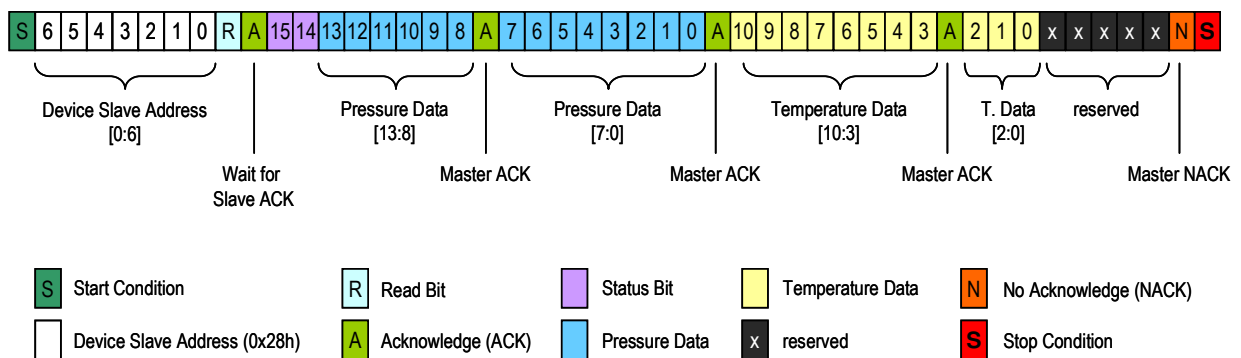

Preliminary data sheet

I²C Status Bits

The sensor offers a full suite of diagnostic features to ensure robust system operation. The diagnostic states are indicated by a transmission of the status of the 2 MSBs of the pressure high byte data.

Status Bits	Definition
00	Normal operation, good (fresh) data packet
01	Reserved
10	Stale data: Data that has already been fetched since the last measurement cycle
11	Internal error occurred

I²C data fetch example

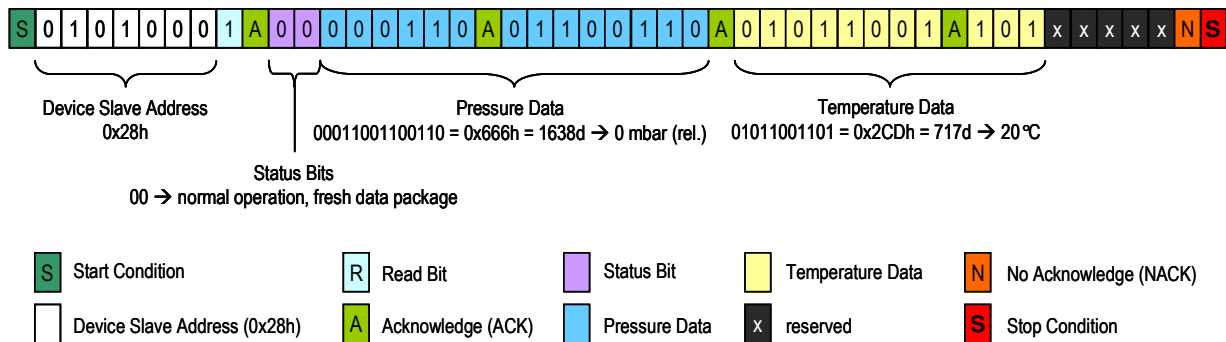

I²C protocol limitations

Please note:

- Sending a start-stop condition without any transition on the CLK line (no clock pulses in between) creates a communication error for the next communication, even if the next start condition is correct and the clock pulse is applied. An additional start condition must be sent, which results in restoration of proper communication.
- The restart condition – a falling SDA edge during data transmission when the CLK line is still high – creates the same situation. The next communication fails, and an additional start condition must be sent for correct communication.
- A falling SDA edge is not allowed between the start condition and the first rising SCL edge. If using an I²C address with the first bit 0, SDA must be held low from the start condition through the first bit.
- If a data fetch is performed before or during the first measurement after power-on reset (POR), the fetched data is invalid, even though the status bits report it as “valid” or “stale”.

Preliminary data sheet

4. Total Error (Temperature Error Multiplier)

The output accuracy over the whole temperature range can be calculated by multiplying the basic accuracy with a temperature dependant factor as shown in the following graph.

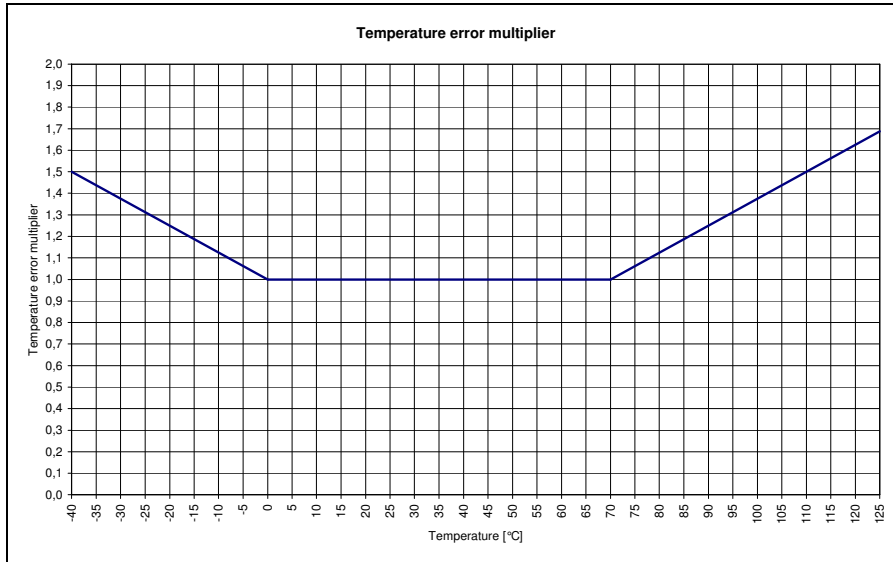

5. Pressure Feed

$$p = p_2 - p_1$$

p_1 : ambient (athmospheric) pressure

p_2 : system pressure

p : pressure corresponding to output signal

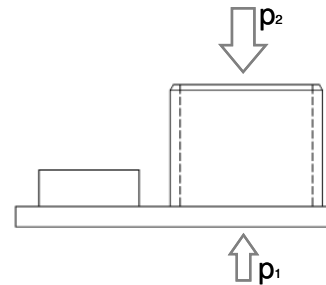

6. Board Layout (Recommendation)

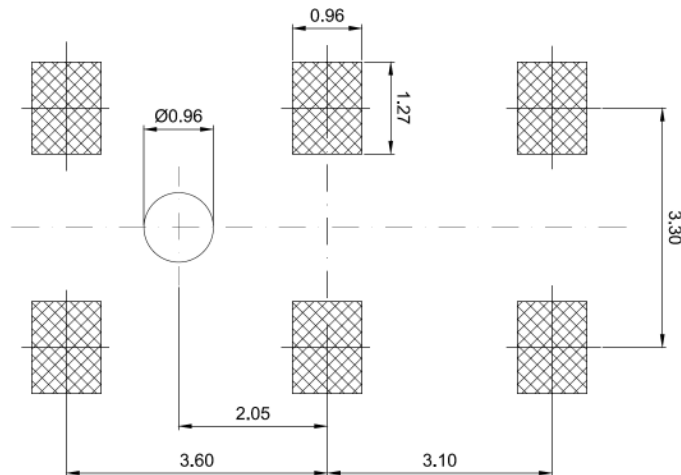

Preliminary data sheet
7. Reliability Testing
Performed Tests:

Test	Standard	Test conditions
Early Life Failure Rate (ELFR)	following to AEC-Q100-008	- Storage for 24h at +105°C
Preconditioning (PC)	following to AEC-Q100, JEDEC J-STD-020 and JEDEC JESD22-A113	- Parts from ELFR test - 5 cycles shipping conditions (-40°C to +60°C) - Bake 24h at +125°C - Soak 192h at +30°C and 60% r.h. - Apply 3 reflow soldering cycles
High Temperature Storage Life (HTSL)	following to AEC-Q100 and JEDEC JESD22-A103	- Parts from PC test - Storage for 1000h at +125°C - Unpowered
High Temperature Operating Life (HTOL)	following to AEC-Q100 and JEDEC JESD22-A108	- Parts from ELFR test - Operating for 408h at +105°C - Powered with V_{supply} at +5VDC
Variable Frequency Vibration Test (VfV)	following to AEC-Q100 and JEDEC JESD22-B103	- Parts from ELFR test - Logarithmic sweep from 20Hz to 2KHz to 20Hz within 4min - Max. acceleration at 50g - 4 x 4min in each orientation (total 144min)
Mechanical Shock Test (MS)	following to AEC-Q100 and JEDEC JESD22-B104	- Parts from ELFR test - 5 pulses with 1,500g peak acceleration in positive vertical direction - Peak duration 0.5ms
Pressure Cycle Test	(Internal standard)	- Parts from ELFR test - 1,000,000 pressure cycles between minimum rated pressure ($p_{r,min}$) and overpressure (p_{ov}) - Test performed at room temperature

Test Criterion:

All sensors have to be within the specified tolerances before and after each test listed below.

Preliminary data sheet
8. Product Key
ASR 1.600 VR TN H30 KXXXX

Customer Specific Index	Optional, reserved	
Pressure Feed	Reserved	
Operating Temperature Range	TN TE	Normal Temperature Range (-40°C ... +85°C) Extended Temperature Range (-40°C ... +125°C)
Output signal	VR V1 D5	0.1 ... 0.9 V/V (ratiometrical) 0 ... 1 V I ² C (pressure 14 bit / temperature 11 bit)
Rated pressure range	available: 0.400 bar (5.8 psi) 0.600 bar (8.7 psi) 1.000 bar (14.5 psi) 1.600 bar (23.2 psi)	
Measuring type	R	Gauge (Relative)
Sensor type	AS	Advanced Surface Mount Technology

9. Ordering Codes

Rated Pressure p _r [bar] ([psi])	Normal Temperature Range			Extended Temperature Range		
	Ratiometric	0..1000 mV	I ² C (14 bit)	Ratiometric	0..1000 mV	I ² C (14 bit)
0.400 (5.8)	n/n (ASR 0.400 VR TN H30)	n/n (ASR 0.400 V1 TN H30)	n/n (ASR 0.400 D5 TN H30)	n/n (ASR 0.400 VR TE H30)	n/n (ASR 0.400 V1 TE H30)	n/n (ASR 0.400 D5 TE H30)
0.600 (8.7)	n/n (ASR 0.600 VR TN H30)	n/n (ASR 0.600 V1 TN H30)	n/n (ASR 0.600 D5 TN H30)	n/n (ASR 0.600 VR TE H30)	n/n (ASR 0.600 V1 TE H30)	n/n (ASR 0.600 D5 TE H30)
1.000 (14.5)	n/n (ASR 1.000 VR TN H30)	n/n (ASR 1.000 V1 TN H30)	n/n (ASR 1.000 D5 TN H30)	n/n (ASR 1.000 VR TE H30)	n/n (ASR 1.000 V1 TE H30)	n/n (ASR 1.000 D5 TE H30)
1.600 (23.2)	n/n (ASR 1.600 VR TN H30)	n/n (ASR 1.600 V1 TN H30)	n/n (ASR 1.600 D5 TN H30)	n/n (ASR 1.600 VR TE H30)	n/n (ASR 1.600 V1 TE H30)	n/n (ASR 1.600 D5 TE H30)

Preliminary data sheet

10. Packaging

Tape and reel packing comply with specifications of IEC 60286-3.

Tape:

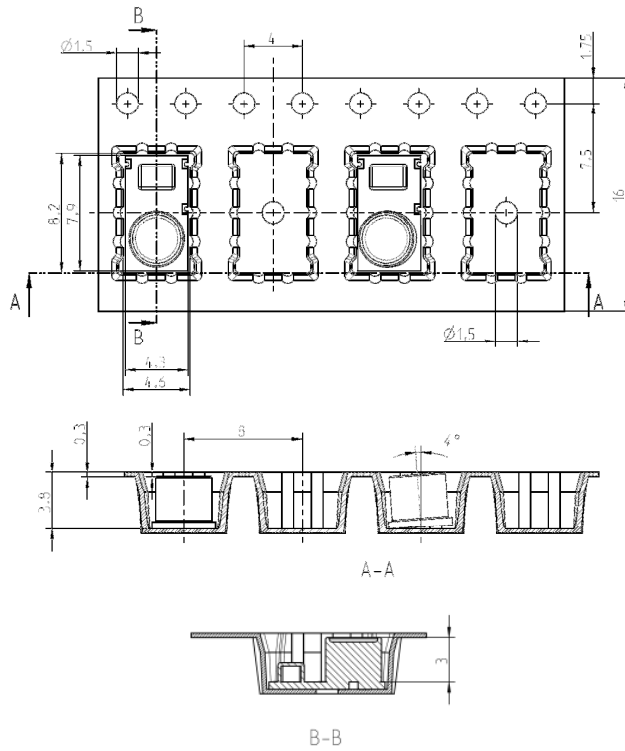

Reel: To be defined

Preliminary data sheet

11. Reflow Soldering

Recommended temperature characteristic for reflow soldering following JEDEC J-STD-020D

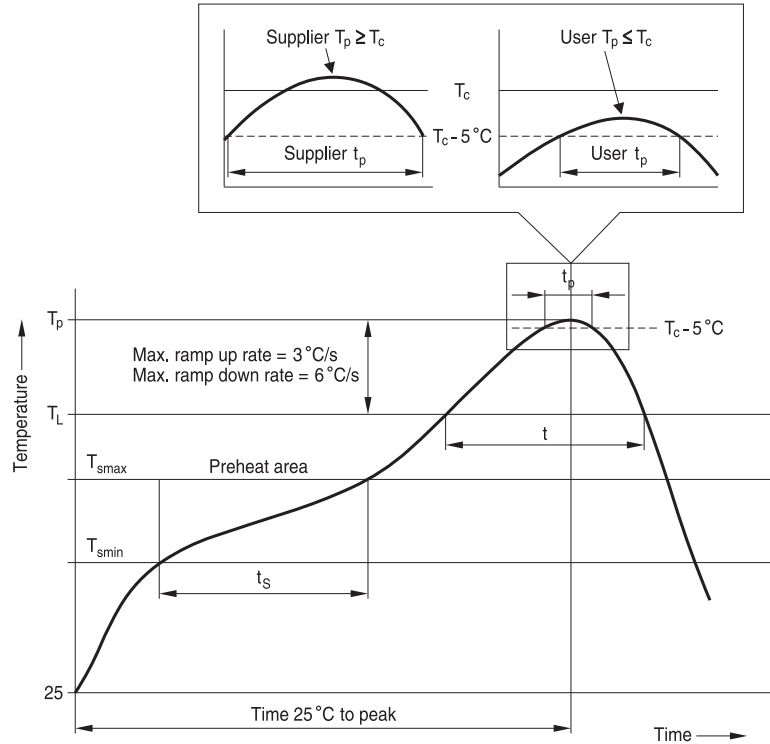

Profile feature		Sn-Pb eutectic assembly	Pb-free assembly
Preheat and soak			
- Temperature min	T_{smin}	100 °C	150 °C
- Temperature max	T_{smax}	150 °C	200 °C
- Time	t_{smin} to t_{smax}	60 ... 120 s	60 ... 180 s
Average ramp-up rate	T_{smax} to T_p	3 °C/s max.	3 °C/s max.
Liquidous temperature	T_L	183 °C	217 °C
Time at liquidous	t_L	60 ... 150 s	60 ... 150 s
Peak package body temperature	T_p ^{A)}	220 °C ... 235 °C ^{B)}	245 °C ... 260 °C ^{B)}
Time (t_p) ³⁾ within 5 °C of specified classification temperature (T_c)		20 s ^{C)}	30 s ^{C)}
Average ramp-down rate	T_p to T_{smax}	6 °C/s max.	6 °C/s max.
Time 25 °C to peak temperature		maximum 6 min	maximum 8 min

A) Tolerance for peak profile temperature (T_p) is defined as a supplier minimum and a user maximum.

B) Depending on package thickness. For details please refer to JEDEC J-STD-020D.

C) Tolerance for time at peak profile temperature (t_p) is defined as a supplier minimum and a user maximum.

Preliminary data sheet
Symbols and terms

- 1) **Storage temperature range T_{st}**
A storage of the pressure sensor within the temperature range $T_{st,min}$ up to $T_{st,max}$ and without applied pressure and supply voltage will not affect the performance of the pressure sensor.
- 2) **Operating temperature range T_{op}**
An operation of the pressure sensor within the temperature range $T_{op,min}$ up to $T_{op,max}$ will not affect the performance of the pressure sensor.
- 3) **Compensated temperature range T_c**
While operating the pressure sensor within the temperature range $T_{c,min}$ up to $T_{c,max}$, the deviation of the output signal from the values at 25 °C will not exceed the temperature coefficients. Out of the compensated temperature range, the deviations may increase.
- 4) **Rated pressure p_r**
Within the rated pressure range 0 up to $p_{r,max}$ the signal output characteristic corresponds to this specification.
- 5) **Overpressure p_{ov}**
Pressure cycles within the pressure range 0 up to p_{ov} will not affect the performance of the pressure sensor.
- 6) **Supply voltage V_{supply}**
 $V_{supply,max}$ is the maximum permissible supply voltage, which can be applied without damages.
 $V_{supply,min}$ is the minimum required supply voltage, which has to be applied for normal operation.
- 7) **Signal output current I_A**
 $I_{A,max}$ is the maximum permissible sink current of the signal output.
Exceeding (e.g. short circuit) may cause irreparable damages.
- 8) **Start up time t_{STA}**
Time between the start up of the normal operation after power on and the first valid output signal.
- 9) **Offset $V_{out,0}$**
The offset $V_{out,0}$ is the signal output $V_A(p = 0)$ at zero pressure.
- 10) **Signal span (Full Scale)**
Simple output: $V_{FS} = FS = V_{out}(p_{r,max}) - V_{A0}$
- 11) **Non-linearity L (including pressure hysteresis)**
The non-linearity is the deviation of the real sensor characteristic $V_A = f(p)$ from the ideal straight line. It can be approximated by a polynomial of second order, with the maximum at $p_x = p_r / 2$.
The equation to calculate the non-linearity is:

$$L = \frac{V_{out}(p_x) - V_{out,0} - \frac{p_x}{p_r} (V_{out}(p_r) - V_{out,0})}{V_{out}(p_r) - V_{out,0}}$$
- 12) **Response time t_{10-90}**
Delay between a pressure change (10 ... 90% p_r) and the corresponding signal output change (10 ... 90% FS).
- 13) **Resolution r_{OUT}**
The resolution of the output DAC (digital/analog converter). For ratiometric output only 80% of DAC range is used.

Preliminary data sheet

Cautions and warnings**Storage**

The pressure sensors should be stored in their original packaging. They should not be placed in harmful environments such as corrosive gases nor exposed to heat or direct sunlight, which may cause deformations. Similar effects may result from extreme storage temperatures and climatic conditions. Avoid storing the pressure sensors in an environment where condensation may form or in a location exposed to corrosive gases, which will adversely affect their performance.

Soldering

The thermal capacity of the pressure sensor is normally low, so steps should be taken to minimize the effects of external heat. High temperatures may lead to damage or changes in characteristics.

A no-clean flux should normally be used. Flux removal processes are not recommended.

Avoid rapid cooling due to dipping in solvent. Note that the output signal may change if pressure is applied to the terminals during soldering.

Operation

Media compatibility with the pressure sensors must be ensured to prevent their failure (see page 2).

The use of other media can cause damage and malfunction.

Never use them in atmospheres containing explosive liquids or gases.

Ensure pressure equalization to the environment, if relative pressure sensors are used.

Avoid operating the pressure sensors in an environment where condensation may form or in a location exposed to corrosive gases. These environments adversely affect their performance.

If the operating pressure is not within the rated pressure range, it may change the output characteristics.

Be sure that the applicable pressure does not exceed the overpressure, it may damage the pressure sensor.

Do not exceed the maximum rated supply voltage, it may damage the pressure sensor.

Do not exceed the rated storage temperature range, it may damage the pressure sensor.

Temperature variations in both the ambient conditions and the media (liquid or gas) can affect the accuracy of the output signal from the pressure sensors. Be sure to check the operating temperature range and thermal error specification of the pressure sensors to determine their suitability for the application.

Connections must be wired in accordance with the terminal assignment specified in this publication.

Care should be taken as reversed pin connections can damage the pressure sensors or degrade their performance.

Contact between the pressure sensor terminals and metals or other materials may cause errors in the output characteristics.

This listing does not claim to be complete, but merely reflects the experience of EPCOS AG.

Important notes

The following applies to all products named in this publication:

1. Some parts of this publication contain **statements about the suitability of our products for certain areas of application**. These statements are based on our knowledge of typical requirements that are often placed on our products in the areas of application concerned. We nevertheless expressly point out **that such statements cannot be regarded as binding statements about the suitability of our products for a particular customer application**. As a rule, EPCOS is either unfamiliar with individual customer applications or less familiar with them than the customers themselves. For these reasons, it is always ultimately incumbent on the customer to check and decide whether an EPCOS product with the properties described in the product specification is suitable for use in a particular customer application.
2. We also point out that **in individual cases, a malfunction of electronic components or failure before the end of their usual service life cannot be completely ruled out in the current state of the art, even if they are operated as specified**. In customer applications requiring a very high level of operational safety and especially in customer applications in which the malfunction or failure of an electronic component could endanger human life or health (e.g. in accident prevention or life-saving systems), it must therefore be ensured by means of suitable design of the customer application or other action taken by the customer (e.g. installation of protective circuitry or redundancy) that no injury or damage is sustained by third parties in the event of malfunction or failure of an electronic component.
3. **The warnings, cautions and product-specific notes must be observed.**
4. In order to satisfy certain technical requirements, **some of the products described in this publication may contain substances subject to restrictions in certain jurisdictions (e.g. because they are classed as hazardous)**. Useful information on this will be found in our Material Data Sheets on the Internet (www.epcos.com/material). Should you have any more detailed questions, please contact our sales offices.
5. We constantly strive to improve our products. Consequently, **the products described in this publication may change from time to time**. The same is true of the corresponding product specifications. Please check therefore to what extent product descriptions and specifications contained in this publication are still applicable before or when you place an order. We also **reserve the right to discontinue production and delivery of products**. Consequently, we cannot guarantee that all products named in this publication will always be available. The aforementioned does not apply in the case of individual agreements deviating from the foregoing for customer-specific products.
6. Unless otherwise agreed in individual contracts, **all orders are subject to the current version of the "General Terms of Delivery for Products and Services in the Electrical Industry" published by the German Electrical and Electronics Industry Association (ZVEI)**.
7. The trade names EPCOS, BAOKE, Alu-X, CeraDiode, CSMP, CSSP, CTVS, DSSP, MiniBlue, MKK, MLSC, MotorCap, PCC, PhaseCap, PhaseCube, PhaseMod, SIFERRIT, SIFI, SIKOREL, SilverCap, SIMDAD, SIMID, SineFormer, SIOV, SIP5D, SIP5K, ThermoFuse, WindCap are **trademarks registered or pending** in Europe and in other countries. Further information will be found on the Internet at www.epcos.com/trademarks.

Данный компонент на территории Российской Федерации

Вы можете приобрести в компании MosChip.

Для оперативного оформления запроса Вам необходимо перейти по данной ссылке:

<http://moschip.ru/get-element>

Вы можете разместить у нас заказ для любого Вашего проекта, будь то серийное производство или разработка единичного прибора.

В нашем ассортименте представлены ведущие мировые производители активных и пассивных электронных компонентов.

Нашей специализацией является поставка электронной компонентной базы двойного назначения, продукции таких производителей как XILINX, Intel (ex.ALTERA), Vicor, Microchip, Texas Instruments, Analog Devices, Mini-Circuits, Amphenol, Glenair.

Сотрудничество с глобальными дистрибьюторами электронных компонентов, предоставляет возможность заказывать и получать с международных складов практически любой перечень компонентов в оптимальные для Вас сроки.

На всех этапах разработки и производства наши партнеры могут получить квалифицированную поддержку опытных инженеров.

Система менеджмента качества компании отвечает требованиям в соответствии с ГОСТ Р ИСО 9001, ГОСТ РВ 0015-002 и ЭС РД 009

Офис по работе с юридическими лицами:

105318, г.Москва, ул.Щербаковская д.3, офис 1107, 1118, ДЦ «Щербаковский»

Телефон: +7 495 668-12-70 (многоканальный)

Факс: +7 495 668-12-70 (доб.304)

E-mail: info@moschip.ru

Skype отдела продаж:

moschip.ru

moschip.ru_4

moschip.ru_6

moschip.ru_9