

## G-SERIES SERVO SYSTEM

Save space, save wiring, save time



» Compact size

» MECHATROLINK-II

» Enhanced performance

# Compact in size big in features

*Always with your application in mind, G-Series servo drives give you additional functionalities to develop your machines faster, more flexibly and more efficiently.*

*Improved speed response, a wider range of servomotors and intuitive and fast auto-tuning belong to the new features, making it suitable for many applications, and always with the expected Omron quality and support.*

### Key features and benefits:

- Pocket-size servo with smallest footprint 15 x 4 cm
- Auto-tuning for easy and quick start-up
- Built-in MECHATROLINK-II motion bus reduces cabling and allows remote servo configuration and diagnosis
- High starting torque: 300% for 3 secs.
- Positioning, speed or torque control
- Separate power and control power supply
- Fast and accurate positioning
- Servomotor range from 50 W to 1.5 kW
- Incremental and absolute encoder available
- Cylindrical and flat servo motors up to 3,000 rpm
- Compatible with SmartStep 2 servomotors
- Vibration suppression



## Save space, save wiring, save time

From multiple cables...



to only one cable



Easy connection: single cable only!

With their built-in MECHATROLINK-II motion bus, just a single cable is needed to connect servos together. So you not only save on wiring and installation time, you also significantly reduce the chance of connection errors. Reliability is increased since the single-cable connection is much more rugged than a multiple-wiring solution.



### Fast and simple auto-tuning

The graphs show a move profile with a G-series servo in an application with an inertia ratio of 16:1. Tuning is possible via the easy to use CX-Drive, and takes just 1 minute to complete. The result is superb control, ensuring the servo and hence machine operates at its optimal point, with next to zero knowledge required from the user.

Once running, the on-board real time auto-tuning function takes care of the servo operation relative to the load inertia, again ensuring the quality of the finished produced part.

In addition, numerous suppression and notch filters are available to suppress machine vibration independent of machine direction.

Before auto-tuning



After auto-tuning



# G-Series + NCF: Optimum positioning for up to 16 axes



## Complete and compact positioning system

In a minimum of space you can have a complete and powerful PTP system when combining the CJ1W-NCF71 unit and the G-Series servo. This configuration offers 16-axis positioning with linear and circular interpolation, as well as interrupt feeding. The NCF and the G-Series offer the ideal solution for applications where space is tight.

## Full transparency from a remote host

When the G-Series is controlled by NCF positioning unit, the servo drive is fully transparent to a remote PC. This is achieved over MECHATROLINK-II from the G-Series to the PLC and over any serial or Ethernet link between the PLC and PC. Hence complying fully with Omron Smart Platform.



## PLCopen

A global standard for industrial control programming, PLCopen provides a standardized programming interface to harmonize the way people design and operate industrial control.



## NCF - key features and benefits

- 16 axes, point-to-point positioning over ML II
- System scalability with models for 2, 4 and 16 axes
- Easy, quick and reliable setup
- Optimized for positioning applications
- Simplified wiring to drives
- Integration with Omron Smart Platform



R88D-GN□/R88M-G□

# G-Series servo system

**Compact in size big in features. Save space, save wiring, save time**

- Built-in MECHATROLINK-II motion bus
- Position, speed and torque control
- High-response frequency of 1 kHz
- Real time auto-tuning
- Vibration suppression
- Separate power and control power supply
- Available motors with absolute and incremental with 17-bit encoder for greater accuracy
- Cylindrical and flat servo motors up to 3000 rpm
- Servomotors supported by SmartStep2, G-Series and G5-Series servo drives
- Peak torque 300% of continuous torque during 3 seconds or more depending on model
- IP65 and shaft oil seal available

**Ratings**

- 230 VAC single-phase 100 W to 1.5 kW (8.62 Nm)



## System configuration

### G-Series MECHATROLINK-II Servo Drive Configuration

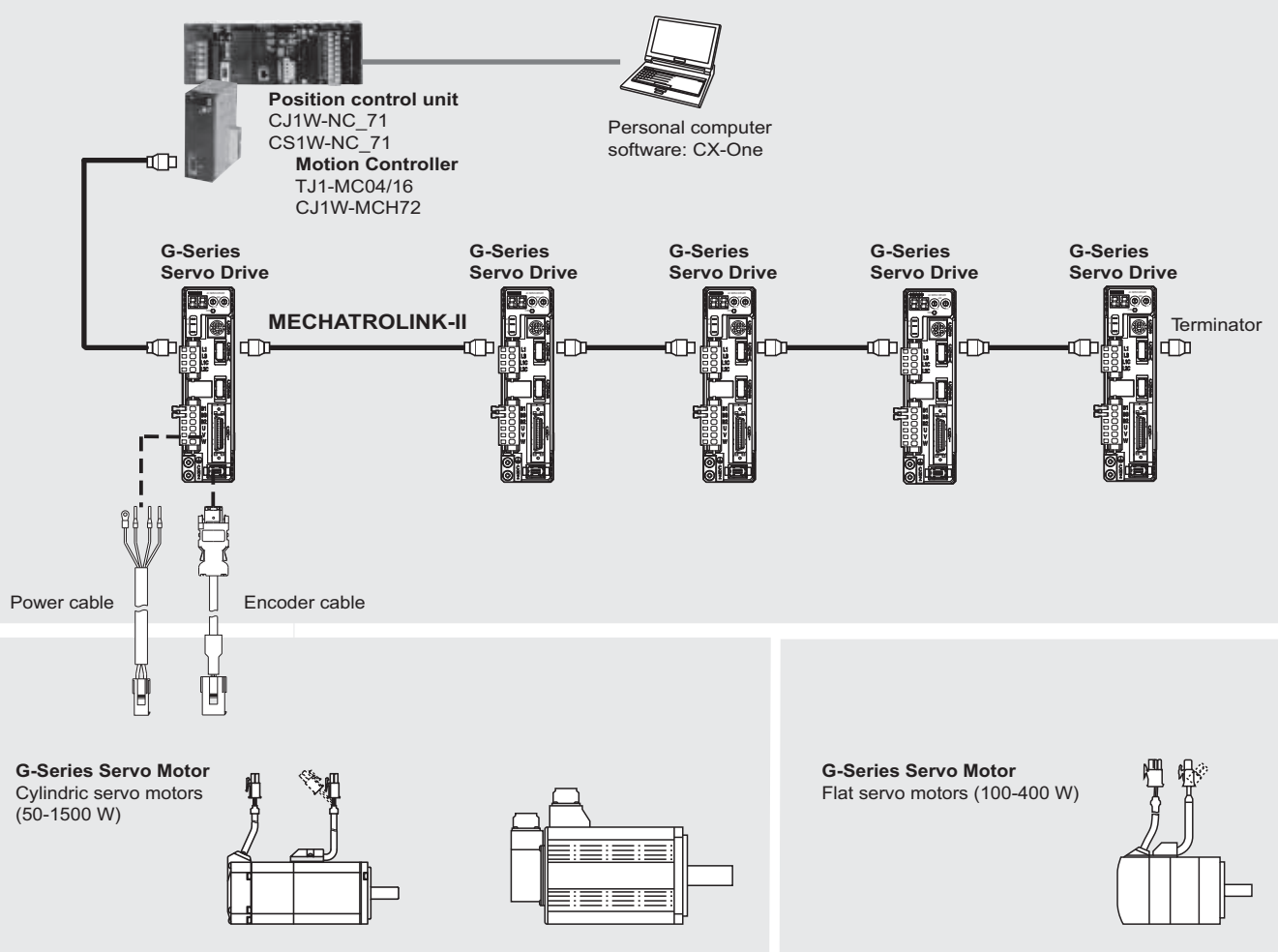

**Servo drive type designation**

Servo drive

**R88D-GN04H-ML2**

G-Series servo drive

N: Network type

Capacity

|    |        |
|----|--------|
| 01 | 100 W  |
| 02 | 200 W  |
| 04 | 400 W  |
| 08 | 750 W  |
| 10 | 1.0 kW |
| 15 | 1.5 kW |

Model

ML2: MECHATROLINK-II communications

Source voltage

H: 230 V

**Servo drive specifications**

G-Series servo drive

| Servo drive type                          |  | R88D-GN□   | 01H-ML2   | 02H-ML2 | 04H-ML2 | 08H-ML2  | 10H-ML2  | 15H-ML2                     |
|---|--|--|---|---------|---------|--|----------|-----------------------------|
| Applicable servomotor                     |  | R88M-G□  | 05030□/10030□   | 20030□  | 40030□  | 75030□   | G1K020T□ | 90010T□/1K030T□/<br>1K5□0T□ |
|   |  | R88M-GP□   | 10030□  | 20030□  | 40030□  | -  | -        | -                           |
| Max. applicable motor capacity            |  | W  | 100   | 200     | 400     | 750  | 1000     | 1500                        |
| Continuous output current                 |  | Arms   | 1.16  | 1.6     | 2.7     | 4.0  | 5.9      | 9.8                         |
| Max. output current                       |  | Arms   | 3.5   | 5.3     | 7.1     | 14.1   | 21.2     | 28.3                        |
| Input power                               |  | Main circuit   | For single-phase, 200 to 240 VAC +10 to -15% (50/60 Hz) |         |         | For single-phase/ three-phase, 200 to 240 VAC +10 to -15% (50/60 Hz) |          |                             |
| Supply                                    |  | Control circuit  | For single-phase, 200 to 240 VAC +10 to -15% (50/60 Hz) |         |         |  |          |                             |
| Control method                            |  | IGBT-driven PWM method   |   |         |         |  |          |                             |
| Feedback                                  |  | Serial encoder (incremental/absolute)  |   |         |         |  |          |                             |
| Usage/storage temperature                 |  | 0 to +55 °C / -20 to 65 °C   |   |         |         |  |          |                             |
| Usage/storage humidity                    |  | 90% RH or less (non-condensing)  |   |         |         |  |          |                             |
| Altitude                                  |  | 1000m or less above sea level  |   |         |         |  |          |                             |
| Vibration/shock resistance                |  | 5.88 m/s <sup>2</sup> / 19.6 m/s <sup>2</sup>  |   |         |         |  |          |                             |
| Configuration                             |  | Base mounted   |   |         |         |  |          |                             |
| Approx. weight                            |  | Kg   | 0.8   | 1.1     | 1.5     | 1.7  |          |                             |
| Speed control range                       |  | 1:5000   |   |         |         |  |          |                             |
| Speed variance                            |  | Load variance  | During 0 to 100% load ±0.01 max. (at rated speed)       |         |         |  |          |                             |
|   |  | Voltage variance   | 0% at ±10% of rated voltage (at rated speed)            |         |         |  |          |                             |
|   |  | Temperature variance   | 0 to 50°C ±0.1% max. (at rated speed)                   |         |         |  |          |                             |
| Frequency characteristics                 |  | 1 kHz  |   |         |         |  |          |                             |
| Torque control accuracy (reproducibility) |  | ±3% (at 20% to 100% of rated torque)   |   |         |         |  |          |                             |
| Soft start time setting                   |  | 0 to 10 s (acceleration time and deceleration time can be set)   |   |         |         |  |          |                             |
| MECHATROLINK Communication                |  | MECHATROLINK-II commands (for sequence, motion, data setting/reference, monitor, adjustment and other commands)  |   |         |         |  |          |                             |
| Sequence input signal                     |  | Emergency stop, 3 external latch signals, forward/reverse torque limit, forward/reverse run prohibit, origin proximity, 3 general-purpose inputs   |   |         |         |  |          |                             |
| Sequence output signal                    |  | It is possible to output three types of signals: positioning completed, speed coincidence, rotation speed detection, servo ready, current limit, speed limit, brake release and warning signal |   |         |         |  |          |                             |

| Servo drive type                    |                             | R88D-GN□   | 01H-ML2   | 02H-ML2 | 04H-ML2 | 08H-ML2 | 10H-ML2  | 15H-ML2                     |
|-------------------------------------|-----------------------------|--|---|---------|---------|---------|----------|-----------------------------|
| Applicable servomotor               |                             | R88M-G□  | 05030□/10030□   | 20030□  | 40030□  | 75030□  | G1K020T□ | 90010T□/1K030T□/<br>1K5□0T□ |
|                                     |                             | R88M-GP□   | 10030□  | 20030□  | 40030□  | -       | -        | -                           |
| Communications                      | RS-232 communications       | Interface  | Personal computer   |         |         |         |          |                             |
|                                     |                             | Transmission rate  | From 2400 to 57600 bps  |         |         |         |          |                             |
|                                     |                             | Functions  | Parameter setting, status display, alarm display (monitor, clear, history), servo drive data tracing function, test run/autotuning operations, real time trace, absolute encoder setting, default values function |         |         |         |          |                             |
|                                     | MECHATROLINK communications | Communications protocol  | MECHATROLINK-II   |         |         |         |          |                             |
|                                     |                             | Transmission rate  | 10 Mbps   |         |         |         |          |                             |
|                                     |                             | Data length  | 32 bytes  |         |         |         |          |                             |
|                                     | Functions                   | Parameter setting, status display, alarm display (monitor, clear, history), default values function  |   |         |         |         |          |                             |
|                                     | Integrated functions        | Automatic load inertia detection   | Horizontal and vertical axis mode. One parameter rigidity setting.  |         |         |         |          |                             |
|                                     |                             | Dynamic brake (DB)   | Operates when main power OFF, servo alarm, overtravel or servo OFF  |         |         |         |          |                             |
|                                     |                             | Regenerative processing  | Built-in regeneration resistor in models from 750 W to 1.5 kW. External regeneration resistor optionally.   |         |         |         |          |                             |
| Overtravel (OT) prevention function |                             | Dynamic brake, disables torque or emergency stop torque during POT and NOT operation   |   |         |         |         |          |                             |
| Emergency stop (STOP)               |                             | Emergency stop input   |   |         |         |         |          |                             |
| Encoder divider function            |                             | Optional division pulses possible  |   |         |         |         |          |                             |
| Electronic gearing                  |                             | 0,01<Numerator/Denominator<100   |   |         |         |         |          |                             |
| Internal speed setting function     |                             | 8 internal speeds  |   |         |         |         |          |                             |
| Protective functions                |                             | Overvoltage, undervoltage, overcurrent, overload, regeneration overload, servo drive overheat  |   |         |         |         |          |                             |
| Analog monitor Output               |                             | The actual servomotor speed, command speed, torque and number of accumulated pulses can be measured using an oscilloscope or other device. |   |         |         |         |          |                             |
| Panel operator                      |                             | Display functions  | A 2-digit 7-segment LED display shows the servo drive status, alarm codes, parameters, etc.<br>MECHATROLINK-II communications status LED indicator (COM)  |         |         |         |          |                             |
|                                     |                             | Switches   | Rotary switch for setting the MECHATROLINK-II node address  |         |         |         |          |                             |

Servo drive part names



**Dimensions**

**Servo drives**

**R88D-GN01H-ML2 / GN02H-ML2 (200 V, 100 to 200 W)**



**R88D-GN04H-ML2 (200 V, 400 W)**

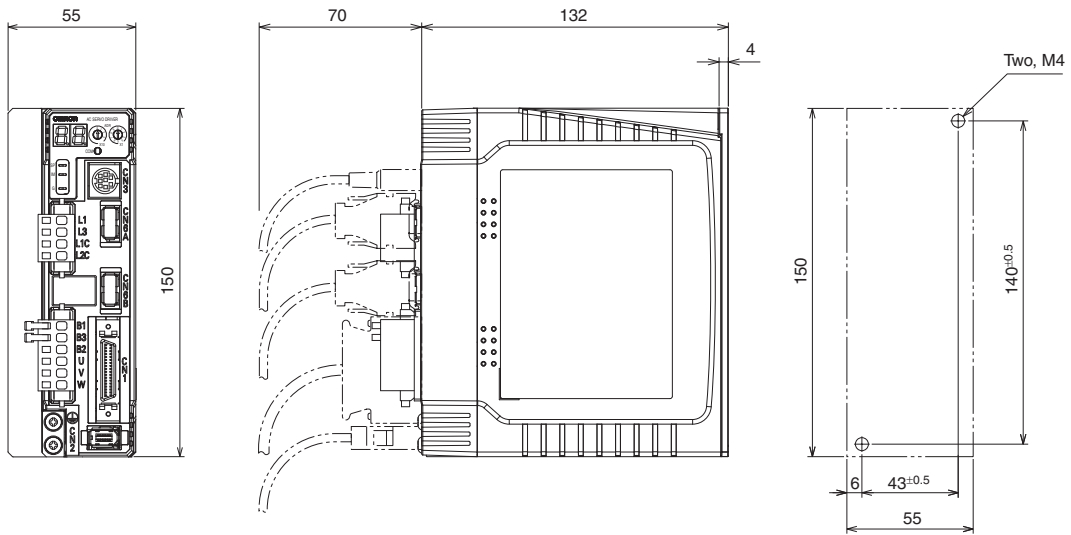

**R88D-GN08H-ML2 (200 V, 750 W)**



R88D-GN10H-ML2 / GN15H-ML2 (200 V, 1 kW to 1,5 kW )



**Servo motors type designation**

Servo motor

**R88M-GP10030H-BOS2**

G-Series Servomotor

Motor Type

- Blank: Cylinder type
- P: Flat type

Capacity

|     |        |
|-----|--------|
| 050 | 50 W   |
| 100 | 100 W  |
| 200 | 200 W  |
| 400 | 400 W  |
| 750 | 750 W  |
| 900 | 900 W  |
| 1K0 | 1 kW   |
| 1K5 | 1.5 kW |

Rated Speed (r/min)

|    |      |
|----|------|
| 10 | 1000 |
| 20 | 2000 |
| 30 | 3000 |

Shaft end specifications

|       |                       |
|-------|-----------------------|
| Blank | Straigh shaft, no key |
| S2    | Straigh, key, tapped  |

Oil seal specifications

|       |             |
|-------|-------------|
| Blank | No oil seal |
| O     | Oil seal    |

Brake specifications

|       |          |
|-------|----------|
| Blank | No brake |
| B     | Brake    |

Voltage and encoder specifications

- H: 230 V with incremental encoder
- T: 230 V with absolute encoder



**Servo motor specifications**

**Cylindrical servo motors 3000/2000/1000 r/min**

**Ratings and specifications**

| Applied voltage                       |  | 230 V   |        |        |        |        |  |         |         |         |         |
|---------------------------------------|--|---|--------|--------|--------|--------|--|---------|---------|---------|---------|
| Servo motor model R88M-□              |  | G05030  | G10030 | G20030 | G40030 | G75030 | G1K030T                                      | G1K530T | G1K020T | G1K520T | G90010T |
| Rated output                          | W                                      | 50  | 100    | 200    | 400    | 750    | 1000   | 1500    | 1000    | 1500    | 900     |
| Rated torque                          | N·m                                    | 0.16  | 0.32   | 0.64   | 1.3    | 2.4    | 3.18   | 4.77    | 4.8     | 7.15    | 8.62    |
| Instantaneous peak torque             | N·m                                    | 0.45  | 0.90   | 1.78   | 3.67   | 7.05   | 9.1  | 12.8    | 13.5    | 19.6    | 18.4    |
| Rated current                         | A (rms)                                | 1.1   |        | 1.6    | 2.6    | 4      | 7.2  | 9.4     | 5.6     | 9.4     | 7.6     |
| Instantaneous max. current            | A (rms)                                | 3.4   |        | 4.9    | 7.9    | 12.1   | 21.4   | 28.5    | 17.1    | 28.5    | 17.1    |
| Rated speed                           | min <sup>-1</sup>                      | 3000  |        |        |        |        |  |         | 2000    |         | 1000    |
| Max. speed                            | min <sup>-1</sup>                      | 5000  |        |        |        | 4500   | 5000   |         | 3000    |         | 2000    |
| Torque constant                       | N·m/A (rms)                            | 0.14  | 0.19   | 0.41   | 0.51   | 0.64   | 0.44   | 0.51    | 0.88    | 0.76    | 1.13    |
| Rotor moment of inertia (JM)          | kg·m <sup>2</sup> ×10 <sup>-4</sup>    | 0.025   | 0.051  | 0.14   | 0.26   | 0.87   | 1.69   | 2.59    | 6.17    | 11.2    |         |
| Allowable load moment of inertia (JL) | Multiple of (JM)                       | 30  |        |        |        | 20     | 15   |         | 10      |         |         |
| Rated power rate                      | kW/s                                   | 10.4  | 20.1   | 30.3   | 62.5   | 66     | 60   | 88      | 37.3    | 45.8    | 66.3    |
| Applicable Encoder                    |  | Incremental encoder (10000 pulses)  |        |        |        |        | -  |         |         |         |         |
|                                       |  | Incremental /Absolute encoder(17 bits)  |        |        |        |        |  |         |         |         |         |
| Allowable radial load                 | N                                      | 68  |        | 245    |        | 392    |  | 490     |         | 686     |         |
| Allowable thrust load                 | N                                      | 58  |        | 98     |        | 147    |  | 196     |         |         |         |
| Approx. mass                          | Kg (without brake)                     | 0.3   | 0.5    | 0.8    | 1.2    | 2.3    | 4.5  | 5.1     | 6.8     | 8.5     |         |
|                                       | Kg (with brake)                        | 0.5   | 0.7    | 1.3    | 1.7    | 3.1    | 5.1  | 6.5     | 8.7     | 10.1    | 10      |
| Brake specifications                  | Rated voltage                          | 24 VDC +/-5%  |        |        |        |        | 24 VDC +/-10%                                |         |         |         |         |
|                                       | Holding brake moment of inertia J      | 0.002   |        | 0.018  |        | 0.075  | 0.25   | 0.33    | 1.35    |         |         |
|                                       | Power consumption (at 20°C)            | 7   |        | 9      |        | 10     | 18   | 19      | 14      | 19      |         |
|                                       | Current consumption (at 20°C)          | 0.3   |        | 0.36   |        | 0.42   | 0.74   | 0.81    | 0.59    | 0.79    |         |
|                                       | Static friction torque                 | 0.29  |        | 1.27   |        | 2.45   | 4.9  | 7.8     | 4.9     | 13.7    |         |
|                                       | Rise time for holding torque           | 35  |        | 50     |        | 70     | 50   |         | 80      | 100     |         |
| Release time                          | 20                                     |   | 15     |        | 20     | 15     |  | 70      | 50      |         |         |
| Basic specifications                  | Rating                                 | Continuous  |        |        |        |        |  |         |         |         |         |
|                                       | Insulation grade                       | Type B  |        |        |        |        | Type F                                       |         |         |         |         |
|                                       | Ambient operating/ storage temperature | 0 to +40°C/ -20 to 65°C   |        |        |        |        | 0 to +40°C/ -20 to 80°C                      |         |         |         |         |
|                                       | Ambient operating/ storage humidity    | 85% RH max. (non-condensing)  |        |        |        |        |  |         |         |         |         |
|                                       | Vibration class                        | V-15  |        |        |        |        |  |         |         |         |         |
|                                       | Insulation resistance                  | 20 MΩ min. at 500 VDC between the power terminals and FG terminal                 |        |        |        |        |  |         |         |         |         |
|                                       | Enclosure                              | Totally-enclosed, self-cooling, IP65 (excluding shaft opening and lead wire ends) |        |        |        |        |  |         |         |         |         |
|                                       | Vibration resistance                   | Vibration acceleration 49 m/s <sup>2</sup>  |        |        |        |        | Vibration acceleration 24.5 m/s <sup>2</sup> |         |         |         |         |
| Mounting                              | Flange-mounted                         |   |        |        |        |        |  |         |         |         |         |

**Torque-speed characteristics**

R88M-G05030H/T (50 W)



R88M-G10030H/T (100 W)

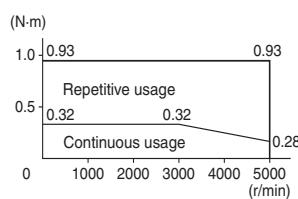

R88M-G20030H/T (200 W)



R88M-G40030H/T (400 W)

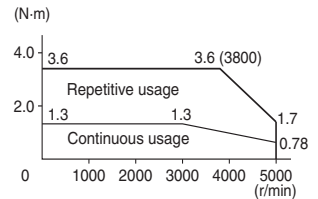

R88M-G75030H/T (750 W)



R88M-G1K030T (1 kW)

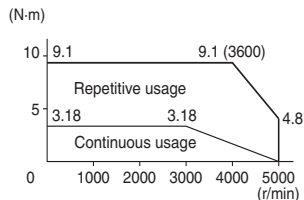

R88M-G1K530T (1.5 kW)

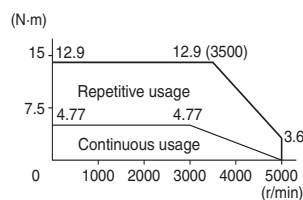

R88M-G1K020T (1 kW)

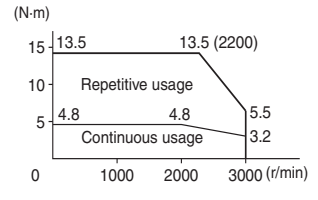

R88M-G1K520T (1.5 kW)



R88M-G90010T (900 W)

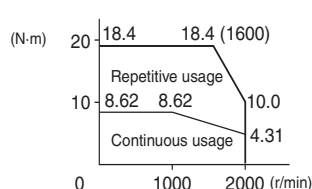

Flat servo motors 3000 r/min

Ratings and specifications

| Applied voltage                       |  | 230 V   |          |          |  |
|---------------------------------------|--|---|----------|----------|--|
| Servo motor model R88M-□              |  | GP10030□  | GP20030□ | GP40030□ |  |
| Rated output                          | W                                      | 100   | 200      | 400      |  |
| Rated torque                          | N·m                                    | 0.32  | 0.64     | 1.3      |  |
| Instantaneous peak torque             | N·m                                    | 0.86  | 1.8      | 3.65     |  |
| Rated current                         | A (rms)                                | 1   | 1.6      | 2.5      |  |
| Instantaneous max. current            | A (rms)                                | 3.1   | 4.9      | 7.5      |  |
| Rated speed                           | min <sup>-1</sup>                      | 3000  |          |          |  |
| Max. speed                            | min <sup>-1</sup>                      | 5000  |          |          |  |
| Torque constant                       | N·m/A (rms)                            | 0.34  | 0.42     | 0.54     |  |
| Rotor moment of inertia (JM)          | kg·m <sup>2</sup> ×10 <sup>-4</sup>    | 0.1   | 0.35     | 0.64     |  |
| Allowable load moment of inertia (JL) | Multiple of (JM)                       | 20  |          |          |  |
| Rated power rate                      | kW/s                                   | 10.2  | 11.5     | 25.5     |  |
| Applicable encoder                    |  | Incremental (10000 pulses)  |          |          |  |
|                                       |  | Incremental /Absolute encoder(17 bits)  |          |          |  |
| Allowable radial load                 | N                                      | 68  | 245      |          |  |
| Allowable thrust load                 | N                                      | 58  | 98       |          |  |
| Approx. mass                          | Kg (without brake)                     | 0.7   | 1.3      | 1.8      |  |
|                                       | Kg (with brake)                        | 0.9   | 2        | 2.5      |  |
| Brake specifications                  | Rated voltage                          | 24VDC +/-10%  |          |          |  |
|                                       | Holding brake moment of inertia J      | kg·m <sup>2</sup> ×10 <sup>-4</sup>   | 0.03     | 0.09     |  |
|                                       | Power consumption (at 20°C)            | W   | 7        | 10       |  |
|                                       | Current consumption (at 20°C)          | A   | 0.29     | 0.41     |  |
|                                       | Static friction torque                 | N·m (minimum)   | 0.29     | 1.27     |  |
|                                       | Rise time for holding torque           | ms (max.)   | 50       | 60       |  |
|                                       | Release time                           | ms (max)  | 15       |          |  |
| Basic specifications                  | Rating                                 | Continuous  |          |          |  |
|                                       | Insulation grade                       | Type B  |          |          |  |
|                                       | Ambient operating/ storage temperature | 0 to +40 °C/ -20 to 80°C  |          |          |  |
|                                       | Ambient operating/ storage humidity    | 85% RH max. (non-condensing)  |          |          |  |
|                                       | Vibration class                        | V-15  |          |          |  |
|                                       | Insulation resistance                  | 20 MΩ min. at 500 VDC between the power terminals and FG terminal                 |          |          |  |
|                                       | Enclosure                              | Totally-enclosed, self-cooling, IP65 (excluding shaft opening and lead wire ends) |          |          |  |
|                                       | Vibration resistance                   | Vibration acceleration 49 m/s <sup>2</sup>  |          |          |  |
| Mounting                              | Flange-mounted                         |   |          |          |  |

Torque-speed characteristics

R88M-GP10030H/T (100 W)    R88M-GP20030H/T (200 W)    R88M-GP40030H/T (400 W)



**Dimensions**

Servo motors

**Cylindrical type 3000 r/min (230 V, 50-100 W)**

| Dimensions (mm) | Without brake | With brake | LN   | Flange surface   |                 | Shaft end       |               | Aprox. Mass (Kg) |  |
|-----------------|---------------|------------|------|------------------|-----------------|-----------------|---------------|------------------|--|
|                 | LL            | LL         |      | D                | S               | B               | Without brake | With brake       |  |
| R88M-G05030□□S2 | 72            | 102        | 26.5 | 30 <sup>h7</sup> | 8 <sup>h6</sup> | 3 <sup>h9</sup> | 0.3           | 0.5              |  |
| R88M-G10030□□S2 | 92            | 122        | 46.5 |                  |                 |                 | 0.5           | 0.7              |  |



**Cylindrical type 3000 r/min (230 V, 200-750 W)**

| Dimensions (mm) | Without brake | With brake | LR | KL1 | Flange surface |                  |    |     |     | Shaft end        |      |                 |   |     | Aprox. Mass (Kg) |               |            |
|-----------------|---------------|------------|----|-----|----------------|------------------|----|-----|-----|------------------|------|-----------------|---|-----|------------------|---------------|------------|
|                 | LL            | LL         |    |     | D1             | D2               | C  | G   | Z   | S                | QK   | B               | H | T1  | Tap x depth      | Without brake | With brake |
| R88M-G20030□□S2 | 79.5          | 116        | 30 | 43  | 70             | 50 <sup>h7</sup> | 60 | 6.5 | 4.5 | 11 <sup>h6</sup> | 18   | 4 <sup>h9</sup> | 4 | 2.5 | M4x8L            | 0.8           | 1.3        |
| R88M-G40030□□S2 | 99            | 135.5      |    |     | 90             | 70 <sup>h7</sup> | 80 | 8   |     | 14 <sup>h6</sup> | 22.5 | 5 <sup>h9</sup> | 5 | 3   | M5x10L           | 1.2           | 1.7        |
| R88M-G75030□□S2 | 112.2         | 149.2      | 35 | 53  | 90             | 70 <sup>h7</sup> | 80 | 8   | 6   | 19 <sup>h6</sup> | 22   | 6 <sup>h9</sup> | 6 | 3.5 |                  | 2.3           | 3.1        |



Cylindrical type 3000, 2000 and 1000 r/min (230 V, 900 kW - 1.5 kW)

| Dimensions (mm)  | Without brake | With brake | LR | KL1 | Flange surface |                   |     |     |    |   |     |                  | Shaft end |                 |   |     |             | Aprox. Mass (Kg) |            |      |
|------------------|---------------|------------|----|-----|----------------|-------------------|-----|-----|----|---|-----|------------------|-----------|-----------------|---|-----|-------------|------------------|------------|------|
|                  |               |            |    |     | D1             | D2                | D3  | C   | G  | F | Z   | S                | QK        | B               | H | T1  | Tap x depth | Without brake    | With brake |      |
| R88M-G1K030T-□S2 | 175           | 200        | 55 | 98  | 100            | 80 <sup>h7</sup>  | 120 | 90  | 7  | 3 | 6.6 | 19 <sup>h6</sup> | 42        | 6 <sup>h9</sup> | 6 | 3.5 | M5x12L      | 4.5              | 5.1        |      |
| R88M-G1K530T-□S2 | 180           | 205        |    | 103 | 115            | 95 <sup>h7</sup>  | 135 | 100 | 10 |   | 9   |                  |           |                 |   |     |             |                  | 5.1        | 6.5  |
| R88M-G1K020T-□S2 | 150           | 175        |    | 118 | 145            | 110 <sup>h7</sup> | 165 | 130 | 12 | 6 |     | 22 <sup>h6</sup> | 41        | 8 <sup>h9</sup> | 7 | 4   |             |                  | 6.8        | 8.7  |
| R88M-G1K520T-□S2 | 175           | 200        |    |     |                |                   |     |     |    |   |     |                  |           |                 |   |     |             |                  | 8.5        | 10.1 |
| R88M-G90010T-□S2 | 175           | 200        | 70 |     |                |                   |     |     |    |   |     |                  |           |                 |   |     |             |                  | 10         |      |



Flat type 3000 r/min (230 V, 100 W - 400 W)

| Dimensions (mm)   | Without brake | With brake | LR | KL1 | Flange surface |                  |    |   |   |     |                  | Shaft end |                  |      |                 |             | Aprox. Mass (Kg) |            |     |     |
|-------------------|---------------|------------|----|-----|----------------|------------------|----|---|---|-----|------------------|-----------|------------------|------|-----------------|-------------|------------------|------------|-----|-----|
|                   |               |            |    |     | D1             | D2               | C  | F | G | Z   | S                | QK        | B                | H    | T1              | Tap x depth | Without brake    | With brake |     |     |
| R88M-GP10030H-□S2 | 60.5          | 84.5       | 25 | 43  | 70             | 50 <sup>h7</sup> | 60 | 3 | 7 | 4.5 | 8 <sup>h6</sup>  | 12.5      | 3 <sup>h9</sup>  | 3    | 1.8             | M3x6L       | 0.7              | 0.9        |     |     |
| R88M-GP10030T-□S2 | 87.5          | 111.5      |    |     |                |                  |    |   |   |     |                  |           |                  |      |                 |             |                  |            |     |     |
| R88M-GP20030H-□S2 | 67.5          | 100        | 30 | 53  | 90             | 70 <sup>h7</sup> | 80 | 5 | 8 | 5.5 | 11 <sup>h6</sup> | 18        | 4 <sup>h9</sup>  | 4    | 2.5             | M4x8L       | 1.3              | 2          |     |     |
| R88M-GP20030T-□S2 | 94.5          | 127        |    |     |                |                  |    |   |   |     |                  |           |                  |      |                 |             |                  |            |     |     |
| R88M-GP40030H-□S2 | 82.5          | 115        |    |     |                |                  |    |   |   |     |                  |           | 14 <sup>h6</sup> | 22.5 | 5 <sup>h9</sup> | 5           | 3.0              | M5x10L     | 1.8 | 2.5 |
| R88M-GP40030T-□S2 | 109.5         | 142        |    |     |                |                  |    |   |   |     |                  |           |                  |      |                 |             |                  |            |     |     |



Installation

Single-phase, 230 VAC



\*1 Connect when using an absolute encoder. If a backup battery is connected, an encoder cable with a battery is not required.  
 \*2 Connect B2-B3 for the models with a built-in regeneration resistor (models from 750 W).  
 \*3 If the amount of regeneration is large, connect an external regeneration resistor to B1-B2. For the models from 750 W, disconnect B2-B3.

Ordering information



Note: The symbols ①②③④⑤... show the recommended sequence to select the components in a G-Series servo system

Servo drives

| Symbol | Specifications  |       | Servo drive model | ① Compatible rotary servo motors |               |
|--------|-----------------|-------|-------------------|----------------------------------|---------------|
|        |                 |       |                   | Cylindric type                   | Flat type     |
| ②      | 1 phase 200 VAC | 100 W | R88D-GN01H-ML2    | R88M-G05030□                     | R88M-GP10030□ |
|        |                 |       | R88M-G10030□      |                                  |               |
|        |                 |       | R88D-GN02H-ML2    | R88M-G20030□                     | R88M-GP20030□ |
|        |                 |       | R88D-GN04H-ML2    | R88M-G40030□                     | R88M-GP40030□ |
|        |                 |       | R88D-GN08H-ML2    | R88M-G75030□                     | -             |
|        |                 |       | R88D-GN10H-ML2    | R88M-G1K020T□                    | -             |
|        |                 |       | R88D-GN15H-ML2    | R88M-G90010T□                    | -             |
|        |                 |       | R88M-G1K030T□     | -                                |               |
|        |                 |       | R88M-G1K520T□     | -                                |               |
|        |                 |       | R88M-G1K530T□     | -                                |               |

Control cables (for CN1)

| Symbol | Name                 | Connect to              | Model       |               |
|--------|----------------------|-------------------------|-------------|---------------|
| ⑥      | I/O connector kit    | Servo drive I/O signals | R88A-CNU01C |               |
| ⑦      | Terminal block cable |                         | 1 m         | XW2Z-100J-B33 |
|        |                      |                         | 2 m         | XW2Z-200J-B33 |
| ⑧      | Terminal block       | -                       | XW2B-20G4   |               |
|        |                      |                         | XW2B-20G5   |               |
|        |                      |                         | XW2D-20G6   |               |

Computer cable (for CN3)

| Symbol | Name                 | Model             |
|--------|----------------------|-------------------|
| ⑨      | Computer cable RS232 | 2 m R88A-CCG002P2 |

MECHATROLINK-II cables (for CN6)

| Symbol | Specifications                      | Length                 | Model            |
|--------|-------------------------------------|------------------------|------------------|
| ⑪      | MECHATROLINK-II Terminator resistor | -                      | JEPMC-W6022-E    |
|        |                                     | MECHATROLINK-II cables | 0.5 m            |
|        |                                     | 1 m                    | JEPMC-W6003-01-E |
|        |                                     | 3 m                    | JEPMC-W6003-03-E |
|        |                                     | 5 m                    | JEPMC-W6003-05-E |
|        |                                     | 10 m                   | JEPMC-W6003-10-E |
|        |                                     | 20 m                   | JEPMC-W6003-20-E |
|        |                                     | 30 m                   | JEPMC-W6003-30-E |

Footprint filters

| Symbol | Applicable servodrive | Filter model   | Rated current | Leakage current | Rated voltage        |
|--------|-----------------------|----------------|---------------|-----------------|----------------------|
| ⑫      | R88D-GN01H□           | R88A-FIK102-RE | 2.4 A         | 3.5 mA          | 250 VAC single-phase |
|        | R88D-GN02H□           |                |               |                 |                      |
|        | R88D-GN04H□           | R88A-FIK104-RE | 4.1 A         | 3.5 mA          |                      |
|        | R88D-GN08H□           |                |               |                 |                      |
|        | R88D-GN10H□           | R88A-FIK114-RE | 14.2 A        | 3.5 mA          |                      |
|        | R88D-GN15H□           |                |               |                 |                      |

External regenerative resistor

| Symbol | Regenerative resistor unit model | Specifications |
|--------|----------------------------------|----------------|
| ⑬      | R88A-RR08050S                    | 50 Ω, 80 W     |
|        | R88A-RR080100S                   | 100 Ω, 80 W    |
|        | R88A-RR22047S                    | 47 Ω, 220 W    |
|        | R88A-RR50020S                    | 20 Ω, 500 W    |

MECHATROLINK-II Motion controllers

| Symbol | Name                                   | Model                |
|--------|--|----------------------|
| ⑩      | Trajexia stand-alone motion controller | TJ1-MC04 (4 axes)    |
|        |  | TJ1-MC16 (16 axes)   |
|        | Trajexia-PLC motion controller         | CJ1W-MCH72           |
|        | Position Controller Unit for CJ1 PLC   | CJ1W-NCF71 (16 axes) |
|        |  | CJ1W-NC471 (4 axes)  |
|        |  | CJ1W-NC271 (2 axes)  |
|        | Position Controller Unit for CS1 PLC   | CS1W-NCF71 (16 axes) |
|        |  | CS1W-NC471 (4 axes)  |
|        |  | CS1W-NC271 (2 axes)  |

Computer software

| Specifications   | Model    |
|--|----------|
| Configuration and monitoring software tool for servo drives and inverters. (CX-drive version 1.70 or higher) | CX-drive |
| Complete OMRON software package including CX-drive. (CX-One version 3.10 or higher)                          | CX-One   |

Cylindrical servo motors 3000/2000/1000 r/min (50 - 1.5 kW)

| Symbol   | Specifications |  |                        |                        |                 |                  | Servo motor model | Compatible servo drives (2) |                |
|--|----------------|--|------------------------|------------------------|-----------------|------------------|-------------------|-----------------------------|----------------|
|  | Voltage        | Encoder and design   | Speed                  | Design                 | Rated torque    | Capacity         |                   |                             |                |
| <br>(50-750 W)<br><br><br>(900-1500 W) | 230 V          | Incremental encoder (10000 pulses)<br><br>Straight shaft with key & tap      | 3000 min <sup>-1</sup> | Without brake          | 0.16 Nm         | 50 W             | R88M-G05030H-S2   | R88D-GN01H-ML2              |                |
|  |                |  |                        |                        | 0.32 Nm         | 100 W            | R88M-G10030H-S2   | R88D-GN01H-ML2              |                |
|  |                |  |                        |                        | 0.64 Nm         | 200 W            | R88M-G20030H-S2   | R88D-GN02H-ML2              |                |
|  |                |  |                        |                        | 1.3 Nm          | 400 W            | R88M-G40030H-S2   | R88D-GN04H-ML2              |                |
|  |                |  |                        |                        | 2.4 Nm          | 750 W            | R88M-G75030H-S2   | R88D-GN08H-ML2              |                |
|  |                |  |                        |                        | 2.4 Nm          | 750 W            | R88M-G75030H-BS2  | R88D-GN08H-ML2              |                |
|  |                |  |                        | With brake             | 0.16 Nm         | 50 W             | R88M-G05030H-BS2  | R88D-GN01H-ML2              |                |
|  |                |  |                        |                        | 0.32 Nm         | 100 W            | R88M-G10030H-BS2  | R88D-GN01H-ML2              |                |
|  |                |  |                        |                        | 0.64 Nm         | 200 W            | R88M-G20030H-BS2  | R88D-GN02H-ML2              |                |
|  |                |  |                        |                        | 1.3 Nm          | 400 W            | R88M-G40030H-BS2  | R88D-GN04H-ML2              |                |
|  |                |  |                        |                        | 2.4 Nm          | 750 W            | R88M-G75030H-BS2  | R88D-GN08H-ML2              |                |
|  |                |  |                        |                        | 2.4 Nm          | 750 W            | R88M-G75030H-BS2  | R88D-GN08H-ML2              |                |
|  |                | Absolute/ incremental encoder (17 bits)<br><br>Straight shaft with key & tap | Without brake          | 0.16 Nm                | 50 W            | R88M-G05030T-S2  | R88D-GN01H-ML2    |                             |                |
|  |                |  |                        | 0.32 Nm                | 100 W           | R88M-G10030T-S2  | R88D-GN01H-ML2    |                             |                |
|  |                |  |                        | 0.64 Nm                | 200 W           | R88M-G20030T-S2  | R88D-GN02H-ML2    |                             |                |
|  |                |  |                        | 1.3 Nm                 | 400 W           | R88M-G40030T-S2  | R88D-GN04H-ML2    |                             |                |
|  |                |  |                        | 2.4 Nm                 | 750 W           | R88M-G75030T-S2  | R88D-GN08H-ML2    |                             |                |
|  |                |  |                        | 3.18 Nm                | 1 kW            | R88M-G1K030T-S2  | R88D-GN15H-ML2    |                             |                |
|  |                |  | With brake             | 4.77 Nm                | 1.5 kW          | R88M-G1K530T-S2  | R88D-GN15H-ML2    |                             |                |
|  |                |  |                        | 0.16 Nm                | 50 W            | R88M-G05030T-BS2 | R88D-GN01H-ML2    |                             |                |
|  |                |  |                        | 0.32 Nm                | 100 W           | R88M-G10030T-BS2 | R88D-GN01H-ML2    |                             |                |
|  |                |  |                        | 0.64 Nm                | 200 W           | R88M-G20030T-BS2 | R88D-GN02H-ML2    |                             |                |
|  |                |  |                        | 1.3 Nm                 | 400 W           | R88M-G40030T-BS2 | R88D-GN04H-ML2    |                             |                |
|  |                |  |                        | 2.4 Nm                 | 750 W           | R88M-G75030T-BS2 | R88D-GN08H-ML2    |                             |                |
| 2000 min <sup>-1</sup>   | Without brake  | 3000 min <sup>-1</sup>   | 4.8 Nm                 | 1 kW                   | R88M-G1K020T-S2 | R88D-GN10H-ML2   |                   |                             |                |
|  |                |  | 7.15 Nm                | 1.5 kW                 | R88M-G1K520T-S2 | R88D-GN15H-ML2   |                   |                             |                |
|  |                |  | With brake             | 4.8 Nm                 | 1 kW            | R88M-G1K020T-BS2 | R88D-GN10H-ML2    |                             |                |
|  |                |  |                        | 7.15 Nm                | 1.5 kW          | R88M-G1K520T-BS2 | R88D-GN15H-ML2    |                             |                |
|  |                |  |                        | 1000 min <sup>-1</sup> | Without brake   | 8.62 Nm          | 900 W             | R88M-G90010T-S2             | R88D-GN15H-ML2 |
|  |                |  |                        |                        |                 | 8.62 Nm          | 900 W             | R88M-G90010T-BS2            | R88D-GN15H-ML2 |

Flat type servo motors 3000 r/min (100 - 400 W)

| Symbol  | Specifications |  |               |               | Servo motor model | Compatible servo drives (2) |                   |                |
|---|----------------|--|---------------|---------------|-------------------|-----------------------------|-------------------|----------------|
|   | Voltage        | Encoder and design   | Rated torque  | Capacity      |                   |                             |                   |                |
|  | 230 V          | Incremental encoder (10000 pulses)<br><br>Straight shaft with key & tap      | 3000 r/min    | Without brake | 0.32 Nm           | 100 W                       | R88M-GP10030H-S2  | R88D-GN01H-ML2 |
|   |                |  |               |               | 0.64 Nm           | 200 W                       | R88M-GP20030H-S2  | R88D-GN02H-ML2 |
|   |                |  |               |               | 1.3 Nm            | 400 W                       | R88M-GP40030H-S2  | R88D-GN04H-ML2 |
|   |                |  |               | With brake    | 0.32 Nm           | 100 W                       | R88M-GP10030H-BS2 | R88D-GN01H-ML2 |
|   |                |  |               |               | 0.64 Nm           | 200 W                       | R88M-GP20030H-BS2 | R88D-GN02H-ML2 |
|   |                |  |               |               | 1.3 Nm            | 400 W                       | R88M-GP40030H-BS2 | R88D-GN04H-ML2 |
|   |                | Absolute/ incremental encoder (17 bits)<br><br>Straight shaft with key & tap | Without brake | 0.32 Nm       | 100 W             | R88M-GP10030T-S2            | R88D-GN01H-ML2    |                |
|   |                |  |               | 0.64 Nm       | 200 W             | R88M-GP20030T-S2            | R88D-GN02H-ML2    |                |
|   |                |  |               | 1.3 Nm        | 400 W             | R88M-GP40030T-S2            | R88D-GN04H-ML2    |                |
|   |                |  | With brake    | 0.32 Nm       | 100 W             | R88M-GP10030T-BS2           | R88D-GN01H-ML2    |                |
|   |                |  |               | 0.64 Nm       | 200 W             | R88M-GP20030T-BS2           | R88D-GN02H-ML2    |                |
|   |                |  |               | 1.3 Nm        | 400 W             | R88M-GP40030T-BS2           | R88D-GN04H-ML2    |                |

Encoder Cables

| Symbol | Specifications  | Model | Appearance         |   |
|--------|---|-------|--------------------|---|
| ③      | Encoder cable for absolute encoder (50-750 W)<br>R88M-G(050/100/200/400/750)30T-□<br>R88M-GP(100/200/400)30T-□    | 1.5 m | R88A-CRGA001-5CR-E |  |
|        |   | 3 m   | R88A-CRGA003CR-E   |   |
|        |   | 5 m   | R88A-CRGA005CR-E   |   |
|        |   | 10 m  | R88A-CRGA010CR-E   |   |
|        |   | 15 m  | R88A-CRGA015CR-E   |   |
|        |   | 20 m  | R88A-CRGA020CR-E   |   |
|        | Encoder cable for Incremental encoder (50-750 W)<br>R88M-G(050/100/200/400/750)30H-□<br>R88M-GP(100/200/400)30H-□ | 1.5 m | R88A-CRGB001-5CR-E |  |
|        |   | 3 m   | R88A-CRGB003CR-E   |   |
|        |   | 5 m   | R88A-CRGB005CR-E   |   |
|        |   | 10 m  | R88A-CRGB010CR-E   |   |
|        |   | 15 m  | R88A-CRGB015CR-E   |   |
|        |   | 20 m  | R88A-CRGB020CR-E   |   |
|        | Encoder cable for Absolute encoder (900-1500 W)<br>R88M-G(1K0/1K5)30T-□<br>R88M-G(1K0/1K5)20T-□<br>R88M-G90010T-□ | 1.5 m | R88A-CRGC001-5NR-E |  |
|        |   | 3 m   | R88A-CRGC003NR-E   |   |
|        |   | 5 m   | R88A-CRGC005NR-E   |   |
|        |   | 10 m  | R88A-CRGC010NR-E   |   |
|        |   | 15 m  | R88A-CRGC015NR-E   |   |
|        |   | 20 m  | R88A-CRGC020NR-E   |   |

**Absolute Encoder Battery cable**

| Symbol | Specifications   | Model                               | Appearance       |
|--------|--|-------------------------------------|------------------|
| ③      | Absolute Encoder battery cable<br>Battery not included | 0.3 m                               | R88A-CRGD0R3C    |
|        |  | One R88A-BAT01G<br>Battery included | R88A-CRGD0R3C-BS |
|        | Absolute Encoder backup battery<br>2,000 mA.h 3.6V     | -                                   | R88A-BAT01G      |

**Note:** The absolute encoder battery cable is only an extension and must be used with an absolute encoder cable.

**Power cables**

| Symbol | Specifications   | Model            | Appearance         |   |
|--------|--|------------------|--------------------|---|
| ④      | For servomotors from 50 to 750W<br>R88M-G(050/100/200/400/750)30□<br>R88M-GP(100/200/400)30□<br><br>For servomotors with brake, a separate cable<br>(R88A-CAGA□BR-E) is needed | 1.5 m            | R88A-CAGA001-5SR-E |   |
|        |  | 3 m              | R88A-CAGA003SR-E   |   |
|        |  | 5 m              | R88A-CAGA005SR-E   |   |
|        |  | 10 m             | R88A-CAGA010SR-E   |   |
|        |  | 15 m             | R88A-CAGA015SR-E   |   |
|        |  | 20 m             | R88A-CAGA020SR-E   |   |
|        | For servomotors from 900 to 1.5 kW without brake<br>R88M-G(1K0/1K5)30T-S2<br>R88M-G(1K0/1K5)20T-S2<br>R88M-G90010T-S2  | 1.5 m            | R88A-CAGB001-5SR-E |   |
|        |  | 3 m              | R88A-CAGB003SR-E   |   |
|        |  | 5 m              | R88A-CAGB005SR-E   |   |
|        |  | 10 m             | R88A-CAGB010SR-E   |   |
|        |  | 15 m             | R88A-CAGB015SR-E   |   |
|        | For servomotors from 900 to 1.5 kW with brake<br>R88M-G(1K0/1K5)30T-BS2<br>R88M-G(1K0/1K5)20T-BS2<br>R88M-G90010T-BS2  | 1.5 m            | R88A-CAGB001-5BR-E |  |
|        |  | 3 m              | R88A-CAGB003BR-E   |   |
|        |  | 5 m              | R88A-CAGB005BR-E   |   |
|        |  | 10 m             | R88A-CAGB010BR-E   |   |
| 15 m   |  | R88A-CAGB015BR-E |                    |   |
| 20 m   | R88A-CAGB020BR-E   |                  |                    |   |

**Brake cable (for 50-750W servomotors)**

| Symbol | Specifications  | Model | Appearance         |  |
|--------|---|-------|--------------------|--|
| ⑤      | Brake cable only.<br>For servomotors from 50 to 750W with brake<br><br>R88M-G(050/100/200/400/750)30□-BS2,<br>R88M-GP(100/200/400)30□-BS2 | 1.5 m | R88A-CAGA001-5BR-E |  |
|        |   | 3 m   | R88A-CAGA003BR-E   |  |
|        |   | 5 m   | R88A-CAGA005BR-E   |  |
|        |   | 10 m  | R88A-CAGA010BR-E   |  |
|        |   | 15 m  | R88A-CAGA015BR-E   |  |
|        |   | 20 m  | R88A-CAGA020BR-E   |  |

**Connectors for power, encoder and brake cables**

| Specifications                | Applicable Servomotor | Model   |               |
|-------------------------------|-----------------------|---|---------------|
| Connectors for power cables   | Motor side            | R88M-G(050/100/200/400/750)30□, R88M-GP(100/200/400)30□                           | R88A-CNG01A   |
|                               | Motor side            | R88M-G(1K0/1K5)30□-S2, R88M-G(1K0/1K5)20□-S2, R88M-G90010□-S2 (without brake)     | MS3108E20-4S  |
|                               | Motor side            | R88M-G(1K0/1K5)30□-BS2, R88M-G(1K0/1K5)20□-BS2, R88M-G90010□-BS2 (with brake)     | MS3108E20-18S |
| Connectors for encoder cables | Drive side (CN2)      | -   | R88A-CNW01R   |
|                               | Motor side            | R88M-G(050/100/200/400/750)30T-□, R88M-GP(100/200/400)30T-□ (Absolute encoder)    | R88A-CNG01R   |
|                               | Motor side            | R88M-G(050/100/200/400/750)30H-□, R88M-GP(100/200/400)30H-□ (Incremental encoder) | R88A-CNG02R   |
|                               | Motor side            | R88M-G(1K0/1K5)30T-□, R88M-G(1K0/1K5)20T-□, R88M-G90010T-□                        | MS3108E20-29S |
| Connector for brake cable     | Motor side            | R88M-G(050/100/200/400/750)30□-BS2, R88M-GP(100/200/400)30□-BS2                   | R88A-CNG01B   |

ALL DIMENSIONS SHOWN ARE IN MILLIMETERS.  
To convert millimeters into inches, multiply by 0.03937. To convert grams into ounces, multiply by 0.03527.

In the interest of product improvement, specifications are subject to change without notice.



**Austria**

Tel: +43 (0) 2236 377 800  
[www.industrial.omron.at](http://www.industrial.omron.at)

**Belgium**

Tel: +32 (0) 2 466 24 80  
[www.industrial.omron.be](http://www.industrial.omron.be)

**Czech Republic**

Tel: +420 234 602 602  
[www.industrial.omron.cz](http://www.industrial.omron.cz)

**Denmark**

Tel: +45 43 44 00 11  
[www.industrial.omron.dk](http://www.industrial.omron.dk)

**Finland**

Tel: +358 (0) 207 464 200  
[www.industrial.omron.fi](http://www.industrial.omron.fi)

**France**

Tel: +33 (0) 1 56 63 70 00  
[www.industrial.omron.fr](http://www.industrial.omron.fr)

**Germany**

Tel: +49 (0) 2173 680 00  
[www.industrial.omron.de](http://www.industrial.omron.de)

**Hungary**

Tel: +36 1 399 30 50  
[www.industrial.omron.hu](http://www.industrial.omron.hu)

**Italy**

Tel: +39 02 326 81  
[www.industrial.omron.it](http://www.industrial.omron.it)

**Netherlands**

Tel: +31 (0) 23 568 11 00  
[www.industrial.omron.nl](http://www.industrial.omron.nl)

**Norway**

Tel: +47 (0) 22 65 75 00  
[www.industrial.omron.no](http://www.industrial.omron.no)

**Poland**

Tel: +48 (0) 22 645 78 60  
[www.industrial.omron.pl](http://www.industrial.omron.pl)

**Portugal**

Tel: +351 21 942 94 00  
[www.industrial.omron.pt](http://www.industrial.omron.pt)

**Russia**

Tel: +7 495 648 94 50  
[www.industrial.omron.ru](http://www.industrial.omron.ru)

**South-Africa**

Tel: +27 (0)11 579 2600  
[www.industrial.omron.co.za](http://www.industrial.omron.co.za)

**Spain**

Tel: +34 913 777 900  
[www.industrial.omron.es](http://www.industrial.omron.es)

**Sweden**

Tel: +46 (0) 8 632 35 00  
[www.industrial.omron.se](http://www.industrial.omron.se)

**Switzerland**

Tel: +41 (0) 41 748 13 13  
[www.industrial.omron.ch](http://www.industrial.omron.ch)

**Turkey**

Tel: +90 216 474 00 40  
[www.industrial.omron.com.tr](http://www.industrial.omron.com.tr)

**United Kingdom**

Tel: +44 (0) 870 752 08 61  
[www.industrial.omron.co.uk](http://www.industrial.omron.co.uk)

**More Omron representatives**  
[www.industrial.omron.eu](http://www.industrial.omron.eu)

**Automation Systems**

- Programmable logic controllers (PLC) • Human machine interfaces (HMI) • Remote I/O
- Industrial PC's • Software

**Motion & Drives**

- Motion controllers • Servo systems • Inverters

**Control Components**

- Temperature controllers • Power supplies • Timers • Counters • Programmable relays
- Digital panel indicators • Electromechanical relays • Monitoring products • Solid-state relays
- Limit switches • Pushbutton switches • Low voltage switch gear

**Sensing & Safety**

- Photoelectric sensors • Inductive sensors • Capacitive & pressure sensors
- Cable connectors • Displacement & width-measuring sensors • Vision systems
- Safety networks • Safety sensors • Safety units/relay units • Safety door/guard lock switches

## Данный компонент на территории Российской Федерации

### Вы можете приобрести в компании MosChip.

Для оперативного оформления запроса Вам необходимо перейти по данной ссылке:

<http://moschip.ru/get-element>

Вы можете разместить у нас заказ для любого Вашего проекта, будь то серийное производство или разработка единичного прибора.

В нашем ассортименте представлены ведущие мировые производители активных и пассивных электронных компонентов.

Нашей специализацией является поставка электронной компонентной базы двойного назначения, продукции таких производителей как XILINX, Intel (ex.ALTERA), Vicor, Microchip, Texas Instruments, Analog Devices, Mini-Circuits, Amphenol, Glenair.

Сотрудничество с глобальными дистрибьюторами электронных компонентов, предоставляет возможность заказывать и получать с международных складов практически любой перечень компонентов в оптимальные для Вас сроки.

На всех этапах разработки и производства наши партнеры могут получить квалифицированную поддержку опытных инженеров.

Система менеджмента качества компании отвечает требованиям в соответствии с ГОСТ Р ИСО 9001, ГОСТ РВ 0015-002 и ЭС РД 009

### Офис по работе с юридическими лицами:

105318, г.Москва, ул.Щербаковская д.3, офис 1107, 1118, ДЦ «Щербаковский»

Телефон: +7 495 668-12-70 (многоканальный)

Факс: +7 495 668-12-70 (доб.304)

E-mail: [info@moschip.ru](mailto:info@moschip.ru)

Skype отдела продаж:

moschip.ru

moschip.ru\_4

moschip.ru\_6

moschip.ru\_9